

# Interlaboratory study of standard methods for testing multiwire steel prestressing strand

Rémy D. Lequesne, William N. Collins, Enrico Lucon, David Darwin,  
and Ashwin Poudel

- This paper presents an interlaboratory study quantifying the variability of results of seven-wire low-relaxation steel prestressing strand tests conducted in accordance with ASTM A1061-16. The study included testing for strands with diameters of 0.375, 0.500, and 0.600 in. (9.5, 12.7, and 15.2 mm).
- Using samples produced by one supplier, the prestressing strands were tested by the various laboratories for yield strength, elastic modulus, breaking strength, and elongation. Test results from 19 laboratories were analyzed.
- Proposed changes to ASTM A1061-16 are presented with the aim of providing clarity to the standard, reducing the frequency of improper test procedures, and improving the test precision.

**M**ultiwire steel prestressing strand is widely used in precast and post-tensioned concrete construction. Although the mechanical properties of strand products are relatively invariant across production runs, it is necessary for producers and some end users, such as state departments of transportation, to document whether a given sample of strand complies with applicable specifications. Samples of strand are therefore frequently tested in tension in accordance with ASTM A1061, *Standard Test Methods for Testing Multi-Wire Steel Prestressing Strand*.<sup>1</sup> Problems occasionally arise when producers and end users obtain different results from tests of samples from the same strand. These problems can be difficult to resolve because the precision of the ASTM A1061 methods has not been previously quantified.

An interlaboratory study (ILS) was conducted to quantify the inter- and intralaboratory variability of results from tests of seven-wire low-relaxation steel strand samples in accordance with ASTM A1061-16.<sup>1</sup> Results from this ILS provide a basis for defining the precision of the test method, which is important to users needing to make informed decisions about material acceptance or rejection. The bias of this method, which is a quantity based on a comparison of results against an accepted reference value that is often reported alongside precision, cannot be determined because accepted reference values do not exist.

The ILS was conducted in accordance with ASTM E691-16, *Standard Practice for Conducting an Interlaboratory*

PCI Journal (ISSN 0887-9672) V. 65, No. 4, July–August 2020.

PCI Journal is published bimonthly by the Precast/Prestressed Concrete Institute, 8770 W. Bryn Mawr Ave., Suite 1150, Chicago, IL 60631.

Copyright © 2020, Precast/Prestressed Concrete Institute. The Precast/Prestressed Concrete Institute is not responsible for statements made by authors of papers in PCI Journal. Original manuscripts and discussion on published papers are accepted on review in accordance with the Precast/Prestressed Concrete Institute's peer-review process. No payment is offered.

*Study to Determine the Precision of a Test Method.*<sup>2</sup> It was designed to quantify the variability of four test outcomes: yield strength, elastic modulus, breaking strength, and elongation. Nineteen laboratories tested samples of Grade 270 (1860 MPa) low-relaxation seven-wire steel prestressing strand with diameters of 0.375, 0.500, and 0.600 in. (9.5, 12.7, and 15.2 mm). Samples of each strand diameter were sourced from the same coil of strand to minimize variations in material properties. Laboratories reported the measured yield strength, breaking strength, and elongation for at least three samples of each strand diameter. If it was recorded as part of data collection, laboratories also reported elastic modulus. Four of the 19 laboratories did not test 0.375 in. diameter strand due to lack of appropriate gripping devices. The research team vetted the submitted results for compliance with ASTM A1061-16<sup>1</sup> requirements, compiling sets of valid data.

The valid data were analyzed using statistical methods described in ASTM E691-16<sup>2</sup> to quantify the precision of the method. A precision statement is proposed for ASTM A1061<sup>1</sup> in accordance with ASTM E177-14, *Standard Practice for Use of the Terms Precision and Bias in ASTM Test Methods*,<sup>3</sup> and suggestions are made for improving the precision of the ASTM A1061 test method. Common errors committed during testing are described and recommendations are made for clarifying the ASTM A1061 standard. Other findings are also discussed, including effects of gripping-device type, yield strength measurement method, strand fracture location, and strand sample preparation.

## ASTM A1061 test method

ASTM A1061<sup>1</sup> describes methods used to measure the yield strength, breaking strength, elongation at fracture, and relaxation properties of steel prestressing strand specimens. Reporting elastic modulus is not required, but the standard does describe a method for determining the elastic modulus. Although included in ASTM A1061, relaxation properties were outside of the project scope and were not examined as part of the ILS because relaxation properties are assessed using a test that is distinct from the tension test examined in this study and would have required a distinct ILS protocol. Also, because relaxation properties are often not specified by purchasers, many laboratories that conduct the tension test examined in this study are not equipped to test strand relaxation properties.

ASTM A1061 is used for a variety of multiwire strands, including compacted, indented, and low-relaxation strands composed of two, three, or seven wires. Based on discussions with producers and precast concrete manufacturers, the standard is most often used for testing Grade 270 (1860 MPa) low-relaxation seven-wire steel strand compliant with ASTM A416, *Standard Specification for Low-Relaxation, Seven-Wire Steel Strand for Prestressed Concrete*.<sup>4</sup>

To conduct a test in accordance with ASTM A1061,<sup>1</sup> a sample of strand is tested in tension using a self-reacting frame as illustrated in **Fig. 1**. Three types of grips are permitted:

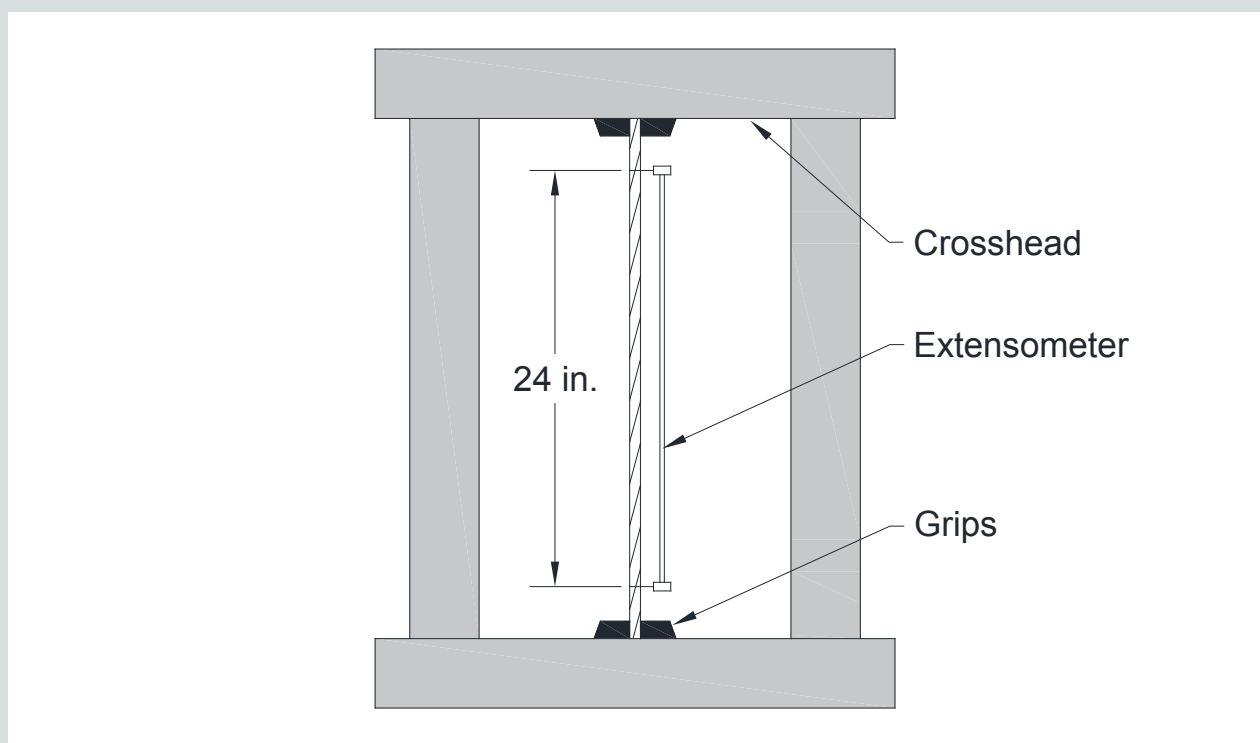

**Figure 1.** Schematic of test setup in a self-reacting frame. Note: 1 in. = 25.4 mm.

- V grips with serrated teeth, typically 16 teeth per 1 in. (25.4 mm)
- V grips with serrated teeth and a cushioning material, such as lead foil or aluminum foil, placed between the grips and the test specimen
- Grips with smooth, semicylindrical grooves (an abrasive slurry may be applied to the grips and specimen prior to testing to reduce slippage)

To reduce strand slippage, it is permitted to use chucking devices of the type used for applying tension to strands in casting beds or post-tensioning anchorages as a secondary gripping system in conjunction with the methods just described.

Yield strength may be determined using one of two methods, both illustrated in **Fig. 2**:

- Preload method: The specimen is loaded to 10% of the required minimum breaking strength  $S$ . While sustaining the force, an extensometer is attached to the specimen and adjusted to a reading of 0.1% of the extensometer gauge length. The force is then increased. The yield strength is defined as the force corresponding to an elongation of 1.0%.
- Elastic modulus extrapolation method: The elastic modulus of a specimen is the slope of a linear regression applied to at least 70% of the data collected between 20% and 65% (inclusive) of  $S$ . The intersection of the linear regression with the horizontal axis is defined as 0% elongation. Yield strength is defined as the force corre-

sponding to an elongation of 1.0% of the extensometer gauge length.

Elongation is determined using one of two methods:

- Preload method: The specimen is loaded to 10% of  $S$ . While sustaining the force, an extensometer is attached to the specimen and adjusted to a reading of 0% of the extensometer gauge length. The force is then increased until the measured elongation meets or exceeds the required minimum elongation (typically 3.5%) and the test is terminated. Note that the elongation corresponding to 10% of  $S$  (0%) is different from that specified for the preload method for yield strength (0.1%), making the two methods incompatible.
- Elongation after measuring yield strength method: The test is paused at an elongation of at least 1.05% for extensometer removal. The separation between the grips is then measured. The change in separation between grips or crossheads (both are permitted) at strand fracture is divided by the distance between the grips when the extensometer was removed and then added to the elongation (%) measured with the extensometer when it was removed. The requirement to physically measure the distance between grips (not crossheads) after determining yield strength makes it impossible to fully automate this method.

The breaking strength is taken as the maximum force sustained by the specimen during the test.

When a specimen fractures within a distance of 0.25 in. (6.4 mm) from the grips, results from the test are valid only

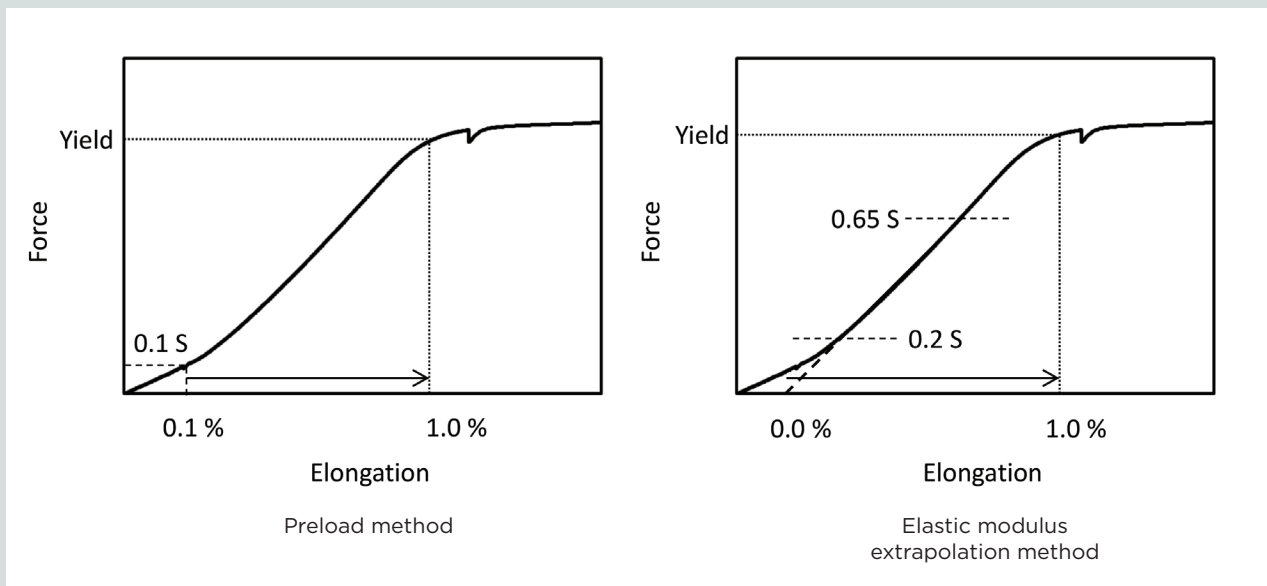

**Figure 2.** Illustrations of methods for determining yield strength using preload method and elastic modulus extrapolation method. Note:  $S$  = required minimum breaking strength.

if they exceed the required minimum breaking strength, yield strength, and elongation. This language is intended to include specimens that fracture anywhere within the grips or within a distance of 0.25 in. from the face of the grips. For brevity, *near the grips* will be used to represent this requirement. There is some confusion in practice about this requirement: Several technicians from this study reported that fracture location is irrelevant if necking (or cupping) is evident at the fracture point after testing. This is incorrect; the results of this study show that fracture location can influence measured results regardless of the shape of the fracture surface.

## ILS procedures

### Material selection

The ILS used Grade 270 (1860 MPa) low-relaxation seven-wire steel prestressing strand compliant with ASTM A416<sup>4</sup> requirements. Other types, such as indented, compacted, stress-relieved, stainless, and epoxy-coated strand produced in compliance with ASTM A779, *Standard Specification for Steel Strand, Seven-Wire, Uncoated, Compacted for Prestressed Concrete*;<sup>5</sup> ASTM A886, *Standard Specification for Steel Strand, Indented, Seven-Wire Stress-Relieved for Prestressed Concrete*;<sup>6</sup> or ASTM A910, *Standard Specification for Uncoated, Weldless, 2-Wire and 3-Wire Steel Strand for Prestressed Concrete*,<sup>7</sup> were outside the project scope. The scope was defined after conversations with strand producers and precast concrete manufacturers throughout the United States, who indicated that most strand in the domestic marketplace is ASTM A416<sup>4</sup> Grade 270 (1860 MPa).

The project included strands with 0.375, 0.500, and 0.600 in. (9.5, 12.7, and 15.2 mm) diameters. The two larger diameters were selected because conversations with strand producers and precast concrete manufacturers indicated that 0.500 and 0.600 in. diameter strands, which are typically used in structural applications, collectively account for approximately 85% of the U.S. market for strand. Strand with a 0.375 in. diameter was included because as the third most common strand size in the United States, it is commonly used in commercial precast concrete applications. It also allowed evaluation of whether the precision of the test method is sensitive to strand diameter.

### Laboratory selection

A brief questionnaire was sent to dozens of laboratories within the United States to screen potential participants. Based on the responses, 23 laboratories were selected to participate in the ILS. The selected laboratories reported having the equipment and experience necessary to conduct the test in accordance with ASTM A1061 requirements and expressed a willingness to participate. Participants included strand producer laboratories, state department of transportation laboratories, and independent commercial laboratories. It is believed that participants were reasonably representative of the domestic strand-testing industry.

## Procurement and distribution of specimens

Samples of 0.375, 0.500, and 0.600 in. (9.5, 12.7, and 15.2 mm) diameter strand were donated by domestic producers. All samples of strand with a single diameter were obtained from a single coil from a single producer. Producers cut the samples to length and then shipped them to the University of Kansas Laboratory.

Twenty-three laboratories were each sent a package containing five randomly selected samples of 0.5 and 0.6 in. diameter strands, a description of the study protocol, a detailed reporting form, a questionnaire, and ASTM requirements. In addition, the 17 laboratories equipped to test 0.375 in. diameter strand were sent five randomly selected samples of strand with that diameter. Each laboratory was asked to perform at least three tests for each strand size.

The reporting forms and the questionnaire<sup>8</sup> collected information necessary to evaluate compliance with ASTM A1061-16<sup>1</sup> requirements, including details of how the laboratory conducted each test, which measurements were made, and how test results were calculated. General information was also requested, including the type of testing equipment used, equipment calibration dates, and loading rates.

## Testing and results reporting

Of the 23 laboratories that were sent samples, 19 laboratories reported results. A member of the research team was present to witness testing at eight of the 19 laboratories (42%). Researchers recorded deviations from ASTM A1061-16<sup>1</sup> procedures but to avoid influencing results did not intervene. Deviations were used later as a basis for excluding results from the final data sets.

Laboratories documented their results by completing the reporting forms and questionnaire and, in many cases, submitting a summary of the test results. These summaries typically included plots of force versus elongation and a table listing the yield strength, elastic modulus, breaking strength, and elongation. Many laboratories also sent photographs of the test setup. Some laboratories provided point-by-point force-elongation data.

## Data compilation and removal of erroneous values

Submitted results were entered into spreadsheets for each test outcome and double-checked by a researcher who was not responsible for data entry. Data reported by technicians on questionnaires were cross-checked against computer-generated test result summaries when available. The value found on the computer-generated test result summary was retained wherever discrepancies were noted; these discrepancies were attributed to transcription errors. Approximately 2% of all reported values had this type of discrepancy.

In addition, some values (fewer than 1%) were clearly erroneous. Examples include an elongation at yield of 39,060 psi (269.3 MPa), elastic moduli of 11,600 ksi (80 MPa) and 1698 psi (11.7 MPa), and an elongation of 76.2%. These obvious errors were deleted. Values that were not clearly erroneous, including outliers, were retained.

## Determination of test procedure validity

Results obtained in a manner compliant with ASTM A1061-16<sup>1</sup> were considered valid. Values obtained otherwise were excluded from the data sets. Decisions to exclude data were based on observations made while witnessing the tests (for tests witnessed by a research team member) and/or responses provided to the research team (for all tests). Data were also excluded from the data sets when insufficient information was available to determine adherence to the standard.

It is possible that some results excluded from the data sets were valid. There is evidence that some technicians misunderstood the questionnaire and provided responses consistent with improper procedures even when their procedures were, in fact, acceptable. For example, one laboratory that used the preload method for yield strength reported that the extensometer was correctly mounted on the specimen at 0.1% elongation, but yield strength was incorrectly taken as the force corresponding to 1.1% elongation. However, because this laboratory also provided plots of the recorded data, it was determined that the reported yield strength actually corresponded to 1% elongation and was, therefore, a valid result. Had plots of the data not been provided, the results would have been excluded.

## Statistical analyses

The valid data were analyzed in accordance with ASTM E691-16<sup>2</sup> to determine the precision of the ASTM A1061-16<sup>1</sup> method for each test outcome. The following analyses were conducted for each test outcome and each strand size.

Because each laboratory reported results from three to five tests on each strand diameter, the first step was to calculate the mean  $\bar{x}_i$  and standard deviation  $s_i$  of the test results reported by the  $i$ th laboratory. This was done using Eq. (1) and (2).

$$\bar{x}_i = \frac{\sum_{j=1}^{n_i} x_{i,j}}{n_i} \quad (1)$$

$$s_i = \sqrt{\frac{\sum_{j=1}^{n_i} (x_{i,j} - \bar{x}_i)^2}{(n_i - 1)}} \quad (2)$$

where

$n_i$  = number of results reported by the  $i$ th laboratory

$i$  = index indicating laboratory number

$j$  = index indicating sample number from  $i$ th laboratory

$x_{i,j}$  =  $j$ th result from the  $i$ th laboratory

The mean  $\bar{x}$  and standard deviation  $s_{\bar{x}}$  of the laboratory means were calculated using Eq. (3) and (4).

$$\bar{x} = \frac{\sum_{i=1}^{P_L} \bar{x}_i}{P_L} \quad (3)$$

$$s_{\bar{x}} = \sqrt{\frac{\sum_{i=1}^{P_L} (\bar{x}_i - \bar{x})^2}{(P_L - 1)}} \quad (4)$$

where

$P_L$  = number of laboratories with valid results

To quantify the intralaboratory variability, the repeatability standard deviation  $s_r$  was calculated using Eq. (5). Many of the following calculations are more easily understood in terms of variance, which equals standard deviation squared. The value of  $s_r^2$ , therefore, equals the mean of the variances  $s_i^2$  calculated for results from each laboratory.

$$s_r = \sqrt{\frac{\sum_{i=1}^{P_L} s_i^2}{P_L}} \quad (5)$$

The repeatability limit  $r$ , a key finding of this study, was calculated using Eq. (6). It is defined in ASTM E177<sup>3</sup> as “the value below which the absolute difference between two individual test results obtained under repeatability conditions may be expected to occur with a probability of approximately 0.95 (95%).” Repeatability conditions refer to cases in which results from tests of nominally identical specimens are “obtained in the same laboratory by the same operator using the same equipment within short intervals of time.”

$$r = 2.8s_r \quad (6)$$

To quantify the interlaboratory variability, the between-laboratory standard deviation  $s_L$  was calculated with Eq. (7). Under repeatability conditions, a test method that is perfectly repeatable would have a repeatability standard deviation  $s_r$  equal to zero and therefore,  $s_L$  would equal  $s_{\bar{x}}$ . When  $s_r$  does not equal zero, which is typically the case,  $s_L < s_{\bar{x}}$  because some of the differences between laboratory means are attributable to variations under repeatability conditions.

$$s_L = \sqrt{s_{\bar{x}}^2 - \frac{s_r^2}{\min_{1 \leq i \leq P_L} n_i}} \quad (7)$$

The reproducibility standard deviation  $s_R$  was calculated with Eq. (8). The value of  $s_R^2$  is the variance observed between results from tests on a single material conducted by different technicians at different laboratories. It includes effects of both between-laboratory variability and the variability observed under repeatability conditions.

$$s_R = \sqrt{s_L^2 + s_r^2} \quad (8)$$

Another key finding of this study, the reproducibility limit  $R$ , was calculated using Eq. (9). It is defined in ASTM E177<sup>3</sup> as “the value below which the absolute difference between two test results obtained under reproducibility conditions may be expected to occur with a probability of approximately 0.95 (95%).” Reproducibility conditions refer to cases in which “test results are obtained with the same method on [nominally] identical test items in different laboratories with different operators using different equipment.”

$$R = 2.8s_R \quad (9)$$

To ensure that  $r$  and  $R$  are based on reliable data sets, ASTM E691<sup>2</sup> requires specific statistical tests to identify data that may be erroneous and warrant additional investigation and possible exclusion. This was done as described in Lequesne et al.<sup>8</sup>

## Results and analysis

### Equipment and procedures used by participating laboratories

**Testing equipment** Force was applied using self-reacting frames. Research team members observed tests performed with screw-type and hydraulically actuated frames with rated capacities of 120 to 600 kip (534 to 2670 kN). Several methods were employed for gripping strand specimens:

- Five laboratories used serrated V grips with approximately 16 teeth per 1 in. (25.4 mm) with nothing placed between the teeth and the strand. For those laboratories, 40 of 51 specimens (78%) fractured near the grips.
- One laboratory used serrated V grips with an aluminum cushioning material. One of nine specimens (11%) fractured near the grips.
- One laboratory used smooth cylindrical steel grips without pretreatment. Two of nine specimens (22%) fractured near the grips.
- Eight laboratories used smooth cylindrical grips combined with various methods to increase friction, including aluminum oxide, silica sand slurries, or metal shavings. For these laboratories, 20 of 75 specimens (27%) fractured near the grips.
- Three laboratories used cylindrical grips with a gritty tungsten-carbide coating welded to their surface. Fracture occurred near the grips for 11 of 31 specimens (35%). This type of grip is not explicitly addressed in ASTM A1061-16,<sup>1</sup> but it should be, given its popularity and the lower frequency of fracture near grips relative to serrated V grips without cushioning material, which had 78% of specimens fracture near grips.
- One laboratory reported using smooth cylindrical

aluminum grips with no pretreatment. None of the nine specimens (0%) fractured near the grips.

Two laboratories reported using secondary chucking devices in addition to one of the methods listed above to prevent strand slippage. It was reported anecdotally that some laboratories (not included in the study) use grips that are so worn that strand slip through the grips is inevitable. When these laboratories (outside the study) use secondary chucking devices, according to the anecdotal reports, it is common to observe strand fracture in the secondary chucking device, evidence that the chucking devices are improperly acting as primary gripping devices.

Most laboratories used a 24 in. (609.6 mm) extensometer (24 in. is the minimum length permitted by ASTM A106<sup>1</sup> for measuring elongation) that was typically clipped onto the strand specimen for elongation measurements up to the yield strength. Some of these laboratories used duct tape or hot glue between the extensometer blade and strand to reduce slippage. Two laboratories reported using extensometers with gauge lengths of 8 and 20 in. (203.2 and 508 mm). Per ASTM A1061,<sup>1</sup> results for yield strength and elastic modulus were excluded from the data sets when the lay length (the length of strand required for one of the seven wires to make a complete revolution around the strand perimeter) exceeded the extensometer gauge length.

Most laboratories used computer-recorded crosshead displacement to monitor elongation beyond 1%, though several reported using rulers and tape measures. Section 9.2.2 of ASTM A1061-16<sup>1</sup> indicates that the gauge length for elongation calculations after extensometer removal should be the distance between grips when the extensometer is removed. However, most laboratories automated this process and instead used either crosshead separation at yield or the separation between grips at the start of the test.

**Testing procedures** The preload method for yield strength was used by 11 of the 19 participating laboratories and 10 of the 11 laboratories that reported yield strengths classified as valid. Among the yield strengths measured using the preload and elastic modulus extrapolation methods, 91% and 50% were classified as valid, respectively.

Every laboratory in this study used the elongation after measuring yield strength method to determine elongation. This may not always be the case in practice, but it was the case here because laboratories were asked to test for both yield strength and elongation.

If test results exceed required minimum values, ASTM A1061<sup>1</sup> allows acceptance of the result regardless of strand fracture location. The data sets of valid results therefore include results from specimens that fractured either within the free length or near the grips because all recorded breaking strengths and elongations exceeded the minimum values required in ASTM A416.<sup>4</sup> These subgroups of results are treated jointly and separately in the subsequent sections, as appropriate.

## Reasons for excluding data from valid data sets

Out of 19 laboratories, a total of 14, 6, and 19 laboratories (74%, 32%, and 100%) reported results classified as valid for yield strength, elongation, and breaking strength, respectively. Of the 11 laboratories that reported values of elastic modulus, 9 (82%) had results classified as valid. As noted, some results excluded from the data sets might have been valid, but the research team did not have enough information to confirm compliance with the standard. Reasons for excluding data are described here; additional details are provided in Lequesne et al.<sup>8</sup>

Yield strengths and elastic moduli were excluded from the valid data sets (that is, not used for analysis) when a laboratory did one of the following:

- Two laboratories used an incorrect range of elongations to determine yield strength by means of the preload method (ASTM A1061-16<sup>1</sup> section 9.1.1).
- Two laboratories used an incorrect range of force to determine the elastic modulus when using the elastic modulus extrapolation method for yield strength (ASTM A1061-16<sup>1</sup> section 9.1.2).
- One laboratory set the elastic modulus to a fixed value for all specimens. Plotted results submitted to the research team clearly showed that the assumed value was incorrect for some specimens.
- One laboratory used an incorrect gauge length in the calculation of elongation, and the correct gauge length was not reported so elongation values could not be recalculated.
- One laboratory allowed the extensometer to slip relative to the specimen and made no correction.
- One laboratory reported using an extensometer with a gauge length that was shorter than the lay length of the 0.5 and 0.6 in. (12.7 and 15.2 mm) diameter strand samples.
- One laboratory reported using an extensometer that did not meet the requirements of ASTM E83<sup>9</sup> for B-1 classification.

For elongation results to be valid, 1% elongation must be correctly determined, effectively requiring a valid determination of yield strength. Elongation results were, therefore, excluded when the corresponding yield strength results were excluded. Elongation results were also excluded when a laboratory did one of the following:

- Two laboratories used an incorrect gauge length to calculate elongation from measured crosshead displacement

values. This occurred when, for instance, technicians divided the crosshead displacement by 24 in. (609.6 mm), the gauge length of the extensometer, not the distance between grips.

- One laboratory reported elongation values recorded by the software immediately after breakage when crosshead displacement measurements were erratic and large due to the energy released by strand fracture.
- Two laboratories used extensometers with gauge lengths shorter than 24 in. (609.6 mm).

No reported values of breaking strength were excluded from the valid data sets.

## Summary of valid test results

Valid results for each test outcome were received for each strand diameter from a minimum of six laboratories, which satisfies the minimum requirement of ASTM E691<sup>2</sup> for establishing a precision statement. The valid results are summarized in **Table 1**. The mean, coefficient of variation (standard deviation divided by mean), and range are shown for the valid reported values of each test outcome. The results are presented separately for 0.375, 0.500, and 0.600 in. (9.5, 12.7, and 15.2 mm) diameter strands. In addition, Table 1 also includes the number of results, the number of valid results, and the number of laboratories that reported valid results for each strand diameter and parameter. The number of valid results is not three times the number of laboratories because some laboratories reported more than three valid results and others had one or two excluded results. The mean of valid data received from each laboratory  $\bar{x}_i$  is plotted for each test outcome in **Fig. 3** as the difference between  $\bar{x}_i$  and the mean of valid results.

Table 1 and Fig. 3 show that yield strength and breaking strength were consistent within the population of valid results, with coefficients of variation less than 1.5% and 1.0%, respectively. Valid results for elastic modulus showed somewhat more variability, with coefficients of variation between 1.4% and 3.0% for the different strand diameters. Elongation results, however, exhibited significant variability among laboratories, resulting in coefficients of variation close to 17%.

Variability was not correlated with strand size. Coefficients of variation for yield strength, elastic modulus, elongation, and breaking strength were largest for the 0.375, 0.500, 0.600, and 0.375 in. (9.5, 12.7, 15.2, and 9.5 mm) diameter strand samples, respectively.

## Precision of the ASTM A1061-16 method

The statistical analyses previously described were applied to the data sets of valid results. The resulting precision statistics are listed in **Tables 2** through **5** for yield strength, elastic modulus, elongation, and breaking strength, respectively. There is a 95% probability that test results will differ by not more than the

**Table 1.** Summary of valid results

Strand diameter, in.		0.375	0.500	0.600
Yield strength	Mean, lb	23,083	38,816	55,818
	COV, %	1.32	0.983	1.16
	Minimum, lb	22,550	38,118	54,828
	Maximum, lb	23,850	40,128	57,967
	Number of reported results	52	66	66
	Number of valid results	35	39	40
	Number of laboratories with valid results	11	12	12
Elastic modulus	Mean, ksi	29,233	29,594	29,102
	COV, %	1.41	2.99	2.80
	Minimum, ksi	28,500	28,700	27,400
	Maximum, ksi	30,000	32,300	30,970
	Number of reported results	30	40	40
	Number of valid results	19	23	26
	Number of laboratories with valid results	6	7	8
Elongation	Mean, %	6.30	6.55	6.18
	COV, %	17.6	16.9	17.7
	Minimum, %	4.90	4.95	4.40
	Maximum, %	8.80	8.80	7.80
	Number of reported results	52	66	66
	Number of valid results	20	20	20
	Number of laboratories with valid results	6	6	6
Breaking strength	Mean, lb	25,759	43,803	61,949
	COV, %	0.934	0.802	0.740
	Minimum, lb	25,000	43,132	60,680
	Maximum, lb	26,300	44,700	62,900
	Number of reported results	52	66	66
	Number of valid results	52	66	66
	Number of laboratories with valid results	15	19	19

Note: Mean, coefficient of variation, minimum, and maximum are reported for valid results only. COV = coefficient of variation. 1 in. = 25.4 mm; 1 lb = 4.448 kN; 1 ksi = 6.895 MPa.

repeatability limit  $r$  if they are obtained from tests of nominally identical specimens conducted by a single technician with the same equipment. Similarly, there is a 95% probability that test results will differ by not more than the reproducibility limit  $R$  if they are obtained from tests of nominally identical specimens conducted by different technicians with different equipment.

While  $R \geq r$  for all cases, Tables 2, 3, and 5 show that  $r$  and  $R$  were somewhat similar in magnitude for yield strength, elastic modulus, and breaking strength. For these measures, a large portion of the differences among results obtained at different

laboratories was, therefore, due to variability in results that would be observed among tests conducted under repeatability conditions. Table 4 shows this was not the case for elongation, where  $R$  was between 2.2 and 3.7 times greater than  $r$ . These large differences between  $r$  and  $R$  indicate that results obtained at different laboratories differed by much more than would be expected under repeatability conditions. Different laboratories frequently obtained notably different elongation results for the same material, even when the tests were conducted in accordance with ASTM A1061-16.<sup>1</sup> It seems likely that the reproducibility limit for elongation would be reduced



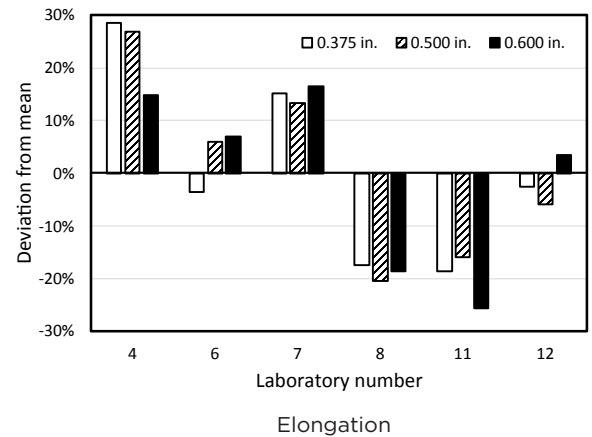
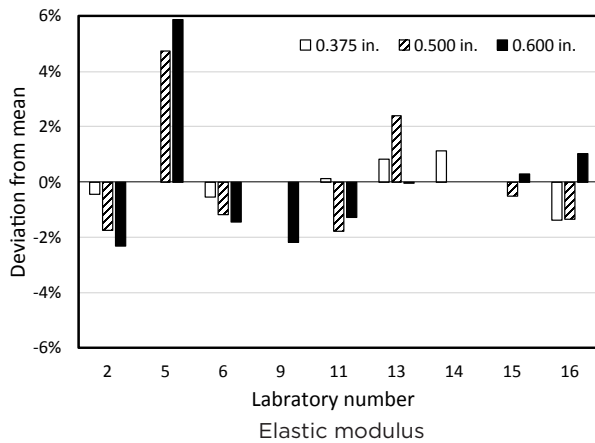
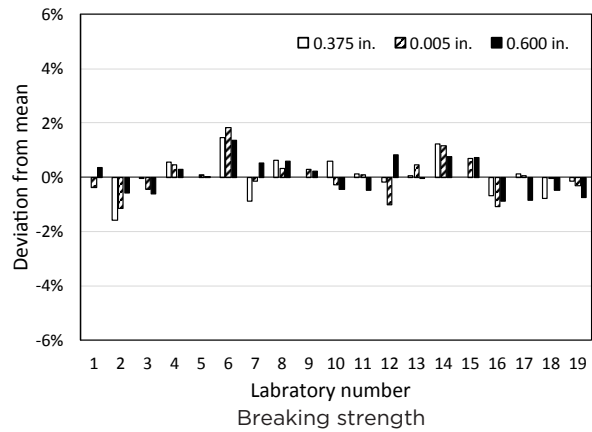
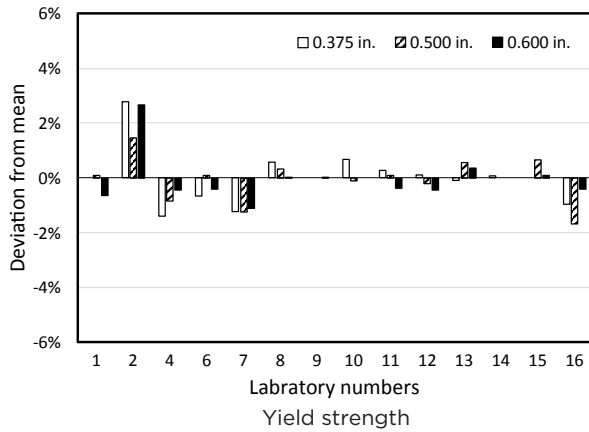

**Figure 3.** Mean of results from each laboratory for yield strength, breaking strength, elastic modulus, and elongation for pre-stressing strand diameters of 0.375, 0.500, and 0.600 in. Note: 1 in. = 25.4 mm.

**Table 2.** Precision statistics for yield strength

Strand diameter, in.	Mean of laboratory means $\bar{x}$ , lb	Repeatability standard deviation $s_r$ , lb	Reproducibility standard deviation $s_R$ , lb	Repeatability limit $r$ , lb	Reproducibility limit $R$ , lb
0.375	23,087	208.8	304.9	585	854
0.500	38,792	222.7	350.2	624	981
0.600	55,785	397.3	615.7	1110	1720

Note: 1 in. = 25.4 mm; 1 lb = 4.448 kN.

**Table 3.** Precision statistics for elastic modulus

Strand diameter, in.	Mean of laboratory means $\bar{x}$ , $10^3$ ksi	Repeatability standard deviation $s_r$ , $10^3$ ksi	Reproducibility standard deviation $s_R$ , $10^3$ ksi	Repeatability limit $r$ , $10^3$ ksi	Reproducibility limit $R$ , $10^3$ ksi
0.375	29.22	0.396	0.423	1.1	1.2
0.500	29.62	0.820	0.943	2.3	2.6
0.600	29.10	0.497	0.874	1.4	2.5

Note: 1 in. = 25.4 mm; 1 ksi = 6.895 MPa.

**Table 4.** Precision statistics for elongation

Strand diameter, in.	Mean of laboratory means $\bar{x}$ , %	Repeatability standard deviation $s_r$ , %	Reproducibility standard deviation $s_R$ , %	Repeatability limit $r$ , %	Reproducibility limit $R$ , %
0.375	6.32	0.44	1.22	1.2	3.4
0.500	6.59	0.33	1.21	0.92	3.4
0.600	6.16	0.53	1.17	1.5	3.3

Note: 1 in. = 25.4 mm.

**Table 5.** Precision statistics for breaking strength

Strand diameter, in.	Mean of laboratory means $\bar{x}$ , lb	Repeatability standard deviation $s_r$ , lb	Reproducibility standard deviation $s_R$ , lb	Repeatability limit $r$ , lb	Reproducibility limit $R$ , lb
0.375	25,768	151.7	241.6	425	677
0.500	43,819	189.1	357.4	530	1000
0.600	61,967	235.7	452.6	660	1270

Note: 1 in. = 25.4 mm; 1 lb = 4.448 kN.

if the ASTM A1061 procedure for testing elongation were made more prescriptive.

Figure 4 is a plot of  $R/\bar{x}$  for each strand diameter and test outcome (lines between data points are for readability and do not represent trends). For yield strength and breaking strength,  $R/\bar{x}$  was less than 4% and 3%, respectively. For elastic modulus,  $R/\bar{x}$  was between 4% and 9%. These small  $R/\bar{x}$  values reflect relatively small variability in yield strength, breaking strength, and elastic modulus results collected in accordance with ASTM A1061.<sup>1</sup> This was not the case for elongation, for which  $R/\bar{x}$  varied between 51% and 54%. Such large reproducibility limits may compromise the utility of elongation measurements. A strand producer would need to produce strand that consistently has measured elongations larger than

7% to achieve a 95% probability that another laboratory will not measure an elongation less than 3.5%, the required minimum elongation, and then reject the strand.

## Differences among subgroups of test results

**Preload method versus elastic modulus extrapolation method for determining yield strength** The percentage of results classified as valid was different between the two methods for determining yield strength. As described, 91% and 50% of results were classified as valid when obtained with the preload and elastic modulus extrapolation methods, respectively. Changes to ASTM A1061<sup>1</sup> that clarify the requirements for the elastic modulus extrapolation method may improve this.

Table 6 shows the precision statistics calculated for subgroups of yield strength data obtained using either the preload or elastic modulus extrapolation methods, including  $\bar{x}$ ,  $s_r$ ,  $s_R$ ,  $r$ , and  $R$ , as well as mean and coefficient of variation for all valid results. Differences among the means for all valid results were small for all three strand diameters, with yield strengths obtained using the preload method between 0.1% and 0.3% larger than those obtained with the elastic modulus extrapolation method. The statistical significance of differences observed between subsets of results obtained using the two methods was assessed using a two-tailed Student's *t*-test. To apply Student's *t*-test, the probability *p* of obtaining a difference in average strengths at least as large as the observed difference was calculated assuming that there was no difference.<sup>10</sup> A *p* value less than or equal to 0.05 indicates that the difference between two subsets of results is statistically significant. On this basis, the differences were not statistically significant, with *p* values of 0.44, 0.51, and 0.76 for 0.375, 0.500, and 0.600 in. (9.5, 12.7, and 15.2 mm) diameter strand, respectively.

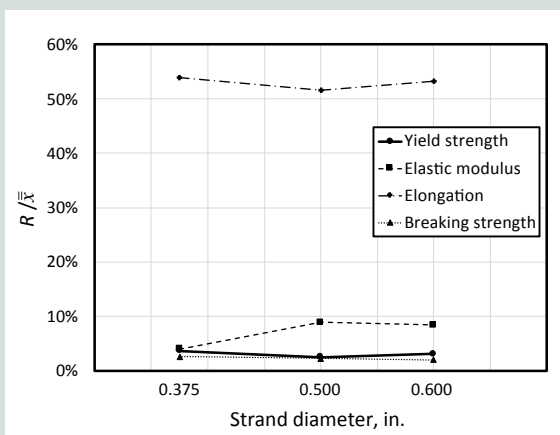

**Figure 4.** Reproducibility limit  $R$  divided by the mean of laboratory means  $\bar{x}$  for each strand diameter and test outcome. Note: 1 in. = 25.4 mm.

**Table 6.** Comparison of precision statistics for yield strength obtained using the preload and elastic modulus extrapolation methods

Strand diameter, in.	0.375		0.500		0.600	
	PL	EM	PL	EM	PL	EM
Method for yield strength determination	PL	EM	PL	EM	PL	EM
Number of laboratories $P_L$	8	3*	8	3*	8	4*
Mean of laboratory means $\bar{x}$ , lb	23,110	23,030	38,830	38,680	55,800	55,760
Repeatability standard deviation $s_p$ , lb	210	206	251	118	411	368
Reproducibility standard deviation $s_R$ , lb	340	223	387	471	724	368
Repeatability limit $r$ , lb	589	576	703	331	1150	1030
Reproducibility limit $R$ , lb	951	625	1080	1320	2030	1030
Mean of valid results, <sup>†</sup> lb	23,100	23,030	38,850	38,750	55,840	55,780
Coefficient of variation, %	1.44	0.99	0.99	1.04	1.35	0.64
Probability $p^\ddagger$	0.44		0.50		0.76	

Note: EM = yield strength results obtained using the elastic modulus extrapolation method; PL = yield strength results obtained using the preload method. 1 in. = 25.4 mm; 1 lb = 4.448 kN.

\*Interpret results based on fewer than six laboratories with caution because they may not be representative of larger populations of laboratories.

†Not necessarily equal to  $\bar{x}$  because the number of valid results from each laboratory was not constant.

‡Probability of obtaining a difference at least as large as that observed between two data sets. Results are from a two-tailed Student's t-test; values  $\leq 0.05$  indicate that differences are statistically significant.

Table 6 shows that there were large but inconsistent differences in the variability of results obtained using the two methods, with the preload method having a much larger  $R$  for 0.375 and 0.600 in. diameter strands and a much smaller  $R$  for the 0.500 in. diameter strand. No indication was obtained about which method provided less scatter in the results.

**Effect of the location of strand fracture** To evaluate whether fracture location affected the valid results, precision statistics were calculated for elongation and breaking strength for subgroups of data obtained from tests in which the strand specimens fractured either near the grips or away

from the grips. **Table 7** shows  $\bar{x}$ ,  $s_p$ ,  $s_R$ ,  $r$ , and  $R$ , as well as mean and coefficient of variation, for all valid results. Results for elongation and breaking strength are compared for these subgroups in **Fig. 5** in terms of  $\bar{x}$  and  $R$ , respectively (as with Fig. 4, lines between data points are for readability and do not represent trends). Comparisons are not made for yield strength and elastic modulus results because strand fracture location has no effect on these measures.

Figure 5 shows that strand fracture location had a large effect on elongation but little effect on mean reported breaking strength. Reported elongations for 0.375 and 0.500 in. (9.5

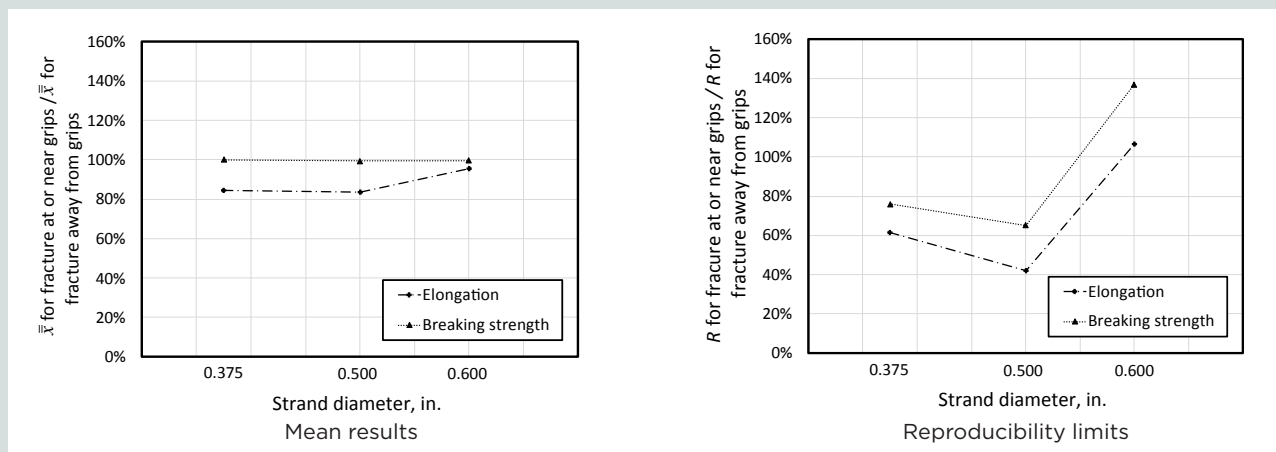

**Figure 5.** Comparisons of subgroups of test data with fracture occurring near the grips versus fracture occurring away from the grips for mean results and reproducibility limits. Note: Elongation data include results from fewer than six laboratories.  $R$  = reproducibility limit;  $\bar{x}$  = mean of laboratory means. 1 in. = 25.4 mm.

**Table 7.** Comparison of precision statistics for elongation and breaking strength for subgroups of specimens fracturing near the grips and specimens fracturing away from the grips

Strand diameter, in.	Statistical parameter	Elongation, %		Breaking strength, lb	
		Away*	Near†	Away*	Near†
0.375	Number of laboratories $P_L^\ddagger$	4 <sup>§</sup>	2 <sup>§</sup>	11	6
	Mean of laboratory means $\bar{x}$	6.664	5.637	25,770	25,800
	Repeatability standard deviation $s_r$	0.420	0.480	152	123
	Reproducibility standard deviation $s_R$	1.32	0.813	245	186
	Repeatability limit $r$	1.18	1.35	425	343
	Reproducibility limit $R$	3.70	2.28	686	521
	Mean of valid results, <sup>  </sup> lb	6.664	5.763	25,750	25,770
	Coefficient of variation, %	18.1	12.3	1.07	0.69
	Probability $p^{**}$	0.050		0.67	
0.500	Number of laboratories $P_L^\ddagger$	4 <sup>§</sup>	2 <sup>§</sup>	12	9
	Mean of laboratory means $\bar{x}$	6.967	5.830	43,920	43,660
	Repeatability standard deviation $s_r$	0.306	0.373	180	161
	Reproducibility standard deviation $s_R$	1.32	0.557	375	244
	Repeatability limit $r$	0.857	1.04	505	451
	Reproducibility limit $R$	3.71	1.56	1050	684
	Mean of valid results, <sup>  </sup> lb	6.967	5.913	43,930	43,630
	Coefficient of variation, %	17.3	8.83	0.78	0.65
	Probability $p^{**}$	0.016		0.00025	
0.600	Number of laboratories $P_L^\ddagger$	4 <sup>§</sup>	4 <sup>§</sup>	14	10
	Mean of laboratory means $\bar{x}$	6.493	6.197	62,070	61,930
	Repeatability standard deviation $s_r$	0.492	0.430	180	267
	Reproducibility standard deviation $s_R$	1.06	1.13	374	513
	Repeatability limit $r$	1.38	1.20	505	749
	Reproducibility limit $R$	2.96	3.15	1050	1440
	Mean of valid results, <sup>  </sup> lb	6.408	5.959	62,040	61,810
	Coefficient of variation, %	16.7	18.9	0.60	0.89
	Probability $p^{**}$	0.37		0.074	

Note: 1 in. = 25.4 mm; 1 lb = 4.448 kN.

\*Results are from specimens fracturing away from the grips.

†Results are from specimens fracturing near the grips.

‡The sum in columns Away and Near may not equal the number of laboratories because some laboratories had some specimens fracture near the grips and other specimens fracture away from the grips.

§Interpret results based on fewer than six laboratories with caution because they may not be representative of larger populations of laboratories.

||Not necessarily equal to  $\bar{x}$  because the number of valid results from each laboratory was not constant.

\*\*Probability of obtaining a difference at least as large as that observed between two data sets. Results are from a two-tailed Student's  $t$ -test; values  $\leq 0.05$  indicate that differences are statistically significant.

and 12.7 mm) diameter specimens that fractured near the grips were approximately 15% less than for other specimens. Table 7 shows that these differences were statistically significant, with  $p = 0.050$  and  $0.016$  for 0.375 and 0.500 in. diameter strands. Reported elongations were 7% less for 0.600 in. (15.2 mm) diameter strands fracturing near the grips, but this difference was not statistically significant ( $p = 0.074$ ). Tests with specimens fracturing near the grips (inside or within 0.25 in. [6.4 mm] of the grips), which is a common occurrence when serrated grips are used to grip the strand, should not be used to disqualify the strand on the basis of measured elongation. Table 7 shows that strand fracture location had a small and statistically significant ( $p = 0.00025$ ) effect on the breaking strength of 0.500 in. diameter strands but no statistically significant effect on breaking strength for 0.375 and 0.600 in. diameter strands ( $p = 0.68$  and  $0.074$ , respectively). Overall, the effect of strand fracture location on breaking strength can be considered negligible.

Figure 5 also shows that the reproducibility limit was smaller for 0.375 and 0.500 in. (9.5 and 12.7 mm) strand and larger for 0.600 in. (15.2 mm) strand for subgroups of specimens that fractured near the grips compared with specimens that fractured away from the grips. This was true for both elongation and breaking strength. There was, therefore, no consistent correlation between strand fracture location and the variability of elongation and breaking strength results.

Although tests with strands fracturing near the grips are valid per ASTM A1061<sup>1</sup> if the results exceed required minimums, it is worth considering whether removing specimens that fractured near the grips would improve the high values for  $R$

calculated for elongation in Table 4. Lequesne et al.<sup>8</sup> shows that no consistent reduction in  $R$  occurs when considering only specimens fracturing away from the grips. There are, however, too few data satisfying this condition to draw any substantive conclusion.

**Effect of welding strand ends** Of the 19 laboratories participating in the study, only one laboratory, referred to as laboratory 6, welded the ends of all strand samples prior to testing. This is a standard practice at laboratory 6 aimed at increasing the likelihood that strand fracture occurs by simultaneous fracturing of all seven wires away from the grips. At other laboratories, it was typical for strand fracture to correspond to fracture of a single wire. ASTM A1061<sup>1</sup> does not prohibit welding the ends of strands, so these results were not excluded from the data sets of valid results.

To determine the effect of welding, results from laboratory 6 were compared with results obtained using similar procedures but without welding strand ends. **Table 8** shows that there was no statistically significant effect of welded strand ends on yield strength ( $p = 0.42, 0.95, 0.27$  for 0.375, 0.500, and 0.600 in. [9.5, 12.7, and 15.2 mm] diameter strands, respectively). Similarly, welded strand ends had no effect on reported elongation values when only results from specimens fracturing away from the grips were considered ( $p = 0.13, 0.94, 0.51$  for 0.375, 0.500, and 0.600 in. diameter strands, respectively). Only strands fracturing away from the grips were considered because eight of nine tests reported by laboratory 6 had strand fracture occur away from the grips. Specimens with welded ends did exhibit breaking strengths that were 5.7%, 1.7%, and 1.3% higher

**Table 8.** Effects of welding strand ends on yield strength, elongation, and breaking strength

Strand diameter, in.	Statistical parameter	Yield strength, lb		Elongation, %		Breaking strength, lb	
		Lab 6	$P_L$	Lab 6	Away*	Lab 6	Away*
0.375	Number of laboratories $P_L$	1 <sup>†</sup>	7	1 <sup>†</sup>	3 <sup>†</sup>	1 <sup>†</sup>	9
	Mean of valid results, lb	22,930	23,130	6.083	6.858	26,130	25,710
	Coefficient of variation, %	1.53	1.44	0.84	19.7	0.59	0.99
	Probability $p^\ddagger$	0.42		0.13		0.024	
0.500	Number of laboratories $P_L$	1 <sup>†</sup>	7	1 <sup>†</sup>	3 <sup>†</sup>	1 <sup>†</sup>	10
	Mean of valid results, lb	38,850	38,840	6.940	6.976	44,600	43,870
	Coefficient of variation, %	0.48	1.04	3.41	20.2	0.22	0.67
	Probability $p^\ddagger$	0.95		0.94		0.000074	
0.600	Number of laboratories $P_L$	1 <sup>†</sup>	7	1 <sup>†</sup>	3 <sup>†</sup>	1 <sup>†</sup>	13
	Mean of valid results, lb	55,890	55,870	6.650	6.348	62,800	62,000
	Coefficient of variation, %	0.54	1.41	1.28	19.0	0.23	0.54
	Probability $p^\ddagger$	0.27		0.51		0.019	

Note:  $P_L$  = valid yield strength results obtained using the preload method, excluding results from laboratory 6. 1 in. = 25.4 mm; 1 lb = 4.448 kN.

\*Valid results from specimens fracturing away from the grips, excluding results from laboratory 6.

<sup>†</sup>Interpret results based on fewer than six laboratories with caution, as they may not be representative of larger populations of laboratories.

<sup>‡</sup>Probability of obtaining a difference at least as large as that observed between two data sets. Results are from a two-tailed Student's  $t$ -test; values 0.05 indicate that differences are statistically significant.

than the mean result for strands without welded ends for 0.375, 0.500, and 0.600 in. diameter strands, respectively. Considering only results where strands fractured away from the grips, these differences were statistically significant ( $p = 0.024$ , 0.000074, and 0.019 for 0.375, 0.500, and 0.600 in. diameter strands, respectively). Based on the higher breaking strength, welding strand ends is not recommended. If the results from laboratory 6 were excluded from the data sets, the calculated precision statistics reported in Tables 2 through 5 would change, as reported in Lequesne et al.<sup>8</sup> Omitting data from laboratory 6 caused the reproducibility limit  $R$  to increase by up to 10% for yield strength and elastic modulus and decrease by up to 13% for breaking strength. The largest effect, however, of omitting data from laboratory 6 is that a precision statement could not be proposed for elongation because valid elongation data would then be sourced from fewer than six laboratories, the minimum required by ASTM E691.<sup>2</sup>

## Recommended changes to ASTM A1061

Based on the analyses described in this paper, several changes to ASTM A1061<sup>1</sup> are proposed to clarify the standard, reduce the frequency of improperly conducted tests, and improve the test precision. In addition, a detailed description of proposed changes is provided in Lequesne et al.<sup>8</sup> Section numbers refer to ASTM A1061-16.

- Section 7: Explicitly permit the use of grips with semi-cylindrical grooves coated with a welded-on textured coating. Serrated V grips without cushioning material should not be permitted.
- Section 9.1: Several editorial changes are suggested with the aim of clarifying the range of elongations and forces used to determine yield strength when using the preload and elastic modulus extrapolation methods, respectively. Editorial changes that clarify which gauge length to use are also proposed.
- Section 9.2: If industry stakeholders find the large values for  $R$  and high rate of noncompliance for elongation measurements unacceptable, several changes should be considered, including the following:
  - providing a simple method for automating the elongation after measuring yield strength method
  - more clearly prescribing requirements, such as which gauge length should be used when calculating elongation and at which elongation the extensometer should be removed
- Section 9.3: Clearly state the following:
  - Test results from specimens that fracture within secondary chucking devices shall be invalid.
  - Necking (or cupping) at the fracture point is not evidence that the gripping device had no effect on test results and should not be used as a basis for determining test validity.

- Section 11: Insert a precision statement that briefly summarizes the ILS, as required by ASTM, and insert the precision statistics obtained for each of the measured mechanical parameters. These are provided in Table 2 (yield strength), Table 3 (elastic modulus), Table 4 (elongation), and Table 5 (breaking strength).

## Conclusion

Rates of compliance among participating laboratories with ASTM A1061-16<sup>1</sup> requirements were low for several parameters, indicating the need for clarifying and simplifying requirements. Among laboratories reporting results, 74%, 82%, 32%, and 100% reported valid results for yield strength, elastic modulus, elongation, and breaking strength, respectively.

Measurements of yield strength and breaking strength had low variability, resulting in reproducibility limits less than 4% of the mean value. Elastic modulus measurements exhibited more variability, with reproducibility limits up to 9% of the mean value. The variability of elongation measurements was high, resulting in reproducibility limits near 50% of the mean reported value.

The variability of reported results was not correlated with strand size for any test parameter.

Yield strengths determined using the preload and elastic modulus extrapolation methods exhibited no statistically significant difference. However, 91% and 50% of results were classified as valid for the preload and elastic modulus extrapolation methods, respectively, indicating a difference between the two methods in terms of rates of compliance with the standard.

Strand fracture within the grips or within a distance of 0.25 in. (6.4 mm) of the grips resulted in negligible changes in breaking strength but statistically significant reductions in measured elongation of up to 15%.

The type of grips used affected the percentage of specimens that fractured near the grips. V grips without cushioning material resulted in the highest frequency of fracture near the grips (78%), while all other methods resulted in fewer than 35% of specimens fracturing near the grips. V grips without cushioning material should, therefore, not be permitted.

Several laboratories used cylindrical grips with a gritty tungsten-carbide coating welded to the surface. Given their prevalence and the satisfactory observed performance, such grips should be permitted.

Welding the ends of strands, which was done by one laboratory, correlated with more frequent simultaneous fracture of all strand wires. Welding strand ends had no effect on yield strength or elongation but did result in a statistically significant increase in breaking strength between 1.3% and 5.7%. Because consistency in material characterization methodologies is im-

perative and not welding strand ends is the industry standard, it is recommended that welding strand ends not be permitted.

## Acknowledgments

Primary financial support was provided by PCI. The strands used in this study were donated by Insteel Wire Products, Sumiden Wire Products Corp., and Wire Mesh Corp. Testing was performed by laboratories at Bekaert Corp.; CTL Group; Insteel Wire Products; Sumiden Wire Products Corp.; Wire Mesh Corp.; Wiss, Janney, Elstner Associates Inc.; and departments of transportation in California, Georgia, Illinois, Missouri, Montana, Nevada, Pennsylvania, Tennessee, and Texas.

## References

1. ASTM International. 2016. *Standard Test Methods for Testing Multi-Wire Steel Prestressing Strand*. ASTM A1061/A1061M-16. West Conshohocken, PA: ASTM International.
2. ASTM International. 2016. *Standard Practice for Conducting an Interlaboratory Study to Determine the Precision of a Test Method*. ASTM E691-16. West Conshohocken, PA: ASTM International.
3. ASTM International. 2014. *Standard Practice for Use of the Terms Precision and Bias in ASTM Test Methods*. ASTM E177-14. West Conshohocken, PA: ASTM International.
4. ASTM International. 2017. *Standard Specification for Low-Relaxation, Seven-Wire Steel Strand for Prestressed Concrete*. ASTM A416/A416M-17a. West Conshohocken, PA: ASTM International.
5. ASTM International. 2016. *Standard Specification for Steel Strand, Seven-Wire, Uncoated, Compacted for Prestressed Concrete*. ASTM A779/A779M-16. West Conshohocken, PA: ASTM International.
6. ASTM International. 2017. *Standard Specification for Steel Strand, Indented, Seven-Wire Stress-Relieved for Prestressed Concrete*. ASTM A886/A886M-17. West Conshohocken, PA: ASTM International.
7. ASTM International. 2018. *Standard Specification for Uncoated, Weldless, 2-Wire and 3-Wire Steel Strand for Prestressed Concrete*. ASTM A910/A910M-18. West Conshohocken, PA: ASTM International.
8. Lequesne, R. D., W. Collins, E. Lucon, A. Poudel, and D. Darwin. 2019. *Development of a Precision Statement for ASTM A1061*. SM report 131. Lawrence, KS: University of Kansas Center for Research.
9. ASTM International. 2016. *Standard Practice for Verification and Classification of Extensometer Systems*. ASTM E83-16. West Conshohocken, PA: ASTM International.

10. Johnson, R. A., I. Miller, and J. E. Freund. 2005. *Probability and Statistics for Engineers*. 7th ed. Englewood Cliffs, NJ: Pearson Prentice Hall.

## Notation

$i$	= index indicating laboratory number
$j$	= index indicating sample number from $i$ th laboratory
$n_i$	= number of results reported by $i$ th laboratory
$p$	= probability of obtaining a difference at least as large as that observed between two sets of data, assuming there is no difference between the datasets
$P_L$	= number of laboratories with valid results
$r$	= repeatability limit, the value below which the absolute difference between two individual test results obtained under repeatability conditions may be expected to occur with a probability of approximately 0.95 (95%) (ASTM E177 <sup>3</sup> )
$R$	= reproducibility limit, the value below which the absolute difference between two test results obtained under reproducibility conditions may be expected to occur with a probability of approximately 0.95 (95%) (ASTM E177 <sup>3</sup> )
$s_i$	= standard deviation of results reported by $i$ th laboratory
$s_L$	= between-laboratory standard deviation; the sample standard deviation attributable to differences of test result means among laboratories (ASTM E177 <sup>3</sup> )
$s_r$	= repeatability standard deviation; the standard deviation of test results obtained under repeatability conditions (ASTM E177 <sup>3</sup> )
$s_R$	= reproducibility standard deviation; the standard deviation of test results obtained under reproducibility conditions (ASTM E177 <sup>3</sup> )
$s_{\bar{x}}$	= standard deviation of laboratory means
$S$	= specified minimum breaking strength
$x_{i,j}$	= $j$ th individual test result from $i$ th laboratory; the value of a characteristic obtained by carrying out a specified test method (ASTM E177 <sup>3</sup> )
$\bar{\bar{x}}$	= mean of laboratory means
$\bar{x}_i$	= mean of results reported by $i$ th laboratory

## About the authors

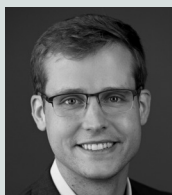

Rémy D. Lequesne, PhD, PE, is associate professor of civil, environmental, and architectural engineering at the University of Kansas, Lawrence, Kans. He is a member of the PCI Prestressing Reinforcement Committee. His research interests

include characterization of materials for use in precast and reinforced concrete systems.



William Collins, PhD, PE, is assistant professor of civil, environmental, and architectural engineering at the University of Kansas. He is a member of ASTM Committees E28, Mechanical Testing, and E08, Fatigue and Fracture. His research

interests include the mechanical behavior and structural performance of metallic materials, components, and systems.



Enrico Lucon, PhD, is a nuclear engineer and the Charpy Machine Verification Program leader at the National Institute of Standards and Technology in Boulder, Colo. He is a member of ASTM Committees E28, Mechanical Testing; E08,

Fatigue and Fracture; and E10.02, Behavior and Use of Nuclear Materials.



David Darwin, PhD, PE, is the Deane E. Ackers Distinguished Professor and chair of the Department of Civil, Environmental, and Architectural Engineering at the University of Kansas. He is a member of ASTM Committees A01, Steel, Stainless

Steel and Related Alloys, and G01, Corrosion of Metals. His research interests include anchorage and development of reinforcing steel, minimizing cracking in concrete structures, and corrosion of reinforcing steel.



Ashwin Poudel is a project consultant at Simpson Gumpertz & Heger Inc. PC in New York, NY. His interests include structural design, repair, rehabilitation, investigation, and condition assessment of buildings and structures of various types.

## Abstract

An interlaboratory study involving 19 laboratories was conducted to quantify the precision of ASTM A1061-16, *Standard Test Methods for Testing Multi-Wire Steel Prestressing Strand*, which describes methods for measuring yield strength, elastic modulus, elongation, breaking strength, and relaxation. Relaxation measurements were outside the project scope. Yield strength, elastic modulus, and breaking strength results showed low variability, with reproducibility limits less than 4%, 10%, and 3% of the mean reported values, respectively. Elongation results exhibited high variability, resulting in a reproducibility limit close to 50% of the mean reported value. Compliance with the requirements of the standard was an issue, with 74%, 82%, 32%, and 100% of laboratories submitting valid results for yield strength, elastic modulus, elongation, and breaking strength, respectively. Strand fracture location was sensitive to the type of grips used for testing. Several changes to ASTM A1061 are proposed to improve clarity and precision.

## Keywords

ASTM A1061/A1061M, breaking strength, elastic modulus, elongation, precision, strand, yield strength.

## Review policy

This paper was reviewed in accordance with the Precast/Prestressed Concrete Institute's peer-review process.

## Reader comments

Please address any reader comments to *PCI Journal* editor-in-chief Tom Klemens at [tklemens@pci.org](mailto:tklemens@pci.org) or Precast/Prestressed Concrete Institute, c/o *PCI Journal*, 8770 W. Bryn Mawr Ave., Suite 1150, Chicago, IL 60631. 