

Entomological Contributions in Memory of Byron A. Alexander

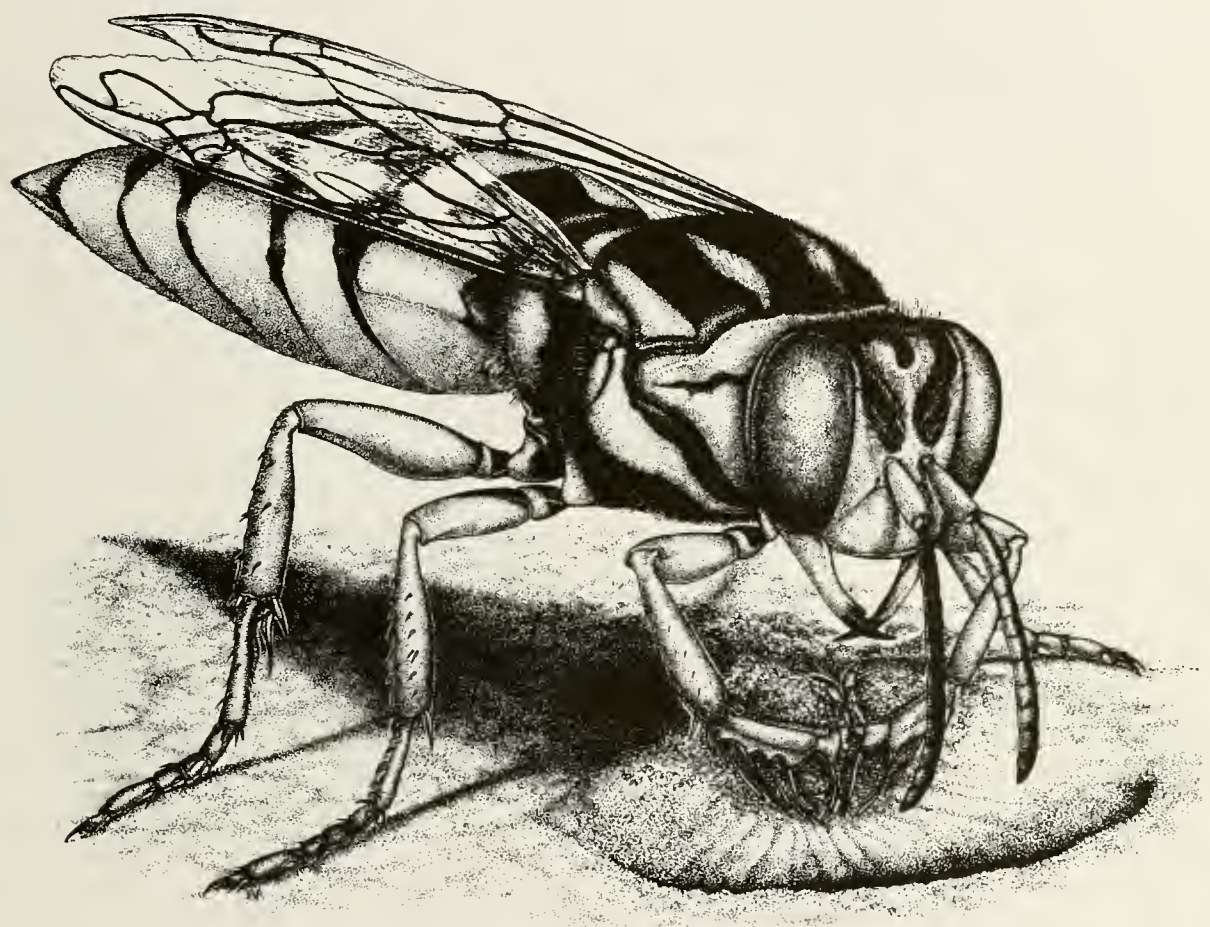

Edited by
George W. Byers, Robert H. Hagen,
and Robert W. Brooks

DL
1663
ESY
1999

The University
Museum of Comparative Zoology
Harvard University

PUBLICATIONS OF THE NATURAL HISTORY MUSEUM, THE UNIVERSITY OF KANSAS

The University of Kansas Publications, Museum of Natural History, beginning with Volume 1 in 1946, was discontinued with Volume 20 in 1971. Shorter research papers formerly published in the above series were published as The University of Kansas Natural History Museum Occasional Papers until Number 180 in December 1996. The Miscellaneous Publications of The University of Kansas Natural History Museum began with Number 1 in 1946 and ended with Number 68 in February 1996. Monographs of The University of Kansas Natural History Museum were initiated in 1970 and discontinued with Number 8 in 1992. The University of Kansas Science Bulletin, beginning with Volume 1 in 1902, was discontinued with Volume 55 in 1996. The foregoing publications are now combined in a new series entitled Scientific Papers, Natural History Museum, The University of Kansas, begun with Number 1 in 1997. Special Publications began in 1976 and continue as an outlet for longer contributions and are available by purchase only. All manuscripts are subject to critical review by intra- and extramural specialists; final acceptance is at the discretion of the editor.

The publication is printed on acid-free paper. Publications are composed using Microsoft Word® and Adobe PageMaker® on a Macintosh computer and are printed by The University of Kansas Printing Services.

Institutional libraries interested in exchanging publications may obtain the Scientific papers, Natural History Museum, The University of Kansas, by addressing the Exchange Librarian, The University of Kansas Libraries, Lawrence, Kansas 66045-2800, USA. Available back issues of The University of Kansas Science Bulletin may be purchased from the Library Sales Section, Retrieval Services Department, The University of Kansas Libraries, Lawrence, Kansas 66045-2800, USA. Available issues of former publication series, Scientific Papers, and Special Publications of the Natural History Museum can be purchased from the Office of Publications, Natural History Museum, The University of Kansas, Lawrence, Kansas 66045-2454, USA. Purchasing information can be obtained by calling (785) 864-4450, fax (785) 864-5335, or e-mail (kunhm@ukans.edu). VISA and MasterCard accepted; include expiration date.

SERIES EDITOR: William E. Duellman

PRINTED BY
THE UNIVERSITY OF KANSAS PRINTING SERVICES
LAWRENCE, KANSAS

THE UNIVERSITY OF KANSAS
NATURAL HISTORY MUSEUM

SPECIAL PUBLICATION NO. 24

17 DECEMBER 1999

Entomological Contributions in Memory of Byron A. Alexander

Edited by

GEORGE W. BYERS

*Professor Emeritus, Snow Entomological Collection,
Division of Entomology, Natural History Museum and
Biodiversity Research Center, The University of Kansas,
Lawrence, Kansas, 66045, USA*

ROBERT H. HAGEN

*Adjunct Assistant Professor, Department of Entomology,
The University of Kansas, Lawrence, Kansas, 66045, USA*

AND

ROBERT W. BROOKS

*Collection Manager, Snow Entomological Collection,
Division of Entomology, Natural History Museum and
Biodiversity Research Center, The University of Kansas,
Lawrence, Kansas, 66045, USA*

NATURAL HISTORY MUSEUM
THE UNIVERSITY OF KANSAS
LAWRENCE, KANSAS

82
125
E 97
1202

SPECIAL PUBLICATIONS
NATURAL HISTORY MUSEUM, THE UNIVERSITY OF KANSAS

SERIES EDITOR: William E. Duellman

MCZ
LIBRARY

FEB 16 2000

HARVARD
UNIVERSITY

SPECIAL PUBLICATION No. 24
pp. i-iv, 1-252
Published 10 December 1999
ISBN 0-89338-057-1

© 1999 BY NATURAL HISTORY MUSEUM
DYCHE HALL
THE UNIVERSITY OF KANSAS
LAWRENCE, KANSAS 66045-2454 USA

PRINTED BY
UNIVERSITY OF KANSAS PRINTING SERVICE
LAWRENCE, KANSAS

CONTENTS

INTRODUCTION <i>George W. Byers, Robert H. Hagen, and Clare T. Wuellner</i>	1
THE AUGOCHLORINE BEE GENUS <i>MEGALOPTILLA</i> (HYMENOPTERA: HALICTIDAE) <i>Michael S. Engel and Robert W. Brooks</i>	9
REDESCRIPTION OF <i>LINSLEYONIDES SKILES</i> (COLEOPTERA: CERAMBYCIDAE) AND INCLUSION OF <i>ELAPHIDION PORTORICENSIS</i> FISHER <i>Steven W. Lingafelter</i>	17
<i>ANTHIDIUM OBLONGATUM</i> (ILLIGER): AN OLD WORLD BEE (HYMENOPTERA: MEGACHILIDAE) NEW TO NORTH AMERICA, AND NEW NORTH AMERICAN RECORDS FOR ANOTHER ADVENTIVE SPECIES, <i>A. MANICATUM</i> (L.) <i>E. Richard Hoebeke and A. G. Wheeler, Jr.</i>	21
DISTRIBUTION AND ETHOLOGY OF <i>CERAMIUS DAMARINUS</i> TURNER (HYMENOPTERA: VESPIDAE: MASARINAE) IN NAMIBIA <i>Sarah K. Gess</i>	25
THE ULTRASTRUCTURE OF THE WALL AND LINING EPITHELIUM OF GLANDULAR POUCHES IN NOMADINE BEES (HYMENOPTERA: APIDAE: NOMADINAE) <i>Bruce Cutler and Byron A. Alexander</i>	33
MATING BEHAVIOR OF <i>DIANTHIDIUM CURVATUM</i> (HYMENOPTERA: MEGACHILIDAE) AT A NEST AGGREGATION <i>Gail R. Michener and Charles D. Michener</i>	37
BEHAVIOR AND SUBCASTE SPECIALIZATION AMONG WORKERS OF THE GIANT TROPICAL ANT, <i>PARAPONERA CLAVATA</i> (HYMENOPTERA: FORMICIDAE: PONERINAE) <i>Rodney S. Hanley and James P. Lovett</i>	45
THE FEMALE OF <i>DIADASIA AFFLICTULA</i> COCKERELL UNVEILED AND VERIFIED USING MOLECULAR MARKERS (HYMENOPTERA: APIDAE) <i>Sedonia D. Sipes</i>	51
NESTING BIOLOGY AND IMMATURE STAGES OF THE SOUTH AMERICAN BEE GENUS <i>ACAMPTOPOEUM</i> (HYMENOPTERA: ANDRENIDAE: PANURGINAE) <i>Jerome G. Rozen, Jr. and D. Yanega</i>	59
AN INVENTORY OF ARTHROPOD FAUNA AT GREAT SAND DUNES NATIONAL MONUMENT, COLORADO <i>Michael J. Weissmann and Boris C. Kondratieff</i>	69
THE DISTRIBUTION OF <i>HALICTUS LIGATUS</i> SAY AND <i>H. POEYI</i> LEP. (HYMENOPTERA: HALICTIDAE) IN NORTH AMERICA <i>Laurence Packer</i>	81
ORIGINS OF SYMBIOSIS: PHYLOGENETIC PATTERNS OF SOCIAL INSECT INQUILINISM IN CRYPTOPHAGIDAE (COLEOPTERA: CUCUJOIDEA) <i>Richard A. B. Leschen</i>	85
TIMING OF MATING FLIGHTS OF NEOTROPICAL AFRICAN AND EUROPEAN HONEY BEE QUEENS AND DRONES (HYMENOPTERA: APIDAE) IN EASTERN VENEZUELA <i>Gard W. Otis, Orley R. Taylor, Jr., Marla Spivak, Mark L. Winston, Susan J. Katz, and Penelope F. Kukuk</i>	103
<i>EICKWORTIA</i> (APOIDEA: HALICTIDAE), A NEW GENUS OF BEES FROM MESOAMERICA <i>Ronald J. McGinley</i>	111
A NEW <i>BITTACUS</i> FROM SOUTHERN MEXICO (MECOPTERA) <i>George W. Byers</i>	121
RESOLVING CONFLICT BETWEEN MORPHOLOGICAL AND MOLECULAR EVIDENCE FOR THE ORIGIN OF EUSOCIALITY IN THE "CORBICULATE" BEES: A HYPOTHESIS-TESTING APPROACH <i>Ted R. Schultz, Michael S. Engel, and Michael Prentice</i>	125
UNA ESPECIE NUEVA DE <i>SMERINGODYNERUS</i> (HYMENOPTERA: VESPIDAE: EUMENINAE) DE MÉXICO <i>Alicia Rodríguez-Palafox</i>	139

BEHAVIOR OF A CLEPTOPARASITIC BEE, <i>TRIEPEOLUS DISTINCTUS</i> (HYMENOPTERA: NOMADINAE), BEFORE DEPARTING FROM THE NEST OF ITS HOST, <i>DIEUNOMIA TRIANGULIFERA</i> (HYMENOPTERA: HALICTIDAE) <i>Clare T. Wuellner and Mark S. Hixon</i>	143
DESCRIPTION OF PREIMAGINAL INSTARS OF FOUR SPECIES OF ELAMPINI, WITH SOME NOTES ON THE PHYLOGENETIC IMPORTANCE OF LARVAL CHARACTERS IN THIS TRIBE (HYMENOPTERA: CHRYSIDIDAE) <i>José Tormos, Karl V. Krombein, Josep D. Asís, and Severiano F. Gayubo</i>	151
LOCAL ACOUSTICS VERSUS HOST PLANT RESOURCES: DETERMINANTS OF CALLING SITES IN A TROPICAL KATYDID, <i>OROPHUS CONSPERSUS</i> (ORTHOPTERA: TETTIGONIIDAE) <i>Sara L. Taliaferro, Danel Vickerman, Michael D. Greenfield</i>	157
REVISION OF THE SPECIES OF THE SUBGENERA OF <i>EXOMALOPSIS</i> SPINOLA, 1853, OCCURRING IN SOUTH AMERICA. I: <i>DIOMALOPSIS</i> MICHENER & MOURE, 1957 (HYMENOPTERA: APIDAE), AND A REVISED KEY TO THE SUBGENERA <i>Eduardo A. B. Almeida and Fernando A. Silveira</i>	167
NEW SPECIES, PHYLOGENETIC PLACEMENT, AND MAMMAL ASSOCIATIONS OF <i>LOBEROPSYLLUS</i> (LANGURIIDAE: XENOSCELINAE) <i>Richard A. B. Leschen and James S. Ashe</i>	171
FLOATING AND NEST ADOPTION IN A NESTING AGGREGATION OF THE MEXICAN OPUNTIA BEE <i>DIADASIA KNABIANA</i> (APIDAE) <i>Rudolf Jander</i>	179
NOVEL USE OF WALKING TRAILS BY THE AMAZONIAN BUMBLE BEE, <i>BOMBUS TRANSVERSALIS</i> (HYMENOPTERA: APIDAE) <i>Sydney A. Cameron, James B. Whitfield, Miles Cohen, and Natalie Thorp</i>	187
INFLUENCE OF THREE FACTORS ON AFRICAN HONEY BEE SWARMS' PREFERENCE FOR BAIT HIVES IN MEXICO <i>Carlos H. Vergara</i>	195
POPULATION GENETICS OF THE GREATER WAX MOTH, <i>GALLERIA MELLONELLA</i> L. (LEPIDOPTERA: PYRALIDAE) <i>Amy M. McMillan</i>	201
A NEW SPECIES OF <i>DIADASIOPUS</i> (ACARI: ACARIDAE) ASSOCIATED WITH <i>DIADASIA CHILIENSIS</i> (HYMENOPTERA: APIDAE) IN CHILE <i>Barry M. OConnor and Gerald Daneshvar</i>	207
LIFE ON THE EDGE: OBJECT ORIENTATION AND AQUATIC LOCOMOTION IN <i>PAEDERUS ARDUUS</i> SHARP (COLEOPTERA: STAPHYLINIDAE) <i>Sandra Haase-Statz and Elizabeth F. Smith</i>	211
<i>ODYNEROPSIS</i> , A GENUS NEW TO THE UNITED STATES, WITH DESCRIPTIONS OF OTHER NEW CLEPTOPARASITIC APIDAE (HYMENOPTERA: APOIDEA) <i>Terry Griswold and Frank D. Parker</i>	217
TWO NEW GENERA OF PEMPHREDONINE WASPS FROM AUSTRALIA (HYMENOPTERA: APOIDEA, CRABRONIDAE) <i>Gabriel A. R. Melo and Ian Naumann</i>	221
REASSESSMENT OF THE BEE GENUS <i>CHAETURGINUS</i> (APOIDEA: ANDRENIDAE, PANURGINAE), WITH THE DESCRIPTION OF A NEW SPECIES FROM SOUTHEASTERN BRAZIL <i>Luisa Ruz and Gabriel A. R. Melo</i>	231
PROLEGS OF PAPILIONINI (LEPIDOPTERA: PAPILIONIDAE): ALTERNATIVE SOLUTIONS TO THE PROBLEM OF ATTACHMENT <i>Robert H. Hagen</i>	237

Byron A. Alexander (1952–1996)

By

GEORGE W. BYERS¹, ROBERT H. HAGEN², AND CLARE T. WUELLNER³

BIOGRAPHY

This collection of entomological contributions resulted from a feeling among his friends and colleagues that Byron Alexander deserved more than a memorial service and an obituary, following his tragically premature death on 30 November 1996. A biologist with broad interests and experiences, Byron had earned the friendship and respect of associates in a variety of fields and from institutions around the world, as indicated by the papers that make up this volume. Despite his many interests, Byron had worked mainly on the systematics, behavior, and morphology of bees and sphecid wasps. The published results of his research are listed at the end of this introduction. Reading this list, one is impressed by the amount of scholarly productivity in Byron's short professional career.

Byron was an outstanding teacher, popular among his students not only for his knowledge of his subjects but also for his enthusiasm and his sense of humor. His courses at the University of Kansas included insect classification, external morphology of insects, social insects and introductory systematics. He also had taught two undergraduate biology courses and a summer field course in entomology; and he had helped teach two short courses at other institutions, one in Mexico, at the Centro de Ecología, Hermosillo, the other in Honolulu, sponsored by the University of Hawaii and the Bernice P. Bishop Museum. While a graduate student at Cornell University, he received an award for outstanding teaching. The amount of his teaching is the more remarkable because in addition to his appointments in the departments of Entomology and of Systematics and Ecology, Byron held a half-time curatorial position in the Snow Entomological Museum.

Byron was an exceptionally gifted artist and was able to apply this talent to some of his publications, such as the "Comparative Morphology of the Female Reproductive System of Nomadine Bees" (Memoirs of the Entomological Society of Washington, 1996). During the summers in which he was employed by the National Park Service, Byron illustrated several brochures on wildlife in various parks. In 1984, he exhibited some of his drawings at a national meeting of the Guild of Natural Science Illustrators,

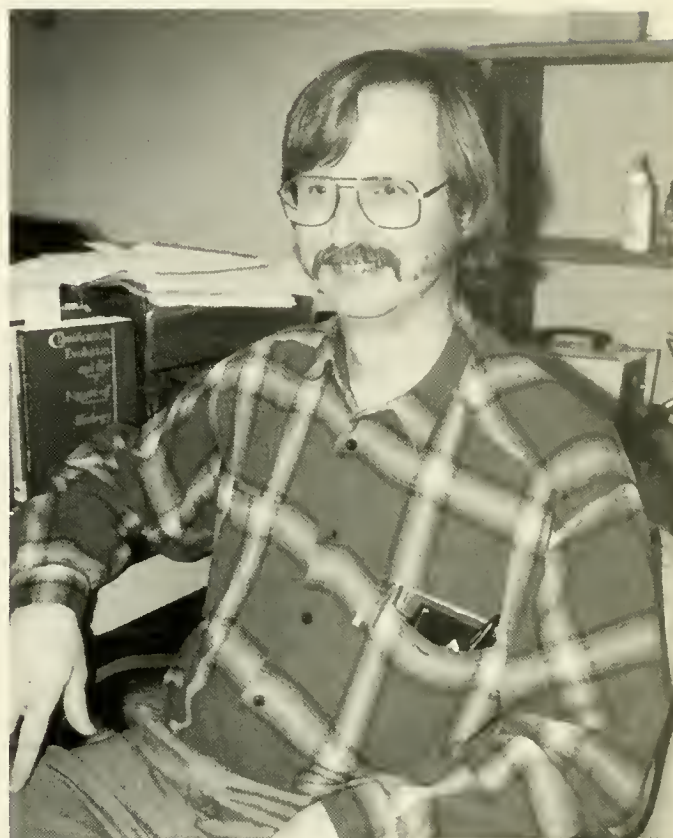

and four years later he again displayed drawings, this time for the Eastern Branch of the Entomological Society of America. He also illustrated a book on "The Natural History and Behavior of North American Beewolves" (*Philanthus* wasps), by Howard Evans and Kevin O'Neill (1988; Fig. 1). His drawing of a sphecid wasp, *Glenostictia pictifrons*, appears on the cover of this volume, and has been used on a recruitment poster by the Department of Entomology at the University of Kansas.

Byron Allen Alexander was born in Austin, Texas, on 14 April 1952, one of three sons of Harold and Betty Alexander. (In an earlier obituary [Journal of Hymenoptera Research, 6: 186-189, 1997], his birthplace was incorrectly reported as El Paso.) The family moved to El Paso, where Byron later attended the University of Texas at El Paso,

¹ Snow Entomological Collection, Division of Entomology, Natural History Museum, University of Kansas, Lawrence, Kansas 66045.

² Department of Entomology, University of Kansas, Lawrence, Kansas 66045.

³ Department of Zoology, University of Texas, Austin, Texas 78712.

graduating with highest honors in 1974. Interested in animal behavior, Byron entered a graduate program in primatology at Stanford University, intending to work with Jane Goodall in Tanzania. However, in May, 1975, the research station at Gombe Reserve was attacked by rebels who kidnapped two American students. The field research program in primatology was terminated in response, and Byron left Stanford at the end of 1975. The next year he was able to join a Scottish research group studying chimpanzees in Senegal. After only 6 months, however, he became ill with hepatitis and had to return to the United States. Briefly in 1976, and again in 1978–1981, he was a seasonal park naturalist at Capitol Reef National Park in Utah, Great Sand Dunes National Monument in Colorado, and Tuzigoot National Monument in Arizona. While working in the Great Sand Dunes, Byron became interested in entomology, particularly in the behavior of wasps, after meeting students of Prof. Howard Evans of Colorado State University. Byron enrolled at Colorado State to work with Evans and, in 1983, earned the M.S. degree there. He then entered Cornell University, where he studied behavior and systematics of Hymenoptera under Prof. George Eickwort. While at Cornell, Byron was awarded a National Science Foundation Graduate Fellowship, the John Henry Comstock Scholarship, and three other fellowships. He received the Ph.D. degree in 1989 and in the summer of that year joined the Department of Entomology at the University of Kansas as an assistant professor. In 1995, he was promoted to associate professor with tenure.

During his professional career, Byron was a member of the Entomological Society of America (associate editor of the *Thomas Say Publications in Entomology*, 1994–1996), the International Society of Hymenopterists, the Animal Behavior Society, the International Union for the Study of Social Insects, the Central States Entomological Society (president in 1995–1996; member of the editorial board of the *Journal of the Kansas [Central States] Entomological Society*, 1994–1996), the Society of Systematic Biology, the American Association for the Advancement of Science, and the Sigma Xi Scientific Research Society.

George W. Byers

BYRON AS NATURALIST AND SCIENTIST

While still a student at the University of Texas at El Paso (UTEP), Byron met Art Metcalf, a professor in the Biology Department. They began a lifelong friendship, maintained through visits and correspondence. After Byron's death, Prof. Metcalf organized and transcribed the letters he had received from Byron over the years. The letters demonstrate Byron's skills as a keen observer of the natural and human environment, and vividly illustrate his

development as an entomologist. Excerpts from some of these letters are included below, courtesy of Prof. Metcalf.

When Byron left Stanford at the end of 1975, he was still determined to pursue field research in primatology. In the spring of 1976 he attended classes at UTEP, then took a summer job with the National Park Service while he considered his alternatives:

(22 June 1976) ... I am presently working as a seasonal naturalist at Capitol Reef National Park [Utah], answering questions at the Visitor Center, leading conducted hikes, and giving evening programs. ... This park is relatively remote and obscure, so we don't have too many visitors very often, and the days of bad craziness are rare. However, one Memorial Day weekend was enough to persuade me that I wouldn't want to make a permanent career of working for the Park Service. One could get transferred to Yosemite.

Nevertheless, there are abundant compensations to outweigh the tribulations of this job. This is without doubt the most beautiful place I have ever lived in. Just beyond my back fence is a delightful little creek patrolled by swallows and lined with a few magnificently gnarled and twisted, patriarchal cottonwoods. For a backdrop, there is a 900 foot wall of Wingate Sandstone.

Everywhere the landscape is dominated by rock: awesome, immense, intricately sculptured and textured, brilliantly colored. An ideal place to regain, or lose, your sanity. Right now I am sitting amidst a forest of pinyon and juniper on Cedar Mesa, where the wind always blows. The sun is almost gone, its last rays lighting the top of Tarantula Mesa, gilding the strangely eroded forms of the Mancos Shale. Surely this is a good place to be, and at least for now past, present, and future are woven together in a single tapestry of timelessness.

Byron arranged to join a research group based at St. Andrews University in Scotland that was studying chimpanzees in West Africa. He was able to pay for his passage across the Atlantic by working as a scientific illustrator for a UTEP herpetologist, and arrived at the field site in Senegal in the spring of 1977:

(8 May 1977) The country around our camp at Mt. Assirik [Senegal] is very dry now, right at the end of the 7-month dry season. If this were the Southwest, Mt. Assirik would undoubtedly be called a mesa. Its slopes are covered in woodland composed largely of Caesalpiniaceae (*Azelia africana*, *Erythrophleum suaveolens*) and Mimosaceae (*Parkia biglobosa*), with an occasional baobab or rhum palm. The streams draining Mt. Assirik soon encounter a layer of very hard, resistant rock (all rock around here, as well as dust, soil, or anything else to do with the earth, is called laterite), which forces them to cut steep, narrow gorges separated by broad stretches of flat land locally known as plateaux. The contrast between the vegetation of the gorges and that of the plateaux is one of the most abrupt and striking I have ever seen. At this time of the year, the plateaux are almost completely barren, with only scattered stands of a shrubby tree called *Combretum* (its fruits are like 4-winged saltbush) and occasional patches of grass which were missed by the fires. On the other hand, the gorges support a dense, luxurious, jungle-like vegetation called gallery forest, for they are the only places where there is a permanent source of surface water. The gallery forest is characterized by an abundance of vines, creepers, and strangling figs, as well as tall, stately trees with enormous buttressed trunks. At least during the dry season, it is also riddled with game trails linking the few precious remaining pools of water.

So the chimps are living in an area with a wide variety of habitat types: woodland, forest, grassland, bamboo. Nevertheless, one

can't help feeling that it is marginal habitat, although that is nothing more than a subjective impression which is undoubtedly influenced by one's personal reaction to the country. It's damned hot here—last month the mean daily maximum temperature was 104 °F—and there are some annoying insects around, like sweat bees, tsetse flies, and vicious stinging bees. Consequently, one has to wear protective clothing: heavy duty long-sleeved shirts & trousers, a hat of some kind, canvas boots with gaiters. None of us is able to stay out in the field all day without being thoroughly devastated (or "knackered" as my English companions say) by the experience, so we tend to take a prolonged mid-day siesta.

(4 June 1977) ... [Tambacounda] is crowded, filthy, ugly, reeking, hot, foreign, strange, threatening. Perhaps it is because I grew up on the border or something, but poverty, squalor, and overpopulation hold no exotic charm for me. Nor does the ravaged countryside surrounding the "misty villages". Mist indeed! It's dust. Dust from the dry season, from the ceaseless pounding of hooves, from the relentless pressure of myriads of scrawny, undernourished cows, goats, sheep which immediately devour any blade of grass which is foolish, desperate, or unfortunate enough to attempt to raise its head above the parched ground. A depressingly familiar landscape, reminiscent of the country around Ojinaga [Mexico], or the Navajo reservation, or perhaps even the majority of the land surface inhabited by *Homo sapiens*.

Still, it is true that Africa does have a special enchantment about it, an intangible essence, a special vitality which my humble powers of description can never hope to evoke. Even the stench of the market place is at least ripe with the odors of life rather than stagnation. And never before have I experienced such a vibrant, pulsing, breathtaking symphony of colors. The design is bold and outlandish, without a trace of subtlety, every hue glowing with its utmost intensity, screaming reds, exploding yellows, piercing blues, exhilarating greens. My eyeballs are seared, my mind is reeling. Not at all like picking up a loaf of bread at your friendly neighborhood Safeway.

The rains have come, and their arrival was indeed dramatic. As usual, the rains are said to be unusual this year. They are unusual because they arrived suddenly, with 3 consecutive days of heavy rain totalling 110 mm. Those were awesome storms, quite reminiscent of a summer cloudburst in West Texas (or Kansas?). The change they wrought was abrupt and complete. Suddenly the air is clear and fresh, and all the subdued and dusty hues of the dry season have been washed away to reveal the inner fire of True Color which burns within all things. Already the plateaux are showing a faint flush of green, exquisite white lilies are erupting from bare rock, shrubs are exploding into leaf or flower, termites are swarming suicidally in mindless, milling hordes, the tsetses are emboldened, the chimps have vanished without a trace. Life is asserting itself; the strange and improbable combinations of protons and electrons are whirling feverishly in their frenzied, intricate, beautiful, irresistible dance. I can't help joining in, although I have no idea what it's all about.

Byron returned to the U. S. in October 1977. Having experienced first hand the difficulty of field research on great apes, he decided not to pursue an academic career in primatology. However, he still hoped to return to West Africa, and applied for a position with the Peace Corps. While he waited, Byron supported himself by seasonal work with the Park Service and by freelance illustration jobs (Fig. 2). A chance encounter at Great Sand Dunes National Monument set him on the path towards entomology:

(27 Sept 1978) An unexpected delight of the summer was meeting Darryl Gwynne, a British-born immigrant from Canada who is doing graduate work at Colorado State. The subject of Darryl's



Fig. 1. Territorial defense by *Philanthus bicinctus* males, Great Sand Dunes National Monument. Byron used this as part of a composite illustration for *The Natural History and Behavior of North American Beevolves*. (Howard E. Evans and Kevin M. O'Neill, Cornell University Press, Ithaca, NY, 1988.)

studies is *Philanthus bicinctus*, a congener of Tinbergen's European bee wolf. Darryl's enthusiasm for his wasps is infectious, and they are intriguing, if somewhat macabre, creatures. From a primatologist's perspective, there are also other attractive aspects of wasp research. Bumblebee wolves (as Darryl has christened his wasps) don't generally become active until around 9:00 a.m., and generally knock off in mid-afternoon. A generation only lasts about 6-8 weeks anyway. But those few short weeks are a time of intense activity for a multitude of individuals (enough to satisfy the most unyielding statistical demands). I doubt that I would have been able to discern much order in the frenzy of a *P. bicinctus* nesting area, but with the tutoring of Darryl's trained eye (this was his third year of observations) I was able to learn something of the bizarre life of Bumblebee Wolf Arroyo. The most conspicuous activity in the nesting area was the territorial behavior of the males, who display an insane singleness of purpose in defending areas around female burrows. They will attack a pebble if you toss one through their territory (a handy trait if one wishes to census territorial males). Nor do they hesitate to approach such predators as robber flies, which makes them ridiculously vulnerable to predation. But I suppose there is a limit to how many wasps a robber fly can suck dry before it becomes too bloated to fly.

... *P. bicinctus* is only one of many species of solitary wasps which thrive in the rich mosaic of sandy substrates here. Darryl's advisor is Howard Evans, who has gained some notoriety with his lifetime of work on the comparative ethology of various solitary wasps. He made a couple of visits to Great Sand Dunes this summer, and learned some interesting things. Just up the arroyo from Darryl's *P. bicinctus* nesting area is an aggregation of *P. zebratus* burrows. In excavating one of these *P. zebratus* burrows, Evans found that the cells had been provisioned with males of *P. bicinctus* and *P. zebratus*. So he suggested that *P. zebratus* be christened the bumblebee wolf wolf (or even the bumblebee wolf wolf wolf.). Another interesting observation of *P. zebratus* this summer was the discovery of 2 males simultaneously in copula with a single female. I can just imagine their respective sperm cells violently flagellating away at one another in a heated race to the ovum (or would it be ova? My knowledge of basic insect biology is still very shaky.)

Eventually, tired of waiting for the Peace Corps to act on his application, Byron turned toward other goals and decided to pursue graduate study in insect behavior:

(29 January 1981) I've just returned from a trip to Colorado State and the University of Colorado. Both have good behavior programs and both are encouraging about my chances of being accepted as a graduate student, despite my somewhat erratic past....

I sat in on one day of a conference of the Entomological Society of America just after Thanksgiving. There was supposed to be a symposium on the sociobiology of the social insects, but the main event seemed to be getting drunk at the hospitality suites provided by the chemical companies that manufacture pesticides. I also had my very first meal at a Japanese restaurant. Across the table, John Alcock, Randy Thornhill, and somebody from Utah State were scribbling mathematical models on a napkin and having an animated discussion about confidence of paternity being irrelevant to male paternal investment. Counter-intuitive stuff, quite risqué intellectually. I learned that chicken teriyaki is very tasty.

(6 April 1981) ... I have decided to accept a T.A. that was offered to me by Colorado State. I think there are still some papers I have to sign to make it all official, but I have the impression that this is just routine procedure; and it's already too late to change my mind. Not that I'm feeling any inclination to do so, but there is a certain finality about signing documents.

I'm going to be working under Howard Evans. I have 2 possible research projects in mind: either a study of the nesting behavior of *Clypeadon*, a digger wasp which preys on harvester ants and isn't as common as one might expect for a wasp whose prey is so abundant; or a study of how parasitic miltogrammine flies recognize potential hosts, and how those hosts avoid their parasites. The former is more specific and straightforward, and therefore probably a better place for me to start. As it turns out, Howard suspects that miltogrammine flies are responsible for the relative scarcity of *Clypeadon*, so the 2 problems are not unrelated. No doubt one could spend an entire lifetime studying the intricacies of the relationships of miltogrammine flies and sphecid wasps—but I'm not quite ready to make such a commitment myself. Fortunately, nobody has drawn up any contracts for me to sign.

Byron completed his Master's thesis in the spring of 1983 (Alexander, 1985, 1986), then moved to Cornell University to begin his Ph. D. work under George Eickwort:

(12 March 1983) ... Fort Collins has been having a very mild winter, and now it appears to be over. Grass is greening up all over town, trees are scattering pollen, green blades of daffodils and irises are rising, flickers are drumming, robins are trying out their familiar phrases, Canada geese are chasing each other across the pond down the road, honeybee workers are taking brief scouting trips, and the harvester ants are back at work on their mounds. It's difficult to concentrate on my thesis, but with an April 8 deadline I haven't much time for Spring Fever. I have at last received written comments from all my committee members, so I can spend Spring Break working on the final draft. If all goes well this week, perhaps I can allow myself a weekend trip to Great Sand Dunes. Then again, perhaps it will snow. I try to remind myself from time to time that this is Colorado.

Next year I'll have to learn the vagaries of the climate of New York's Finger Lakes district. Cornell offered me a fellowship, which I was happy to accept. I hope they won't change their minds when I get there and it becomes evident that I'm not very Ivy-Leagueish (in fact, I'm not even sure how to spell it). On Monday evening I'll be going to my advisor's house to see some slides and find out what I'm getting into. I have visions of warblers in Sapsucker Woods, but I suppose there will be more to it than that. The man who has agreed to be my advisor, George Eickwort, works on the

behavior and systematics of bees and mites, although he has a few students working on wasps and social spiders.

(5 January 1984) ... I have been pleasantly surprised by how much I am enjoying Cornell. I'm devoting a lot of time and energy to filling in the substantial gaps in my understanding of basic insect biology (i.e. morphology, physiology, systematics, ecology), since there are good courses dealing with all these topics. At the same time, there is an entire department of Neurobiology and Behavior, with people working on birds, mammals, fish, and even spiders. There is one graduate student studying grooming behavior in yellow baboons at Amboseli. So I have plenty of opportunity to keep in touch with ideas and observations in the field of behavior. The entomology department has an active group of people interested in systematics. I never encountered anything like this at Stanford or CSU (Howard Evans kept his taxonomy to himself). Consequently, I was quite baffled by Jim Carpenter, who was finishing up his Ph.D. just as I arrived here, and who generously put me up in his house while I looked for a place to live. He wore T-shirts sporting such esoteric but obviously outrageous slogans as: "Cladistics-it's the real thing" and "Crush paraphyly under the iron heel of true science."

(30 November 1985) I had my first brief personal exposure to the mysteries of island biogeography in May. Cornell University sent a small-scale collecting expedition to Puerto Rico. I was able to tag along as a field assistant on my major professor's grant, since classes were still in session, so that the undergraduate assistant he had hired for the summer wasn't yet available to work for him. Three members of our expedition were coleopterists so they spent their days breaking open logs and turning over rocks in the rain-drenched, mossy, pristine forests of the Central Highlands. However, I was on the sweat bee team. We found the best nesting sites to be on Puerto Rico's public beaches (the name they used for these beaches was "baineario"). We were never arrested, or even questioned by the police, but I don't think our unusual behavior went unnoticed. For our part, we kept remarking that island faunas really are depauperate. It is easier to find sweat bees on a spring day in Ithaca than in Puerto Rico. The landscape looked and felt unmistakably tropical, but the much-vaunted diversity of the tropics was not there. The plants and animals we saw looked tropical—bamboo, tree ferns, cecropia, flame trees, bananaquits, todies (not many of these), grackles, frigate birds, and the ubiquitous little treefrogs (called "coqui", which is a fair description of what they sound like). But there were lots of Neotropical things which were not on the islands—no monkeys, or motmots, or toucans, or armadillos, or stingless bees, or army ants or euglossine bees—the list could go on and on. I realize that this isn't any surprise to a sophisticated biogeographer, but it's almost eerie to actually experience it. It's enough to make one believe in empty ecological niches.

I've spent the summer and fall beginning to get acquainted with *Nomada*, the genus of bees whose phylogeny I'm trying to unravel. No doubt I would be more efficient if I knew what I was doing, but if I knew that would I be here? I was curious about whether a cleptoparasitic way of life would result in modifications of the female reproductive tract, so I began dissecting bees this summer. I found some unexpected and unexplained structures—a pair of thin-walled sacs at the base of the reproductive tract. Whatever they're for, they seem to be present in all the members of the subfamily Nomadinae, and absent from other bees. I also diverted myself with trying to devise a technique for illustrating these structures in a way that would show how very nearly transparent they are.

Byron completed his Ph. D. dissertation in 1989 and moved to Kansas as an assistant professor in the Department of Entomology:

(19 September 1989) Although my life has taken many strange turns, this is surely one of the strangest. I find myself on the fac-

ulty of the University of Kansas, in a tenure track position that is a joint appointment with the Snow Entomological Museum, the Entomology Dept. and the Systematics & Ecology Dept. Needless to say, I'm delighted to be here. After all, they do have an excellent bee collection, which is not the sort of thing that universities routinely support. I also find Lawrence to be a very pleasant place to live. Far nicer than, say, Chicago or Philadelphia where two other openings for an insect systematist were advertised this year. So I've been extraordinarily lucky. I had to really push to finish my thesis in time to start here for the fall semester, but at least it's over now and I won't ever have to do that again. Of course, it's out of the frying pan and into the fire, but I should be old enough to expect that by now.

(9 October 1989) Yesterday was a glorious, sun-drenched golden autumn afternoon, so I made my first trip out to the Flint Hills. Lost somewhere in the fading memory of my fast-receding youth is some mysterious influence that kindled in me a special enchantment with the prairie. And somehow the Flint Hills came to represent the essence of the prairie, much as the view across the Snake River towards the Grand Tetons is the essence of the Rocky Mountains. I had never been in the Flint Hills before yesterday, yet somehow the landscape was exactly what I expected the prairie to look like, with gently undulating hills stretching out to eternity, an isolated stand of trees here and there, and a few distant cattle that could easily have been bison. And at this time of year, with the grasses taking on hues of brass and bronze and copper, the only animal sounds carried on the wind were the soft, patient, ageless songs of grasshoppers and katydids. Lots and lots of grasshoppers. I only saw one kind of bee, a tiny exomalopsine (I think) that was visiting the handful of ground-hugging, inconspicuous white asters that were still in bloom. The towering sunflowers were dark, withered stalks, and the spikelets of the great prairie grasses, big and little bluestem and Indian grass, were beginning their piecemeal disintegration and dispersal. The gentle wind tugged at my weary, overworked spirit, reviving almost forgotten visions from my childhood imagination, wild west visions of pioneers, fur traders, Pony Express riders, plains Indians, and before all of them, that strange, marvelous Pleistocene megafauna. Something about a wide-open landscape sets my spirit soaring. So I can tell I'm going to like it here.

There was a retirement celebration for Michener last spring that brought in alumni from all over the world, and the returning pilgrims all expressed amazement at how much Lawrence has grown. Nevertheless, it still isn't a large city by any means. A little larger than Ithaca, I think, but still basically a small, friendly town. When my parents were growing up in El Paso, it was about the size that Lawrence is now. It seems hard to believe doesn't it? But you've witnessed much of El Paso's cancerous expansion, so I guess you have to believe it. I hope a similar fate is not in store for Lawrence, but asne of the very most recent immigrants, I suppose I am in no position to complain about all the new people coming in (although I could point out that the last time they hired a bee systematist for the faculty here was 50 years ago). So I don't feel that bee systematists are a major threat to Lawrence's future, but perhaps that is just a self-serving post-hoc rationalization. It's much too late in the day for me to seriously ponder such profound moral issues. I need some sleep.

In a 1995 Christmas letter to friends and family, Byron described some of his research: fossil-hunting in Montana with his student, Gabriel Melo, and wasp-watching near Lawrence, Kansas, with a visiting colleague, Josep Asis (Alexander and Asis, 1997):

(22 December 1995) For me, the most enjoyable part of 1995 was the summer. The university only pays me for 9 months of the year, so I have more leeway about how I spend my summers, although it is expected that I will spend the time doing research. Because I actually enjoy doing research, I find this arrangement to be satis-

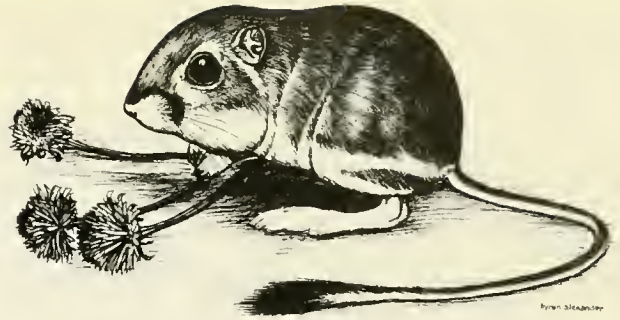

Fig. 2. Ord Kangaroo Rat, Great Sand Dunes National Monument, late 1978. From a notecard, part of a series Byron had printed from some of his drawings.

factory. My summer research activities began with a quest for fossil insects in southern Montana. This was exciting, because at present there are (as far as I know) no insect fossils of Jurassic age known from North America. (T. D. A. Cockerell described one Jurassic fossil from New Mexico, but he was so unsure about its identity that he only guessed that it might be an immature insect, and he didn't even attempt to assign it to an order. In 1968, somebody presented a talk at the Geological Society of America and reported an assemblage of aquatic bugs in Jurassic deposits in New Mexico, but apparently no descriptions of these fossils were ever published.) The leader of our expedition was a vertebrate paleontologist whose real reason for exploring these deposits was the hope of finding some bird fossils. He has observed that sites with lots of insect fossils are the kinds of places where bird fossils are eventually found if you spend enough time looking. The two entomologists on the expedition (me and a graduate student of mine from Brazil) were hoping to find interesting Hymenoptera, because the Jurassic is a time when we suspect that many important evolutionary changes were happening in the Hymenoptera. We ended up bringing home several thousand fossils, but none of them were Hymenoptera, and the overall diversity was very low. The fossils were in a marine siltstone, and most of them seemed to have been transported for some distance before settling in the sediments where they became fossils. Very few specimens had any legs or antennae, and the most common fossil was the ventral surface of an abdomen. We also found an occasional elytron. Our vertebrate paleontologist tells us that the matrix can be chemically dissolved away to reveal more detail in the fossils; so all that is needed now is the time to prepare a few thousand specimens and examine them in detail.

I was planning to spend June and early July working with a Spanish colleague on a study of a species of wasp named *Glenostictia pictifrons*, which was nesting at a site about 11 miles South of Lawrence a couple of years ago. However, we had a very rainy spring in Northeast Kansas this year, and *Glenostictia* simply never showed up. So we ended up studying a different species of solitary wasp, in the genus *Cerceris*, which we selected for the simple reason that it was there. It was the most boring wasp I have ever watched. I don't mean for this to be taken as a criticism of the wasp, because I suspect that it actually does things that are at least as interesting as what any other wasp does. However, it does not do these things where one can easily observe them. If you sit among a group of nests (which are burrows in the ground), once every 30 minutes or so you will see a wasp leave her nest, or return to her nest carrying a paralyzed beetle. The wasp leaves the nest entrance open while she is away, which means that she can very quickly enter the nest when she returns with her prey. So mostly you sit in the sun baking your brains, and this goes on all day long. Although a given individual wasp might be active for

something like 4 to 6 hours a day, within the group of nests there are early risers and late risers, so that some wasp within the aggregation is likely to be active from around sunrise until a half hour or so after sunset.

Despite the very slow pace of activity, we did learn some interesting things about these wasps; and of course there were other things to watch through the day as well. A couple of abandoned dogs befriended us, although they eventually decided we were really boring companions. At the start of the field season our study site was a wheat field; but late one evening the field was harvested, the next day it was tilled, and the next day it was planted in soybeans. I was quite impressed that wasps who had placed their nests in the wheat field were able to carry on with provisioning in spite of the Armageddon-like alterations of the world around them.

Finally, a note on his Christmas card to Art Metcalf:

(December, 1995) I realized how much my world view has come to be dominated by mellicentrism when I caught myself wondering who pollinated the flowers that produced the berries that formed the centerpiece of your Christmas card. This is not to say that I have lost my appreciation for the berries themselves, as objects pleasing to both the eye and the tongue. But I do wonder if the blossoms were visited just by honey bees, or by some spring *Andrenas*, or bumble bees, or halictids, or perhaps even flies or butterflies. Part of a mature understanding of the ways of bees is the realization that many of them are opportunistic thieves who simply consume pollen and/or nectar without providing any effective transfer of pollen. On the other hand, there are flowers (especially orchids) that exploit bees in equally opportunistic and one-sided ways. *C'est la vie.*

Letters edited by Robert H. Hagen

A TEACHER, MENTOR, AND FRIEND REMEMBERED

Byron was an outstanding mentor and teacher who had a tremendous effect on the students with whom he worked. He was an exceptionally clear communicator, a master at relaying a great deal of information quickly and painlessly. Although not a dynamic speaker, he drew students in with the excitement that clearly boiled within his mind. His sense of wonder at the world around him stimulated and fostered curiosity in his students. He had the ability to present complex information in the most understandable way, showing his classes how details fit into the larger framework. He seemed to sense the best pathway of explanation for students regardless of their prior education or experience. Byron had a large personal library, and he read extensively and widely. This gave him a great breadth and depth of knowledge from which to draw for his lectures. The subjects he taught were flawlessly woven into the greater fabric of science. Nurturing the minds of students was clearly Byron's passion and forte.

Byron also taught in environments that required a less direct teaching style. He taught when he was an audience member in seminars, at informal discussions, and oral exams. He formulated questions designed to clarify a particular point for the speaker, or to lead the speaker down a pathway of thought she or he may have needed to consider. Byron had an impressive ability to use well-worded



Fig. 3. Oak, Cornell University campus (see text).

questions to allow the person to "discover" the point he thought needed to be addressed.

Byron was an artist of unusual talent. He often said with a smile that he was an artist by temperament and a scientist by training. He expressed himself artistically in pencil, charcoal, pen and ink, and acrylic paint. Often using what was at hand to render an image of what appealed to him, he once used a ballpoint pen to create a beautiful drawing of a oak tree on the Cornell campus (Fig 3). His subjects ranged from various animals to the interior of his student apartment to paintings of Texas landscapes that hang on the walls of his parents' home. His art was sometimes three-dimensional. He constructed models of insect mouthparts or legs from paper for use in the classroom. If a student had difficulty finding a particular structure by use of the microscope, Byron would quickly sketch the object being magnified and then label it in his neat lettering.

Those who knew Byron professionally have many fond memories of him. One of the great joys of being around Byron was experiencing his quick and bright wit. He enlivened any meeting, seminar, or social gathering he attended with his humor, making everyone within hearing distance laugh. Because he was so soft-spoken, if one was more than a few feet away from him, it was difficult to hear these good-natured witticisms. It was always a treat to sit close to him.

In addition to conveying information, Byron was equally adept at another important component of teaching: he was an excellent mentor. He spoke of his students with pride. He assured them in word and deed that he had great confidence in their abilities. When conversing with students, he had a knack for seeing gaps in their knowledge, and skillfully pointed students in the direc-

tion they needed to go, giving boosts when needed. He was generous to a fault with his time. Byron never hesitated to drop what he was doing to give his undivided attention to students. He never brushed off a student; his answers were always thoughtful and complete, usually leading to extended conversation about the topic at hand.

His mentor, the late George Eickwort, commented that Byron was unique in his ability to communicate. Byron could talk to anyone with ease, no matter what the person's age, position in life, education, or demeanor. He never spoke down (or up) to anyone. All who knew Byron knew him to be exceptionally humble and self-deprecating. Bright and talented as Byron was, he never made a comment that would belittle someone, though he surely could

have. When he thought highly of someone, he would describe him or her as a "fine person." This being the scale that had meaning for him, I would have to say that Byron was the finest person I have ever known.

Most important to me, Byron has influenced profoundly the way I interact with students. I always have been conscious of Byron's wisdom and influence, but following his death I became aware of a cornucopia of lessons Byron had taught me indirectly. He was (and continues to be for me) an amazing teacher and mentor. Those of us who knew and admired him sincerely hope we can successfully pass to others the gift he gave so freely to us. It was truly a joy to be his student.

Clare T. Wuellner

Scientific Publications of Byron A. Alexander

- Kramer, H. D., B. A. Alexander, C. Clark, C. Busse and D. C. Riss. 1977. Empirical choice of sampling procedure for optimal research design in the longitudinal study of primate behavior. *Primates* 18: 825-835.
- Alexander, B. A. 1985. Predator-prey interactions between the digger wasp *Clypeadon laticinctus* and the harvester ant *Pogonomyrmex occidentalis*. *Journal of Natural History* 19: 1139-1154.
- Alexander, B. A. 1986. Alternative methods of nest provisioning in the digger wasp *Clypeadon laticinctus* (Hymenoptera: Sphecidae). *Journal of the Kansas Entomological Society* 59: 59-63.
- Henderson, C., J. Steiner and B. Alexander. 1986. *Varroa jacobsoni* life cycle. *American Bee Journal* 126: 117, 119.
- Alexander, B. A. and J. G. Rozen, Jr. 1987. Ovaries, ovarioles, and oocytes of parasitic bees. *Pan-Pacific Entomologist* 63: 155-164.
- Alexander, B. A. 1987. Eusociality and parasitism in nest-provisioning insects. Page 387 in: Eder, J. and H. Rembold (eds.), *Chemistry and Biology of Social Insects*. Verlag J. Peperny, Munich.
- Kukuk, P. F., G. C. Eickwort, M. Raveret-Richter, B. Alexander, R. Gibson, R. A. Morse and F. Ratnieks. 1989. Importance of the sting in the evolution of sociality in the Hymenoptera. *Annals of the Entomological Society of America* 82: 1-5.
- Alexander, B. A. 1990. A cladistic analysis of the nomadine bees (Hymenoptera: Apoidea). *Systematic Entomology* 15: 121-152.
- Alexander, B. A. 1990. A preliminary phylogenetic analysis of sphecid wasps and bees. *Sphecos* 20: 7-16.
- Alexander, B. A. 1991. A phylogenetic analysis of honey bees (Hymenoptera: Apidae: *Apis*). Pages 120-121 in: Veeresh, G. K., B. Mallik and C. A. Viraktamath (eds.), *Social Insects and the Environment. Proceedings of the 11th IUSSI International Congress, Bangalore, India*. Oxford and IBH Publ. Co., Pvt., Ltd.
- Alexander, B. A. 1991. *Nomada* phylogeny reconsidered (Hymenoptera: Anthophoridae). *Journal of Natural History* 25: 315-330.
- Alexander, B. A. 1991. Phylogenetic analysis of the genus *Apis* (Hymenoptera: Apidae). *Annals of the Entomological Society of America* 84: 137-149.
- Alexander, B. A. 1991. A cladistic analysis of the genus *Apis*. Pages 1-28 in: Smith, D. R. R. (ed.), *Diversity in the genus Apis*. Westview Press, Boulder.
- Alexander, B. A. 1992. A cladistic analysis of the subfamily Philanthinae (Hymenoptera: Sphecidae). *Systematic Entomology* 17: 91-108.
- Alexander, B. A. 1992. An exploratory analysis of cladistic relationships within the superfamily Apoidea, with special reference to sphecid wasps (Hymenoptera). *Journal of Hymenoptera Research* 1: 25-61.
- Alexander, B. A., D. Yanega and R. L. Minckley. 1993. Nesting biology of *Glenostictia pictifrons* (Smith) (Hymenoptera: Sphecidae: Bembicini). *Journal of the Kansas Entomological Society* 66: 108-120.
- Kazenas, V. L. and B. A. Alexander. 1993. The nest, prey and larva of *Entomosepicus kaufmani* Radoszkowski (Hymenoptera: Sphecidae). *Journal of Hymenoptera Research* 2: 221-225.
- Alexander, B. A. 1994. Species-groups and cladistic analysis of the cleptoparasitic bee genus *Nomada* (Hymenoptera: Apoidea). *University of Kansas Science Bulletin* 55: 175-238.
- Alexander, B. A. and M. Schwarz. 1994. World catalog of the cleptoparasitic bee genus *Nomada* (Hymenoptera: Apoidea). *University of Kansas Science Bulletin* 55: 239-268.
- Alexander, B. A. 1995. Description of the female of *Nomada dreisbachelorum* Moalif (Hymenoptera: Apoidea: Nomadinae). *Pan-Pacific Entomologist* 71: 130-132.
- Alexander, B. A. and C. D. Michener. 1995. Phylogenetic studies of the families of short-tongued bees (Hymenoptera: Apoidea). *University of Kansas Science Bulletin* 55: 377-424.
- Alexander, B. A. 1996. Comparative morphology of the female reproductive system of nomadine bees. *Memoirs of the Entomological Society of Washington*, no. 17, pp. 14-35.
- Alexander, B. A. and J. D. Asis. 1997. Patterns of nest occupancy and provisioning in *Cerceris rufopicta* Smith (Hymenoptera: Sphecidae). *Journal of Insect Behavior* 10: 871-893.
- Rozen, J. G., Jr., A. Roig-Alsina and B. A. Alexander. 1997. The cleptoparasitic bee genus *Rhopalolemma*, with reference to other Nomadinae (Apidae), and biology of its host *Protodufourea* (Halictidae: Rophitinae). *American Museum Novitates* No. 3194, pp. 1-28.
- Alexander, B. A., C. D. Michener, and A. L. Gardner. 1998. Dasypodidae Börner, 1919 (Insecta, Hymenoptera): proposed emendation of spelling to Dasypodaidae, so removing the homonymy with Dasypodidae Gray, 1821 (Mammalia, Xenarthra). Case 3023. *Bulletin of Zoological Nomenclature* 55: 24-28.
- Cutler, B. and B. A. Alexander. 1999. The ultrastructure of the wall and lining epithelium of glandular pouches in nomadine bees (Hymenoptera: Apidae: Nomadinae). Special Publication No. 24, Natural History Museum, The University of Kansas (this volume)

The Augochlorine Bee Genus *Megaloptilla* (Hymenoptera: Halictidae)

By

MICHAEL S. ENGEL¹ AND ROBERT W. BROOKS²

ABSTRACT The augochlorine genus-group *Megaloptilla* is given generic rank outside of *Megommation* and its position in augochlorine phylogeny briefly discussed. The group is diagnosed and the male is described for the first time. Two species are described, figured, and keyed for the genus; the type species *Megaloptilla callopis* (Vachal) new combination, and *M. byronella* new species. *Megaloptilla callopis* is found in Colombia and Peru, whereas *M. byronella* is known only from Panamá.

Keywords: Apoidea; Augochlorini; Neotropics; Taxonomy.

INTRODUCTION

Bees of the halictine tribe Augochlorini range from southern Canada to Argentina and Chile. At present, the tribe includes approximately 500 species classified into 38 extant genera and subgenera, along with three species in the fossil genus *Oligochlora*. Although their range covers a greater portion of the western hemisphere, augochlorines are most diverse in South America.

The augochlorine genus *Megaloptilla* was originally proposed by Moure and Hurd (1987) as a subgenus of *Megommation*, a member of a clade of genera with a greatly narrowed labiomaxillary complex and a distinctly pointed galeal apex. Examination of the female lectotype designated by these same authors for the type species, *H. callopis* Vachal, reveals an unmodified labiomaxillary complex, a broadly rounded galeal apex, and little affinity to *Megommation* or any of its relatives. The male was unknown at the time of Moure and Hurd's work, but has recently been identified along with a second species of the genus. *Megaloptilla* is similar in general appearance to species of *Caenaugochlora*, or even more strongly to species of *Paroxystoglossa*, from both of which it is differentiated below.

In a cladistic analysis of the augochlorine genera (Engel, 1998) *Megaloptilla* is part of a large clade containing genera such as *Augochlora*, *Augochlorella*, *Ceratalictus*, *Paroxystoglossa*, and *Pereirapis*. This group is part of a larger clade containing genera such as *Caenaugochlora*, *Megalopta*, *Thectochlora*, and *Chlerogella* among others. These taxa are grouped on the combination of a distinctly narrowed spiculum on S8 of males, an acute apex to the marginal cell (although this is reversed in 2 genera), poorly developed teeth on the labral margins (ultimately modified in *Augochlora* and *Pereirapis*), a serrate inner hind tibial spur, and an entirely rimmed basitibial plate (reversed in 1 genus).

Megaloptilla and *Paroxystoglossa* fall outside of the eusocial group (composed of *Augochlorella*, *Pereirapis*, *Ceratalictus*, and *Augochlora*) by lacking a carinate preoccipital ridge. *Megaloptilla* monophyly is supported by the unmodified venter of the penis valve and the bilobed process on the apical margin of the male S7; while the species of *Paroxystoglossa* are united by the obtuse epistomal sulcus, the truncated marginal cell apex, and the high projecting and strongly narrowed anterior mesoscutal border. The cladistic position of *Megaloptilla* among augochlorine genera will be treated in further detail in a forthcoming paper concerning the entire tribe (Engel, 1998).

ACKNOWLEDGMENTS

MSE was supported by a National Science Foundation Predoctoral Fellowship and an Ernst Mayr Award from the Museum of Comparative Zoology, Harvard University. MSE is sincerely thankful to Mme. J. Casevitz-Weulersse (Museum National d'Histoire Naturelle, Paris), G. Else, and S. Lewis (both of the British Museum, Natural History) for kindly hosting him during his stay at their respective institutions. We are indebted to G.W. Byers, B.N. Danforth, and C.D. Michener for constructive criticisms on the manuscript which greatly improved the final version. This work is lovingly dedicated to the memory of Byron A. Alexander (1952–1996). Byron was a dear friend whose intellect was only surpassed by his kindness. This paper is contribution No. 3193 of the Snow Entomological Collection, University of Kansas Natural History Museum.

MATERIAL AND METHODS

Specimens of *Megaloptilla* were found in the following institutions and made available to us by the named individuals: the Natural History Museum (British Museum), London, G. Else and S. Lewis (BMNH); Cornell University Insect Collection, Ithaca, New York, J.K. Liebherr and

¹ Department of Entomology, Comstock Hall, Cornell University, Ithaca, New York 14853. Present address: Department of Entomology, American Museum of Natural History, Central Park West at 79th St., New York, NY 10024. E-mail: engel@amnh.org

² Snow Entomological Collection, Division of Entomology, Natural History Museum, University of Kansas, Lawrence, Kansas 66045.

R.E. Hoebeke (CUIC); Museum National d'Histoire Naturelle, Paris, J. Casevitz-Weulersse (MNHN); National Museum of Natural History, Smithsonian Institution, Washington, D.C., R.J. McGinley (USNM); Snow Entomological Collection, Division of Entomology, Natural History Museum, University of Kansas, Lawrence, Kansas (SEMC); and the Smithsonian Tropical Research Institute, Panamá City, Panamá, D. Roubik (STRI).

In the descriptions the following abbreviations are used for morphological terms: F, flagellomere; S, sternum; T, tergum. All measurements were made using an ocular micrometer on a WILD-M5a microscope. Measures given in the descriptions are for the type specimens with ranges of variation for critical values given in parentheses.

SYSTEMATICS

Genus *Megaloptilla* Moure and Hurd, new rank

Megommation (*Megaloptilla*) Moure and Hurd, 1987:241. Type species: *Halictus callopis* Vachal, 1911, monobasic and original designation. Engel, 1998: 123

Megommation (*Emgaloptilla*) Moure and Hurd, 1987:vi. *Lapsus calami* for *Megaloptilla* Moure and Hurd, 1987.

Diagnosis.—Members of *Megaloptilla* generally resemble species of *Caenagochlora* (s.str.) and *Paroxystoglossa*. It differs from the first genus by the more obtuse epistomal sulcus, transverse labral basal elevation, rounded preoccipital ridge, very slightly narrowed mesoscutum, and serrate inner hind tibial spur. From the latter it differs in the rounded preoccipital ridge, transverse labral basal elevation, acute apex of the marginal cell, and very weakly narrowed mesoscutum (in *Paroxystoglossa* the mesoscutum is strongly narrowed, high, and projecting forward).

Description.—The following description is based on the two presently included species:

Female: Epistomal sulcus roughly orthogonal (Figs. 2, 11). Clypeus and supraclypeal area convex and slightly protuberant. Malar space short. Preoccipital ridge rounded. Inner margin of compound eye moderately emarginate; eyes moderately convergent below; eye hairs short. Ocelli of normal size, not greatly enlarged; interocellar furrow absent. Vertex normal, not greatly expanded posteriorly. Labral basal elevation transverse, protuberant; distal process narrowly triangular, teeth weak. Mandible strongly bidentate due to well-defined subapical tooth; supplementary tooth on inner margin of mandible. Hypostomal ridge carinate, anterior angle rounded, not projecting posteriorly beyond distal margin of head. Distal portion of maxilla normal; galeal apex lobed, inner strip with setae and cuticular markings, base of galea equal to base of stipes; galeal comb absent; maxillary palpus normal. Prementum normal; salivary plate with V-shaped brace; segments 2+3 of labial palpus longer than 1; glossa of moderate length, less

than half length of prementum. Pronotal lateral angle obtuse, not produced; lateral ridge rounded; dorsal ridge strongly carinate, weakly lamellate in some areas. Mesoscutum slightly narrowed anteriorly, mesoscutal lip low and rounded. Tegula rounded. Propodeal triangle subequal to scutellum, longer than metanotum; propodeal dorsal ridge rounded; lateral ridge rounded, ridges slightly divergent; propodeum not narrowed posteriorly; pit of posterior face narrow. Marginal cell with acute apex (Fig. 1). Distal hamuli arranged 2-1-2 on hind wing margin. Anterior basitarsal brush present. Inner hind tibial spur serrate, serrations sharp (Fig. 14). Scopa formed of long, plumose hairs on hind femur and tibia (Figs. 4, 13). Basitibial plate narrowly rounded, well defined on all edges. Metasoma unmodified.

Male: Mandible simple. Labrum without basal elevation, without distal process. Scape of moderate length, reaching to lateral ocellus; F2 longer than F1; antenna of moderate length, reaching back to scutellum. Metasoma oval, not elongated. Apical margins of S3-4 unmodified. Apical margin of S5 weakly emarginate; S6 more narrowly and deeply emarginate (Fig. 8). Male terminalia as in figures 8-10.

Identification.—The following key couplets are for Eickwort's (1969) keys to the genera and subgenera of Augochlorini. The male runs to Eickwort's couplet 22. This couplet should be entirely replaced by the version given below. Eickwort's version separates males of *Corynurella* from *Rhectomia*. *Corynurella* is a junior synonym of *Rhectomia* (Engel, 1995); therefore our modified couplet only separates *Rhectomia* from *Megaloptilla*. Couplet 13' is an additional couplet which should be inserted into his key to females. In the following couplets eye emargination is determined following Eickwort (1969: 377). A new key to the genera and subgenera of the Augochlorini is in preparation by one of us (Engel, 1998).

Males

- 22 Mesoscutum weakly narrowed anteriorly; marginal cell apex acute; F2 longer than F1, F2 as long as immediately following flagellomeres *Megaloptilla*
— Mesoscutum broadly rounded anteriorly; marginal cell apex truncate; F2 as long as F1, or if F2 slightly shorter than F1, then F2 distinctly shorter than immediately following flagellomeres *Rhectomia*

Females

- 13 Compound eyes moderately emarginate ($w/l < .11$); propodeal triangle roughened, with striae or plicae; preoccipital ridge rounded or sharply angled 13'
— Compound eyes deeply emarginate ($w/l > .125$); propodeal triangle smooth or granular; preoccipital ridge rounded *Corynura* (s.str.)

- 13' Preoccipital ridge sharply angled; marginal cell apex truncate; mesoscutum strongly narrowed anteriorly, lip high and sharply angled; labral basal elevation orbiculate *Paroxystglossa*
- Preoccipital ridge rounded; marginal cell apex acute; mesoscutum very slightly narrowed anteriorly, lip low and rounded; labral basal elevation transverse *Megaloptilla*

Key to the Species of *Megaloptilla*

- 1 Pleura brown with metallic green reflections; hypopimeron minutely punctured; Sc+R more strongly pigmented than other wing veins; propodeal dorsal ridge rounded; metasoma brown with red-copper reflections, integument smooth with minute punctures *M. callopis*
- Pleura yellow-orange, without reflections; hypopimeron smooth, without punctures; wing veins evenly pigmented, or at least Sc+R no more strongly pigmented than C; propodeal dorsal ridge with short medial carina; metasoma yellow-orange, integument imbricate *M. byronella*

Megaloptilla callopis (Vachal), new combination
(Figs. 1–10, 15, 16)*Halictus callopis* Vachal, 1911:41.*Oxystoglossidia callopis* (Vachal); Moure, 1944:69.*Megonumation (Megaloptilla) callopis* (Vachal); Moure and Hurd, 1987:241, female lectotype designation.**Lectotype.**—PERU: Cuzco: Female (Figs. 15–16), Marcapata, Vachal collection (MNHN), examined by MSE.**Additional material.**—COLOMBIA: *Putumayo*: One female, Mocoa, 21 August 1978, M. Cooper, B.M. 1978-431 (BMNH). One female, Mocoa, c. 600 m, 31 May–7 June 1976, M. Cooper, B.M. 1976-354 (BMNH). One female, Mocoa, c. 600 m, 26 March–6 April 1976, M. Cooper, B.M. 1976-290 (BMNH). PERU: *Cuzco*: One female, Marcapata, Vachal collection (MNHN). *San Martin*: Two males, Rioja, 14 December 1978, M. Cooper, B.M. 1979-20 (BMNH). *Ucayali*: One female, Boquerón [del Padre] Abad, 18 December 1961, J.M. Schunke, B.M. 1962-491 (BMNH).**Diagnosis.**—Mesoscutum brown with metallic green and copper reflections. Pleura brown with metallic green reflections. Hypopimeron minutely punctured. Crossvein 1r-m distad 1m-cu; Sc+R more strongly pigmented than other wing veins. Scopal hairs of hind tibia reaching to tibial apex (Fig. 4). Propodeal dorsal ridge rounded. Metasoma brown with red-copper reflections, integument smooth with minute punctures.**Description.**—The following description is based on the lectotype female and a male from the Natural History Museum, London:**Female: Structure.** Total body length 8.14 mm (7.9–8.54 mm); forewing 6.56 mm long (6.4–8.2 mm). Head longer than wide (length 2.18 mm, width 1.94 mm) (Fig. 2). Distal two thirds of clypeus projecting below lower tangent of compound eyes; supraclypeal area slightly shorter than clypeus. Frontal line carinate between antennae to half distance to median ocellus, becoming a weakly impressed line from that point on. Scape 0.92 mm long; pedicel about as long as wide, about as long as F1; F1 as long as wide; F2 slightly longer than wide, longer than F1. Distance from median ocellus to lateral ocellus 0.06 mm; between lateral ocelli 0.26 mm; lateral ocellus to compound eye 0.32 mm. Genal width roughly equal to that of compound eye in profile (Fig. 3). Intertegular distance 1.4 mm (1.4–1.7 mm). Scutellum 1.5 times longer than metanotum. Propodeal triangle almost as long as scutellum; dorsal ridge rounded. Basal vein distad cu-a by 3 times width of vein (Fig. 1); 1r-m distad 1m-cu by width of vein; 2r-m distad 2m-cu by 2 times width of vein; 2r-m relatively straight. First submarginal cell longer than second and third submarginal cells combined; second only slightly narrowed anteriorly.**Coloration and sculpturing.** Mandible amber, except red-brown at apex and base. Labrum amber. Distal half of clypeus amber, remainder brown with a few metallic green-copper reflections; amber patch smooth, remainder of clypeus with sparse weak punctures separated by 1–3 puncture widths, integument between punctures smooth (Fig. 2). Supraclypeal area brown with reflections as on basal half of clypeus, integument as on clypeus. Head brown with strong metallic green and weak copper reflections; face densely punctured, punctures separated by less than their width, integument between punctures smooth. Scape amber, pedicel and flagellum light brown. Vertex with minute punctures separated by twice their width, integument otherwise smooth. Gena and postgena weakly imbricate; postgena without metallic green reflections. Pronotum brown, amber at lobe and ventrally on lateral surfaces, a few weak metallic green reflections dorsally, integument smooth. Mesoscutum colored as face; minutely punctured, punctures separated by 2–5 puncture widths, integument otherwise smooth; median and parapsidal lines weakly impressed. Tegula amber and semi-translucent. Scutellum colored as mesoscutum, except punctures deeper and separated by 1–3 times puncture width. Metanotum as scutellum, copper reflections strong, minute punctures separated by 2–4 times puncture width, integument weakly roughened. Pre-episternum with strong metallic green reflections; small punctures separated by a puncture width or less, integument otherwise smooth. Mesepisternum colored as pre-episternum; small punctures separated by a puncture width or less, except ventrally punctures becoming more widely scattered.

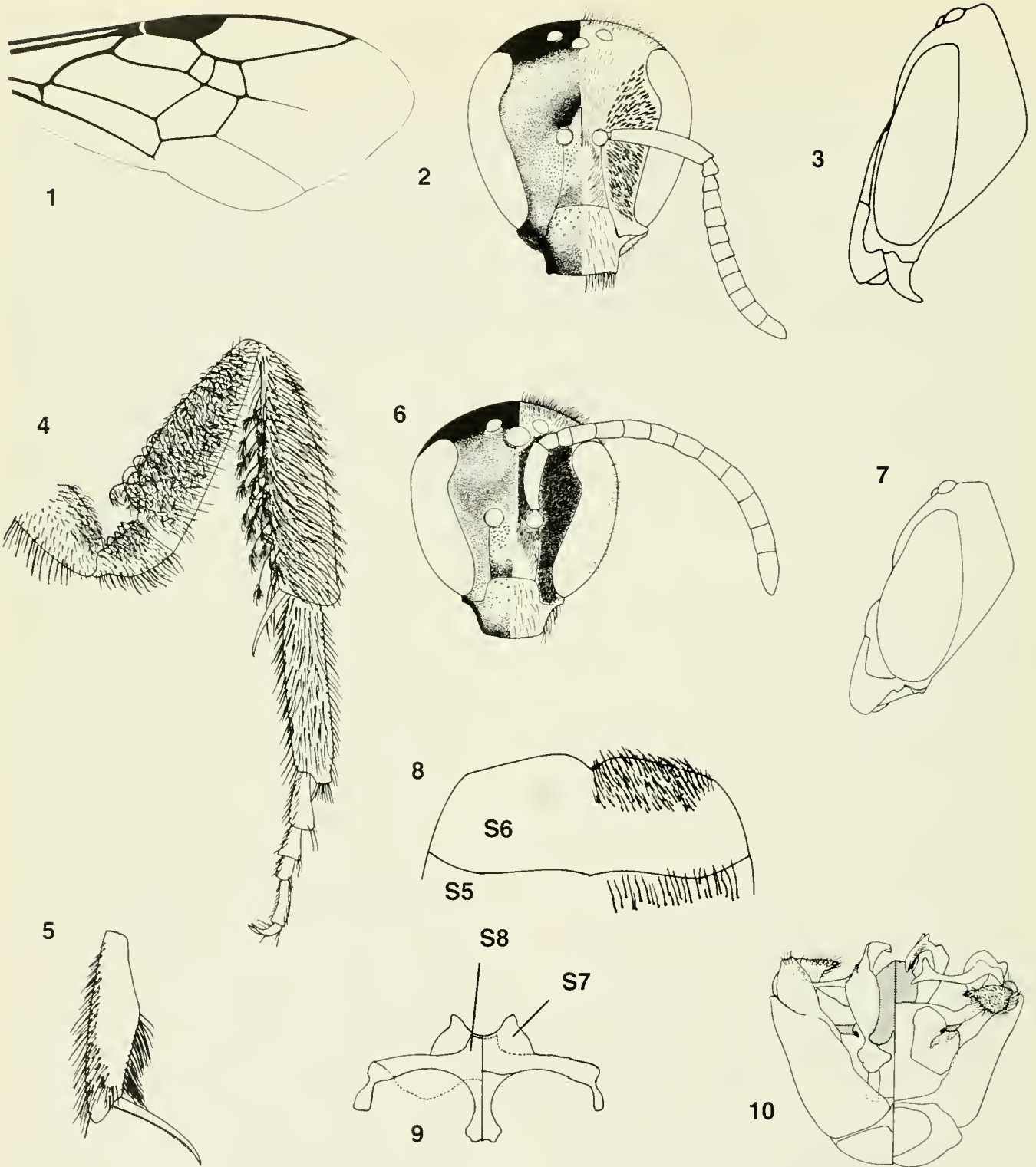

Figs. 1-10. *Megaloptilla callopis* (Vachal). 1-Forewing venation. 2-Front view of female face. 3-Lateral view of female head. 4-Hind leg. 5-Mesotibia. 6-Front view of male face. 7-Lateral view of male head. 8-Male sternite 5 and 6. 9-Male sternite 7 and 8. 10-Male genitalia; left half is dorsal, right half is ventral.

Hypoepimeron minutely punctured, punctures separated by 1–3 times puncture width, integument otherwise smooth, colored as on remainder of mesepisternum. Metepisternum colored as on mesepisternum; punctured as on hypoepimeron, except punctures more widely scattered and weaker ventrally. Legs amber. Wing veins amber, except Sc+R brown. Lateral and posterior propodeal surfaces imbricate. Propodeal triangle brown with strong copper and weak green reflections; surface strongly imbricate with reticulating rugae. Metasomal terga brown with strong red-copper reflections; integument smooth with minute punctures separated by 2–4 times puncture width. Sterna brown and weakly imbricate.

Pubescence. Pubescence pale to golden. Clypeus, supraclypeal area, and face with sparse simple hairs; face with additional short, suberect, plumose hairs nearly obscuring integument. Vertex and gena with scattered short, simple hairs. Postgena with widely scattered long, simple hairs; hairs on border with gena with a few short branches. Lateral surface or pronotum with extremely short, fine, simple appressed hairs, not obscuring the surface. Mesoscutum with scattered, simple hairs. Scutellum as on mesoscutum, with additional longer, simple hairs, a few with short branches. Pre-episternal sulcus covered with short, suberect, plumose hairs. Lateral and posterior propodeal surfaces with scattered, long hairs each with a few branches; additional short, suberect, simple hairs, not obscuring surface. T1–2 with sparse, simple hairs. T3–4 with hairs becoming more dense and longer. Sterna with scattered long, simple hairs.

Male: As in the female with the following modifications. Total body length 9.36 mm (9.3–9.36 mm); forewing length 7.04 mm (6.94–7.04 mm). Head longer than wide (length 2.24 mm, width 2.02 mm) (Fig. 6). Distal half of clypeus projecting below lower tangent of compound eyes (Fig. 7). Scape 0.64 mm long; pedicel as long as wide, longer than F1; F1 wider than long, about half the length of F2; F2 longer than wide. Distance from median ocellus to lateral ocellus 0.08 mm; between lateral ocelli 0.26 mm; lateral ocellus to compound eye 0.24 mm. Intertegular distance 1.42 mm (1.40–1.42 mm). Male terminalia as in figures 8–10.

Coloration, sculpturing, and pubescence as in the female, except for usual sex differences in pilosity.

Remarks.—One male from the Natural History Museum, London, has several mites clinging to the anterior surface of the first metasomal tergum.

Megaloptilla byronella new species
(Figs. 11–14)

Holotype.—PANAMÁ: *Darién*: Cana Biological Station, Serrania de Pirre, 1250 m, 7°45'18"N, 77°41'6"W,

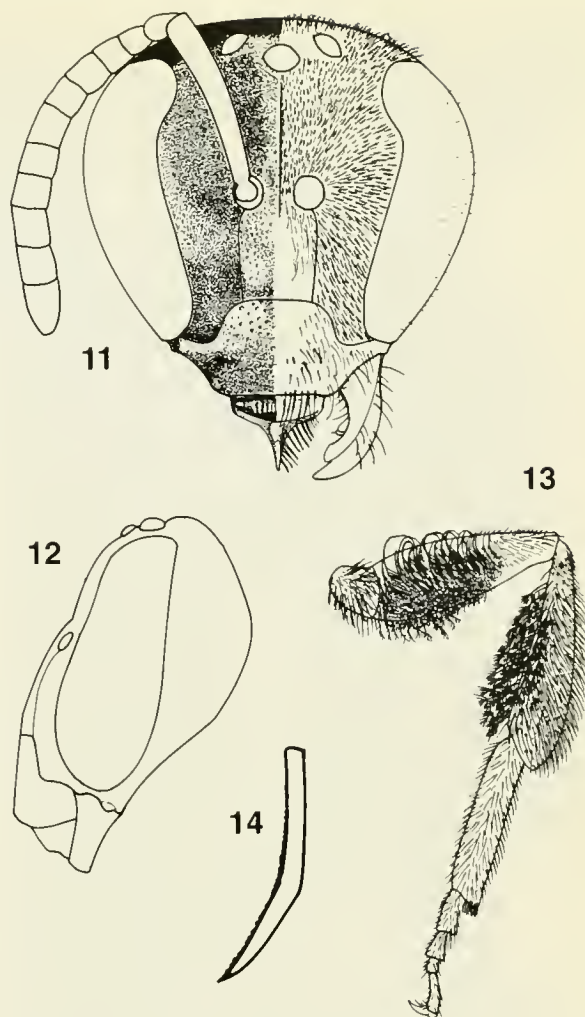

Figs. 11–14. *Megaloptilla byronella* n. sp. 11—Front view of female face. 12—Lateral view of female head. 13—Hind leg. 14—Inner hind tibial spur.

4 June 1996, R.W. Brooks and J.S. Ashe, female, PAN1AB96-106, ex: flight intercept trap (SEMC).

Paratypes.—PANAMÁ: *Panamá*: Capira, Cerro Campana, 18 August 1982, D. Roubik, five females, coming to cineole bait; 6 females, same except 8 September 1982, No. 41 (SEMC, CUIC, USNM, STR1).

Diagnosis.—Mesoscutum black. Pleura yellow-orange, without metallic reflections. Hypoepimeron smooth and impunctate. Crossvein 1r-m confluent with 1m-cu; Sc+R as pigmented as in *C.* Scopal hairs on hind tibia not reaching tibial apex (Fig. 13). Propodeal dorsal ridge with short medial carina. Metasoma yellow-orange, integument imbricate.



15



16

Figs. 15-16. *Megaloptilla callopis* (Vachal), lectotype female. 15-Dorsal habitus. 16-Front view of face.

Description.—The following description is based on the holotype female:

Female: Structure. Total body length 10.64 mm (7.7–13.8 mm); forewing 8.48 mm long (6.6–8.5 mm). Head as long as wide (length, width 2.52 mm) (Fig. 11). Clypeus as long as broad, distal half projecting below lower tangent of compound eyes; supraclypeal area longer than wide. Frontal line carinate between antennae, becoming a moderately impressed line just above antennal sockets. Scape 1.18 mm long; pedicel about as long as F1; F1 about as long as wide; F2 longer and wider than F1, about as long as wide. Distance from median ocellus to lateral ocellus 0.06 mm; between lateral ocelli 0.32 mm; lateral ocellus to compound eye 0.28 mm. Genal width roughly equal to that of compound eye in profile (Fig. 12). Premental length 1.32

mm; width 0.32 mm. Glossal length 0.54 mm. Intertegular distance 1.92 mm (1.4–2.0 mm). Scutellum almost twice as long as metanotum. Propodeal triangle slightly shorter than scutellum; dorsal ridge weakly carinate medially, otherwise rounded. Basal vein distad cu-a by 2 times width of vein; 1r-m confluent with 1m-cu; 2r-m distad 2m-cu by 4.5 times width of vein. First submarginal cell only slightly longer than second and third combined; second narrowed anteriorly.

Coloration and sculpturing. Mandible yellow-orange, red-brown at apex. Clypeus yellow-orange, shallow punctures generally separated by more than a puncture width, integument between punctures smooth. Supraclypeal area dark brown, sometimes orange basally; sculptured as clypeus except punctures finer. Scape yellow, remainder

of antenna brown. Face dark brown with dull metallic green reflections; closely punctate, punctures minute and separated by width of puncture or less, integument between smooth (Fig. 11). Vertex, gena and postgena dark brown; vertex and gena punctured as face, postgena imbricate and impunctate. Prothorax yellow-orange, surface imbricate. Mesoscutum black with scattered minute punctures, integument smooth. Tegula light brown, weakly imbricate. Scutellum yellow-orange; sculptured as mesoscutum except punctures more dense. Metanotum brown and dull. Pleura largely yellow-orange with surface finely imbricate, becoming granular ventrally; hypopimeron entirely smooth. Wings slightly yellowed; veins evenly pigmented and amber. Legs entirely yellow-orange. Propodeal triangle red-brown or brown, remainder of area yellow-orange; triangle rugose, more finely so at center, rugosity not extending to margins of basal area, surface imbricate. Lateral surface of propodeum yellow-orange, posterior surface darkened; surface finely imbricate or granular. Metasoma yellow-orange, finely imbricate, with widely scattered weak punctures, except anterior surface of T1 smooth; dense, minute punctures on disks of T1-2.

Pubescence. Clypeus and supraclypeal area with scattered long, simple hairs. Face, vertex, and gena with short, golden, appressed hairs, not obscuring surface; becoming plumose laterally on face, and below on gena (Fig. 11), intermixed with scattered simple hairs. Postgena with long hairs sparse except row along hypostomal carina. Pronotal dorsal surface and pronotal lobes covered with dense pale hairs intermixed with scattered erect hairs. Mesoscutum with short, subappressed hairs along margins; slightly longer, erect hairs scattered across surface. Tegula with

hairs on inner and anterior margins. Posterior half of scutellum with very long, orange hairs. Metanotum with long, plumose, yellow hairs and shorter, suberect, plumose hairs. Pleura with simple yellow hairs, a few with short branches; hairs sparse on hypopimeron, hairs becoming longer ventrally. Legs with golden pubescence. Lateral and posterior surfaces of propodeum with long, yellow hairs and layer of very short, simple hairs obscuring the surface. Anterior surface of T1 without pubescence; disks of T1-2 with minute hairs intermixed with scattered, short, suberect, yellow hairs becoming progressively longer and more widely scattered on T3-4. T5 with similar hairs of moderate length and more numerous than on preceding terga. Sterna with long, erect, yellow hairs along apical margins.

Male: Unknown.

Etymology.—This species is named in honor of the late Byron A. Alexander.

LITERATURE CITED

- Eickwort, G. C. 1969. A comparative morphological study and generic revision of the augochlorine bees (Hymenoptera: Halictidae). University of Kansas Science Bulletin 48:325-524.
- Engel, M. S. 1995. The bee genus *Rhectomia* (Hymenoptera: Halictidae): discovery of the male and two new species. Journal of the New York Entomological Society 103:302-310.
- Engel, M. S. 1998. Phylogeny, classification, and evolutionary ethology of the bee tribe Augochlorini (Hymenoptera: Halictidae). Ph. D. Dissertation, Cornell University, Ithaca, New York, xxii+306 pp.
- Moure, J. S. 1944. Abejas del Perú. Boletín del Museo de Historia Natural, "Javier Prado" 8:67-75.
- Moure, J. S. and P. D. Hurd, Jr. 1987. An annotated catalog of halictid bees of the Western Hemisphere (Hymenoptera: Halictidae). Smithsonian Institution Press, Washington, D.C., vii + 405 pp.
- Vachal, J. 1911. Étude sur les *Halictus* d'Amérique (Hym.). Miscellanea Entomologica 19:9-24, 41-56, 107-112.

Redescription of *Linsleyonides* Skiles (Coleoptera: Cerambycidae) and Inclusion of *Elaphidion portoricensis* Fisher

By

STEVEN W. LINGAFELTER¹

ABSTRACT *Elaphidion portoricensis* Fisher is transferred to *Linsleyonides* based on four hypothesized autapomorphies for the genus. *Linsleyonides* is redescribed and diagnostic characters are illustrated. Differences between *Linsleyonides* and the closely related *Elaphidion* are discussed. A key for the three species of *Linsleyonides* is presented.

Key words: Systematics, Taxonomy, West Indies, Longhorned Woodborers.

INTRODUCTION

Linsleyonides is a member of the tribe Elaphidiini. This West Indian genus was proposed by Skiles (1985) to accommodate 2 species: *L. albomaculatus* (Champlain & Knull, 1922) and *L. chemsaki* (Skiles, 1985). *Elaphidion portoricensis* Fisher is transferred to *Linsleyonides* because it possesses four character states shared by the other two species of *Linsleyonides* (hypothesized autapomorphies of the genus) which are not known from other elaphidiine taxa. Additionally, *L. portoricensis* lacks the hypothesized synapomorphies of *Elaphidion* and other potentially closely related genera. *Linsleyonides* is redescribed below, and many of the diagnostic morphological features are illustrated. Parenthetical notations are included to indicate hypothesized autapomorphies and deviations from or agreement with Skiles' 1985 description.

ACKNOWLEDGMENTS

I thank Michael Ivie for bringing this misplaced taxon to my attention and providing me with many specimens for character analysis. His generosity in accommodating me on a research trip to Montana State University to study this and other West Indian elaphidiine taxa is very much appreciated. The habitus illustration was nicely rendered by Elizabeth Roberts. I thank Steve Ashe and Byron Alexander for my training and their support of my studies on Cerambycidae while at the University of Kansas. I thank David Furth, Darlene Judd, Alexander Konstantinov, Allen Norrbom, Norman Woodley, and two anonymous reviewers for constructive comments on this manuscript.

SYSTEMATICS

Linsleyonides Skiles

Linsleyonides Skiles, 1985: 316. Type species, *Elaphidion albomaculatum* Champlain & Knull, by original designation.

Description.—*Size:* small to moderate (7–20 mm). *Head:* eye large and coarsely faceted, occupying more than 50% of the exposed region of the head when viewed laterally; distinct, rounded or triangular patches of dense, white or yellow, supraocular pubescence present (Figs. 1–3) (**Autapomorphy**); frontoclypeal margin arcuate with lateral pits present (first mentioned by Skiles, 1985) (Fig. 5) (**Autapomorphy**); mandible with a narrow incisor region (less than one-third width of base of mandible when viewed from mesal or biting surface) and an apical and basal indentation separated by an undentate plateau; terminal labial palpomere without digitiform sensillum; terminal maxillary palpomere expanded apically, apical width over half length with distinct, narrow digitiform sensillum (Fig. 6); antenna of female strongly spined apicomeresally on antennomeres 3–6, weakly so on antennomere 7; antenna of male, strongly spined mesally on antennomeres 3–5, weakly so on antennomeres 6–7; antenna not spined laterally; antennomeres gradually widened at apices, particularly after antennomere 6; antenna without carina (Skiles, 1985 indicates antennae are partially, dorsally carinate, but my clearing of a specimen did not reveal this); antennomere three about two-thirds length of pronotum in male, slightly longer than half length of pronotum in female; terminal antennomere without pseudo-segmental constriction or setae. *Prothorax:* raised median callus and peripheral calli present on pronotum; procoxal cavities open posteriorly; prosternal intercoxal process only slightly expanded apically, gradually declivous posteriorly; lateral margin of procoxal cavity closed (trochantin hidden, propleuron and prosternum fused very close to coxa); pronotum without lateral tubercle or transverse ridges on pronotal disc; prosternum more heavily pubescent in female than male. *Mesothorax:* mesocoxal cavity closed or barely open laterally (mesepimeron contacting mesocoxae directly in some

¹ Systematic Entomology Laboratory, PSI, ARS, USDA, c/o U.S. National Museum of Natural History, MRC-168, Washington, D.C. 20560.
E-mail: slingafelter@sel.barc.usda.gov

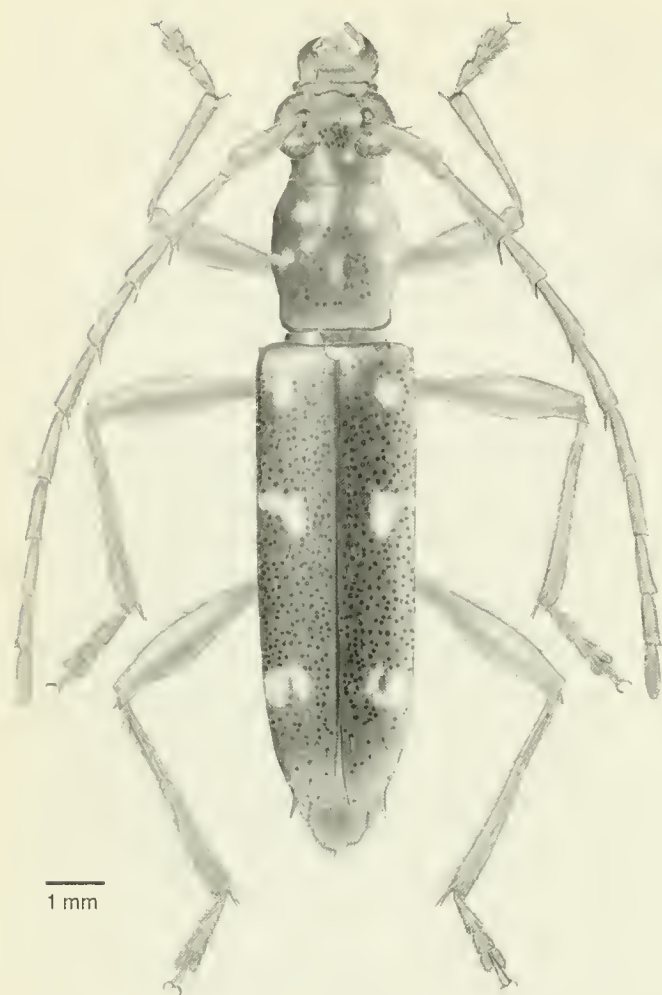
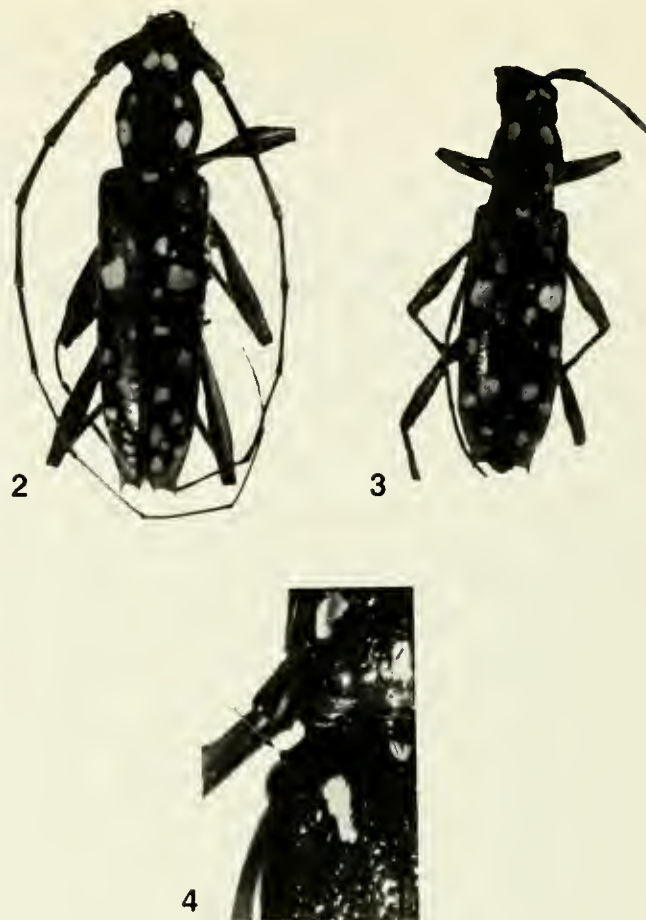

Fig. 1. Habitus of *Linsleyonides portoricensis* (Fisher), female.



Figs. 2-4. Habiti and diagnostic characters of *Linsleyonides*. 2—Habitus of *L. chemsaki* Skiles, male. 3—Habitus of *L. albomaculatus* (Champlain & Knull), male. 4—Epipleural tooth on *L. portoricensis*.

specimens, in others, closure of metasternum and mesosternum prevents this contact); anterior margin of mesosternum as in Fig. 9; intercoxal process of mesosternum with small, indistinct lateral projection into acetabular excavation in mesocoxa; wide, truncate notch in mesosternal intercoxal process; anterior margin of mesonotum broadly rounded (Fig. 8); mesoprescutum (scutellum) with basal constriction and small apical notch on otherwise rounded posterior margin (Fig. 8); mesepisternal carina evenly arcuate (Fig. 7). *Metathorax*: metasternal notch acute; metasternal sulcus incomplete, only attaining anterior one-third of metasternum; metepisternum with longitudinal keel positioned equidistant from dorsal and ventral margin, more heavily sclerotized ventral to keel; metepisternal notch at posterior margin narrow and reaching approximately half way to keel. *Legs*: mesal and lateral mesofemoral apices dentiform to weakly spinose; mesal

and lateral metafemoral apices spinose; metafemur linear to slightly enlarged at middle; metafemur finely punctate; meso and metatibia with very reduced carina proximally, not visible distally; metacoxa with pronounced ridges on anterior face. *Wings*: elytron with scattered spots of dense white or yellow pubescence (Figs. 1-3) (**Autapomorphy**); elytral humerus with small, distinct tooth (Fig. 4) (**Autapomorphy**); elytra with strong apicolateral spine and dentiform sutural angle; hind wing MP-CuA incomplete, not contacting MP1+2; hind wing without CuA1+2.

Diagnostic characters.—The hypothesized autapomorphies for *Linsleyonides* include the distinct postocular patches of pubescence as well as the small, dense, pubescent patches on the elytra (Figs. 1-3); the elytral humerus with a small epipleural tooth (but also present in some *Eburiini*, Fig. 4); and the arcuate frontoclypeal suture with

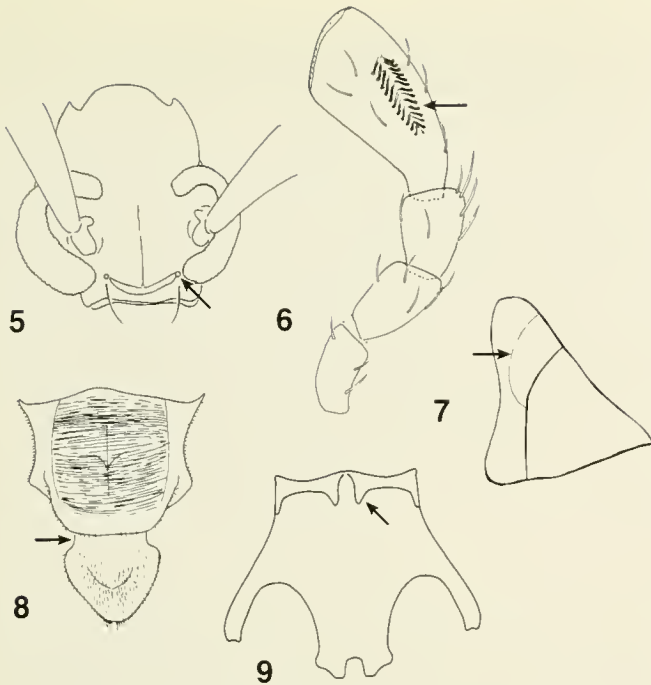

Figs. 5–9. Diagnostic characters of *Linsleyonides*. 5–Head showing frontoclypeal pits. 6–Maxillary palpus showing medially positioned digitiform sensillum. 7–Mesepisternum (anterior to the left) showing arcuate carina. 8–Mesonotum and scutellum (anterior to top) showing constricted scutellar base. 9–Mesosternum showing sclerotized pattern on anterior margin.

lateral pits (first discussed by Skiles, 1985) (Fig. 5). Other diagnostic characters not widely distributed in Elaphidiini include the incomplete metasternal sulcus; terminal antennomere without subapical setae and without pseudoantennomere constriction; and the sclerotization pattern of the anterior margin of the mesosternum (Fig. 9).

Distribution and Diversity of *Linsleyonides*.—This attractive genus occurs in extreme southeastern United States and the West Indies; particularly southern Florida and Cuba (*L. albomaculatus*), Virgin Islands and Puerto Rico (*L. portoricensis*), and Jamaica (*L. chemsaki*).

Discussion.—*Linsleyonides* and *Elaphidion* share the basic form of the sclerotization of the anterior margin of the mesosternum, but in *Linsleyonides* there is a posterior medial projection (see arrow, Fig. 9). Additionally, the mesofemoral and antennal spines in *Linsleyonides* are not as prominent as in *Elaphidion*, and *Linsleyonides* lacks the abruptly declivous prosternal intercoxal process characteristic of *Elaphidion*.

A phylogenetic analysis of Elaphidiini (Lingafelter, 1998) using implied weights (PIWE, Goloboff, 1993) showed *Linsleyonides* to be closely related to several genera including *Elaphidion* Audinet-Serville, *Curtomerus*

Stephens, and *Eburia* Lepeletier & Audinet-Serville. An equal weighting phylogenetic analysis of the same taxa in that study (Lingafelter, 1998) using PAUP (Swofford, 1991) showed *Linsleyonides* to be a sister taxon to other *Elaphidion* exemplars. These analyses used an exemplar approach and included *L. portoricensis*. Because the type species of the genus, *L. albomaculatus*, and some potentially closely related West Indian genera were not available for dissection and inclusion in that study, further analyses are required for a robust hypothesis of relationships among these closely related genera.

SPECIES CATALOG OF *LINSLEYONIDES*

Linsleyonides albomaculatus (Champlain and Knull), 1922: 146. Originally described as *Elaphidion*, transferred to *Elaphidionoides* by Linsley (1963), then placed in *Linsleyonides* by Skiles (1985). Designated as type species of *Linsleyonides* by Skiles (1985: 316). Type locality: Miami, Florida. Type deposition: Field Museum of Natural History (Chicago, Illinois); not examined.

Linsleyonides chemsaki Skiles, 1985: 317. Type locality: Hardwar Gap, Jamaica. Type deposition: Canadian National Collection, Agriculture Canada (Ottawa, Ontario); examined.

Linsleyonides portoricensis (Fisher), 1932: 33. **New Combination**, transferred from *Elaphidion*. Type locality: Coamo Springs, Puerto Rico. Type deposition: American Museum of Natural History (New York, New York); examined.

Key to species of *Linsleyonides*

1. Postocular pubescence in large, rounded, contiguous patches (Fig. 2); patches of pubescence on head, pronotum, and elytra yellow; pronotal disc with four round patches, anterior two smaller than posterior two *L. chemsaki* Skiles
- Postocular pubescence in small, triangular, typically non-contiguous patches (Figs. 1, 3); patches of pubescence on head, pronotum, and elytra white; pronotal disc with four or six patches, anterior two rounded and larger than the others 2
2. Each elytron with at least seven distinct, rounded patches of pubescence of differing sizes (Fig. 3) *L. albomaculatus* (Champlain & Knull)
- Each elytron with three triangular or irregularly shaped patches of pubescence (positioned basally, antemedially, and at posterior one-third) (Fig. 1) *L. portoricensis* (Fisher)

LITERATURE CITED

- Champlain, A. B. and J. N. Knull. 1922. New North American Coleoptera. *Entomological News* 33: 144-149.
- Fisher, W. S. 1932. New West Indian cerambycid beetles. *Proceedings of the United States National Museum* 80(22): 1-93.
- Goloboff, P. A. 1993. *Pee-Wee*, Version 2.1. Program and documentation. New York, NY.
- Lingafelter, S. W. 1998. The genera of Elaphidiini Thomson, 1864 (Coleoptera: Cerambycidae). *Memoirs of the Entomological Society of Washington* 20: 1-118.
- Linsley, E. G. 1963. The Cerambycidae of North America. Part IV. Taxonomy and classification of the subfamily Cerambycinae, tribes Elaphidionini through Rhinotragini. *University of California Publications in Entomology* 21: 1-165.
- Skiles, D. D. 1985. New genera and species of elaphidionine Cerambycidae (Coleoptera) from North America and the West Indies. *The Coleopterist's Bulletin* 39: 305-320.
- Swofford, D. L. 1991. *Phylogenetic Analysis Using Parsimony (PAUP)*, version 3.0. Illinois Natural History Survey, Champaign.

Anthidium oblongatum (Illiger): an Old World Bee (Hymenoptera: Megachilidae) New to North America, and New North American Records for Another Adventive Species, *A. manicatum* (L.)

By

E. RICHARD HOEBEKE¹ AND A. G. WHEELER, JR.²

ABSTRACT The palearctic wool-carder bee, *Anthidium oblongatum* (Illiger), is reported from North America for the first time. During 1994–1997, specimens were collected at several localities in Maryland, New Jersey, New York, and Pennsylvania. A description, diagnosis, and illustrations are given, and its native geographic range and bionomics are summarized. New eastern U.S. and Canadian records are given for the adventive *A. manicatum* (L.).

Keywords: Hymenoptera; Megachilidae; *Anthidium oblongatum*; *Anthidium manicatum*; North America; Distribution; Bionomics.

INTRODUCTION

In the autumn of 1983, Byron Alexander—then a relatively youthful Texan who had received a Master’s degree from Colorado State University under the masterful eye of Howard E. Evans—entered a Ph.D. program in entomology at Cornell University, working with the late George Eickwort and pursuing research in the behavior and systematics of *Nomada* bees. While at Cornell, I had the privilege to know Byron on both a personal and professional level. We had the opportunity to travel together, along with several others from Cornell, to Puerto Rico in 1985 and to collect insects for the university collection. And, of course, many exchanges—some humorous and others more sedate and scholarly—took place between Byron and me over the nearly 6 years he spent “high above Cayuga’s waters” on East Hill in Ithaca. Byron was a unique individual, blessed with a witty sense of humor, and there was a certain charm about him. The entomological community at large lost an extremely talented member with the untimely and unanticipated death of Byron Alexander. He was an outstanding teacher, possessed rare artistic ability depicted in his many publications, and was a devoted student of insect natural history, but especially bee systematics, biology, and behavior. Because of his special penchant for bees, I take great pleasure in dedicating this paper—reporting on an exotic bee newly immigrant in North America—to the memory of Byron Alexander. He will be missed, but not forgotten! (E. R. Hoebeke)

Thirty years have passed since the first report of an immigrant bee in the genus *Anthidium* becoming established in North America. Jaycox (1967) recorded the occurrence in the United States of the Old World bee, *A.*

manicatum (L.), based on specimens reared from wooden trap nests in central New York in 1963.

Anthidium manicatum is the most widely distributed *Anthidium* in the world, occurring throughout Europe, the Mediterranean region bordering north Africa, and western Asia. It has been accidentally introduced into Brazil, Argentina, Uruguay, and the Canary Islands (Pasteels, 1969; Schrottky, 1901; Moure and Urban, 1964; Lieftinck, 1958). In North America, this attractive, honey bee-sized species has been recorded from central New York (an area approximately 7,200 km² in Tompkins, Chemung, and Ontario counties) (Jaycox, 1967; Pechuman, 1967; Severinghaus et al., 1981) and from Ontario, Canada (University of Guelph, Guelph, and Freelon) (Smith, 1991).

On 17 October 1995, while approaching the entrance to his former workplace (Bureau of Plant Industry, Pennsylvania Dept. of Agriculture, Harrisburg, PA), AGW observed and collected an interesting bee patrolling flowers of Russian sage (*Perovskia artemesioides* Boiss.) in a small garden. The specimen, a female, was identified by ERH as *Anthidium oblongatum* (Illiger), a species unknown in North America. Since then, additional males and females have been collected in 1996 and 1997 at several localities in a three-state area (Maryland, New York, and Pennsylvania). From June 1994 to June 1996, specimens of *A. oblongatum* were frequently collected from flowers of various weeds at two urban restoration sites and landfills—one each in New Jersey and New York—as part of a study of wild bee pollinators of the weeds of landfills and other post-industrial waste lands (M. Yurlina, in litt.). The above-mentioned records are cited below in Geographic Distribution and mapped in Figure 6.

¹ Department of Entomology, Cornell University, Ithaca, NY 14853. E-mail: erh2@cornell.edu

² Department of Entomology, Clemson University, Clemson, SC 29634. E-mail: awhlr@clemson.edu



Fig. 1. *Anthidium oblongatum*. Female, dorsal habitus. Scale line = 5 mm.

The greatest diversity of *Anthidium* (subg. *Anthidium*) in the U.S. is found in the West, where 25 species are recorded (Hurd, 1979). Only two species of *Anthidium* (subg. *Anthidium*) are known to occur in eastern North America—*A. maculifrons* Smith and *A. psoraleae* Robertson (Mitchell, 1962); however, neither of these species occurs in the Northeast. Before the discovery of *A. manicatum* in New York, no *Anthidium* species were known from New England or the middle Atlantic states.

ACKNOWLEDGMENTS

We thank Michael S. Engel (Cornell University) and Terry L. Griswold (Utah State University, Logan, UT) for their critical review of the manuscript. Mary E. Yurlina (Graduate Program in Ecology and Evolution, Cook College, Rutgers University, New Brunswick, NJ) kindly supplied us with records of *A. oblongatum* taken from wildflowers in landfills and other post-industrial sites in southeastern New York and northern New Jersey. Some Pennsylvania locality records for *A. manicatum* were provided by Ken Long (Carlisle, PA) and Karl Valley (Pennsylvania Dept. of Agriculture, Harrisburg).

SYSTEMATICS

Anthidium oblongatum (Illiger)

Diagnosis.—*Anthidium oblongatum*, a member of the Old World subgenus *Proanthidium* (Michener and Griswold, 1994), differs from members of the nominate subgenus (*Anthidium*) by the presence of a small tooth at each side of the mesoscutellum (Fig. 4) and by the charac-

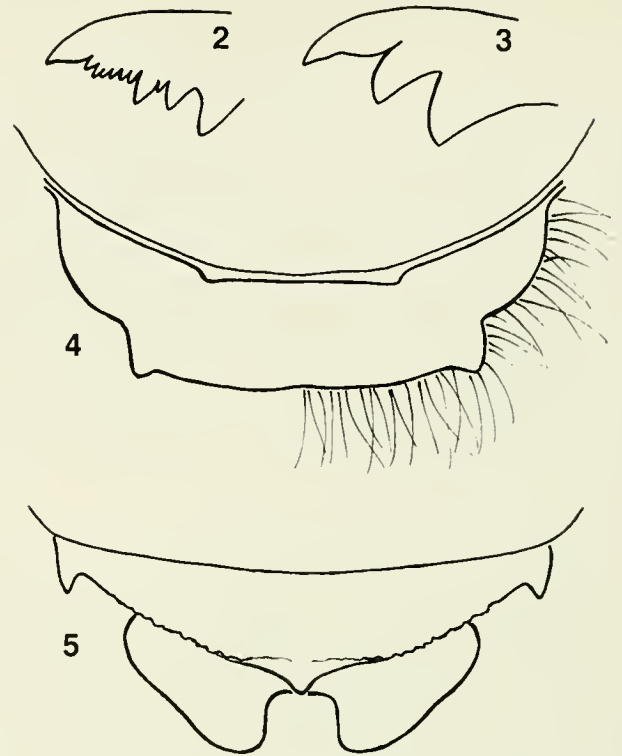

Figs. 2-5. *Anthidium oblongatum*. 2—Female mandible. 3—Male mandible. 4—Mesoscutellum. 5—Terga 6 and 7, male.

teristic bilobed tergum 7 of the male (Fig. 5) (Michener, 1948).

Description.—*Female*: (Fig. 1) Total body length 8–11 mm; forewing length 7–8 mm; black, with yellow maculations; clypeus (except extreme apical margin and, in some specimens, a pair of median irregularly oval spots or maculations black), outer surface of mandibles, lateral facial maculations adjacent to clypeus, and pair of transverse, narrow bands on each side of vertex (sometimes narrowly connected along midline) yellow; tegulae with antero-lateral yellow maculation, small yellow maculation on each axilla, small yellow maculation on lateral margin of mesoscutellum and sometimes yellow spot or band on each side of median line of posterior margin of mesoscutellum; metasomal terga 1–2 with large, triangular, yellow maculations on each side, narrowing considerably towards midline; terga 3–5 with large, transverse, yellow maculations on each side, broadly rounded towards midline; tergum 6 with large, round or quadrate, yellow maculation on each side. Face slightly longer than upper interorbital distance; lateral ocelli nearer margin of vertex than to eyes; genae nearly subequal to width of eyes; clypeus slightly convex, apical margin somewhat thickened on each side; mandibles

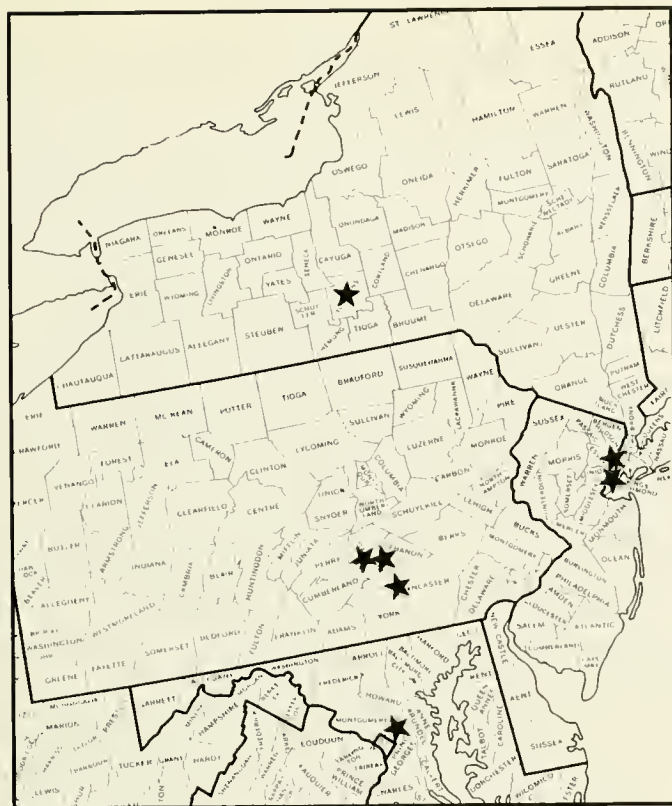

Fig. 6. North American distribution of *Anthidium oblongatum*.

multidentate, with at least 10–11 strikingly dissimilar teeth along inner expanded margin (Fig. 2); vertex and genae bordering preoccipital area not carinate; wings subhyaline to smoky, veins piceous; legs mostly yellowish orange; coxae and trochanters black; front femora black, except apical $\frac{1}{4}$ yellowish; middle and hind femora black except apical $\frac{1}{2}$ yellowish; all tibiae and tarsi yellowish orange with dense, short, white-yellow pubescence; spurs testaceous. Body pubescence moderately short and thin, mostly pale or white, but rather long and dense over clypeus and face, between antennae, on thoracic venter and pleura, and lateral face of propodeum; ventral scopa golden yellow; punctures coarse, moderately dense, nearly contiguous over entire head and thorax; tegulae shining, with mixture of minute and coarse punctures, slightly separated; metasomal terga somewhat shining, punctures quite close but distinct, deep and separated by at least a puncture width, punctures coarser on anterior portion of basal tergum, slightly depressed apical rims of terga 1–5 somewhat more finely and closely punctate, tergum 6 about twice as broad as its median length, broadly triangular, with small median notch on apical margin; lateral margins minutely crenulate.

Male: In overall length and coloration extremely similar to female, differing chiefly in the following char-

acters: mandibles tridentate along inner expanded margin (Fig. 3), tergum 6 with curved spine at each posterolateral margin, and with robust, median projection on apical margin (Fig. 5), and tergum 7 deeply excised at middle and with broadly rounded lobes laterally (Fig. 5).

GEOGRAPHIC DISTRIBUTION

This common palearctic species is found throughout most of southern and temperate Europe, and ranges northward to about 52° latitude (Warncke, 1980; Westrich, 1990); it also occurs in the Alps up to 1500 meters (Westrich, 1990).

In the United States, *A. oblongatum* has been collected at the following localities (Fig. 6): **MARYLAND:** Prince Georges Co., Beltsville, USDA Agric. Research Ctr.-West, 3 September 1997, AGW, ex *Sedum spectabile* (2, CUIC). **NEW JERSEY:** Hudson Co., Kearny (site of old landfill), 1 July 1996, M. E. Yurlina, ex *Melilotus* sp. (1, AMNH; 1, NPIC); 20 July 1995, M. E. Yurlina, ex *Lotus corniculatus* (2, AMNH; 1, NPIC). **NEW YORK:** Richmond Co., Staten Island, west shore (landfill complex), 26 June 1994, 17 and 25 July 1995, M. E. Yurlina, ex *Lotus corniculatus* (4, AMNH; 2, NPIC); 24 August 1995, M. E. Yurlina, ex *Lythrum salicaria* (1, AMNH; 1, NPIC); 25 June 1996, M. E. Yurlina, no host recorded (1, AMNH); 26 August 1996, M. E. Yurlina, ex *Pluchea purpurascens* (1, AMNH). **Tompkins Co.,** Ithaca, Cornell Univ., A. D. White Gardens, 5, 15 September 1997, ERH, ex *Sedum spectabile* (8, CUIC). **PENNSYLVANIA:** Dauphin Co., Harrisburg, 17 October 1995, 6 August 1996, AGW, ex *Peroovskia artemesioides* (2, CUIC); Hershey, Hotel Hershey gardens, 10–11 August 1996, AGW, ex *Sedum spectabile* (16, CUIC; 2, PDA; 2, NPIC)). **Lancaster Co.,** Elizabethtown, Masonic Homes, 11 August 1996, AGW, ex *Sedum* x 'Vera Jameson' (1, CUIC).

Specimens are deposited in the following collections, as indicated by the acronym above: American Museum of Natural History, New York, NY (AMNH), Cornell University, Ithaca, NY (CUIC), Pennsylvania Department of Agriculture, Harrisburg, PA (PDA), and USDA National Pollinating Insects Collection, Logan, UT (NPIC).

BIONOMICS

A univoltine species, *A. oblongatum* flies from mid-June to mid-August and is generally associated with xerophilic vegetation and inhabits mesophytic biotopes in its native habitat (Aliiev, 1986). It overwinters as a diapausing larva in a cocoon. *Anthidium oblongatum* nests in rather dry, warm habitats and is commonly encountered among dry stone walls, in old vineyards, railroad embankments, weathering slopes and rocky outcroppings and ridges, as well as in cultivated and "unmanicured" rock gardens with an abundance of flowers (Westrich, 1990). Nests, composed

of up to eight cells, are constructed in hollowed-out cavities in various substrates, including soil, among bricks, in rock outcrops, between layers of rocks, in rubbish, and occasionally in excavated stems of plants such as thistle and umbellifers (Westrich, 1990). Nesting materials consist of hairs from the following plants: *Stachys germanica* L. and *S. byzantina* L. (Lamiaceae), *Verbascum* (Scrophulariaceae), and *Helichrysum* and *Echinops ritro* L. (Asteraceae). A polylectic species, *A. oblongatum* obtains nectar and pollen from as many as eight plant families (Müller, 1996), but mainly from the Crassulaceae (*Sedum reflexum* L., *S. spurium* Bieb., *S. album* L., *S. acre* L., and *Sempervivum arachnoideum* L.), Fabaceae (=Leguminosae) (*Lotus corniculatus* L., *Onobrychis viciaefolia* Scop., *Melilotus alba* Desr., and *M. officinalis* (L.)), and Resedaceae (*Reseda lutea* L. and *R. luteola* L.) (Westrich, 1990). Its main pollen sources appear to be *L. corniculatus*, *O. viciaefolia*, and *S. reflexum* (Westrich, 1990; Müller, 1996). Aliev (1986) also recorded *A. oblongatum* from species of *Carduus* and *Cichorium* (Asteraceae) in Azerbaidjan, Caucasus Minor.

At most U.S. collection sites, males and females of *A. oblongatum* were captured while visiting flowers of *Sedum spectabile* Boreau (Crassulaceae).

NEW EASTERN NORTH AMERICAN RECORDS FOR *A. MANICATUM*

The geographic range of *A. manicatum* in eastern North America is apparently expanding since original discovery of the species in central New York in 1963. By 1991, *A. manicatum* had been recorded from eastern Ontario (Smith, 1991), the first Canadian record for this immigrant bee. Examination of unidentified bees in the Cornell University Insect Collection (CUIC) and continuing survey work by ERH and AGW in eastern North America have yielded the following new locality records for *A. manicatum*: **CANADA: Ontario:** Niagara Falls, Niagara Parks Botanical Gardens, School of Horticulture, 28 August 1996, 16 September 1997, ERH, patrolling flowers of black horehound, *Ballota nigra* L. and other mint spp. (Lamiaceae) (6, CUIC). **UNITED STATES: New York:** Erie Co., Tonawanda, 3 July 1992, ERH (1, CUIC). Monroe Co., Rochester, Highland Park, 16 September 1997, ERH, ex *Salvia farinacea* Benth. (6, CUIC). Onondaga Co., Syracuse, 8 July 1979, M. H. Evans (1, CUIC). Ontario Co., Canandaigua, 16 September 1997, ERH, ex *Salvia farinacea* (3, CUIC); Geneva, 16 September 1997, ERH, ex *Antirrhinum* sp. (3, CUIC). **Pennsylvania:** Cumberland Co., Carlisle, Dickinson College, 25–

28 August, 1–2 September 1997, J. K. Long, Jr., ex *Salvia farinacea* cv. Victoria (3, CUIC; 7, PDA); Mechanicsburg, 18 August 1990, J. K. Long, Jr. (1, CUIC; 1, PDA). **Dauphin Co., Harrisburg,** Dept. Agriculture building, 7 August 1996, AGW (in association with *A. oblongatum*) (2, CUIC). Specimens are deposited in the CUIC and PDA, as indicated.

LITERATURE CITED

- Aliev, H. A. 1986. On the fauna of the bee genus *Anthidium* Fabr. of the Azerbaidjan SSR, Caucasus. Spixiana 9: 271–274.
- Hurd, P. D., Jr. 1979. Family Megachilidae. Pp. 1981–2081, in K. V. Krombein, P. D. Hurd, Jr., D. R. Smith, and B. D. Burks (eds.), *Catalog of Hymenoptera in America North of Mexico*. Volume 2: Apocrita (Aculeata). Smithsonian Institution Press, Washington, D.C.
- Jaycox, E. R. 1967. An adventive *Anthidium* in New York state (Hymenoptera: Megachilidae). Journal of the Kansas Entomological Society 40: 124–126.
- Lieftinck, M. A. 1958. Entomological results of the Finnish expedition to the Canary Islands 1947–1951. No. 16. A preliminary account of the bees of the Canary Islands (Hym., Apoidea). Commentationes Biologicae. Societas Scientiarum Fennica 18: 1–34.
- Michener, C. D. 1948. The generic classification of the anthidiine bees. American Museum Novitates No. 1381: 1–29.
- Michener, C. D. and T. L. Griswold. 1994. The classification of Old World Anthidiini (Hymenoptera, Megachilidae). University of Kansas Science Bulletin 55(9): 299–327.
- Mitchell, T. B. 1962. Bees of the Eastern United States. Volume II. North Carolina Agricultural Experiment Station, Technical Bulletin No. 152. 557 pp.
- Moure, J. S. and D. Urban. 1964. Revisão das espécies Brasileiras do gênero *Anthidium* Fabricius, 1804. Anais II Congresso Latino-Americano de Zoologia (S. Paulo, 1962) 1: 93–114.
- Müller, A. 1996. Host-plant specialization in western Palearctic anthidiine bees (Hymenoptera: Apoidea: Megachilidae). Ecological Monographs 66(2): 235–257.
- Pasteels, J. J. 1969. La systématique générique et subgénérique des Anthidiinae (Hymenoptera, Apoidea, Megachilidae) de l'ancien monde. Mémoires de la Société Royale d'Entomologie de Belgique 31: 1–148.
- Pechuman, L. L. 1967. Observations of the behavior of the bee *Anthidium manicatum* (L.). Journal of the New York Entomological Society 75: 68–73.
- Schrottiky, C. 1901. Biologische Notizen solitärer Bienen von S. Paulo (Brasilien). Allgemeine Zeitschrift für Entomologie 6: 209–216.
- Severinghaus, L. L., B. H. Kurtak, and G. C. Eickwort. 1981. The reproductive behavior of *Anthidium manicatum* (Hymenoptera: Megachilidae) and the significance of size for territorial males. Behavioral Ecology and Sociobiology 9: 51–58.
- Smith, I. P. 1991. *Anthidium manicatum* (Hymenoptera: Megachilidae), an interesting new Canadian record. Proceedings of the Entomological Society of Ontario 122: 105–108.
- Warncke, K. 1980. Die Bienengattung *Anthidium* Fabricius, 1804, in der Westpaläarkt und in turkestanischen Becken. Entomofauna 13: 341–376.
- Westrich, P. 1990. Die Wildbienen Baden-Württembergs. Spezieller Teil: Die Gattungen und Arten. Verlag Eugen Ulmer. pp. 437–972.

Distribution and Ethology of *Ceramius damarinus* Turner (Hymenoptera: Vespidae: Masarinae) in Namibia

By

SARAH K. GESS¹

ABSTRACT *Ceramius damarinus* Turner is the only species of *Ceramius* so far recorded from Namibia. Little was known of its distribution and nothing had been recorded concerning its ethology. The present paper greatly expands and discusses its known distribution, records for the first time its mating behaviour, flowers visited and provision, nesting situation and nest structure.

C. damarinus is recorded from 17°52'S–25°24'S and 14°51'E–17°55'E, indicating an arid savanna distribution. Females collect water for nest construction from the water surface. Males patrol both pools of water and flowers. Matings were observed only on water. At the site where nesting was studied a wide variety of plants was in flower, but both females and males were visiting only *Sesuvium sesuvioides* (Fenzl) Verdc. (Aizoaceae), and pollen from provision obtained from a nest cell and a fully grown larva was solely from this species. However, at a very dry site, where there was no water and no nesting in progress, apparently recently emerged females and males were visiting flowers of Lamiaceae, and males in addition flowers of Aizoaceae, Moluginaceae, Zygophyllaceae and Acanthaceae, all apparently for nectar. Nesting is in horizontal ground. The nest consists of a vertical shaft surmounted by a short cylindrical turret and gives rise at its base to a whorl of short sloping lateral shafts each ending in an ovoid sloping cell. There is no "bulb" in the shaft and there is no construction of a mud-cell within the excavated cell.

Keywords: Nests; Forage plants; Water collection; Mating; Conopid.

INTRODUCTION

Ceramius damarinus, the only species of *Ceramius* recorded from Namibia, has been previously poorly known. The species was described by Turner (1935) from females and a male from Ongandjera and a male from Kamanyab, part of material collected by the staff of the South African Museum (Gess 1965). Recently this species was recorded flying abundantly on the road from Okaukuejo to Okondeka, 3.iv.1996, by D.W. and G.T.Gess (Gess et al. 1997). A sample of 12 females was taken. Since then 13 females from Khorixas and four females and one male from Okaukuejo collected by W. Pulawski have been submitted to F.W.Gess for determination.

Amongst the targets of fieldwork by F.W. and S.K.Gess in Namibia in March–April 1997 was clarification of the distribution of *C. damarinus* and investigation of its flower associations, water collecting, mating behaviour and the architecture of its nests

ACKNOWLEDGMENTS

The author would like to take the opportunity to express her gratitude to Byron Alexander for the interest which he took in her research.

Thanks are expressed to the following for much appreciated assistance: Coleen Mannheimer of the National Botanical Research Institute, National Herbarium of Namibia, Windhoek, for identifying some of the plant specimens and for confirming the author's identifications of others; The South African Foundation for Research Development for a grant for fieldwork and publication costs.

DISTRIBUTION

Previously recorded and new collection records of *C. damarinus* are listed in Table 1 under the vegetation types of Gess (1971) and biomes of Rutherford and Westfall (1986) as adapted by Lovegrove (1993) (Figs. 1 and 2). Previous records suggested a northern Namibian distribution: however, the new records of Gess and Gess show that *C. damarinus* probably occurs throughout the dry savanna and its desert margins, with a rainfall of 100–500 mm per annum, to at least as far south as 25°24'S wherever water and suitable forage flowers are available. This gives this species a known distribution spanning almost 8 degrees latitude and reduces the apparent gap between it and its sister species in *Ceramius* Group 4, *C. beyeri* Brauns, from a remarkable 10 degrees to 5 degrees (Fig. 2).

¹ Albany Museum, Somerset Street, Grahamstown, 6140 South Africa. E-mail: amsg@warthog.ru.ac.za; S.Gess@ru.ac.za

Table 1. Collection records of *Ceramius damarinus* Turner listed under the vegetation types of Gess (1971) (given by number and name, see also Fig. 1) and the biomes of Rutherford and Westfall (1986) as adapted by Lovegrove (1993).

Vegetation Type	Collection Record
5 - Mopane Savanna (falling within Nama Karoo and Savanna biomes)	<p>Ongandjera [17°52'S 15°59'E] (S.A.M. staff [Hesse], iii.1923)</p> <p>Kamanyab [19°35'S 14°51'E] (S.A.M. staff [Hesse], iii.1925)</p> <p>Etosha National Park: between Anderson Gate and Okaukuejo, 19°13'S 15°55'E (sight record, F.W. and S.K.Gess, 26.iii.1997)</p> <p>15 km west of Khorixas [20°26'S 14°54'E] (W. Pulawski, 4.iii.1990)</p> <p>15.5 km by road west of Khorixas, 20°26'S 14°54'E (F.W. and S.K.Gess, 1.iv.1997)</p> <p>23km by road from Khorixas to Uis, 20°31'S 14°56'E (F.W. and S.K.Gess, 1.iv.1997)</p>
10 - Saline desert with Dwarf Shrub Savanna Fringe (falling within Savanna Biome)	<p>Okaukuejo to Okondeka [19°10'S 15°54'E to 18°59'S 15°52'E] (D.W. and G.T.Gess, 3.iv.1996)</p> <p>Okaukuejo [19°10'S 15°54'E] (W. Pulawski, 6.iii.1990)</p> <p>Between Okaukuejo and Halali at 19°10'S 15°58'E, 19°07'S 16°07'E, 19°03'S 16°14'E, 19°02'S 16°16'E and 19°00'S 16°23'E (sight records, F.W.Gess and S.K.Gess, 26 and 27.iii.1997)</p>
4 - Semi-desert and Savanna Transition (Escarpment Zone) (falling within Nama Karoo Biome)	<p>12 km southwest of Usakos on the road to Swakopmund, 21°59'S 15°29'E (F.W. and S.K.Gess, 22.iii.1997)</p>
7 - Thornbush Savanna (falling within Savanna Biome)	<p>30 km south of Omaruru on the road to Karibib, 21°41'S 15°59'E (F.W. and S.K.Gess, 23 and 24.iii.1997)</p>
9 - Dwarf Shrub Savanna (falling within Nama Karoo Biome)	<p>Nomtsas, 24°25'S 16°51'E (F.W. and S.K.Gess, 18.iii.1997)</p> <p>43 km and 97 km south of Mariental on road to Keetmanshoop, 24°58'S 17°55'E and 25°24'S 17°54'E (F.W. and S.K.Gess, 3.iv.1997)</p>

ETHOLOGY

Nesting areas and sites: Two nesting areas of *C. damarinus* were located. The first was in Dwarf Shrub Savanna on the north bank of the upper reaches of the Fish River at Nomtsas. The nesting area borders the riverine bush, which is composed in the main of tall *Acacia karoo* Hayne (Fig. 7). The second was in Thornbush Savanna on the slope above a farm dam in the catchment of the Khan River, 30 km south of Omaruru beside the road to Karibib (Fig. 3).

The sites in which the nests were aggregated were bare or very sparsely vegetated. All the nests were excavated in horizontal ground. Most nests were situated in expanses of level to gently sloping ground, but a few at the Nomtsas

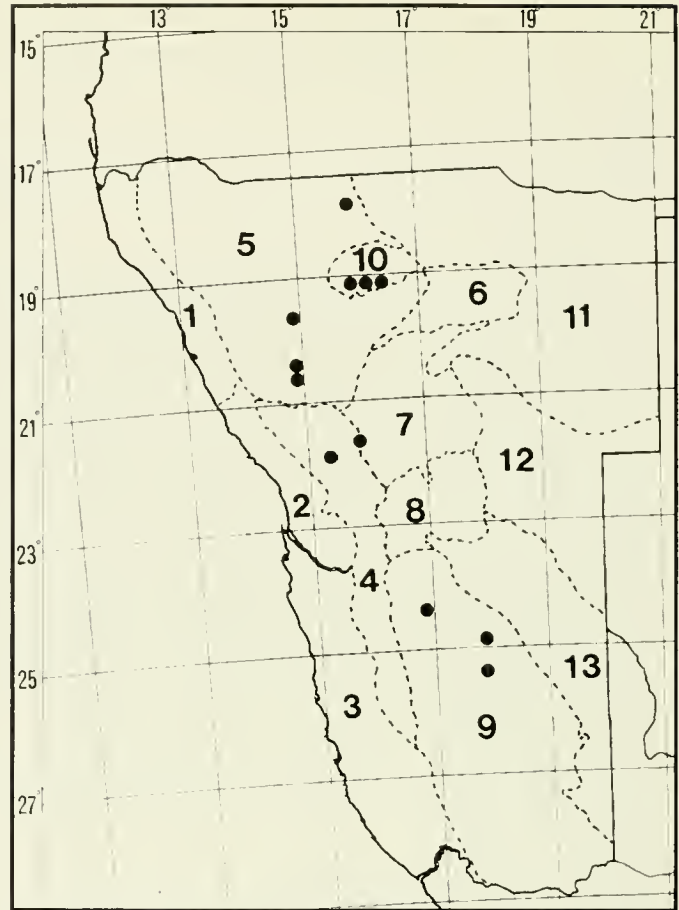

Fig. 1. Map of Namibia showing the distribution, based on collection records (Table 1), of *Ceramius damarinus* (dots) and the vegetation types of Gess (1971): 1 = Northern Namib; 2 = Central Namib; 3 = Southern Namib; 4 = Semi-desert and Savanna Transition (Escarpment Zone); 5 = Mopane Savanna; 6 = Mountain Savanna and Karstveld; 7 = Thornbush Savanna; 8 = Highland Savanna; 9 = Dwarf Shrub Savanna; 10 = Saline Desert with Dwarf Shrub Savanna Fringe; 11 = Tree Savanna and Woodland; 12 = Camelthorn Savanna (Central Kalahari); 13 = Mixed Tree and Shrub Savanna (Southern Kalahari).

nesting area had been excavated in level steps in water-cut banks of alluvial soil. At the second nesting area one of the aggregations was situated in a bare patch at the foot of a termitarianium of *Macrotermes mossambicus* (Hag.) (Fig. 11). In both areas the soil was sandy with sufficient clay to make it plastic when mixed with water. The soil at most sites was compacted to the degree that excavation of the nests required the use of a pick; however, some of the nests on banks on the fringes of the nesting area at Nomtsas were in weakly compacted alluvial soil.

Water collection: Water is required by females for nest construction. Water collection was observed at all sites except that between Khorixas and Uis, at which there was apparently no water. All water sources were pools in naturally occurring drainage channels (Figs. 3-6 and 8). Al-

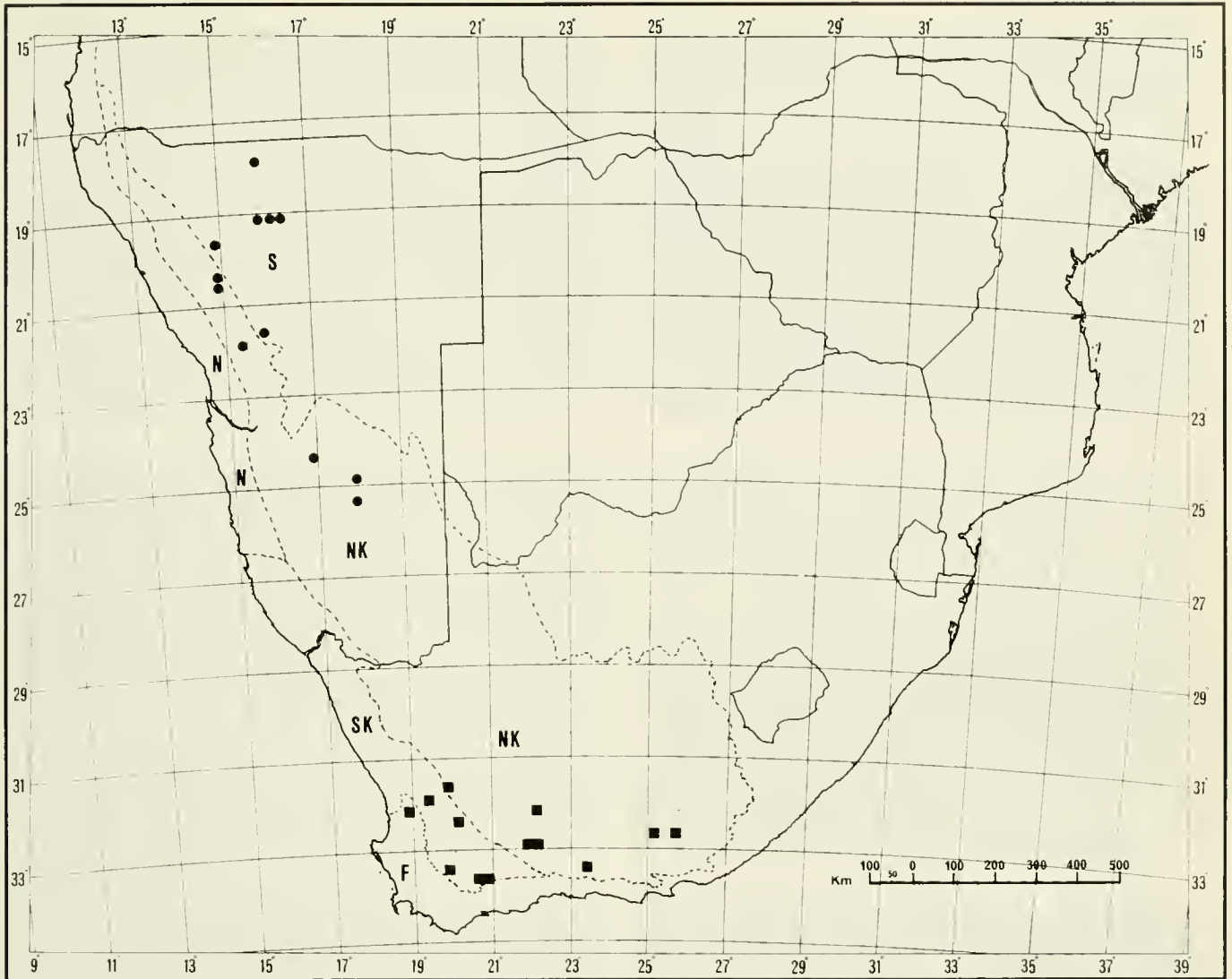

Fig. 2. Map of southern Africa showing the distributions, based on collecting records, of *Ceramius damarinus* (dots) and *Ceramius beyeri* (squares) (the two species of *Ceramius* Group 4) and the biomes of Rutherford and Westfall (1986) as adapted by Lovegrove (1993) (S = Savanna; N = Namib Desert; SK = Succulent Karoo; NK = Nama Karoo; and F = Fynbos).

though there is rapid run-off down drainage channels after rain, some of the water persists in "dams" formed as a result of naturally occurring rocks or depressions, as a result of artificial damming to provide water for stock or resulting from the construction of roads or railway lines. Only clean water was visited, never water contaminated by stock. A female when collecting water alights on the surface of the water.

Mating behaviour: Large numbers of males patrol to and fro over the surface of the water and over the forage plants. Numerous matings on water were observed. When a female alights on the surface one or more males alight on her. She either resists the male's advances and flies off or accepts him. If he is accepted, he grasps her and inserts his genitalia. Whilst such coupling is taking place the pair

usually momentarily lies together on the surface of the water (Fig. 13) before flying off together, the male above the female. In flight the male releases his hold on the female with his front legs but his genitalia remain engaged.

Flowers visited and nature of provision: The nature of the tongue suggests that in all flowers visited the nectar source must be readily accessible. It is short (tongue length: body length = 0.18 for females and 0.17 for males, the range for the females of 15 southern African species representing all 6 species groups being 0.18–0.36); the glossal lobes are unusually long relative to the total length of the glossa; and the paraglossae extend beyond the bifurcation of the glossa, whereas in the other southern African species groups they are very reduced.



Figs. 3-8. 3-Thornbush Savanna, thirty kilometres south of Omaruru ($21^{\circ}41'S$ $15^{\circ}59'E$), farm dam in the catchment of the Khan River. 4-Water sources of *Ceramius damarnius*, pools in an otherwise dry bed of a river in Mopane Savanna, 15.5 km by road west of Khorixas, $20^{\circ}26'S$ $14^{\circ}54'E$. Beyond the river banks the mopane trees are replaced with scattered low mopane bushes. 5-A water source of *Ceramius damarnius* in Mopane Savanna between Anderson Gate and Okaukuejo, $19^{\circ}13'S$ $15^{\circ}55'E$, in the Etosha National Park. 6-A water source of *Ceramius damarnius* on the edge of the saline desert of the pan, between Okaukuejo and Halali, Etosha National Park. 7-Bridge over the Fish River at Nomtsas ($24^{\circ}25'S$ $16^{\circ}51'E$), area of bare alluvial soil in the foreground, pool of water in the middle distance, tall *Acacia karoo* Hayne along the river banks in the distance. 8-The water source of nesting *Ceramius damarnius* at Nomtsas ($24^{\circ}25'S$ $16^{\circ}51'E$).



Figs. 9–14. 9–10. *Sesuvium sesuvioides* (Fenzl) Verdc. (Aizoaceae) at Nomtsas where it was apparently the only source of nectar and pollen utilized by *Ceramius damarinus*. 11–Termitarium of *Macrotermes mossambicus* (Hag.) in the bare area at the base of which was a nesting aggregation of *Ceramius*, 30 km south of Omaruru ($21^{\circ}41'S$ $15^{\circ}59'E$). 12–A nest turret of *Ceramius damarinus*, 30 km south of Omaruru ($21^{\circ}41'S$ $15^{\circ}59'E$). 13–Male and female of *Ceramius damarinus* in copula on the water surface. 14–A nest turret of *Ceramius damarinus* at Nomtsas ($24^{\circ}25'S$ $16^{\circ}51'E$).

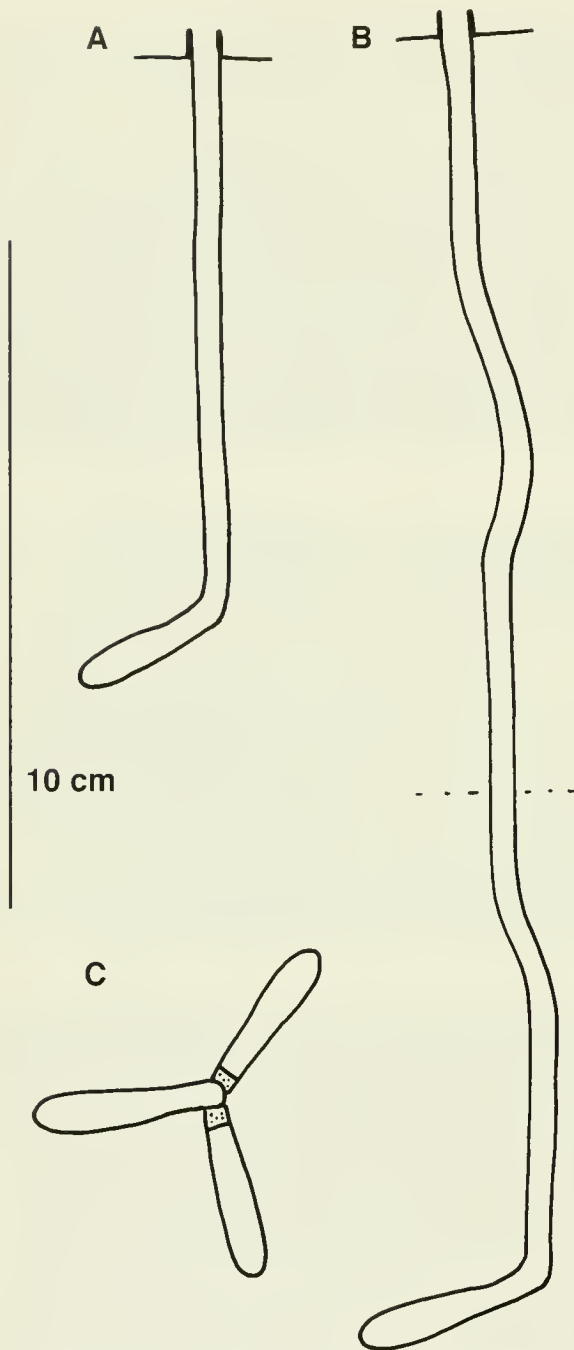

Fig. 15. Plans of two nests of *Ceramius damarinus*. A and B, vertical in a single plane. A—Nest in strongly compacted alluvial soil. B—Nest in strongly compacted alluvial soil overlain by loosely compacted alluvial soil. Dotted line indicates the level of soil change. C—Transverse plan, in a single plane at level of whorl of cells.

At Nomtsas large numbers of females and males were visiting flowers. Although there was a wide variety of plants in flower, the only flowers visited by both males and females of *C. damarinus* were the small, shallow, purplish-pink flowers of *Sesuvium sesuvioides* (Fenzl) Verdc.

(Aizoaceae) (Figs. 9 and 10).

Provision was present in only one of the nests investigated at Nomtsas. It consisted of a firm white mass with separate loads imparting a "segmented" appearance. The pollen from this provision and from the gut of a fully fed larva from another cell was examined microscopically. All the pollen matched that of the *S. sesuvioides* on which females were observed foraging. Individual pollen grains were 0.025 mm in diameter.

The only other site at which flower visiting was observed was that between Khorixas and Uis, the only site at which there was no water. At this site, a patch of mixed flowers growing on the banks of a dry drainage channel, only one plant of *S. sesuvioides* was located. This plant was being visited by *C. damarinus* (2 males); however, the flowers of five other families, *Limeum myosotis* H. Walter and *Gisekia africana* (Lour.) Kuntze (Moluginaceae) (formerly included in Aizoaceae) (2 males and 1 male), *Tribulus* sp. (Zygophyllaceae) (1 male), *Ocimum americanum* L. and *Leucas pechuelii* (Kuntze) Guerke (Lamiaceae) (11 males and 4 females, and 1 male, respectively) and a species of Acanthaceae (1 male) were also being visited. The predominance of males suggests that these wasps were recently emerged and that the flowers were most probably being visited for nectar. As nests were not found in this area and therefore nest provision was not obtained, it is not known which flowers would be visited for provisioning.

In the Etosha National Park, where large numbers of females and males were visiting water, none was seen to be visiting flowers; however, it was noted that only pools in close proximity to patches of pink-flowered Aizoaceae were favoured.

Sheltering and sleeping: Towards the end of the afternoon, activity at the water, on the forage plants and in the nesting area ceases. At Nomtsas both actively worked on, turreted nests and turretless, apparently old disused burrows were investigated in the late afternoon. Each turreted nest contained only a single female. One old nest burrow, lacking a turret, sheltered four males.

Nest guarding: No instances of nest guarding were observed. During the heat of the day, when foraging and water collection were in full swing, only actively nesting females were present at nesting sites. No males were present and therefore no guarding of nests by males, as has been recorded for *Ceramius bicolor* (Thunberg) (Gess and Gess, 1986), was taking place.

Nest: The nest (Fig. 15) consists of a sub-vertical burrow surmounted by a short (up to 7 mm high) cylindrical, vertical to sloping mud turret (Figs. 12, 14 and 15) with an inner diameter of 4 mm, equal to that of the shaft, and an outer diameter of 5 mm.

Most nests were in the initial stages of excavation, consisting of a turret and a sub-vertical shaft, but no cells. However, of eight turreted nests of 70 mm or more in depth three contained cells. At its maximum depth the main shaft curves outwards to end in a sloping cell 5 mm in diameter at its widest. Two of the nests contained one cell each and one three cells. Each cell terminates a short lateral shaft and all radiate out in a single whorl, that is, all at the same depth (Fig. 15). Nest depth varies considerably, the depths of the vertical shafts of the three nests with cells having been 85, 190 and 215 mm.

The walls of the excavated cells had clearly been stabilized, compacted and smoothed with the use of water.

Cell contents: The cell in one of the single-celled nests was newly constructed and empty, and that in the other contained only an egg. Of the cells in the three-celled nest one was open and contained an egg and provision, and the other two had been sealed and the lateral shafts filled with soil and sealed off from the vertical shaft. One of these sealed cells contained provision and a beetle larva, which had presumably devoured the wasp's egg or larva, and the other contained a fully fed *C. damarinus* larva.

Parasite: The dead, dry, brittle remains of a female *C. damarinus* were found in a nest which was clearly no longer being worked. The abdomen contained a foreign puparium from which a female conopid later emerged.

DISCUSSION

The construction of an entrance turret is common to all species of *Ceramius* for which nesting is known. The use of water as a bonding agent is furthermore common to all southern African species. However, the nests of *C. damarinus* are unlike those of the other five southern African *Ceramius* species groups in that the diameter of the vertical shaft is constant along its entire length, that is there is no portion widened to form a "bulb." Lack of a "bulb" has been recorded, however, for a palaeartic species, *C. tuberculifer* Saussure (Mauss, 1996).

The arrangement of the cells in a single whorl radiating out sub-horizontally from the base of the vertical shaft further distinguishes the nests from those of the other southern African species groups—the cells of groups 2 and 6 being grouped to one side of the shaft, those of Group 3 being positioned sub-vertically beneath the base of the vertical shaft, and those of groups 5 and 8 not being all at one level, with those of Group 5 in addition all being above the base of the shaft.

The cell resembles that of *Ceramius* Group 8, in that the walls are stabilized, compacted and smoothed with the use of water, and in the lack of a constructed earthen cell within the excavated cell. In this it differs from all the other southern African *Ceramius* and the palaeartic *C.*

tuberculifer, which do not smooth the walls of the excavated cell but do construct a mud cell within it (Gess, 1996; Mauss, 1996).

Gess (1996) constructed a key to the nests of *Ceramius* species groups 2, 3, 5, 6 and 8. By including Group 4 as represented by *C. damarinus*, this becomes a key to all the southern African species groups:

- | | | |
|---|---|---------|
| 1 | Excavated cells not containing constructed cells | 2 |
| — | Excavated cells containing constructed cells | 3 |
| 2 | "Bulb" present in vertical shaft | Group 8 |
| — | "Bulb" absent | Group 4 |
| 3 | No cell terminating main shaft | Group 5 |
| — | Cell terminating main shaft | 4 |
| 4 | Cells subvertical | Group 3 |
| — | Cells subhorizontal | 5 |
| 5 | "Bulb" short, bottom end well above level of cells .. | |
| | | Group 2 |
| — | "Bulb" long, bottom end level with cells | Group 6 |

Gess (1996) stated that pollen from provision obtained from 14 *Ceramius* species in southern Africa was for each species derived from a single plant family, which indicates that the genus *Ceramius* is markedly oligolectic and makes it possible to recognize clear associations. She furthermore demonstrated that all species in a group, or in the case of Group 2 a subgroup, specialize in a single plant family and that visits to flowers of more than one plant family, even for nectar, are infrequent. At the time the only flower visiting record for Group 4 was of *C. beyeri* visiting Aizoaceae. It was therefore predicted that *C. damarinus* would also specialize in Aizoaceae. The observations and the analysis of pollen from provision taken from nest cells at Nomtsas were supportive. That such a wide range of plant families were being visited at the site between Khorixas and Uis came as a disconcerting surprise! It is not known which of these plants would have been favoured for pollen collection as observations of the wasps on the flowers suggested that they were imbibing nectar and no nests were located at this site. As noted above only one plant of Aizoaceae was located at this site, so it could be that a shortage of the favoured forage plant resulted in opportunistic behaviour with regard at least to nectar collection. This would be in keeping with the records of *C. lichtensteinii* (Klug) which provisions with Aizoaceae, taking nectar from *Blepharis* (Acanthaceae) in Eastern Cape when the flowers of Aizoaceae are not available.

It is of interest that subsequent to the publication of Gess (1996) Mauss (1996) has recorded a wide range of forage plants for *C. tuberculifer* and has furthermore found that the cell provision of this species is of mixed plant fam-

ily provenance. This would indicate that, though in southern Africa species of *Ceramius* are markedly oligolectic and even when visiting flowers for nectar almost always visit the same flowers as they visit for pollen, marked oligolecty in *Ceramius* is not necessarily the rule.

Finally, of particular interest are the records of *C. damarinus* visiting Lamiaceae (=Labiatae). Gess (1996) noted that flowers of this family of plants, though favoured by some masarines in Europe, had not been recorded even as a casually visited nectar plant of any masarine in southern Africa. In this connection it is of interest that Mauss (1996) found *Teucrium* (Lamiaceae) a favoured forage plant of *C. tuberculifer*.

LITERATURE CITED

- Gess, F.W. 1965. Contributions to the knowledge of the South African species of the genus *Ceramius* Latreille (Hymenoptera: Masaridae). *Annals of the South African Museum* 48: 219–231.
- Gess, S.K. 1996. *The Pollen Wasps: ecology and natural history of the Masarinae*. Cambridge, Mass.: Harvard University Press.
- Gess, F.W. and Gess, S.K. 1986. Ethological notes on *Ceramius bicolor* (Thunberg), *C. clypeatus* Richards, *C. nigripennis* Saussure and *C. socius* Turner (Hymenoptera: Masaridae) in the Western Cape Province of South Africa. *Annals of the Cape Provincial Museums (Natural History)* 16: 161–178.
- Gess, S.K., Gess, F.W. and Gess, R.W. 1997. Update on the flower associations of southern African Masarinae with notes on the nesting of *Masarina strucki* Gess and *Celonites garipeensis* Gess (Hymenoptera: Vespidae: Masarinae). *Journal of Hymenoptera Research* 6: 75–91.
- Giess, W. 1971. A preliminary vegetation map of South West Africa. *Dinteria* 4: 1–114.
- Lovegrove, B. 1993. *The Living Deserts of Southern Africa*. Cape Town: Fernwood Press.
- Mauss, V. 1966. Contribution to the bionomics of *Ceramius tuberculifer* Saussure (Hymenoptera, Vespidae, Masarinae). *Journal of Hymenoptera Research* 5: 22–37.
- Rutherford, M.C. and Westfall, R.H. 1986. Biomes of Southern Africa—an objective categorization. *Memoirs of the Botanical Survey of South Africa* 54: 1–98.
- Turner, R.E. 1935. Notes on the masarid wasps of the genus *Ceramius*. *Annals and Magazine of Natural History* (10) 15: 290–299.

The Ultrastructure of the Wall and Lining Epithelium of Glandular Pouches in Nomadine Bees (Hymenoptera: Apidae: Nomadinae)

By

BRUCE CUTLER¹ AND BYRON A. ALEXANDER*

ABSTRACT The microstructure of the wall and lining epithelium of the female glandular pouches of two species of nomadine bees (*Nomada cressonii* and *Triepeolus distinctus*) was studied. The wall consists of an inner electron-lucent layer and a very thin electron-dense outer layer. The inside of the outer layer may exhibit thicker focal densities. Wall thickness varies from 0.1–2 μ m. The lining epithelium forms a monolayer of morphologically secretory cells, with vacuoles, endoplasmic reticulum and vesicles and with numerous villi at the apical border. One region showed fibrous material extending from the villi to the outer layer of the wall. The cells of *N. cressonii* presented a degenerate appearance which may suggest a senescence cycle for these cells.

Keywords: *Nomada*; *Triepeolus*; Transmission electron microscopy; Female reproductive system.

INTRODUCTION

The gross morphology of the female reproductive system of nomadine bees has been described and illustrated by Alexander (1996). These pouches were first described by Dufour (1841). Similar appearing but probably non-homologous structures are known in Ichneumonidae (Pampel, 1914; Robertson, 1968) and in Eurytomidae (James, 1926). In nomadine bees the pouches are fluid containing and vary greatly in size. In the two genera studied, *Nomada* and *Triepeolus*, the pouches are relatively large. Nomadine bees are cleptoparasitic on other bees. It has been suggested that the fluid may enhance egg survival by waterproofing and by inhibiting attack by soil microbes since the eggs are in direct soil contact. Another suggested function is that of chemical masking of the egg so that it is hidden from the host. However, the above hypotheses are purely conjectural and we do not have definitive studies delineating the function of the secretions of the pouches, see Alexander (1996) for a review of these topics.

Alexander (1996) referred to unpublished studies elucidating ultrastructural details of the lining epithelium of the glandular pouches. This paper illustrates and describes these features.

ACKNOWLEDGMENTS

I (B. C.) wish to dedicate this paper to my late colleague and co-author, Byron Alexander, a fine scientist and a wonderful field companion. I also wish to thank Robert Minckley, Auburn University, Alabama, for information and fruitful discussion.

MATERIALS AND METHODS

Female specimens of *Nomada cressonii* Robertson (Nomadini) and *Triepeolus distinctus* (Cresson) (Epeolini) were collected in Douglas Co., Kansas. The internal reproductive system was removed while the bees were immersed in 2.5% glutaraldehyde in 0.1 M, 7.3 pH cacodylate buffer at room temperature. The organs in fixative were placed in a refrigerator at 4°C. After 2–3 hours the original fixative was replaced by fresh fixative at 4°C. After about 40 hours the specimens were rinsed three times for 10 minutes each in the buffer without glutaraldehyde. Specimens were fixed again in 1% OsO₄ in the same buffer for 2 hours at 4°C. This was followed by two rinses in buffer, 10 minutes each, and one 15 minute rinse each sequentially in 30%, 50% and 80% ethanol. Specimens were kept in 80% ethanol overnight at 4°C, then processed through higher graded ethanol solutions to acetone and ultimately to Embed 812 epoxy resin (Electron Microscopy Sciences); the resin was then baked overnight at 65°C. Sections were cut with a diamond knife and examined with a JEOL 1200 ExII transmission electron microscope.

RESULTS

Because of differences in detail, the ultrastructure of the pouch walls and epithelium will be described for each species separately. In both species the epithelium is a unicellular layer, and the wall is electron-lucent except at the outer extremity where it may exhibit focal densities.

¹ Electron Microscopy Laboratory and Department of Entomology, University of Kansas, Lawrence, KS 66045-2106.
E-mail: bcutler@alive.bio.ukans.edu

* Deceased

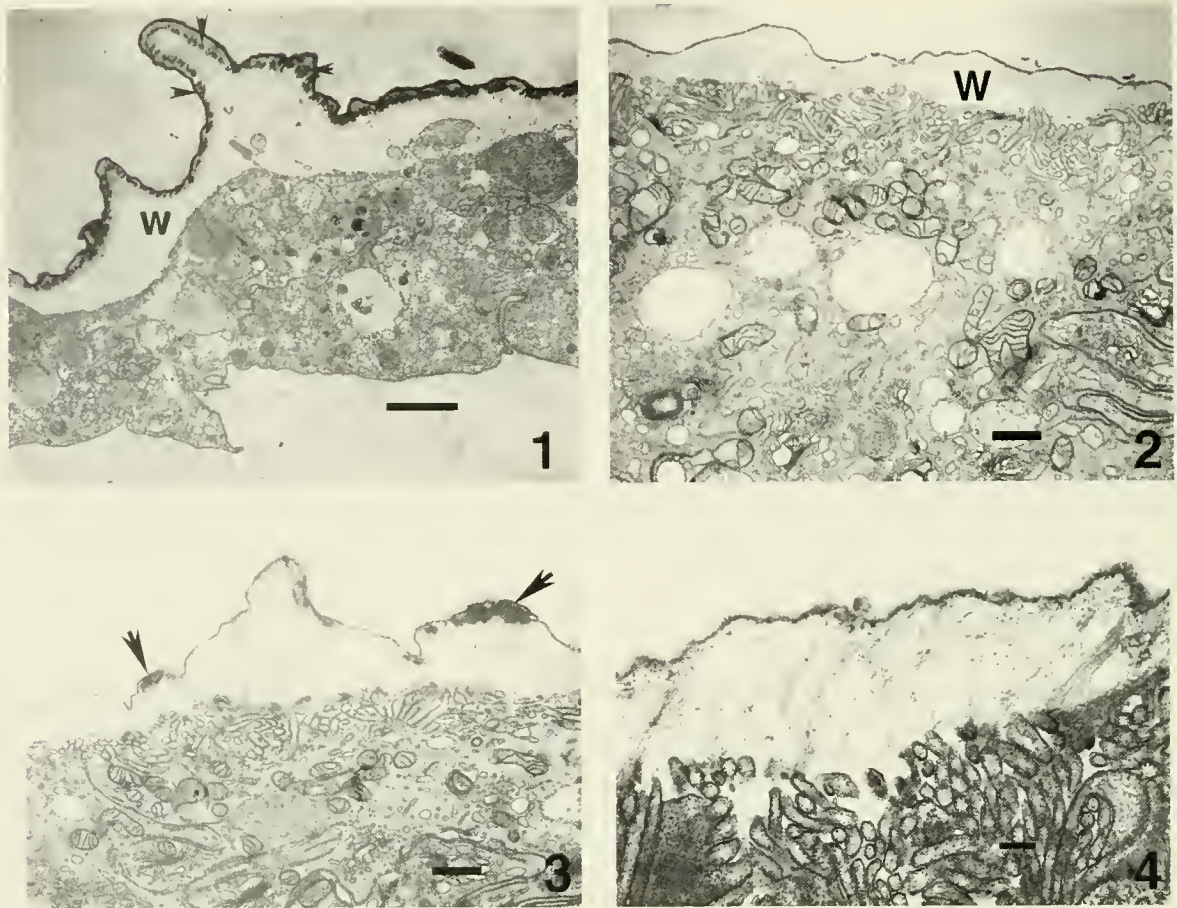

Figs. 1-4. 1-Pouch wall and lining epithelium of *Nomada cressonii*: W = wall; arrowheads = focal densities. Scale bar = 2 μm . 2-Pouch wall and adjoining epithelial region of *Triepeolus distinctus*: W = wall. Scale bar = 0.5 μm . 3-Pouch wall of *T. distinctus* showing focal densities (arrowheads). Scale bar = 0.5 μm . 4-Pouch wall of *T. distinctus* showing fibrils extending from epithelium to outer wall. Scale bar = 0.2 μm .

In *N. cressonii* the wall varies from about 0.5–2 μm thick. Three layers can be discerned; the layer adjoining the cells is thickest and is electron-lucent. It is followed by a dense layer with focal denser areas. The outermost layer is very thin, a few tens of nanometers, and is the densest (Fig. 1). The cells exhibit distinct cell membranes, but nuclei are not apparent. The cytoplasm is highly vacuolated with large granular vesicles. The general appearance suggests cell degeneration (Fig. 1).

The pouch wall of *T. distinctus* is much thinner, ranging from about 0.1–1 μm in thickness. For most of its length in the sections examined it appears as an inner lucent layer and a denser outer layer about 50 nanometers thick (Fig. 2). In one small region focal densities on the inside of the outer layer, similar to those seen in *N. cressonii*, appear (Fig. 3). In another small region fine fibrils can be seen extending from the villi to the outer layer of the wall (Fig. 4). The epithelium exhibits distinct cell membranes, nuclei with dispersed chromatin, abundant vacuoles, a few large granular vesicles, abundant mitochondria, smooth endo-

plasmic reticulum, and an apical border with many convoluted villi (Fig. 5). Golgi complexes can be seen close to nuclei (Fig. 6). At a few places on the inner cell border, small muscle fibril bundles were noted (Fig. 7). The general appearance is that of a metabolically active cell layer.

DISCUSSION

Since these are the first ultrastructural observations of glandular pouch structure, no direct comparisons are possible. However, comparisons can be made to known secretory cells. As an example, in the numbers of mitochondria, nuclear appearance and intimate folding of the distal epithelial border, the pouch bears a resemblance to the cells of the anterior silk gland of *Bombyx mori* (Akai, 1984). Muscle bundles are found associated with secretory epithelium (e.g., Happ, 1984) in insects. Noirot and Quennedy (1974) classified insect epidermal gland cells based on predominantly morphological characters. The lining epithelial cells of the pouches bear closest resem-

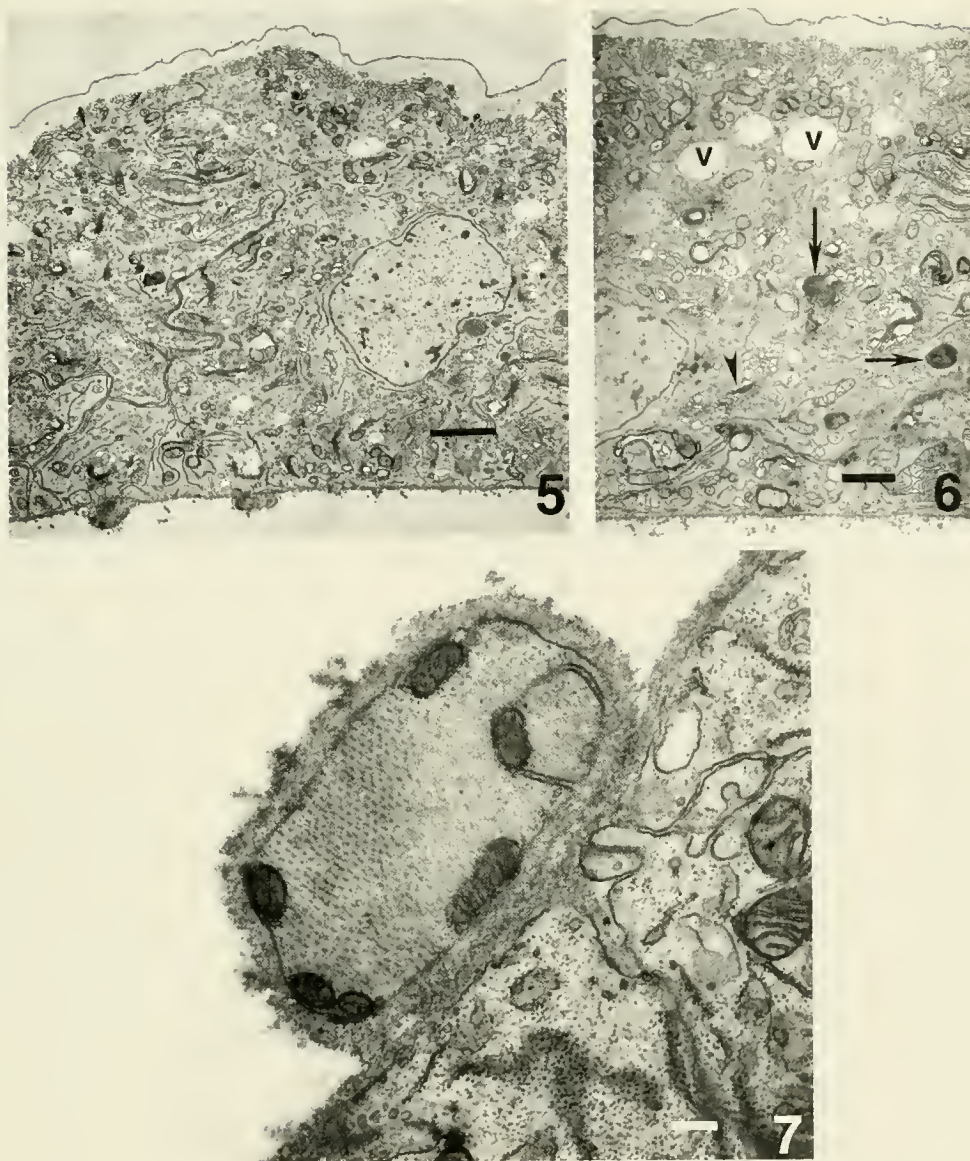

Figs. 5-7. 5-View of epithelium and pouch wall of *T. distinctus*. See text for details. Scale bar = 2 μm . 6-Golgi complex (arrowhead), vacuoles (v) and vesicles (arrows) in epithelium of *T. distinctus*. Scale bar = 1 μm . 7-Muscle fibril bundle adjoining inner layer of epithelium in *T. distinctus*. Scale bar = 0.2 μm .

blance to Noirot and Quenedeys' (1974) class I cells. These cells are the simplest type, a "thickening of the epidermis" with elaboration of apical microvilli, and numerous mitochondria, vacuoles and vesicles. It should be noted that Noirot and Quenedeys (1974) were discussing epidermis specifically, not epithelium in general. Because the origin of the lining epithelium is not known, it may be premature to attempt to fit it into a classification scheme for epidermal cells.

The fibrils extending from the tips of the villi (Fig. 4) to the outer wall imply that the epithelial cells are actively

involved in wall formation. Thus, there is circumstantial evidence for a secretory function for these cells.

The difference in the morphology between the two genera is difficult to explain. While in *Triepeolus* the epithelium shows well preserved organelles, many of those in the *Nomada* epithelium seem to be degenerate. It is possible that degeneration of these cells is a normal process. As the adult bee ages, the epithelium completes its functions and dies. Thus, the difference may be the result of the examined individuals of *Triepeolus* being younger than those of *Nomada*. The small number of specimens exam-

ined, two of each species, precludes any close examination of individual differences, but the morphology was consistent between the two specimens of each.

Alexander (1996) refers to the granular appearance of the pouch surface, attributing this to invaginations of the epithelial cell layer. Electron microscopic examination shows that the wall itself has greater relief than the underlying epithelium.

LITERATURE CITED

- Akai, H. 1984. The ultrastructure and functions of the silk gland cells of *Bombyx mori*. Pp. 323–364, in R. C. King, and H. Akai (eds.), *Insect Ultrastructure*. New York:Plenum.
- Alexander, B. A. 1996. Comparative morphology of the female reproductive system of nomadine bees (Hymenoptera:Apidae:Nomadine). *Memoirs of the Entomological Society of Washington* 17:14–35.
- Dufour, L. 1841. Recherches anatomiques et physiologiques sur les Orthoptères, les Hyménoptères et les Neuroptères. Académie des Sciences, Paris. Mémoires présentés par divers savants. Sciences Mathématiques et physiques. Series 2, Volume 7:265–647.
- Happ, G. M. 1984. Structure and development of male accessory glands in insects. Pp. 365–396, in R. C. King, and H. Akai (eds.), *Insect Ultrastructure*. New York:Plenum.
- James, H. C. 1926. The anatomy of a British phytophagous chalcidoid of the genus *Harmolita* (*Isosoma*). *Proceedings of the Zoological Society of London* 1926:75–182.
- Noiroi, C., and Quennedey, A. 1974. Fine structure of insect epidermal glands. *Annual Review of Entomology* 19:61–80.
- Pampel, W. 1914. Die weiblichen Geschlechtsorgane der Ichneumoniden. *Zeitschrift für Wissenschaftliche Zoologie* 108:290–357.
- Robertson, P. L. 1968. A morphological and functional study of the venom apparatus in representatives of some major groups of Hymenoptera. *Australian Journal of Zoology* 16:133–166.

Mating Behavior of *Dianthidium curvatum* (Hymenoptera: Megachilidae) at a Nest Aggregation

By

GAIL R. MICHENER¹ AND CHARLES D. MICHENER²

ABSTRACT Interactions between males and females of the megachilid bee *Dianthidium curvatum* Cockerell were observed during 152.4 h over 4 years at a nest aggregation in a sandy bank in southern Alberta, Canada. Both sexes appeared in late June or early July and disappeared in early to mid-September. Females commonly lived for >3 weeks, some for 7 weeks. Male-female contacts at the nest aggregation ranged from momentary to 201 s; when the numerous contacts of ≤ 5 s were excluded, average duration was 59.1 s ($n = 80$). Bees of both sexes mated multiple times. Males mated repeatedly, often within minutes and sometimes with the same female. Aged females and recently mated females remained attractive to males. Such behaviors suggest a reproductive advantage to the male that is the female's last mate before oviposition. Males did not preferentially seek contact with pollen-carrying females, but copulations tended to last longer with females carrying pollen than with females engaged in any other activity. Although the nest aggregation was a site at which females were located dependably, only a few males sought females there. The nest aggregation may not be the preferred encounter site for mating because the females most frequently encountered there are closing cells or constructing new cells, so are a day or more away from their next oviposition.

Key Words: *Dianthidium*; Longevity; Multiple mating; Sex ratio; Sexual interactions.

INTRODUCTION

Male bees do not search randomly for females, but instead concentrate their activity in locations where receptive females are most likely to be found. Eickwort and Ginsberg (1980) identified two classes of encounter sites: landmarks containing no food or nesting resources and resource-based sites containing flowers, nest material sources, or nest sites required by females. The distribution of such resources can influence the mate-locating behavior of males (Alcock, 1980; Eickwort and Ginsberg, 1980). When patchy resource distribution results in aggregation of females, territoriality by males is predicted, particularly if the number of competitors is low.

The frequency with which females mate in a lifetime is another factor that affects mate-locating behavior of male bees (Alcock et al., 1978; Alcock, 1980; Eickwort and Ginsberg, 1980). Single mating by females favors males that locate virgin females, either as they emerge from the natal nest or when seeking their first nectar meal, whereas multiple mating potentially favors the last male to mate before oviposition, especially if sperm displacement occurs. Males could locate polyandrous females shortly before they oviposit either by seeking females at pollen sources or by mating with returning foragers at the nest site. Although females of polyandrous species remain receptive, they may exercise choice among males. The greater complexity of the endophallus in polyandrous than monandrous species

of bees suggests that genital morphology is influenced by sexual selection (Roig-Alsina, 1993).

Females of the megachilid *Dianthidium curvatum sayi* Cockerell mate more than once (Custer and Hicks, 1927) and males have a complex multi-lobed endophallus with sclerotized and spiculated regions (Roig-Alsina, 1993). Females nest in aggregations to which they repeatedly return with resin, pebbles, and pollen to build and provision cells. Females gather pollen (and presumably nectar) from several genera of Compositae and resin from *Helianthus* (Custer and Hicks, 1927). *D. curvatum* copulates both on flowers and at nest aggregations (Custer and Hicks, 1927), but little is known about the role of the nest aggregation as an encounter site. We observed male-female interactions at such an aggregation to determine whether nest aggregations serve as principal encounter sites, whether males are territorial at nest aggregations, and whether males preferentially mate with females that are about to oviposit. Additionally, we report information on the occurrence of multiple mating and the duration of copulatory contacts.

ACKNOWLEDGMENTS

We thank Sarah Hughes, Stacey Barrett-Dowey, Alex Shearing, and Conley Chee for assistance in making observations. Manuscript preparation was facilitated by Virginia Ashlock.

¹ Department of Biological Sciences, University of Lethbridge, Lethbridge, Alberta, T1K 3M4, CANADA. E-mail: michener@uleth.ca

² Snow Entomological Collection, Division of Entomology, Natural History Museum, University of Kansas, Lawrence, Kansas, 66045.

NESTING SITE AND METHODS

From 1988 to 1992, we observed *D. curvatum sayi* nesting in an area of <1 m² in a vertical, bare, south-facing, sandy bank above the steep slopes that margin the north side of the Oldman River, 2 km south and 5 km east of Picture Butte, County of Lethbridge, Alberta, Canada (49°51'N, 112°42'W). Our site is located near the northern limit of the known range of the subspecies *sayi*, which extends south to Arizona and Texas. Numerous horizontal burrows of unknown origin in the sandy bank were used by female *D. curvatum* as nesting sites. Each year we inspected the site on or before 24 June, then revisited at 2- to 3-day intervals to establish the commencement of activity. In 1988 we initiated systematic observations 7 days after we found the nest aggregation, and in the subsequent 3 years we began observations as soon as 2-5 females were constructing cells. Approximate final dates of activity by bees were determined by visiting the site at 4- to 10-day intervals during September and early October.

We recorded the activity of females, the presence of males, and the occurrence of interactions between males and females at the nest aggregation during 152.4 h of observation over 4 years. We observed, usually for 60 min per day, on 34 days (30.2 h) from 1 July to 15 September 1988, on 19 days (18.4 h) from 29 June to 4 September 1989, on 9 days (12.3 h) from 8 July to 14 September 1990, and on 49 days (91.5 h) from 11 July to 15 September 1991. In all years, most observations were made in the early afternoon (1201-1500 h MDT; 56% of 152.4 h), with the remaining observations distributed between morning (19%) and late afternoon (25%). On 3 days (20-22 July) in 1991 we observed bees throughout the entire daily activity period (approximately 0900-1900 h MDT). In 1991 and 1996, we made a few additional observations at a larger aggregation in a similar sandy bank about 55 m away.

For each male-female interaction, we attempted to record the following: identity of the female (based either on a color mark painted on the thorax or on the nest entrance used); whether the female was approaching or leaving the nest aggregation; the stage in the female's nesting cycle (provisioning pollen or collecting nest materials such as resin and pebbles); the location of the pair during contact (female's nest entrance or elsewhere at the sand bank); the duration of physical contact (timed to the nearest second using a watch); and the subsequent behavior of the female (enter her nest or depart from the nest aggregation). Incidental records of male-female interactions, such as those occurring on flowers or at the nest aggregation outside the observation periods, were included in calculations of durations of contacts.

RESULTS

SEASONALITY AND LONGEVITY

Dianthidium curvatum in southern Alberta was active for about 10 weeks each year, typically from late June to mid-September (Table 1). Males of *D. curvatum* first appeared at about the same time as females, but usually disappeared in September a few days earlier than females. Numbers of females at the nest aggregation increased during July, reaching a maximum in late July-early August (Table 1). Females with unworn or little-worn wings were captured in each of the 3 years in which we inspected bees during early to mid-August, and we caught a female exhibiting only slight wing wear on 5 September 1988. Thus, emergence of females spanned ≥ 4 weeks. Limited information on wing wear of males indicated that males emerged until at least late July.

Based on recaptures of individually marked bees in 1991, females sometimes lived >5 weeks. For example, 8 females survived for 39-50 days (average = 44 days) and an additional 6 females had minimum lifespans of 22-34 days. Two males, one with slightly worn and the other with moderately worn wings on first capture, survived at least 9 and 13 days, respectively, after marking. In all years, the extent of wing wear of males generally fell within the range of wing wear of females captured on the same day suggesting that, if the wings of males wear at similar rates to those of females, males may live as long as females.

SIZE AND SEX RATIO

Males and females of *D. curvatum* were of similar size. For bees collected on flowers, mostly *Lygodesmia*, within 100 m of the nest aggregation in 1978, 1988, and 1994, mean \pm SD head widths were 3.18 ± 0.14 mm for 18 males and 3.11 ± 0.14 mm for 21 females ($t = 1.63$, $P > 0.10$).

Based on captures of bees arriving at the aggregation, females substantially outnumbered males (Table 2). Captures at another aggregation 55 m from our observation site further confirmed our impression that males were not numerous at nest aggregations (Table 2). However, the population sex ratio is not so strongly biased toward females as observations at the nest aggregation imply (Table 2). We collected 10 males and 8 females on flowers on 24 June 1988, and, from the small sample of cells we removed for rearing, 9 males and 3 females emerged.

THE NEST AGGREGATION AS A RESOURCE FOR MALES

To assess the value of the nest aggregation as a mating resource for males, we determined the number of females using the nest aggregation (Table 1) and the frequency with which they visited their burrows. Females almost always

Table 1. Active season of *D. curvatum* in southern Alberta.

	Year				
	1988	1989	1990	1991	1992
First sighting					
Female	24 June	27 June	29 June	8 July	26 June
Male	24 June	[2 July] ^a	[10 July] ^d	11 July	[11 July] ^a
Last sighting					
Female	15 Sept	4 Sept	14 Sept	15 Sept	3 Oct
Male	15 Sept	— ^b	5 Sept	2 Sept	19 Sept
Peak nesting activity ^c					
Date	25 July	28 July	30 July	5 Aug	—
N females	39	30	29	16	—
Nesting area (cm ²)	1350	800	875	600	—
Males at aggregation					
% ^d	59%	16%	25%	80%	—
(days)	(32)	(19)	(8)	(46)	—

^a Dates in brackets indicate an unconfirmed sighting.

^b No observations made 18 August to 3 September 1989; no males seen 4 September or thereafter.

^c Based on the observation date on which the maximum number of females was simultaneously preparing or provisioning cells and on the area of the minimum convex polygon encompassing the burrows used by these females.

^d Proportion of observation days before 5 September on which at least one male was observed at the nest aggregation.

returned to their nests at least once per hour, and commonly returned more frequently. For example, on the day for which we calculated peak density each year, most females (36 of 39, 19 of 30, 17 of 29, and 16 of 16) returned a minimum of 3 times per hour with material to construct or provision their cells. When closing cells, females collected pebbles below the sand bank with such rapidity that they often made scores of trips per hour. As examples, of 33 females active on 20 July 1988, 5 entered their nests 88, 64, 43, 36, and 33 times during the 60-min observation period, and of 30 bees active on 22 July 1989, 4 entered their nests 147, 72, 69, and 53 times in 60 min. Thus the nest aggregation was a site at which females could be located dependably.

Despite the availability of females at the nest aggregation, we captured males infrequently (Table 2) and, in some years, we saw males at the aggregation on $\leq 25\%$ of observation days (Table 1). Furthermore, we saw more than one male on only 7 of the 61 days on which we observed males at the aggregation.

Males were seen at the nest aggregation more frequently in late July and August, when the population of nesting females peaked, than earlier in the season. For example, in 1988, males were seen on only 2 of 11 days from 1 to 19 July but on all 15 days of observation from 20 July

Table 2. Numbers of males and females of *D. curvatum* captured at nest aggregations and reared from cells.

Locality	Date	No. of individuals	
		Males	Females
Captured at nest aggregation ^a			
Alberta			
Site 1 ^b	23 July 1990	0	14
	9 August 1990	1	14
	28 August 1990	3	8
	19 July 1991	1	13
Site 2 ^b	26 July 1991	1	8
	1 August 1996	0	11
Reared from collected cells			
Colorado (Hicks, 1926)		56	44
Kansas (Fischer, 1951)		18	37
Alberta (this study)		9	3

^a Only days on which we captured arriving bees without regard to sex are included.

^b Site 1 = aggregation observed annually 1988-1991; Site 2 = nearby aggregation inspected in 1991 and 1996.

to 19 August. In 1989, the only confirmed sightings of males at the nest aggregation occurred from 22 July to 11 August.

BEHAVIOR OF MALES

When at the nest aggregation, males usually faced the bank in hovering flight, moved around the entire nesting site and adjacent area, then departed. At times, one male appeared repeatedly each day for several days but rarely remained for >30 s on any visit. Such brief bouts of hovering at the nest aggregation were sometimes very frequent. For example, a marked male was seen 7 to 32 times per hour on each of 8 consecutive days 3-10 August 1991 for a total of 161 sightings, not including 34 contacts with females, in 7.9 h of observation. We have few data on the whereabouts of males when they were not at our study aggregation, but we know they sometimes visited other aggregations. For example, on 4 August 1991 the marked male was seen 5 m further along the sand bank where a few (<5) females nested in a minor aggregation. Another male caught and marked at our study aggregation in 1991 was not seen again until 9 days later when he was captured at another aggregation 55 m away on a different sand bank.

In the latter half of August 1991, one male spent prolonged periods at the nest aggregation either hovering or basking rather than making the brief visits that typified our other observations of males. During 60 min on 21 August, when 13 females were active, this male was noted

resting and basking 25 times, hovering 25 times, and pursuing or interacting with females 15 times. Frequent resting might indicate that the male was aged, but an alternate interpretation is that the male was protecting the site against conspecific males. The next day, we saw a chase, the only male-male interaction we witnessed during the study.

Despite many hours spent searching for bees at flowers and potential resin sources, we rarely observed copulations away from the nest aggregation; those we did see were on flowers. We detected no tendency for females of *D. curvatum* to congregate at sites other than vertical sand banks used for nesting or for males to congregate at any location.

INTERACTIONS BETWEEN MALES AND FEMALES

Male-female interactions occurred throughout the day, from as early as 0900 to as late as 1720 h MDT, and throughout the active season. The earliest date on which we observed sexual contact was 25 June 1988 and involved a female collecting pollen from *Lygodesmia*. At the nest aggregation, the earliest sexual contact was observed on 27 June 1988 and the latest on 5 September 1990. We detected no obvious differences between males and females in the times of day or weather conditions in which they were active.

At the nest aggregation, sexual contacts were initiated only by males. Males seemed to rely on visual rather than olfactory orientation to the female; they did not preferentially move upwind toward females, but tracked them visually regardless of wind direction. The efforts of males to grasp and copulate with females at the nest aggregation formed a continuous series connecting the following three categories: (a) the male chased a female in flight or attempted to pounce on a female, usually as she approached or entered her nest, but she eluded contact by flying away or by quickly entering her nest; sometimes the male followed the female into her nest burrow but emerged within a few seconds; (b) the male pounced and made brief physical contact with the female; (c) the male pounced, retained his grasp, and attempted to copulate.

Males of *D. curvatum* pounced on females from above. The male aligned his body with hers and he grasped the female with his legs, thus restraining her and sometimes holding her wings down. As described by Frohlich and Parker (1985) for *D. ulkei* (Cresson), the male's position was far back on the female, with his head above the posterior end of her thorax or base of her abdomen. He then quickly curved his curled abdomen over and behind the apex of the female's abdomen. The male's body pulsed spasmodically, without production of any sound audible to us, and the pair separated without warning. Because we were unable to determine when insemination occurred, we use

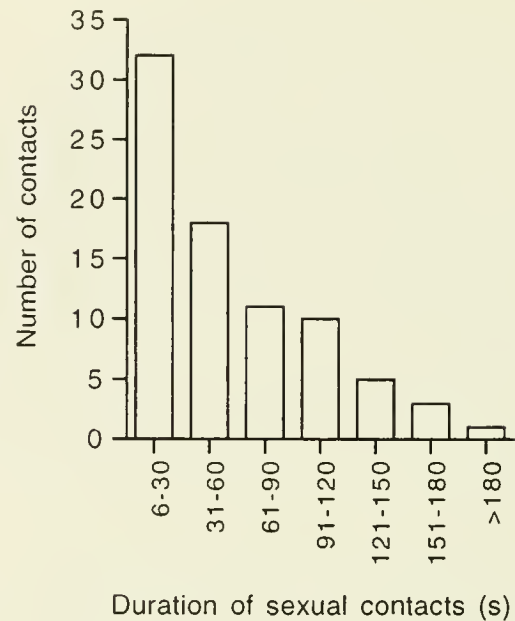

Fig. 1. Durations of sexual contacts for *D. curvatum*. Sample size = 80 contacts in which the male retained hold of the female for >5 s. Mean duration = 59.1 s.

the term "contact" to denote that the male made physical contact with the female without implying that insemination occurred.

The duration of male-female contacts at the nest aggregation was extremely variable, from <1 s to 201 s. Most physical contacts (148/247) were brief (≤ 5 s) and probably did not involve sperm transfer. Sometimes the female appeared to break away after 1-2 s but, in general, we were unable to determine whether contacts were brief because the female managed to escape before the male attained a firm grasp or because the male rejected the female. Of 99 contacts with durations of >5 s, we knew both initiation and termination times for 80 (Fig. 1). Although most of these timed contacts (63%) lasted ≤ 60 s, a substantial proportion (11%) lasted >120 s. Mean \pm SD duration of the 80 timed contacts was 59.1 ± 45.7 s.

Sexual contacts at the nest aggregation occurred predominantly at nest entrances to which females were returning or, less commonly, from which females were leaving. Of 183 sexual contacts for which we noted the female's location, 155 occurred at the female's nest entrance with an arriving female, 7 at the female's nest entrance with a departing female, 9 below the bank on a sandy patch where females collected pebbles and chaff, and 12 on the bank face. Arriving females seemed easier for males to grasp because they slowed down and maneuvered to alight at the nest entrance, whereas departing females typically burst out of their burrows and flew away rapidly, without

orientation flights. When a male grasped an arriving female, the contact usually occurred with the female partially in her burrow and the head of the male either in the entrance or against the sand bank above it. Females entered the burrow immediately after the pair separated or they made a brief flight of <60 s before entering the burrow; in no case did we see a female drop her load, whether resin, pebble, chaff, or pollen, when contacted by a male. If an arriving female evaded contact by flying off, she returned within a minute or two, still carrying her load. Departing females sometimes withdrew into their burrows and briefly delayed departure if a male was hovering nearby.

MATE PREFERENCES

Because we could usually identify the load carried by the female as she returned to her nest, we were able to assess whether males preferentially copulated with females that were provisioning cells with pollen, and therefore presumably shortly to lay an egg. We determined the availability of pollen-carrying females on the basis of return trips during 24 h of observation on 18 days between 25 July and 14 August, 1991. Pollen collection occurred throughout the day and females commonly required more than 1 day to provision a single cell; the nesting stages of different females within the aggregation were not synchronized. We considered each return trip by a female to be a potential opportunity for a male to pounce on the female as she maneuvered into her nest burrow. Most return trips involved females engaged in cell construction, not pollen collection; females returned carrying resin on 22.9%, pebbles or chaff on 47.5%, and pollen on 29.6% of trips ($n = 1647$ trips by 16 females on which the female's load could be identified). Of 68 approaches (11 chases, 13 attempted contacts, 18 contacts of ≤ 5 s, 26 contacts of > 5 s) by males to 15 of these females, the female was carrying resin on 41.2%, pebbles or chaff on 35.3%, and pollen on 23.5%, indicating that resin-carrying females were approached more often than expected given the frequency with which they arrived at the aggregation ($\chi^2 = 12.14$, $df = 2$, $P < 0.01$). When only contacts of > 5 s were considered ($n = 26$ contacts involving 13 females), the bias towards resin-carrying females was still apparent; females were carrying resin on 46.1%, pebbles or chaff on 30.8%, and pollen on 23.1% of such contacts ($\chi^2 = 7.84$, $df = 2$, $P < 0.02$).

Although pollen-carrying females were not approached preferentially by males, contacts of known duration ($n = 24$) tended to last longer (Mann-Whitney $U = 25$, $P = 0.05$) with females that were carrying pollen (mean \pm SD = 119 ± 68 s, range 19–201 s, $n = 6$ contacts involving 6 females) than with females returning with material for cell construction (58 ± 38 s, range 10–141 s, $n = 18$ contacts involving 9 females).

MULTIPLE MATING

Males of *D. curvatum* engaged in numerous sexual contacts, often rapidly switching from female to female and never guarding females. For example, during a 9-min period a marked male copulated for 124 s with one female (provisioning pollen), grabbed a second female (initiating a new cell) but lost contact when they fell from the bank face, chased a third female (collecting pebbles) as she entered her burrow and shortly thereafter retained contact with this female for 49 s, then attempted to pounce on the second female again. During 7.9 h of intense observation and 3.4 h of miscellaneous observation (while remarking bees) on 8 consecutive days 3–10 August 1991, this marked male made 21 long (> 5 s) contacts (average duration of 15 timed contacts = 66 s) with 11 females and 21 brief contacts (≤ 5 s) with 7 of these females and 3 other females. Thus, this male was known to have contacted 14 of the 16 females active at the site 3–10 August. On the last day he was identifiable, 16 August, the marked male engaged in a 30-s sexual contact, indicating that males can mate over at least a 2-week period.

Both previously mated and old females remained attractive to males. For example, a female was engaged in contacts of 82 and 31 s in a 10-min interval on 29 July 1991 (when she was 1 week old), a 201-s contact on 3 August, a 137-s contact on 13 August, and a 95-s contact on 16 August. Another female was involved in sexual contacts of 112 and 141 s with a marked male when she was 4 weeks old; 2 days later, she was contacted within an 11-min period by an unmarked male for 8 s, by the marked male for 30 s, and by the unmarked male again for 57 s. The oldest females we saw engaged in sexual contacts were 6 weeks old (a 10-s contact on 1 September 1991) and 7 weeks old (an 8-s contact on 25 August 1991). Durations of physical contacts showed no seasonal trend ($r = -0.13$, $P > 0.35$, $n = 52$ contacts of > 5 -s duration between 25 July and 1 September 1991), indicating that aging of bees did not significantly affect length of sexual contacts.

A potential cost to females of continued attractiveness to males is repeated interruption of cell preparation and provisioning. During observations made at the nest aggregation 25 July–14 August 1991 (see previous section), females returning with resin were twice as likely to be approached by males (7.4% of 377 resin trips) as females returning with other nest material (3.1% of 782 trips with pebbles or chaff) or with pollen (3.3% of 488 pollen trips). Of approaches that resulted in contacts of > 5 s, returning females were interrupted on 3.2% of resin trips, 1.0% of nest material trips, and 1.2% of pollen trips.

DISCUSSION

Females of *Dianthidium curvatum* mate more than once, so males presumably gain no reproductive advantage from finding virgin females. Males do not emerge noticeably earlier than females and, as with *Anthidiellum*, *Anthidium*, and *Callanthidium* (Alcock, 1977), males do not patrol nest aggregations from which virgins emerge. The tendency for males of *D. curvatum* to contact females repeatedly, even those with which they have recently copulated, indicates that males do not discriminate against recently mated females. If eggs are fertilized preferentially by sperm from the last copulation, as postulated for other anthidiines (e.g., Alcock et al., 1977; Alcock, 1980), every male should attempt to be the last one to mate with a female before she lays each of her eggs. A male could achieve this status by guarding the female until she lays her next egg, or he could increase his odds of being the last male by mating selectively with females that are provisioning cells rather than those that are closing completed cells or constructing new cells. We saw no tendency for males of *D. curvatum* to guard females at the nest aggregation or to make contact preferentially with females returning with pollen and therefore soon to lay an egg. Instead, males contacted females carrying resin more often than expected, perhaps because females with a large mass of resin in the mandibles were less agile and more easily grabbed and restrained by males. Given that 70% of incoming trips involved females engaged in nest construction, another option for a male to enhance his reproductive success would be to mate longer with those females that are most likely to oviposit soon, assuming that more sperm are transferred during longer copulations. Indeed, we found that copulations with pollen-carrying females tended to last longer than those with females engaged in other nesting activities. Because this pattern would also result if females were less resistant to mating when egg laying was imminent and because we could not ascertain which sex tended to terminate sexual contacts, we cannot assess whether the longer copulations with pollen-carrying females resulted from male choice or female choice.

At the nest aggregation, males of *D. curvatum* were more successful at pouncing on arriving than departing females. This pattern differs from the congener *D. heterulkei* Schwarz for which mating usually involves departing females (Clement, 1976). Females of *D. curvatum* were visible as they approached the nest aggregation, and they hesitated briefly as they maneuvered into their burrows; however, because of their aerial agility, females often evaded males. Females experienced sexual contacts of >5 s duration on <4% of return trips to the nest aggregation. Though such interruptions were short and infrequent, the evasive behavior of females and the brevity of most sexual con-

tacts suggest that females at the nest aggregation attempted to avoid copulations. Whereas females of most bee species are monandrous (Eickwort and Ginsberg, 1980), prolonged attractiveness to males in other species suggests that the costs of frequent interruption are either minimal or offset by some advantage from polyandry and multiple insemination.

Sexual contacts of *D. curvatum* last longer than those of *Anthidium* and some other *Dianthidium*, but are shorter than those of *Anthidiellum*. Average duration of copulations is <30 s for *Anthidium manicatum* (L.) (Severinghaus et al., 1981), *A. maculosum* Cresson (Alcock et al., 1977), and *A. septemspinatum* Lepeletier (Sugiura, 1991). Copulations are brief for *D. heterulkei* (16–32 s; Clement, 1976), somewhat longer for *D. ulkei* (0.5–3 min; Frohlich and Parker, 1985), and substantially longer for *Anthidiellum notatum* (Latreille) and *A. perplexum* Smith (average durations of 3.4 min and 2.9 min, respectively; Turrell, 1976). Custer and Hicks (1927) reported an average copulation time for *D. curvatum* of 59.7 s for 7 matings, virtually identical to the 59.1-s average duration we obtained for 80 sexual contacts.

Extrapolation from our observation that one male made 21 sexual contacts, with an average duration of 66 s per contact, in 11.3 h of observation suggests that males copulate hundreds of times during their lifetime. The pattern of numerous sexual contacts, sometimes with intervals of <10 min between consecutive contacts, raises the question of what proportion of sexual contacts by male *D. curvatum* result in sperm transfer. The complex endophallus of *D. curvatum* and other anthidiines probably represents an evolutionary adaptation of males to polyandrous mating by females, possibly as a result of intersexual selection by female choice or intrasexual selection by sperm competition (Roig-Alsina, 1993). Males may have been selected for an ability to transfer sperm whenever mating opportunities occur. However, the sperm supply at any time must be finite, so males might be expected to exercise some mate discrimination. Because males of *D. curvatum* seemingly pounced on any female they were able to approach, discrimination, if it occurred, took place after contacting the female.

Males of *D. curvatum* in southern Alberta encountered females both at flowers and at nest aggregations, but the nest aggregation did not serve as a principal encounter site for sexual interactions. Eickwort and Ginsberg (1980) proposed that territoriality should arise when encounter sites that reliably contain receptive females are localized and defensible. Territoriality and male-male aggression are pronounced in many anthidiines (Alcock et al., 1977; Jaycox, 1967; Severinghaus et al., 1981; Sugiura, 1991), including the congener *D. ulkei* (Frohlich and Parker, 1985),

but we saw only one possible instance of territorial defence by male *D. curvatum* at the nest aggregation. Because the nest aggregation was used as a mating resource by only a few males, we conclude that most males sought females elsewhere, presumably at flowers. Failure to use nest aggregations as principal encounter sites for mating also occurs in some other species of bees (Eickwort and Ginsberg 1980), implying that some advantage must accrue to males that locate females elsewhere than the nest aggregation. Although females can be dependably located at the nest aggregation, the area may not be a resource worth patrolling or defending because the females most frequently encountered there are closing cells or constructing new cells and are likely to copulate with other males before they next oviposit.

LITERATURE CITED

- Alcock, J. 1977. Patrolling and mating by males of *Callanthidium illustre*. *Southwestern Naturalist* 22: 554-557.
- Alcock, J. 1980. Natural selection and the mating systems of solitary bees. *American Scientist* 68: 146-153.
- Alcock, J., E. M. Barrows, G. Gordh, L. J. Hubbard, L. Kirkendall, D. W. Pyle, T. L. Ponder, and F. G. Zalom. 1978. The ecology and evolution of male reproductive behaviour in the bees and wasps. *Zoological Journal of the Linnean Society* 64: 293-325.
- Alcock, J., G. C. Eickwort, and K. R. Eickwort. 1977. The reproductive behavior of *Anthidium maculosum* (Hymenoptera: Megachilidae) and the evolutionary significance of multiple copulations by females. *Behavioral Ecology and Sociobiology* 2: 385-396.
- Clement, S. L. 1976. The biology of *Dianthidium heterulkei heterulkei* Schwarz, with a description of the larva (Hymenoptera: Megachilidae). *Wasmann Journal of Biology* 34: 9-22.
- Custer, C. P., and C. H. Hicks. 1927. Nesting habits of some anthidiine bees. *Biological Bulletin* 52: 258-277.
- Eickwort, G. C., and H. S. Ginsberg. 1980. Foraging and mating behavior in Apoidea. *Annual Review of Entomology* 25: 421-446.
- Fischer, R. L. 1951. Observations on the nesting habits of megachilid bees. *Journal of the Kansas Entomological Society* 24: 46-50.
- Frohlich, D. R., and F. D. Parker. 1985. Observations on the nest-building and reproductive behavior of a resin-gathering bee: *Dianthidium ulkei* (Hymenoptera: Megachilidae). *Annals of the Entomological Society of America* 78: 804-810.
- Hicks, C. H. 1926. Nesting habits and parasites of certain bees of Boulder County, Colorado. *University of Colorado Studies* 15: 217-252.
- Jaycox, E. R. 1967. Territorial behavior among males of *Anthidium banningense* (Hymenoptera: Megachilidae). *Journal of the Kansas Entomological Society* 40: 565-570.
- Roig-Alsina, A. 1993. The evolution of the apoid endophallus, its phylogenetic implications, and functional significance of the genital capsule (Hymenoptera, Apoidea). *Bollettino di Zoologia* 60: 169-183.
- Severinghaus, L. L., B. H. Kurtak, and G. C. Eickwort. 1981. The reproductive behavior of *Anthidium manicatum* (Hymenoptera: Megachilidae) and the significance of size for territorial males. *Behavioral Ecology and Sociobiology* 9: 51-58.
- Sugiura, N. 1991. Male territoriality and mating tactics in the wool-carder bee, *Anthidium septemspinosum* Lepeletier (Hymenoptera: Megachilidae). *Journal of Ethology* [Kyoto] 9: 95-103.
- Turrell, M. J. 1976. Observations on the mating behavior of *Anthidiellum notatum* and *Anthidiellum perplexum*. *Florida Entomologist* 59: 55-61.

Behavior and Subcaste Specialization Among Workers of the Giant Tropical Ant, *Paraponera clavata* (Hymenoptera: Formicidae: Ponerinae)

By

RODNEY S. HANLEY¹ AND JAMES P. LOVETT²

ABSTRACT This study addresses two questions regarding the natural history and behavior of *Paraponera clavata* (Fabricius), the giant tropical or Bala ant and the largest ant in Central America: (1) what are their foraging habits; and (2) are foraging workers specialized to particular food types? Our study was conducted at La Selva Biological Station, Costa Rica, in June 1996. Natural history observations and feeding trials of workers of *P. clavata* show that foraging workers are divided into two subcastes based on specialization to food types (fluid or prey). Additionally, we found that foragers are primarily nocturnal in their activity patterns, recruit to food sources, probably lay down individual pheromone trails, exhibit a curious falling behavior, produce stridulatory sounds, and exhibit the "social bucket" technique of fluid transfer.

Keywords: *Paraponera clavata*; Ponerinae; Formicidae; Behavior; Natural history; La Selva, Costa Rica; Feeding trials.

INTRODUCTION

Social insect colonies are composed of functionally different castes within groups of same-sex individuals. The social hymenopteran society consists of male and female reproductives and a worker class of sterile females. Workers may be differentiated, depending on species, into subcaste-groups of individuals that perform similar types of labor (Waddington, 1988). Individuals in each subcaste typically have similar morphology that distinguishes them from members of other castes (Wilson, 1953). Ants have the greatest worker differentiation among the Hymenoptera, with some species having two or three morphological subcastes (Oster & Wilson, 1978), although many ant species contain monomorphic workers.

Our study addresses two questions regarding the natural history and behavior of the giant tropical or Bala ant, *Paraponera clavata* (Fabricius). First, what are the foraging habits of these ants, including time of peak activity? It is well known that the temporal patterns of foraging frequencies in these ants can vary greatly (see McClusky & Brown, 1972; Hermann, 1973, 1975; Young & Hermann, 1980; Janzen & Carroll, 1983), and have been reported to be influenced by weather conditions (Baader, 1996). These studies highlighted several interesting features of the natural history of *P. clavata*; however, few details were provided.

Second, are foraging workers of *P. clavata* specialized to particular types of food items? Several authors (Hermann & Blum, 1966; Hermann & Douglas, 1976;

Janzen & Carroll, 1983) observed foraging workers returning to the nest carrying medium-sized dead insects. None of these observations indicates whether the ants are predators, scavengers, or both. Furthermore, workers are known to return to their nest frequently carrying a large drop of fluid (presumably nectar, honeydew, or sap) between their mandibles (personal observations; Young & Hermann, 1980; Bennett & Breed, 1985).

Breed & Harrison (1988) reported allometric "growth" among workers of *P. clavata* that correlated with task. Guards and foragers were significantly larger in overall size and smaller in ovary size than brood carriers and ants collected within the nests. However, Breed & Harrison (1988) treated foraging workers as one inclusive group and made no attempt to differentiate workers foraging for fluid or prey.

Paraponera clavata, the largest ant in Central America at approximately 20–35 mm in length, is dark reddish brown to black, with stiff bristly hairs and a solid build. This giant tropical ant prefers to nest at the base of large trees, especially *Pentaclethra macroloba*, and typical colonies are composed of 700–1000 individuals.

Recent studies have shown a considerable diversity in patterns of labor allocation in ponerine ants. Fresneau & Dupuy (1988), Fresneau et al. (1982), Pratt (1994), and Pratt et al. (1994) found that some ponerines exhibit temporal polyethism typical of species of higher subfamilies, while Traniello (1978) reported a complete lack of tempo-

¹ Snow Entomological Collection, Division of Entomology, Natural History Museum, University of Kansas, Lawrence, KS 66045. E-mail: rshanley@falcon.cc.ukans.edu.

² Department of Entomology, Haworth Hall, University of Kansas, Lawrence, KS 66045. E-mail: jlovett@falcon.cc.ukans.edu.

ral division of labor for *Amblyopone pallipes* (Haldeman). However, Lachaud et al. (1988) detected rough behavioral castes in *A. pallipes* similar to those reported in other ponerines.

ACKNOWLEDGMENTS

We thank Michael Greenfield and Charles D. Michener for their help during the course of this study, and Daphne Fautin and Richard A. B. Leschen for their critical reviews of this manuscript. This is contribution no. 3214 from the Division of Entomology, Natural History Museum, University of Kansas, Lawrence. We give special thanks to the late Dr. Byron Alexander whose encouragement and help made this study possible. We considered Byron as both mentor and friend. Byron will be missed.

MATERIALS AND METHODS

This study was conducted as part the University of Kansas, Department of Entomology Summer Field Course, from 30 May–16 June 1996, and was divided into two parts: (1) natural history observations, and (2) feeding trials. The study site was the Holdridge Arboretum at La Selva Biological Station of the Organization for Tropical Studies, Heredia Province, Costa Rica. A colony of *P. clavata* was observed at the base of a large canopy tree (*Protium panamense*, Family Burseraceae) from 8–13 June 1996.

Natural history information, including patterns of daily activity and types of food items, was obtained by observing the colony continuously over a 24 h period, and intermittently over the following 5 d. All ants leaving the colony were counted and their time of departure recorded. Returning foragers were lightly dusted with a fluorescent dye for identification purposes. Pink dye was used on those returning with prey items and orange was used for those with fluid. All ants returning with food items were counted and their time of return recorded. It was noted whether they had been previously dusted, and a variety of other natural history observations were recorded.

Trials were performed to test for specialization to food types among foraging workers. We attached feeding stations at a height of 2 m on the tree and observed them during peak activity times over 3 d, once in the morning and once in the afternoon. Each station consisted of one dish containing cotton soaked with maple syrup and another containing tuna fish or live termites. All ants foraging at the stations were dusted with a fluorescent dye depending on the food items being taken. Ants foraging at the stations were counted, and it was noted whether they had been previously dusted. Other natural history observations were recorded. Chi-square contingency analyses were used to examine these foraging data.

RESULTS

NATURAL HISTORY OBSERVATIONS

The observed colony of *Paraponera clavata* had two openings 10 cm apart at the base of the tree. These were approximately 6 cm × 2 cm, slightly raised, and connected by smooth-walled tunnels just below the soil surface.

Foraging workers of *P. clavata* were primarily nocturnal in their activity patterns, with little activity between 1000 and 1600 h (Fig. 1). Between 1500 and 1800 h (before dusk) a large number of foragers left the nest and disappeared into the canopy. Foraging occurred throughout the night with several peaks in returns and exits from the nest. The greatest mass return to the nest occurred between 0700 h and 0800 h. Workers exiting from or returning to the nest used one of two primary trails on the trunk of the tree. Foragers not using one of these trails would search up and around the tree to locate one of them. As returning workers approached the nest entrance (at approximately 2 m up the tree), they would accelerate until reaching the nest opening. Occasionally, workers were observed carrying dead ants and heavily sclerotized insect parts from the nest up into the canopy, presumably to a refuse site.

Ponerine ants have been reported to lay down individual pheromone trails (Hölldobler & Wilson, 1990), including *P. clavata* (Breed & Harrison, 1987; Breed et al., 1987). In our observations, workers would rarely follow one another in a line, but would remain restricted to what appeared to be primary trails. Workers appeared to move independently of each other while antennating the surface of the trails, often passing one another. During and after rain showers, workers appeared to have difficulty locating a primary trail on the trunk of the tree. The ants would initiate search behavior and, upon finding a trail, would quickly move in a more directed fashion. About 1 h after the rain showers ended, the ants once again moved "normally" along the trails. We interpret these behaviors as the ants utilizing pheromone trails in their movements; however, further work is needed for confirmation.

Perhaps the most curious behavior we observed was individuals falling out of the canopy onto the forest floor. We first suspected this behavior when we observed a few foragers approaching the nest on the ground; most ants traveled only up and down the tree. We then heard noises that sounded like small pellets hitting the leaf litter. We always found a worker ant on the ground in the vicinity of what we perceived to be the sound's origin. Many of these ants held struggling insects (usually other ants) in their mandibles; others held nothing. After hitting the forest floor, the ants would slowly navigate to the base of tree. Generally, they did not return directly to the nest entrance; rather, they traveled up and around the tree until

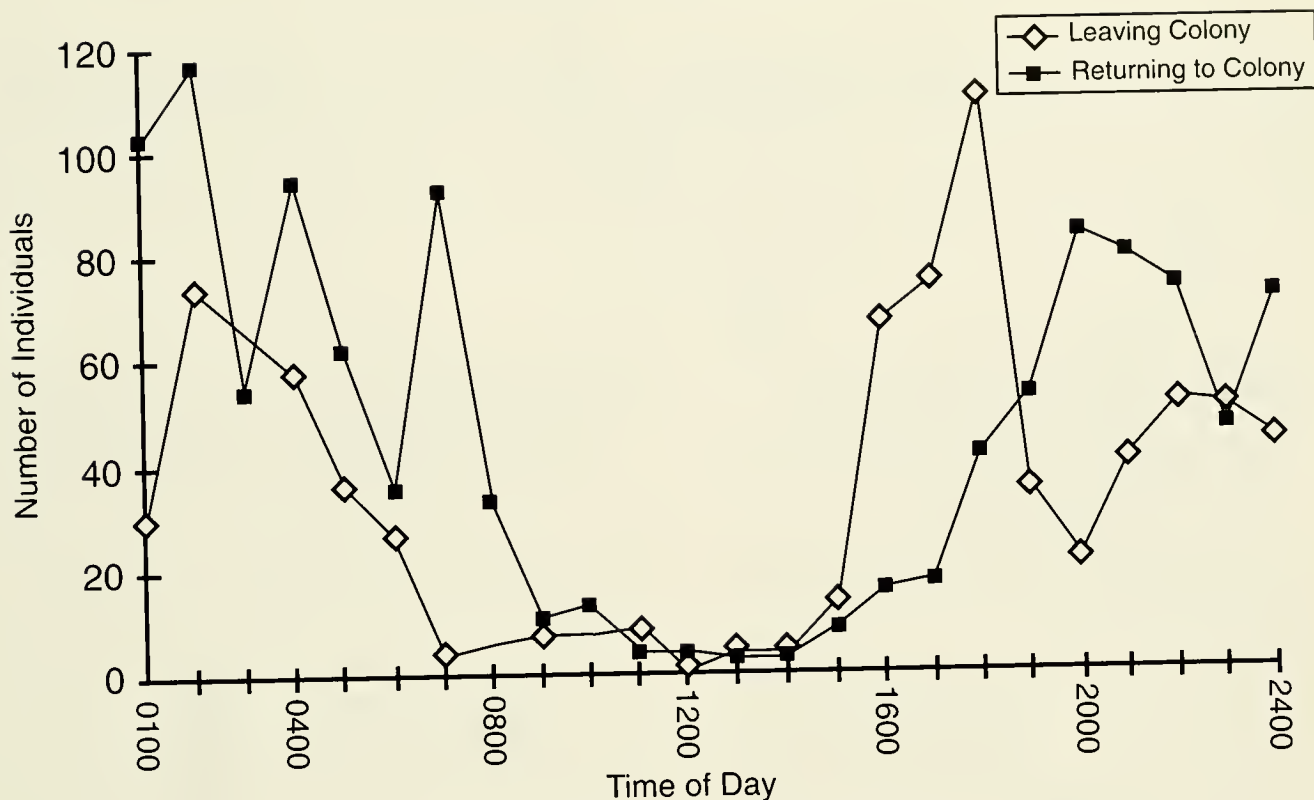

Fig. 1. 24 h activity pattern of *Paraponera clavata* colony.

they encountered one of the primary trails. They would then move down this trail into the nest.

This behavior has not been reported for other ponerine ants, and we observed no marked individuals performing this behavior. Perhaps this activity is performed exclusively by non-foraging workers such as guards or soldiers who were defending foraging columns and food sources. It is likely that this behavior relies on the use of visual landmarks as described by Baader (1996) for *P. clavata*.

We also heard foraging workers producing squeaking sounds upon disturbance. Direct physical contact elicited this response as well as merely passing a probe or hand over an individual. The function of this behavior is unknown—perhaps serving as a warning to potential predators or used as an alarm call to recruit assistance. These sounds were likely produced through stridulation of the file, located on the mid-dorsal region of abdominal segment IV, and the scraper, located on the posterior margin of abdominal tergite III as described by Giovannotti (1996).

Returning foragers were observed carrying one of two primary types of food in their mandibles: arthropod prey items such as termites, or fluid, presumably water or nectar. Most of the observed arthropod prey items were dead and chewed up, which made identification difficult. However, a significant portion appeared to be coleopteran and lepidopteran larvae, of which several were still alive.

Fluid foragers carried droplets suspended between their mandibles, which made these ants quite easy to recognize. Ants not only transported fluid droplets; they also transferred droplets to other individuals. Hölldobler & Wilson (1990) called this behavior the “social bucket” technique of liquid food transmission. We observed individuals with large fluid loads moving from side to side on the trunk of tree. Another forager would approach and wave its head up and down. The solicitor would rapidly antennate the head of the donor, and about half of the drop would be slowly transferred between the mandibles. After the transfer, both ants returned to the nest.

FORAGING SPECIALIZATIONS

To determine whether foragers of *P. clavata* are specialized on one type of food, we recorded what returning foragers were carrying and whether they had previously carried that type of food item. We did this over a 24 h observation period and during subsequent food-choice trials.

A returner was defined in our study as a marked ant that returned to the nest with a food item. A switcher was defined as an ant returning with a food item for which it was not originally marked. In those workers returning with fluid, only 3 switchers out of 148 returners occurred over a 24 h period (Fig. 2). In those workers returning with prey

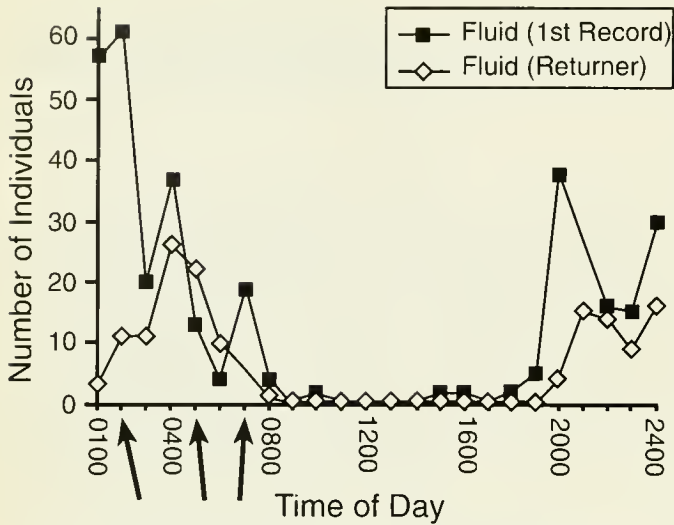

Fig. 2. Numbers of fluid foragers of *Paraponera clavata* entering the nest over a 24 h period ("switchers" indicated by arrows).

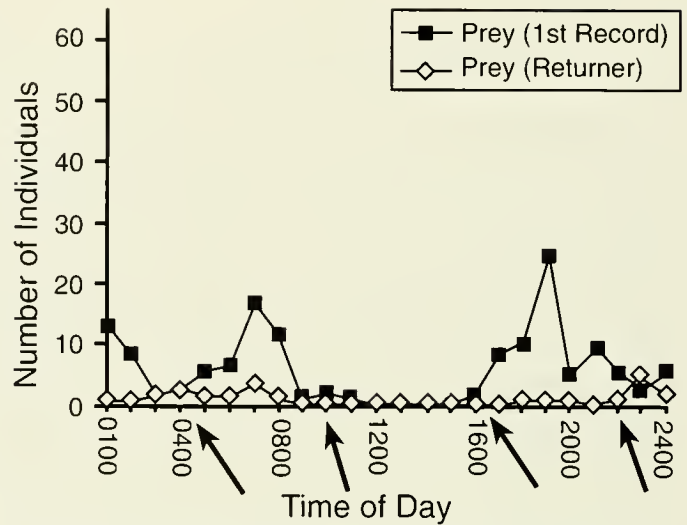

Fig. 3. Numbers of prey foragers of *Paraponera clavata* entering the nest over a 24 h period ("switchers" indicated by arrows).

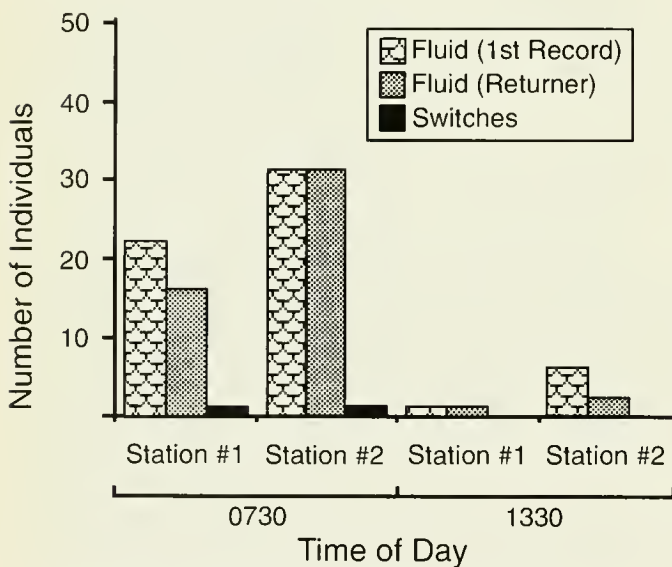

Fig. 4. Numbers of fluid foragers and "switchers" (fluid to prey) of *Paraponera clavata* at feeding stations.

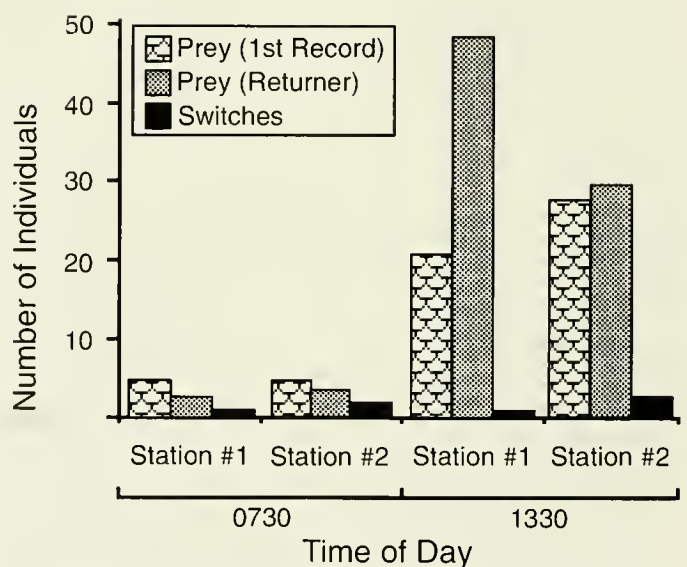

Fig. 5. Numbers of prey foragers and "switchers" (prey to fluid) of *Paraponera clavata* at feeding stations.

items, only 4 switchers out of 27 returners occurred over the 24 h period (Fig. 3). Overall, the number of fluid-carrying foragers entering the nest was much higher than the number of foragers returning with prey items.

During our food-preference trials, we further attempted to determine whether workers are specialized to prey items or fluid. Again, we recorded what returning foragers were carrying during each trial and whether they had previously carried that type of food item—either in the trial or during the natural history observations.

In those workers returning with fluid, only 2 switchers out of 50 returners occurred (Fig. 4). Fluid foraging was

considerably reduced during the 1330 h trial. In those workers returning with prey, only 7 switchers out of 86 returners occurred (Fig. 5). We observed some probing of the tuna fish by the ants, but very few pieces were returned to the nest. We then noticed the ants carrying tuna pieces up the tree into the canopy, just as they did with dead ants. We believe they treat tuna as garbage and deposit it in their refuse site. When we switched from tuna fish to live termites for the afternoon trial, the ants displayed a high level of recruitment, with a small number of workers initially foraging the termites and returning to the nest, and a large number of ants subsequently visiting the feeding station.

No termites were observed carried from the nest into the canopy as had been observed with the pieces of tuna.

Chi-square contingency analysis of the trial at 0730 h did not support forager specialization ($P > 0.5$). However, the results of the afternoon trial clearly illustrate specialization of foragers to one food type ($P < 0.001$).

DISCUSSION

Our natural history observations of *Paraponera clavata* confirm many observations made by previous authors. Our observations indicate that foragers of *P. clavata* are primarily nocturnal in their activity patterns with a discernable change in activities correlated with rain showers. It is well known, however, that the temporal patterns of foraging frequencies in these ants can vary greatly (see Hermann, 1975; Young & Hermann, 1980) and have been reported to be influenced by weather conditions (see Baader, 1996). In addition, our interpretation of the behavior of foragers of *P. clavata* is that they lay individual pheromone trails that are used by recruited ants to locate food resources. This behavior has been previously reported for *P. clavata* by Breed & Harrison (1987) and Breed et al. (1987), and our observations agree with their observations. Additionally, individuals of *P. clavata* are known to produce sound through stridulation (Janzen and Carroll, 1983; Giovannotti, 1996). In our observations, foragers of *P. clavata* produced squeaking sounds upon disturbance, which we interpret as a warning function of some kind; however, this conclusion remains to be confirmed. It has been well documented in the literature that foragers of *P. clavata* carry one of two types of food items in their mandibles: arthropod prey items and fluid, presumably nectar. Our observations indicate that foragers are active predators of other insects and utilize graded recruitment when a concentrated source of prey is found.

In addition to previously reported observations for *P. clavata*, we report for the first time additional natural history observations. Individuals of *P. clavata* were observed falling from the canopy onto the forest floor, typically holding struggling ants of other species. We interpret these individuals to be guards or soldiers likely defending foraging columns and food sources. In addition, foragers of *P. clavata* were observed to transfer fluid droplets to other foragers (i.e., the "social bucket" technique of fluid transfer). Presumably, the efficiency of colony provisioning is greatly enhanced through this behavior.

We have shown that foragers of *Paraponera clavata* are divided into subcastes based on their specialization to forage for either arthropod prey items or fluid. What we cannot answer at this time is whether these ants exhibit permanent subcaste specializations or whether these tasks are

some sort of temporal polyethism. Further replicating studies dealing with natural history of *P. clavata* would be quite useful in resolving this problem. Some evidence reported by other researchers on *Paraponera* indicates that these ants exhibit allometry associated with task (Breed & Harrison, 1988). If this hypothesis is further substantiated, then *Paraponera* may indeed exhibit permanent subcaste specializations.

LITERATURE CITED

- Baader, A. P. 1996. The significance of visual landmarks for navigation of the giant tropical ant, *Paraponera clavata* (Formicidae, Ponerinae). *Insectes Sociaux* 43: 435–450.
- Bennett, B. & M. D. Breed. 1985. On the association between *Pentaclethra macroleba* (Mimosaceae) and *Paraponera clavata* (Hymenoptera: Formicidae) colonies. *Biotropica* 17: 252–255.
- Breed, M. D. & J. M. Harrison. 1987. Individually discriminable recruitment trails in a ponerine ant. *Insectes Sociaux* 34: 222–226.
- Breed, M. D. & J. M. Harrison. 1988. Worker size, development and division of labor in the giant tropical ant, *Paraponera clavata* (Hymenoptera: Formicidae). *Journal of the Kansas Entomological Society* 61: 285–291.
- Breed, M. D., J. H. Fewell, A. J. Moore, & K. R. Williams. 1987. Graded recruitment in a ponerine ant. *Behavioral Ecology and Sociobiology* 20: 407–411.
- Fresneau, D. & P. Dupuy. 1988. A study of polyethism in a ponerine ant: *Neoponerinae apicalis* (Hymenoptera: Formicidae). *Animal Behavior* 36: 1389–1399.
- Fresneau, D., J. Garcia Perez, & P. Jaisson. 1982. Evolution of polyethism in ants: observational results and theories. Pp. 129–155, in P. Jaisson (ed.), *Social Insects of the Tropics. Vol. 1*. Paris: Presses de l'Université de Paris XIII.
- Giovannotti, M. 1996. The stridulatory organ of five ponerine species, a SEM study (Hymenoptera, Formicidae). *Fragmenta entomologica, Roma* 28: 157–165.
- Hermann, H. R. 1973. Formation of preforage aggregations in ponerine ants (Hymenoptera: Formicidae), a possible step toward group raiding. *Journal of the Georgia Entomological Society* 8: 185–186.
- Hermann, H. R. 1975. Crepuscular and nocturnal activities of *Paraponera clavata* (Hymenoptera: Formicidae: Ponerinae). *Entomological News* 86: 94–98.
- Hermann, H. R., & M. S. Blum. 1966. The morphology and histology of the hymenopterous poison apparatus. 1. *Paraponera clavata* (Formicidae). *Annals of the Entomological Society of America* 59: 397–407.
- Hermann, H. R., & M. Douglas. 1976. Sensory structure of the venom apparatus of a primitive ant species (Hymenoptera: Formicidae). *Annals of the Entomological Society of America* 69: 681–686.
- Hölldobler, B., & E. O. Wilson. 1990. *The Ants*. Cambridge, MA: Belknap Press/Harvard University Press. 732 pp.
- Janzen, D. H. & C. R. Carroll. 1983. *Paraponera clavata*. Pp. 752–753, in D. H. Janzen (ed.), *Costa Rican Natural History*. Chicago, IL: University of Chicago Press.
- Lachaud, J. P., D. Fresneau, & B. Corbara. 1988. Mise en évidence de sous-castes comportementales chez *Amblyopone pallipes*. *Actes des Colloques Insectes Sociaux* 4: 141–147.
- McCluskey, E. S., & W. L. Brown, Jr. 1972. Rhythms and other biology of the giant tropical ant *Paraponera*. *Psyche* 79: 335–347.
- Oster, G. F., & Wilson, E. O. 1978. *Caste and Ecology in the Social Insects*. Princeton, NJ: Princeton University Press. 352 pp.

- Pratt, S. C. 1994. Ecology and behavior of *Gnamptogenys horni* (Formicidae: Ponerinae). *Insectes Sociaux* 41: 255-262.
- Pratt, S. C., N. F. Carlin, & P. Calabi. 1994. Division of labor in *Ponera pennsylvannica* (Formicidae: Ponerinae). *Insectes Sociaux* 41: 43-61.
- Traniello, J. F. A. 1978. Caste in a primitive ant: absence of age polyethism in *Amblyopone*. *Science* 202: 770-772.
- Waddington, K. D. 1988. Body size, individual behavior, and social behavior in honey bees. Pp. 385-417, in R. L. Jeanne (ed.), *Interindividual Behavioral Variability in Social Insects*. Boulder, CO: Westview Press.
- Wilson, E. O. 1953. The origin and evolution of polymorphism in ants. *Quarterly Review of Biology* 28: 136-156.
- Young, A. M. & H. R. Hermann. 1980. Notes on foraging of the giant tropical ant *Paraponera clavata*. *Journal of the Kansas Entomological Society* 53: 35-55.

The Female of *Diadasia afflictula* Cockerell Unveiled and Verified Using Molecular Markers (Hymenoptera: Apidae)

By

SEDONIA D. SIPES¹

ABSTRACT I provide a description of the female of *Diadasia afflictula* Ckll., a species originally described from a male holotype, with which no female was previously associated. I describe characters and provide a key to distinguish *D. afflictula* females from morphologically similar congeners. To test the identity of the female *D. afflictula* independently from morphology, I sequenced 379 nucleotides of the mitochondrial gene Cytochrome Oxidase I in both a male and a female of *D. afflictula*, and in males and females of four morphologically similar species. The sequence data support the identity of the *D. afflictula* female, but raise questions concerning the identity of specimens previously determined to be *D. martialis* Timb. I discuss the use of molecular data to distinguish morphologically similar species and to associate sexes of the same species correctly.

Keywords: Solitary bee; Taxonomy; DNA sequence; Species identification.

INTRODUCTION

Diadasia Patton (Hymenoptera: Apidae) is a genus of about 55 species in arid regions of western North America and South America. Twenty-eight species of these solitary, mostly gregarious bees occur in western North America and Central America. *Diadasia* is particularly interesting not only because its members are putative floral specialists, but also because different species or groups of species use pollen from distantly related plant families (Linsley and MacSwain, 1957; Adlakha, 1969). Of the 28 North American species, most (16 spp.) specialize on members of the Malvaceae, one species each specializes on *Clarkia* (Onagraceae), *Convolvulus* (Convolvulaceae), and *Helianthus* (Asteraceae), and five species visit *Opuntia* (Cactaceae). Four species have been so rarely collected that insufficient floral records exist to characterize their host associations.

One species that has rarely been collected is *Diadasia afflictula* Ckll. This bee was described by Cockerell (1910) from a male holotype from Dona Ana Co., New Mexico, without associated female specimens. Timberlake (1941) included *D. afflictula* in his key to most North American *Diadasia* males, and Adlakha (1969) included it in his systematic revision of *Diadasia* north of Mexico, but still no female specimen had been associated with the males of this species. In August, 1997, I collected 5 male *D. afflictula* from Hidalgo Co., New Mexico, and 3 females which I determined to be *D. afflictula* based on their morphological similarities and geographic association with males, and their distinctiveness from females of other *Diadasia* species. Here I provide a description of the female of *D.*

afflictula and a key to separate females of this species from other *Diadasia* species. I also provide molecular evidence supporting the identification of these female specimens as *D. afflictula* and discuss the use of molecular data in species delineation within this genus.

Molecular and allozyme data have been used to aid in species identification and delineation in hymenopterans as well as other insects. Allozyme data have been used to differentiate closely related and cryptic species of bees (Scholl et al., 1990; Packer et al., 1992; Blanchetot and Packer, 1992; Carman and Packer, 1997), and DNA restriction fragment length polymorphisms (RFLPs) have been used to distinguish the morphologically similar European and African honeybee subspecies (e.g., McMichael and Hall, 1996). DNA sequence data have been used to taxonomically associate different generations of aphids that alternate between host plants (Stern et al., 1997; Aoki et al., 1997). I propose that similar techniques will be useful in species identification in bees in situations where one sex lacks distinguishing characteristics, or where the sexes of a species cannot otherwise be associated with confidence. Both situations are commonly encountered in the genus *Diadasia*.

ACKNOWLEDGMENTS

This paper is dedicated to Dr. Byron Alexander, who served briefly on my graduate committee, and with whom I had numerous insightful conversations about the ecology, evolution and systematics of *Diadasia*. Paul Wolf (USU), Terry Griswold (USDA/ARS), Carol von Dohlen (USU), and Vincent Tepedino (USDA/ARS) gave advice and suggestions. C. Michener, R. Brooks, B. Danforth, and J. Rozen provided locality information helpful in field col-

¹ Department of Biology, Utah State University, Logan, UT 84322-5305. E-mail: ssipes@biology.usu.edu

lections. Two reviewers gave suggestions which improved the manuscript. Financial support for this study was provided by the USDA/ARS Bee Biology and Systematics Laboratory, Logan, UT, by the USU Ecology Center, by the AMNH Theodore Roosevelt Memorial Fund, and by NSF Doctoral Dissertation Improvement Grant no. DEB-9701190.

METHODS

MORPHOLOGICAL DESCRIPTION

I examined three females that I collected and an additional 8 females found in undetermined material from the U.S. National Museum of Natural History. Body measurements for the morphological description of *D. afflictula* and comparison to other species were made following Adlakha (1969): Head width was measured at the outer orbits of the eyes in the middle of the face. Thorax width was measured between the outer edges of the tegulae. Forewing length was measured from the base of the wing to the apex. Measurements were made to the nearest 0.05 mm. To insure that my measurements were comparable to Adlakha's, I chose a sample of 10 females from the U.S. Pollinating Insect Collection, Logan, UT (USPIC), of *D. consociata* Timb. and *D. lutzi* Ckll. (species similar in size and coloration to *D. afflictula*) and made the following measurements: head width, thorax width, body length, forewing length. My measurements were all within the ranges reported by Adlakha. In particular, my means for head and thorax widths for these two species (measurements which I use to distinguish *D. afflictula* from several other species) were almost identical to Adlakha's. The metasomal tergites have been abbreviated T1, T2, etc.

MOLECULAR ANALYSIS

To test the association of male and female *D. afflictula* independently from morphology, I compared their DNA sequences from a fragment of the mitochondrial gene Cytochrome Oxidase subunit I (CO-I). This gene has been used to examine phylogenetic relationships of insects, including Hymenoptera, at various taxonomic levels (e.g., Downton and Austin, 1997; Pedersen, 1996; Stern et al., 1997). CO-I has a highly conserved amino acid sequence. I expected this gene to exhibit little intraspecific variation in *Diadasia* based on patterns observed in other insect taxa. No intraspecific variation was observed in 5 species of *Bombus* and 6 species of *Psithyrus* examined by Pedersen (1996), and less than 1% sequence divergence has been found within some species of aphids (Stern et al., 1997).

I chose one male and one female of *D. afflictula* for sequencing. Additionally, I chose one male and one female from each of four species morphologically similar to *D. afflictula*: *D. martialis* Timb., *D. lutzi*, *D. palmarum* Timb. and

Table 1. Primers used for PCR and sequencing. Locations are based on positions in *Apis mellifera* mitochondrial genome (Crozier and Crozier, 1993).

Designation	Sequence	Location (5'-3')
C1-J-1751 ^a (alias Ron)	5' ggatcacctgatatagcattccc 3'	2049 - 2071
C1-N-3661 ^a (alias Barbara)	5' ccacaaatttctgaacattgacca 3'	4213 - 4191
C1-N-2418-D ^b	5' atgaagtattaaaatttcgacaa 3'	2442 - 2419

^a Designed by Harrison et al. (see Simon et al., 1994).

^b Designed from *Diadasia*, *Ptilothrix*, and *Apis* sequences by S. Sipes.

D. consociata. An additional male *D. martialis* was later sequenced to further evaluate the unexpectedly high variation observed within this species. For comparison, I also sequenced one specimen of a morphologically dissimilar species, *D. enavata* Cr. All specimens had been preserved in 100% ethanol after field collection. I identified these specimens using Timberlake's (1941) and Adlakha's (1969) keys to the North American *Diadasia*, and Adlakha's descriptions and illustrations of male genitalia.

DNA was extracted from the thorax (excluding legs and wings) of each specimen, following standard protocols (Sambrook et al., 1989). Body parts not used in the laboratory analysis are accessioned and deposited in the collection of the USPIC (accession information available upon request). I used the polymerase chain reaction (PCR) to amplify CO-I, using primers C1-J-1751 (Ron) and C1-N-3661 (Barbara) (Harrison et al., reviewed in Simon et al., 1994) (Table 1). Amplifications were performed in 100 µl volumes using 50–100 ng of template DNA, 1.5 mM MgCl₂, 1× Biolase™ reaction buffer, 1.25 mM each dNTP, 0.25 mM each primer, and 5 units of Biolase™ *Taq* DNA polymerase. Thermocycle conditions were as follows: hot start at 94 °C for 5 minutes followed by addition of polymerase, denature at 94 °C for 1:30 minutes, anneal at 53 °C for 1:30 minutes, extension at 72 °C for 5 minutes, 30 cycles total, final extension at 72 °C for 10 minutes. The PCR products were purified using Wizard® PCR preps (Promega, Madison WI). The first 379 bases of the amplified fragment were sequenced directly using an ABI-373A DNA sequencer and the ABI Prism™ dye terminator cycle sequencing core kit. Sequences were obtained for both strands of the fragment, using the forward PCR primer (C1-J-1751) and the internal primer C1-N-2417-D (Table 1). Sequences are deposited in GenBank (consecutive accession numbers AF039090 through AF039101).

Sequences were aligned using Sequencher 3.0 and checked visually (the fragment sequenced is entirely protein coding, with no deletions or insertions among the taxa examined). I used the test version 4.0d59 of PAUP (written by David L. Swofford) to generate a matrix of pairwise genetic distances (total number of observed pairwise nucle-

otide differences), and to perform a UPGMA cluster analysis based on these genetic distances. I included a sequence from *Apis mellifera*, the honeybee (Crozier and Crozier, 1993; GenBank accession L06178) in the analysis for alignment and comparative purposes.

RESULTS

Diadasia afflictula Cockerell

D. afflictula Cockerell, 1910. Ann. Mag. Nat. Hist. London 5: 366. male.

Male described in detail in Adlakha (1969).

Female: body length 6.15 to 8.6 mm (mean = 7.82); head width 2.5 to 2.9 mm (mean 2.7); thorax width 2.4 to 2.8 mm (mean = 2.65); ratio head width to thorax width 0.98 to 1.06 (mean 1.02); forewing length 5.2 to 6.7 (mean 5.98); abdomen width 2.9 to 3.25 mm (mean 3.05); N = 11; integument dark brown to black (slightly reddish in one specimen); head with pale hairs; clypeus with coarse punctures separated by 2–3 puncture diameters; mid flagellomeres of antenna wider than long; inner orbits of eyes divergent above.

Thorax covered with pale hairs; scutum finely punctured, slightly shiny between punctures; propodeal enclosure polished; tibial spurs not strongly hooked, only very slightly curved at apex; hairs of fore femur sparse and evenly distributed; hairs on ventral side of hind femur sparse, of variable lengths, pale, branched; dorsal side of hind femur polished, nude; scopal hairs of tibia long, pale, branched.

Abdomen with hairs short and tightly appressed on all terga; T1 with pale hairs, appressed on entire dorsal face up to edge of anterior basin of tergite; T2 with some brown hairs on disk, often interspersed with pale hairs, and with pale hairs at very base; apical band of thick, pale hairs, usually slightly widened medially; T3, T4 with dark brown hairs on basal half and well defined, wide apical band of thick, pale hairs, usually widened medially; T5 with dark brown hair at base, band of white hairs on disk, apical hairs light brown to ochraceous.

SPECIES DELINEATION

Females of several North American *Diadasia* species possess distinctive characteristics that allow easy identification. These include *D. nigrifrons* Cr. (black pubescence and process on front femur), *D. bituberculata* Cr. (large size and dark scopa), *D. angusticeps* Timb. (inner eye orbits parallel rather than divergent), and *D. tuberculifrons* Timb. (large polished tubercles on frons). Females of the three North American species within the subgenus *Dasiapis* (*D. olivacea* Cr., *D. ochracea* Ckll., and *D. tropicalis* Ckll.) have a yellow spot at the base of the mandible, and rounded

meso- and metatarsal claws (Snelling, 1994). Based on morphology, three species groups can be recognized from the remaining North American *Diadasia* species; within these groups females of different species may be more difficult to distinguish. Females of all of the species known or suspected to use cactus pollen (*D. australis* Cr., *D. rinconis* Ckll., *D. opuntiae* Ckll., *D. piercei* Ckll., *D. friesei* Ckll., and *D. knabiana* Ckll.) share a combination of characters that separate them from females of other species; these include strongly hooked hind tibial spurs and unbranched hairs on the fore basitarsi. Of the remaining species, which include mostly Malvaceae specialists, two main groups can be recognized by color of pubescence: those whose females have only pale hairs on the metasomal tergites, and those with both pale and dark hairs. *D. afflictula* Cr. is within this latter group, which also includes *D. afflictiva*, *D. consociata*, *D. lutzi*, *D. martialis*, *D. nitidifrons* Ckll., and *D. palmarum*. The following discussion refers only to the females of species in this latter group.

Although *D. afflictula* overlaps somewhat in body length with *D. martialis*, *D. afflictiva*, *D. nitidifrons*, and *D. palmarum*, the widths of head and thorax of *D. afflictula* do not overlap with those of the latter species. *D. afflictula* differs from *D. afflictiva* in having pale scopal hairs; the latter has dark brown scopal hairs. *D. afflictula* differs from all these in having more appressed pubescence on the metasomal tergites, and in having a head width to thorax width ≥ 1 (< 0.9 in the other species). Additionally, in *D. afflictula*, the hairs of the fore femur are sparse and evenly distributed. In *D. afflictiva*, *D. consociata*, *D. lutzi*, *D. martialis*, *D. nitidifrons* and *D. palmarum*, the hairs of the fore femur form a dense brush basally. *D. nitidifrons* differs from *D. afflictula* as well as *D. afflictiva*, *D. lutzi*, *D. martialis*, and *D. palmarum* in having a dull rather than shiny propodeal enclosure.

D. afflictula is similar in size and hair coloration to *D. consociata* and (some) *D. lutzi*. Again, metasomal pubescence distinguishes *D. afflictula* from *D. lutzi*. *D. lutzi* has much sparser and less appressed hair on tergites than *D. afflictula*. Additionally, *D. afflictula* has a head width to thorax width ≥ 1 , while in *D. lutzi* this ratio is < 0.9 . This latter characteristic is useful in identifying worn specimens. *D. lutzi* appears more than once in both Timberlake's and Adlakha's keys; apparently, some individuals have only pale hairs on the tergites, and some have dark hairs.

D. consociata is similar to *D. afflictula* with respect to the head to thorax width ratio, but differs in two other characters: the mid tibial spurs are strongly hooked in *D. consociata* but not in *D. afflictula*. Additionally, in *D. consociata*, the frontal line below the median ocellus is a sharp groove flanked by slight but obvious convexities; this feature is lacking in *D. afflictula*. The integument of *D.*

consociata is often (but not always) reddish, as opposed to dark brown or black of most *Diadasia* species. The integument of *D. afflictula* is usually dark, but one specimen examined had slightly reddish integument. *D. consociata* has the propodeal enclosure shining to slightly dull; the propodeal enclosure of *D. afflictula* is always shining.

The areas in the U.S. where *D. afflictula* has been collected (Hidalgo and Dona Ana counties, NM) lie outside the known ranges of most of the six morphologically similar species just discussed. Of these, only *D. lutzii* occurs in southwestern New Mexico (Adlakha, 1969).

KEY

The following key distinguishes females of *D. afflictula* from the other females in the complex defined above and takes the place of couplets 20–23 in Timberlake's (1941) key to female *Diadasia* of North America. I have attempted to reduce this section's dependence on subtle and variable differences in color of metasomal pubescence. My modification can also be used with Adlakha's (1969) unpublished key to female *Diadasia* of North America, replacing couplets 21 to 25. I leave *D. lutzii* and *D. palmarum* unresolved in the final couplet because, in my experience, the characteristics used by both Adlakha and Timberlake to separate these two are not reliable. Additionally, the characteristics used to identify *D. martialis* are those reported by Timberlake and Adlakha; based on molecular data presented below, these characteristics need to be reevaluated. (Potential solutions to these and other problems of species delineation are discussed later.)

20

T1–T5 with strongly appressed hairs (hair on dorsal side of T1 appressed to edge of anterior basin); head as wide or wider than thorax (ratio of head width: thorax width usually ≥ 1.0 ; range 0.98–1.05); small bees (thorax width ≤ 3 mm)..... 21

Hair not strongly appressed dorsally at base of T1; head narrower than thorax (ratio of head width: thorax width < 0.9); bees of variable size 22

21

Mid tibial spurs strongly hooked; frontal line of head below median ocellus a sharp groove, flanked by convexities; fore femur with thick brush of hair basally *D. consociata* Timb.

Mid tibial spurs not hooked; head lacking both the sharp groove below median ocellus and flanking convexities; fore femur without basal hair brush; hairs sparse and evenly distributed on fore femur *D. afflictula* Ckll.

22

Propodeal enclosure dull; pubescence of thorax and metasoma rich ochraceous overall, except for brown hair at the bases of T3–T5 (and occasionally T2) *D. nitidifrons* Ckll.

Propodeal enclosure polished; pubescence of thorax and metasoma white to pale ochraceous, with dark brown hair at the bases of T2 to T5, or T3 to T5 23

23

T5 with predominantly dark hairs and only a few pale hairs interspersed; scopal hairs dark brown. *D. afflictula* Cr.

T5 with distinct fringe of white hairs on disk; scopal hairs pale (grey-brown in some *D. lutzii*, but still not as dark as in *D. afflictula*) 24

24

T2 with abundant dark hairs on basal half; T2–T4 with dark hairs basally, and with thick, well-defined apical bands of pale hairs, widened medially *D. martialis* Timb.

T2 with either pale hairs only, or with few brown hairs on disk, interspersed with pale hairs; T2–T4 with dark hairs basally, and with apical bands of pale hairs, not well defined, sometimes widened medially. *D. lutzii* Ckll. (in part) and *D. palmarum* Timb.

MOLECULAR ANALYSIS

Among the *Diadasia* individuals sequenced, 104 of the 379 nucleotides (27%) were variable. Of these 104 variable sites, 29% were at first codon positions, 10% were at second positions, and 61% were at third positions. Of the 126 amino acids encoded by this fragment, 34 varied among the *Diadasia* species examined.

The sequence data support the association of the *D. afflictula* male and female: the 379 nucleotides sequenced were identical in the male and female, and these two differed from the other morphologically similar species at 40 or more nucleotide positions (Table 2, Fig. 1). Similarly, *D. consociata*, *D. lutzii*, and *D. palmarum* exhibited much lower (or no) within-species variation than among-species variation. Two males of *D. martialis* had identical sequences, but differed significantly from a female of *D. martialis*. For example, the female of *D. martialis* differed from the males at 18 nucleotide positions, almost as much as this specimen differed from *D. consociata* (19 positions) (Table 2).

The morphologically dissimilar *D. enavata* differed from the other *Diadasia* examined by 51 to 63 positions, almost as much as *Apis mellifera* differed from *Diadasia* (65–77 positions). It is probable that *Apis* and *Diadasia* have diverged so much that third codon positions in this fragment have become saturated with substitutions.

Table 2. Matrix of pairwise absolute genetic distances (number of pairwise variable nucleotide positions) calculated from the 379 nucleotides sequenced from 12 individuals representing 6 species of *Diadasia* and *Apis mellifera* (m = male; f = female). Intraspecific distances are in bold face.

	1	2	3	4	5	6	7	8	9	10	11	12	13
1 <i>D. afflictula</i> (m)	—												
2 <i>D. afflictula</i> (f)	0	—											
3 <i>D. consociata</i> (f)	40	40	—										
4 <i>D. consociata</i> (m)	40	40	0	—									
5 <i>D. lutzi</i> (f)	51	51	26	26	—								
6 <i>D. lutzi</i> (m)	50	50	27	27	4	—							
7 <i>D. martialis</i> (f)	44	44	19	19	27	27	—						
8 <i>D. martialis</i> (m)	42	42	13	13	23	24	18	—					
9 <i>D. martialis</i> (m)	42	42	13	13	23	24	18	0	—				
10 <i>D. palmarum</i> (f)	47	47	39	39	45	45	44	37	37	—			
11 <i>D. palmarum</i> (m)	46	46	38	38	44	44	43	38	38	1	—		
12 <i>D. enavata</i>	56	56	60	60	63	61	58	61	61	52	51	—	
13 <i>A. mellifera</i>	67	67	65	65	66	67	66	63	63	76	75	77	—

DISCUSSION

BIOLOGY OF *D. AFFLICTULA*

Our knowledge of the geographic range of *D. afflictula* is incomplete. Specimens have been collected rarely in Hidalgo and Dona Ana counties in New Mexico; however, the species has also been reported in Mexico (Ayala et al., 1993), where it may be more common. Possibly its restricted occurrence in the extreme southern U.S. represents the northern limit of a more widespread distribution.

D. afflictula has been collected from *Malvella leprosa* (Ortega) Krapov. (= *Sida hederacea* (Hooker) A. Gray) and *Sphaeralcea* spp. Most of the 16 species of North American *Diadasia* that specialize on Malvaceae prefer *Sphaeralcea*, but at least one other species, *D. consociata*, uses *M. leprosa* as its primary pollen host (Linsley et al., 1952). It is not clear which of these two host taxa is most important to *D. afflictula*. Most of the specimens I examined were collected from *Sphaeralcea*, suggesting that it is the most commonly used host. However, collectors of bees are more likely to collect from *Sphaeralcea* (a colorful roadside wildflower) than from the very inconspicuous, low-growing *M. leprosa*. Thus it is possible that *D. afflictula* only occasionally visits *Sphaeralcea*, but that these floral records are over-represented in collections.

USE OF MOLECULAR CHARACTERS IN SPECIES DELINEATION IN *DIADASIA*

Males of *Diadasia* species usually possess distinguishing characters of the 6th and 7th sterna, and of the genitalia. However, females of some species are difficult to distinguish. There are three species groups for which determination of females is especially problematic: a group of large species that specialize on cactus (*D. australis*, *D.*

rinconis, *D. opuntiae*, *D. piercei*, and *D. friesei*), some of the small Malvaceae specialists in which females have pale hairs only on the metasomal tergites (*D. diminuta*, *D. vallicola* Timb., *D. mexicana* Timb., and *D. lutzi* (in part)), and the Malvaceae specialists with some dark hairs on metasomal tergites, discussed above. Keys currently used to identify females of *Diadasia* rely heavily on differences in the color and arrangement of pubescence (Timberlake, 1941; Adlakha, 1969). However, states for many of these characters vary within species and overlap among species. Moreover, these characters are easily lost as pubescence wears off during the life span of the bee.

To complicate matters further, species using the same host plants are often sympatric on a very small spatial scale. For example, males of at least 8 species of *Diadasia* have been collected from a single site in Mohave Co., AZ, from *Sphaeralcea* (Sipes, Tepedino, Griswold, unpublished) so geographic association with males may not provide any clues concerning the identity of females. Moreover, different species of *Diadasia* may nest in close proximity or in mixed aggregations (Eickwort et al., 1977; Neff et al., 1982; Ordway, 1984), calling into question even the association of individuals collected from nesting sites.

Molecular data provide an additional, independent means to solve (or at least gain insight into) species delineation problems. Here, I have used DNA sequence data to provide support to the identity of females of *D. afflictula*, for which no description has previously been published. The UPGMA phenogram also supports the correct association of both sexes of *D. consociata*, *D. lutzi*, and *D. palmarum*, but calls into question the identity of one or more of the specimens that I identified as *D. martialis*: the DNA sequence of the female I determined as *D. martialis* did not match that of *D. martialis* males nor that of any other

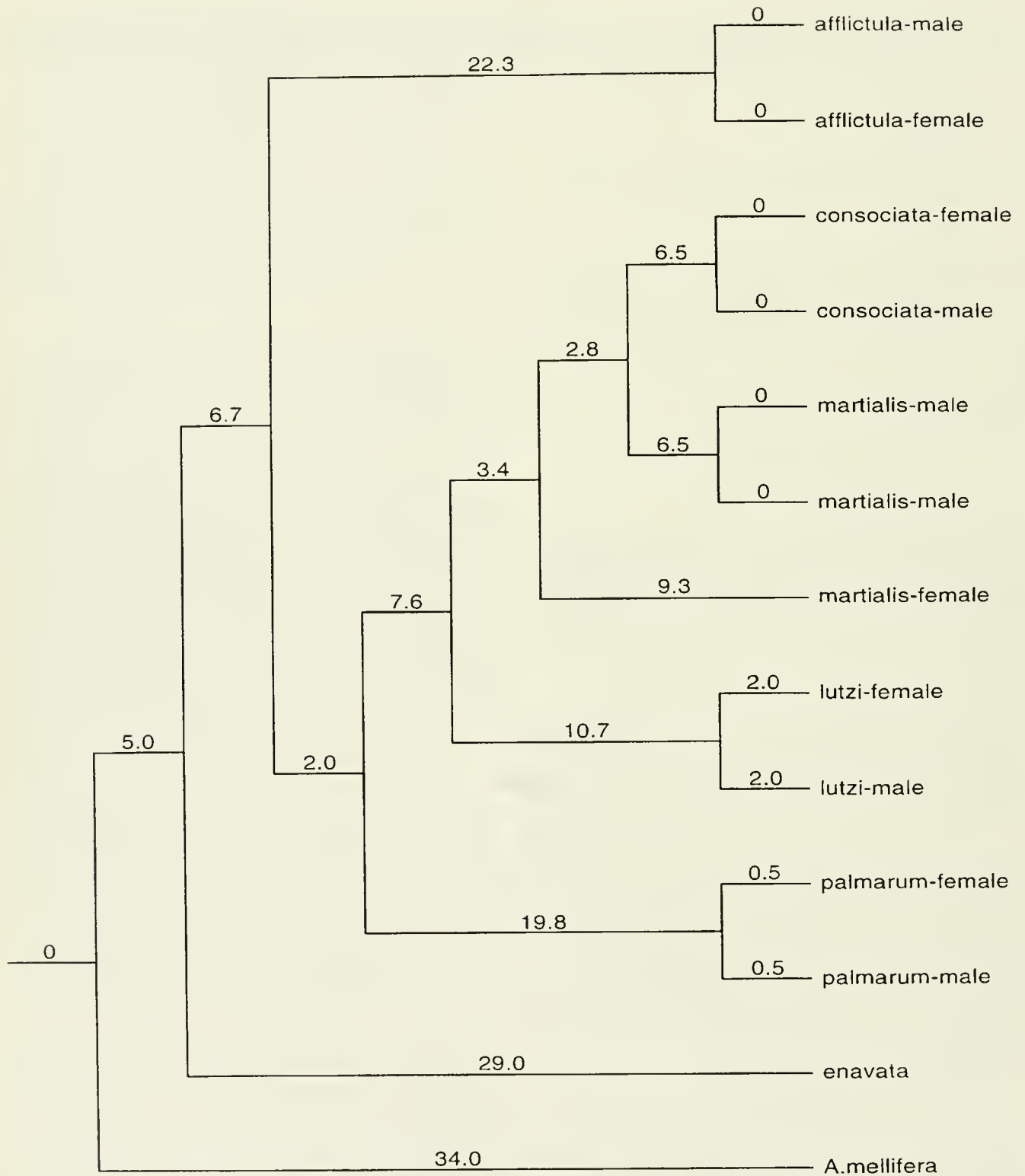

Fig. 1. UPGMA phenogram based on the matrix of absolute distances in Table 2. Numbers on phenogram are branch lengths. The phenogram does not necessarily reflect phylogenetic relationships among the species.

morphologically similar species (Fig. 1). The three *D. martialis* specimens were collected from three geographically proximate sites in Mohave Co., Arizona. The large genetic distance between the *D. martialis* female and males suggests either that the female is of a different species than the male, or that *D. martialis* exhibits a much higher amount of intraspecific variation in this highly conserved gene than the other species examined here. A larger sample of individuals will have to be examined and sequenced to test these hypotheses. I am currently sequencing CO-I and other genes in *Diadasia* for use in phylogenetic reconstruction as well as for use in reevaluating the morphological characters that distinguish closely related species.

LITERATURE CITED

- Adlakha, R. L. 1969. A systematic revision of the bee genus *Diadasia* in America north of Mexico (Hymenoptera: Anthophoridae). Ph.D. dissertation. University of California, Davis, CA.
- Ayala, R., T.L. Griswold, and S.H. Bullock. 1993. The native bees of Mexico. In T.P. Ramamoorthy, R. Bye, A. Lot and J. Fa (eds.). *Biological Diversity of Mexico: Origins and Distribution*. New York, NY: Oxford University Press.
- Aoki, S., C.D. von Dohlen, U. Kurosu, and H. Ishikawa. 1997. Migration to roots by first-instar nymphs, and not by alates, in the gall aphid *Clydesmithia canadensis*. *Naturwissenschaften* 84: 35–36.
- Blanchetot, A., and L. Packer. 1992. Genetic variability in the social bee *Lasiosglossum marginatum* and a cryptic undescribed sibling species, as detected by DNA fingerprinting and allozyme electrophoresis. *Insect Molecular Biology* 1: 89–97.
- Carmen, G.M. and L. Packer. 1997. A cryptic species allied to *Halictus ligatus* Say (Hymenoptera: Halictidae) detected by allozyme electrophoresis. *Journal of the Kansas Entomological Society* 69, suppl. (1996): 169–176.
- Cockerell, T.D.A. 1910. Descriptions and records of bees. xxvii. *Annals and Magazine of Natural History, London* 5: 361–369.
- Crozier, R.H. and Y.C. Crozier. 1993. The mitochondrial genome of the honeybee *Apis mellifera*: Complete sequence and genome organization. *Genetics* 133: 97–117.
- Dowton, M. and A.D. Austin. 1997. Evidence for AT-transversion bias in wasp (Hymenoptera: Symphyta) mitochondrial genes and its implications for the origins of parasitism. *Journal of Molecular Evolution* 44: 398–405.
- Eickwort, G.C., K.R. Eickwort, and E.G. Linsley. 1977. Observations on nest aggregations of the bees *Diadasia olivaceae* and *D. diminuta* (Hymenoptera: Anthophoridae). *Journal of the Kansas Entomological Society* 50: 1–16.
- Linsley, E. G. and J.W. MacSwain. 1957. The nesting habits, flower relationships, and parasites of some North American species of *Diadasia* (Hymenoptera: Anthophoridae). *Wasmann Journal of Biology* 15: 199–235.
- Linsley, E.G., J.W. MacSwain, and R.H. Smith. 1952. The bionomics of *Diadasia consociata* Timberlake and some biological relationships of Emphorine and Anthophorine bees. *University of California Publications in Entomology* 9: 267–290.
- McMichael, M. and H.G. Hall. 1996. DNA RFLPs at a highly polymorphic locus distinguish European and African subspecies of the honeybee *Apis mellifera* L. and suggest geographical origins of New World honey bees. *Molecular Ecology* 5: 403–416.
- Neff, J.L., B.B. Simpson, and L.J. Dorr. 1982. The nesting biology of *Diadasia afflicta* Cress. (Hymenoptera: Anthophoridae). *Journal of the Kansas Entomological Society* 55: 499–518.
- Ordway, E. 1984. Aspects of the nesting behavior and nest structure of *Diadasia opuntiae* Ckll. (Hymenoptera: Anthophoridae). *Journal of the Kansas Entomological Society* 57: 216–230.
- Packer, L., C. Plateaux-Quénu, and R.E. Owen. 1992. Electrophoretic evidence that *Lasiosglossum (Erylaeus) mediterraneum* (Blüthgen) is a species distinct from *L. (E.) laticeps* (Schenck) (Hymenoptera, Halictidae), with notes on its phylogenetic position. *Canadian Entomologist* 124: 371–380.
- Pedersen, B.V. 1996. A phylogenetic analysis of cuckoo bumblebees (*Psithyrus*, Lepeletier) and bumblebees (*Bombus*, Latreille) inferred from sequences of the mitochondrial gene cytochrome oxidase I. *Molecular Phylogenetics and Evolution* 5: 289–297.
- Sambrook, J., E.F. Fritsch, and T. Maniatis. 1989. *Molecular cloning*, 2nd ed. Cold Spring Harbor, NY: Cold Spring Harbor Laboratory Press.
- Scholl, A., E. Obrecht, and R.E. Owen. 1990. The genetic relationship between *Bombus moderatus* Cresson and the *Bombus lucorum* auct. species complex (Hymenoptera: Apidae). *Canadian Journal of Zoology* 68: 2264–2268.
- Simon, C., F. Frati, A. Beckenbach, B. Crespi, H. Liu, and P. Flook. 1994. Evolution, weighting, and phylogenetic utility of mitochondrial gene sequences and a compilation of conserved polymerase chain reaction primers. *Annals of the Entomological Society of America* 87: 651–701.
- Snelling, R. R. 1994. *Diadasia*, subgenus *Dasiapis*, in North America (Hymenoptera: Anthophoridae). *Contributions in Science*, no. 448: 1–8. Natural History Museum of Los Angeles County.
- Stern, D.L., S. Aoki, and U. Kurosu. 1997. Determining aphid taxonomic affinities and life cycles with molecular data: a case study of the tribe Cerataphidini (Hormaphididae: Aphidoidea: Hemiptera). *Systematic Entomology* 22: 81–96.
- Timberlake, P.H. 1941. Synoptic table of North American species of *Diadasia* (Hymenoptera: Apoidea). *Bulletin of the Brooklyn Entomological Society* 36: 1–11.

APPENDIX

SPECIMENS EXAMINED

D. afflicta Ckll.:

Hidalgo Co., NM, 3 km east of Animas on hwy 9, 31°57'25"N, 108°43'2"W, 22 August, 1997, on *Sphaeralcea*, 1 female, S. Sipes, USPIC, Logan.

Hidalgo Co., NM, 1 km north of Animas, 31°56'56"N, 108°48'43"W, 21 August, 1997, on *Malvella leprosa*, 4 males, 1 female, S. Sipes, USPIC, Logan.

Same locality and date, from pan traps, 1 male, 1 female, S. Sipes, USPIC, Logan.

Hidalgo Co., NM, 2 mi southwest of Rodeo, 18 August 1977, on *Sphaeralcea*, 1 male, 4 females, R.J. McGinley, USNM.

Hidalgo Co., NM, 3 mi west of Rodeo, 17 August 1977, on *Sphaeralcea*, 1 female, R.J. McGinley, USNM.

Hidalgo Co., NM, 20 mi south of Animas, 6 April 1977, on *Sphaeralcea*, 2 females, R.J. McGinley, USNM.

Hidalgo Co., NM, 10 mi west of Animas, 20 August 1977, on *Sphaeralcea*, 1 female, R.J. McGinley, USNM.

Nesting Biology and Immature Stages of the South American Bee Genus *Acamptopoeum* (Hymenoptera: Andrenidae: Panurginae)

By

JEROME G. ROZEN, JR.,¹ AND D. YANEGA²

ABSTRACT Information on the nesting biology of *Acamptopoeum prinii* (Holmberg), *A. submetallicum* (Spinola), and *A. argentinum* (Friese) is given, including the following: nesting site characteristics; nest architecture; brood-cell orientation, structure, and lining; description of provisions; egg placement; larval activity; and voltinism. The nesting biology of this genus does not vary significantly from that of *Calliopsis*. Nesting biology of other genera in the Calliopsini is insufficiently known for comparisons to be made.

Males and females of at least *Acamptopoeum submetallicum* fly in copula, a behavior that has been observed in certain other Panurginae and warrants further study.

The mature larva and pupa of *Acamptopoeum prinii* are taxonomically described and illustrated, as is the egg of *A. submetallicum*, the larva of which is also described. The mature larvae of *Acamptopoeum* are similar to, but distinct from, those of *Calliopsis*. Preliminary observations on larval representatives of other Calliopsini (*Arhysosage*, *Spinoliella*, and *Callonychiium*) indicate that they may be similar to one another but quite different from *Acamptopoeum* and *Calliopsis*. This suggests that larvae of all calliopsine genera should be compared and analyzed to illuminate the phylogenetic relationships within the tribe.

Keywords: Nest architecture; Chile; Argentina.

INTRODUCTION

The discovery of a nest of *Acamptopoeum prinii* (Holmberg) in Brazil in January 1997 by the second author (D.Y.) occasioned the following descriptive notes on its structure and contents and has led to the descriptions of the mature larva and pupa of the species by the first author (J.G.R.). J.G.R. briefly studied the nest of *A. submetallicum* (Spinola) and collected nest components and some immatures in Chile in 1994. He also made brief notes on the nest of *A. argentinum* (Friese) in Argentina in 1989. The information on these three species is presented here so that it can eventually shed light on the phylogenetic relationships and taxonomy of the Panurginae, especially the Calliopsini.

The genus *Acamptopoeum* consists of seven or eight, moderate-sized species all of which occur in South America, with the possible exception of *A. maculatum* (Smith) (Ruz, 1991; Shinn, 1967). It is of phylogenetic interest because Ruz (1986) at first postulated that it was the basal clade in the New World tribe Calliopsini. Later Ruz (1991) proposed that it was a sister group only to *Calliopsis* sensu lato and that together they were a sister group to the three other calliopsine genera (*Arhysosage*, *Spinoliella*, and *Callonychiium*), all from South America. We follow Ruz (1991) by adopting her classification of *Calliopsis*. Although *Calliopsis* is the only calliopsine genus known from both

North and South America, none of its eleven subgenera is amphitropical.

The only original published data on nesting habits for *Acamptopoeum* were given by Claude-Joseph (1926) for the Chilean *A. submetallicum* (referred to by Rozen, 1967). He described and illustrated its mature larva in the same paper. His account of the larva was interpreted subsequently by Michener (1953), who did not have an opportunity to examine specimens.

Specimens (immatures and adults) of *Acamptopoeum prinii* and *A. submetallicum* from this study are in the collections of the American Museum of Natural History, as are samples of cells and cell closures of *A. submetallicum* and *A. argentinum*.

ACKNOWLEDGMENTS

Work by D.Y. in Brazil was supported by a visiting research grant [301019/96-7 (NV)] from "Conselho Nacional de Desenvolvimento Científico e Tecnológico" (CNPq). Field collecting in Chile that led to the discovery of the nests of *Acamptopoeum submetallicum* was sponsored by National Science Foundation grant BSR-9024566 to the American Museum of Natural History, Dr. Norman I. Platnick, PI.

We dedicate this paper to the memory of our friend Byron A. Alexander, thoughtful scholar whose contributions to entomology will long be admired.

¹ Department of Entomology, American Museum of Natural History, New York, NY 10024. E-mail: rozen@amnh.org

² Depto. Biologia Geral, Instituto de Ciências Biológicas Universidade Federal de Minas Gerais, Belo Horizonte, MG, BRAZIL. Present address: Department of Entomology, Entomology Research Museum, University of California, Riverside, CA 92521. E-mail: dyanega@pop.ucr.edu

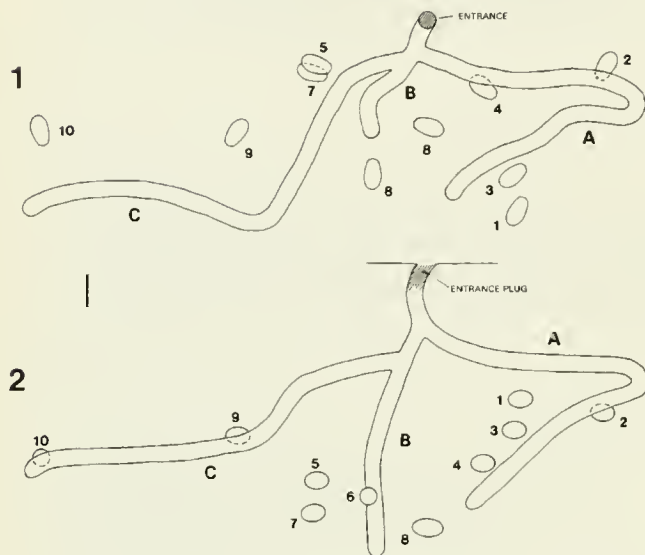

Figs. 1-2. Diagram of nest architecture of *Acamptopoeum prinii*; for explanation, see Table 1 and text. 1-Top view. 2-Side view. Scale (=1 cm) refers to both figures.

NESTING BIOLOGY

Acamptopoeum prinii

The study site was in a nearly horizontal, bare trail of hard-packed dirt, roughly 3 m wide, on the periphery of the campus of the Universidade Federal de Minas Gerais (UFMG), in Belo Horizonte, Minas Gerais, Brazil. The nest entrance, unshaded during most of the day, was approximately 30 cm from the nearest trailside vegetation, which at that point was low and herbaceous. D.Y. found the nest on January 22, 1997, when he observed a male returning to the same spot several times within a short period, acting as if searching the ground. D.Y. excavated the nest a week later.

The nest entrance was closed with loose soil and surrounded by a very slight trace of a tumulus. It is uncertain to what depth the closure penetrated, but the tunnel (Fig. 2) below the entrance was vertical for only a short distance (approximately 2 cm) before branching laterally, and the branches did not appear to be soil-filled. The branches meandered downward, as indicated in Figs. 1, 2. The relative ages of the cells (as determined by the immatures, Table 1) suggest that the three branches (A-C) of the nest were excavated and provisioned sequentially, presumably by the single female, which was found at the end of the newest branch (C). Probably considerably more time elapsed between construction of tunnels B and C than A and B, given the disparity in developmental stages (Table 1). The

Table 1. Statistics and cell contents of nest of *Acamptopoeum prinii*.

Branch	Cell	Cell depth (cm)	Lateral length (mm)	Cell length × diameter (mm)	Contents
A	1	4	24	10.5 × 5	male pupa (damaged)
A	2	4.5	12	10 × 5	male pupa
A	3	5	10	10 × 5	male pupa
A	4	6	18	n.a.	postdefecating larva (starting ecdysis)
B	5	6.5	11	10 × 5	predefecating larva
B	6	7	16	10 × 5	defecating larva
B	7	7.5	10	9 × 5	predefecating larva
B	8	8	13	n.a.	predefecating larva
C	9	5	21 (curved)	9 × 5	egg and provision sphere
C	10	5.5	n.a.	n.a.	provision sphere

burrow diameter was relatively uniform, approximately 5 ± 1 mm, and the three burrows ended blindly, not in cells. Each terminated at the following depths: A-7.5 cm; B-9 cm; C-6.5 cm. The entire complex of cells spread over roughly 18 cm E-W and 6 cm N-S. Order of cell construction and closure in a branch does not appear to be uniform from one branch to the next; in A the youngest individual was the lowest, but in B younger individuals were both above and below the oldest.

Ten cells were encountered, all closed, and none as yet vacated. They were at the end of soil-filled laterals (mostly straight and horizontal, one curving laterally) of roughly 1-2 cell-lengths. Well-defined, spiral cell closures were not detected, although they may have been obscured by fine, loose soil particles or damaged during excavation. Cells were subhorizontal, with the far end slightly lower and, in side view, almost symmetrically elliptical, with rounded rear ends. Cell walls, not noticeably harder than the substrate, were smooth but slightly rougher near the closure and exhibited a thin, faintly shiny, transparent inner coating that was not separable from the surrounding soil.

Stored food masses were located close to the far end of the cell and were almost perfect spheres, roughly half a cell-width in diameter (one measured 2.6 mm in diameter). They were composed of a mixture of large spherical pollen grains and much smaller spherical pollen grains with diameters one-half to one-third of those of the large grains. They formed a semisolid matrix that showed no trace of coating when fresh, and, when broken apart later in alcohol, revealed no traces of any sort of special outer coating, film, or membrane under microscopic examination. When stored in alcohol, these food masses retained their shape and did not break or fall apart. Indeed, the individual pollen grains continued to adhere to one another even when

the provisions were broken apart with forceps. These facts suggest that clumping of pollen grains was not caused by nectar (which would have been dissolved in the alcohol) nor by any sort of material coating the provisions.

Egg placement was visible in only one cell, in which the egg may have been displaced slightly from normal orientation (the egg itself was damaged when the cell was opened). The egg, white and moderately elongate, apparently was placed dorsally (or possibly slightly toward the rear of the cell) on the provision mass, with the egg's long axis aligned along the cell axis. The three pupae in the nest were all males, but no other nests were found to establish whether order of production of the two sexes is consistently protandrous. In the cells containing pupae and the postdefecating larva, feces were found on the rear ceiling.

The defecating larva, when preserved, was thought to be a postdefecating form because the body was slender, the paired dorsal abdominal tubercles (Fig. 4) were more pronounced than those of predefecating larvae (Fig. 5), and pupal tissue was already becoming organized within the larval integument. However, when dissected and partly cleared in an aqueous solution of sodium hydroxide, the midgut still contained some ingested pollen. The external shape of the larva was probably similar to that of a postdefecating larva before it conforms to the shape of the developing pupa. However, because pupal tissue was visible in predefecating larvae as well as in the defecating larva, a postdefecating body form unmodified by the pupal physiognomy must be a fleeting phenomenon when the larva does not enter diapause.

A postdefecating larva preserved as it was starting ecdysis revealed how the pupa was encased in the larval integument immediately after the integument split along the dorsal midline and before the pupa started to emerge. The curled pupal antennae occupied nearly the entire larval head capsule, the pupal head was contained in the larval prothorax, the pupal prothorax and mesoscutum occupied the dorsum of the larval mesothorax, and the pupal mesoscutellum was accommodated by the larval metathorax. The large, paired, pupal mesoscutellar tubercles occupied the paired dorsal metathoracic tubercles of the larva.

The presence of pupae in the nest and the absence of quiescent, diapausing larvae indicated that this species has more than one generation a year.

Acamptopoeum submetallicum

A nesting site of this species was discovered near the top of Cuesta Gavilolén, northeast of Los Vilos, Choapa Province, Chile, on October 16, 1994. J.G.R. observed males flying in long sweeps over the mostly barren nesting area

and males and females flying in copula.³ In one case the male was seen to disengage only when the female descended into her burrow. The nesting area was in the nearly level, unshaded surface at the bottom of a small ravine; the day was partly sunny and cool (less than 65 °F except when the sun was out). Nests were widely scattered and five of them were excavated.

The nesting season was just beginning, as indicated by the absence of older larvae and the reduced number of cells in some nests. All nest entrances possessed abundant tumuli, and main burrows were plugged with soil at the surface. Three of the five nests each contained two adult females, and one of these nests contained a single cell. Another nest also consisted of a single cell, two nests contained 4–5 cells, and no data were recorded on the last nest except to note that it too was closed with soil at the surface. Multi-celled nests seemed to consist of a single burrow from which laterals radiated, as opposed to the branching configuration of the nest of *Acamptopoeum prinii*. The unbranching nests of *A. submetallicum* may have been an artifact created by examining nests in early construction. However, Claude-Joseph's (1926: p. 207) depiction of the nest also showed a single descending main tunnel.

Main tunnels meandered downward, as was also the case for the branches of *Acamptopoeum prinii*. Two were approximately 5 mm in diameter near the surface, and one was 4 mm wide at the surface but opened to 6 mm at lower depths.

Cells were arranged singly, each with its own lateral, soil-filled after closure, as was the case for *Acamptopoeum prinii*. They were essentially symmetrical around their long axis. Cell lengths ranged from 10 to 11 mm (N=2); maximum cell diameter was 6.5–7.0 mm (N=5); minimum diameter of cell entrance was 4.0–4.5 mm (N=4). Cell orientation was nearly horizontal with the rear slightly lower than the front end. The cell wall consisted of soil not discernibly different from that of the substrate except for being more consolidated and therefore tending to remain intact when excavated by J.G.R. The hard cell wall contrasts with that of *A. prinii*, but detection of a hard cell wall may depend on soil moisture and nature of substrate as much as on manipulation of the wall material by the female during construction. The inner cell surface was mostly smooth but somewhat rougher next to the cell closure. The smooth surface was dark and possessed a shiny, transparent lining when first exposed. The lining remained faintly shiny when dry and was water retardant when tested. The rough surface near the closure lacked the lining (or the

³ J. G. R. again observed pairs of *Acamptopoeum submetallicum* flying in copula, at 5 km. W. Monte Patria, Limari Province, Chile, on October 6, 1997. Here two couples were visiting a yellow composite. The female of one was carrying pollen on her hind legs, an indication that females forage while in copula.

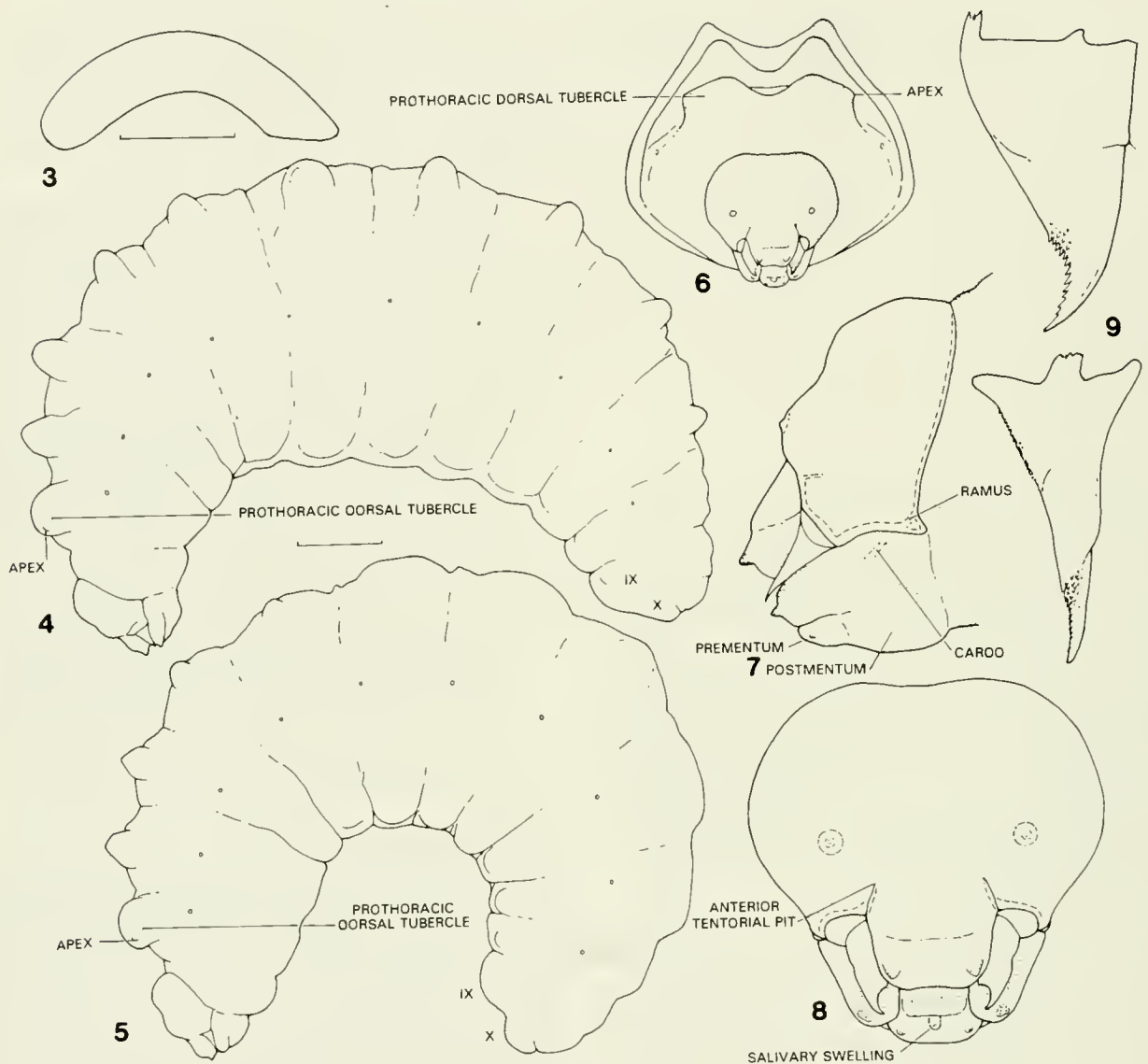

Figs. 3-9. 3-Egg of *Acamptopoeum submetallicum*, lateral view, anterior end at left. 4-9. Mature larva of *Acamptopoeum prinii*. 4-Defecating larva, lateral view. 5-Predefecating larva, lateral view. 6-Defecating larva, frontal view, enlarged, showing pigmentation pattern on right. 7-Head, lateral view. 8-Head, frontal view. 9-Right mandible, ventral and inner views. Scales (=1 mm) refer to Figs. 3-5, respectively.

lining may have been fenestrated) and was water absorbent when tested. A similar situation is reported below for the cell surfaces of *A. argentinum*.

Cell depths ranged from 5 to 9 cm, essentially the same as those of *Acamptopoeum prinii*.

Cell closures were a well-formed, slightly concave spiral of about 4 coils on the inside, much as reported by Claude-Joseph (1926). Hence, this feature appears to contrast with the inner surface of the closure of *Acamptopoeum prinii*. One preserved closure, with a center thickness of about 1 mm, revealed a more or less smooth, evenly con-

cave outer surface, against which the female had piled the fill of the lateral.

As in *Acamptopoeum prinii* and *A. argentinum*, larval provisions were perfect spheres, 3.9-4.4 mm (N=2) in diameter, apparently considerably larger than those of *A. prinii*. These spheres appeared to have a thin, transparent coating in contrast to those of *A. prinii* and *A. argentinum*. The reported difference is significant since coated provisions have been reported for many Calliopsini and some Perditini. Fresh provisions of all species should be re-examined carefully to confirm this feature.

Two eggs (Fig. 3) preserved in Kahle's solution were nearly white and possessed a clear, smooth, transparent chorion. Strongly curved, they were 2.5 mm long and 0.5–0.6 mm in maximum diameter, with a round anterior end, an elongate, parallel-sided midsection, and a rather short, rapidly narrowing posterior end. The fact that one of the eggs had a mass of pollen adhering to the posterior end suggests that the egg was attached to the pollen mass by this end.

A single larva, described below and reared in the laboratory, was preserved as a postdefecating form on November 9, 1994. This information, as well as Claude-Joseph's (1926: p. 207) account, suggests that *Acamptopoeum submetallicum*, in contrast to *A. prinii*, has a single generation per year.

Acamptopoeum argentinum

A single nest of this species was discovered and excavated at San Fernando, Catamarca Province, Argentina, on November 3, 1989, by J.G.R. It was found at the side of an unpaved, essentially horizontal, unshaded roadway, where the soil was sandy. The soil was powdery and dry on the surface but moist and firmer 2–3 cm below.

The single female was seen disappearing into the powdery surface. No nest entrance was discernible, and the main burrow was not detected, perhaps because it had been soil-filled. Laterals to closed cells were soil-filled; one leading to an open cell was 4.0 mm in diameter except just before the cell mouth where it narrowed to 3.5 mm.

All four cells were arranged singly at a depth of 7–8 cm and were subhorizontal, tipping to the rear by about 10°. Cell dimensions were: maximum diameter 5.8–6.2 mm (N=2); length 10.2 mm (N=1). A cell wall differentiated from the substrate was not certainly detected. The inner surface of the cell was very smooth over the rear two-thirds and less so over the front one-third. When tested with water droplets, the smooth area was highly water retardant and the front, somewhat rougher surface was immediately absorbent. However, at the time of excavation, the entire surface appeared shiny.

Cell closures were a moderately concave spiral on the inside of approximately three coils and a relatively smooth concave surface on the outside, probably with a center thickness similar to that of *Acamptopoeum submetallicum*.

Provisions were spheres 4.0–4.2 mm (N=3) in diameter that rested on the floor of the cell. They were quite firm and not coated by a waterproof lining. When broken apart, one consisted of yellow pollen toward the outside and orange pollen inside, suggesting that two kinds of plants had been visited by the foraging female.

One cell contained a strongly arched, whitish egg with

a shiny, clear chorion. It was 2.2 mm long and 0.55 mm in maximum diameter, with one end (presumably front) round, and the other more tapering.

IMMATURE STAGES

MATURE LARVA OF *ACAMPTOPOEUM PRINII*

Diagnosis.—(Figs. 4–9) See Diagnosis of *Acamptopoeum submetallicum*, below.

This description follows the format of that of the larva of *Anthemurgus passiflorae* Roberston (Neff and Rozen, 1995).

Head.—(Figs. 7, 8) Integument of head capsule with scattered, inconspicuous sensilla, which were not obviously setiform; head capsule, maxillary and labial palpi, and, apparently, lower end of salivary swelling (see Remarks, below) faintly pigmented; mandibles and their attachments to subgenal ridge more darkly pigmented than elsewhere.

Head moderately small in relation to rest of body; head capsule much wider than maximum length from vertex to lower clypeal margin. Anterior tentorial arms slender but present; posterior arms present, arising from deeply inflexed posterior pits; tentorial bridge and dorsal arms (of defecating larva) absent, presumably because individual was nearing ecdysis; anterior and posterior tentorial pits in normal position; postoccipital ridge normal in position, thin, almost absent at midline of head (perhaps as result of approaching ecdysis); median longitudinal thickening of head capsule absent; hypostomal ridge well developed with ramus connecting to postoccipital ridge because of deep inflexion of head capsule at posterior tentorial pit; pleurostomal ridge moderately developed; epistomal ridge well developed between anterior mandibular articulation and anterior tentorial pit, absent between anterior tentorial pits. Parietal bands indistinct, scarcely noticeable. Antennal prominences moderately low; antennal papilla and disc small; papilla short, distinctly shorter than its basal diameter, with three sensilla. Vertex in lateral view (Fig. 7) evenly rounded; frontoclypeal area normal in length. Labrum normal in size and shape for Panurginae, without sclerite; paired labral tubercles arising from disc, moderate in size; epipharyngeal surface strongly spiculate on sides but nonspiculate medially.

Mandible slender, gradually tapering apically in adoral view (Fig. 9); dorsal surface spiculate; outer surface with inconspicuous seta-bearing irregularity (too indistinct to be called a tubercle) one-third distance to apex; apex attenuate with row of denticles along upper apical edge, without enlarged subapical tooth; ventral apical edge without denticles; cusp weakly produced adorally, not produced ventrally, with numerous, evenly spaced denticles,

but without large tooth. Labiomaxillary region (Fig. 7) moderately recessed and fused as in other Panurginae. Maxilla in lateral view (Fig. 7) projecting moderately beyond labial apex; cardo a vague, unpigmented cuticular thickening; stipes and articulating arm of stipes not evident; palpus moderate in size, equal to or somewhat smaller than labral tubercle, directed forward (rather than down-turned), with dorsal surface curving downward no more than ventral surface curving upward; dorsal surface of maxilla and palpus spiculate, spicules large. Labium weakly divided into prementum and postmentum; premental sclerite not evident; in lateral view (Fig. 7), labial apex clearly recessed compared to apices of maxillary palpi; labial palpus moderate in size but conspicuously smaller than maxillary palpus. Salivary opening in curved groove that extends to hypopharyngeal groove; salivary swelling extending no farther than apex of labium on either side. Hypopharyngeal groove deep; hypopharynx strongly spiculate dorsally.

Body.—Integument without obvious setae but anterior paired dorsal tubercles with a few microscopic, setiform sensilla; body spiculation extensive in many areas, but paired dorsal tubercles of thorax and first abdominal segment nonspiculate; other paired dorsal tubercles with apices finely, densely spiculate; venter of body inconspicuously spiculate by comparison with many dorsal areas; integument of paired dorsal thoracic tubercles and those of first abdominal segment pigmented about as darkly as head capsule (Fig. 6). Body form (Fig. 4) of defecating larva moderately robust; that of predefecating larva (Fig. 5) somewhat more so; intrasegmental lines not evident; lateral prothoracic swelling absent (this feature should be evaluated on postdefecating larva); thoracic segments and first abdominal segment of both defecating and predefecating larvae with paired dorsal tubercles; paired dorsal tubercles evident on abdominal segments II–VII of defecating larva (Fig. 4) but absent or nearly so on predefecating larva (Fig. 5); anterior body tubercles tending to be conical but posterior ones more or less transverse (but not pronouncedly so as in Halictinae); prothoracic dorsal tubercles large, with apex of each directed forward (Figs. 4, 5) and laterad (Fig. 6); bases of pro- and mesothoracic tubercles not certainly forming pockets, as described for *Anthemurgus* (but this character perhaps better evaluated on postdefecating larva); bases of meso- and metathoracic paired dorsal tubercles apparently not forming pockets; dorsal tubercles of abdominal segment VIII of defecating larva faint, those of segments IX and X absent; pleural region not produced; venter of most abdominal segments slightly produced on each side; abdominal segment X attached dorsally to IX on predefecating larva (Fig. 5), not as

distinctly so on defecating larva (Fig. 4). Spiracles small, unpigmented, subequal in size; peritreme present; atrium projecting slightly beyond body wall, with rim; atrial wall with faint ridges parallel with atrial rim; subatrium of moderate length, with about ten chambers. Gender characters not detected.

Material Studied.—One defecating larva, three predefecating larvae, and one postdefecating larva starting ecdysis, Belo Horizonte, UFMG, Minas Gerais, Brazil, 1–29–1997 (D. Yanega).

Remarks.—Problems exist in our understanding of the anatomical variation in the labiomaxillary/hypopharyngeal regions of bee larvae. The salivary swelling was so named and first identified by Rozen (1993) with reference to *Euherbstia* (Andreninae) and later referred to as a salivary tubercle in *Ancylandrena* (Andreninae) (Rozen, 1994) and *Neffapis* (Panurginae) (Rozen and Ruz, 1995). However, in another sense the swelling had been identified earlier by McGinley (1981: p. 25, character 79, state 3) when he described the salivary opening as being strongly upcurved. The area enclosed by the upcurved opening and the hypopharyngeal groove is the salivary swelling. He pointed out that the strongly upcurved salivary opening was possibly an andrenid autapomorphy. If this proves to be true, then the swelling is also an andrenid autapomorphy, although the extent of projection of the swelling varies from taxon to taxon within the family.

The salivary swelling appears to be a different feature from the salivary plate, a term used by McGinley (1981: p. 26, character 83) for a structure in certain cocoon-spinning bee larvae. Both features are associated with the salivary opening. However, the former is circumscribed by the upcurved opening and the hypopharyngeal groove, and the opening itself does not project because the larva is noncocoon-spinning. In the latter, the plate surrounds the salivary opening, which is projecting, and is found only on cocoon-spinning larvae of the Melittidae⁴, Meganomiidae⁴, and the Diphaglossinae, as reported by McGinley (1981). It is unclear whether or not the salivary plate of the diphaglossines is homologous with that of the melittids and meganomiids.

McGinley (1981: character 87) referred to a sclerotized ramus associated with the hypopharyngeal groove (p. 27) and later to a hypopharyngeal groove that is sclerotized laterally (pp. 59–60) (presumably references to the same structure). Rozen and Michener (1988) interpreted this sclerotized structure to be the articulating arm of the stipital sclerite, actually a part of the maxilla.

⁴ *Sensu* Alexander and Michener (1995).

POSTDEFECATING LARVA OF *ACAMPTOPOEUM SUBMETALLICUM*

Diagnosis.—The single, laboratory-reared, postdefecating larva described here was shrunken and perhaps deformed, presumably because it was reared under unnatural conditions. Furthermore, the body contents did not completely dissolve when treated repeatedly with an aqueous sodium hydroxide solution, perhaps because the larva was infected by fungal hyphae. However, some of its features can be compared with those of *Acamptopoeum prinii*. The only characteristic identified to separate the larva of this species from larvae of *A. prinii* is the presence of teeth along the lower apical edge of the mandible (but see Rozen [1958: p. 25] for a discussion of the taxonomic reliability of such a larval feature). Perhaps the significant point of the following description is the similarity of the larvae of the two species.

See section of Taxonomic and Phylogenetic Interpretations, below, for characters that distinguish mature larvae of *Acamptopoeum* from those of other Calliopsini.

Head.—As described for *Acamptopoeum prinii* except for following: Head size relative to body size uncertain because of shrunken condition of body. Condition of inflexion of posterior pits, tentorial bridge, hypostomal ridge, pleurostomal ridge, and epistomal ridge unknown. Labral tubercles evident. Mandible with ventral apical edge bearing distinct denticles in addition to those on upper apical edge; cuspal teeth apparently greatly reduced compared with those of *A. prinii*. Labiomaxillary region including salivary opening and hypopharynx greatly distorted.

Body.—As described for *Acamptopoeum prinii* except for following: Body spiculation pattern unknown. Body form of postdefecating larva presumably moderately robust but larva somewhat shrunken because reared under laboratory conditions; thoracic segments and abdominal segments I–VII with paired dorsal tubercles; those of abdominal segments VIII low but evident (all dorsal body tubercles may have been accentuated because of shrunken body); prothoracic dorsal tubercles large with apex of each directed forward and laterad as in *A. prinii*, but apex not so strongly produced as in that species; bases of pro- and mesothoracic and meso- and metathoracic paired dorsal tubercles apparently not forming pockets; dorsal tubercles of segments IX and X absent; pleural regions produced, apparently owing to shrunken condition of body; abdominal segment X attached somewhat dorsally to IX as seen in lateral view.

Material Studied.—One postdefecating larva, 33 km NE Los Vilos, Choapa Province, Chile, collected X–16–1994 as intermediate larva, preserved XI–7–1994 as postdefecating larva (Rozen, Quinter, and Ascher).

PUPA OF *ACAMPTOPOEUM PRINII*

The main purpose of the following description is to record the distinctive pupal characteristic of *Acamptopoeum prinii* for future systematic analysis. The diagnosis may enable this pupa to be distinguished from known pupae of other panurgines, as listed in Neff and Rozen (1995).

Diagnosis.—(Figs. 10–12) The pupa of *Acamptopoeum prinii* possesses the following combination of diagnostic features (Figs. 10, 11): tegular tubercles present; paired scutal tubercles distinct; hind tibia with basal tubercle on outer surface. It therefore can be distinguished from known pupae of the following panurgine genera, which do not possess one, two, or all three of these characteristics: *Perdita*, *Callonychium*, *Heterosarus*, *Melitturga*, *Anthemurgus*, *Protandrena*, *Panurginus*, *Psaenythia*, and *Liphanthus*. These same features will distinguish it from some but not all subgenera of *Calliopsis* sensu lato. The irregular surface of the upper part of the pupal compound eye of *A. prinii* as seen in frontal view (Fig. 12) (contrasting with an evenly curved surface) has not been reported for any other panurgine.

Description.—Length 6.9–7.4 mm; body without setae.

Head.—Scape unmodified except for small apical projection (tubercle) next to compound eye; pedicel with small tubercle next to eye. Mandible without tubercle, but malar area with small tubercle immediately below compound eye (no doubt homologous with tubercle incorrectly called “genal tubercle” in Neff and Rozen, 1995: fig. 21). Vertex with conspicuous rounded median tubercle on each side (see Remarks for explanation of terminology) near lateral ocellus; median ocellar tubercle virtually absent; lateral vertical tubercle and upper frontal tubercle low, scarcely noticeable, verruculose. Compound eye with upper surface slightly irregular as seen in frontal view (Fig. 12).

Mesosoma.—Lateral angles of pronotum scarcely evident; lateral lobes of pronotum pronounced, tuberculate, best viewed dorsally (Fig. 10); mesoscutum with pair of moderate-sized, sharply erect, paramedian tubercles; mesoscutellum with pair of large tubercles; axilla produced as low mound; metanotum strongly produced medially; mesepisternum without tubercle. Tegula with low, distinct tubercle. Front and hind wings each with basal swelling, best seen in dorsal view (Fig. 10). Each coxa with small, acute, ventral tubercle; each trochanter with moderate-sized, acute, apical tubercle; anterior femur somewhat swollen ventrally at base, mid- and hind femora less swollen ventrally at base; fore- and hind tibiae, but not midtibiae, with outer apical projection; hind tibia with distinct acute basal tubercle on outer surface.

Metasoma.—Terga I–VI with transverse row of acute, moderate-sized tubercles, most of which are apically

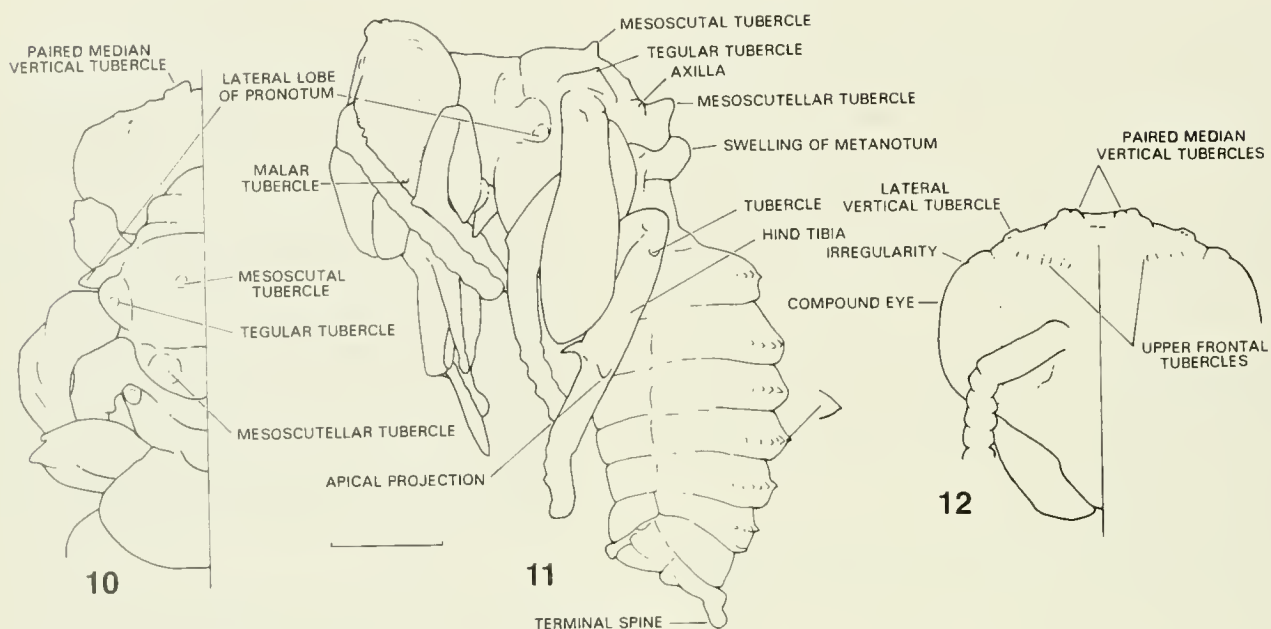

Figs. 10–12. Pupa of *Acamptopoeum prinii*. 10—Anterior part of body, dorsal view. 11—Entire body, lateral view. 12—Head (partial), enlarged, frontal view. Scale (=1 mm) refers to Figs. 10 and 11.

pointed (see enlargement, Fig. 11). Sterna without tubercles. Terminal spine, short, apically rounded.

Material Studied.—Two male pupae, Belo Horizonte, UFMG, Minas Gerais, Brazil, I–29–1997 (D. Yanega).

Remarks.—Tubercles on the vertex and upper frons are a common, but not universal, feature among the Panurginae. The position of these tubercles appears to be constant, suggesting that, where present, they can be homologized from one genus to the next even though the extent of their expression varies. Names applied to them were adopted from Neff and Rozen (1995: fig. 20).

TAXONOMIC AND PHYLOGENETIC INTERPRETATIONS

Information presented here, as well as that provided by Claude-Joseph (1926), indicates that *Acamptopoeum* is a shallow-nesting genus, examined species of which excavate meandering tunnels and laterals that lead to usually single, subhorizontal cells. Entrances to active nests are kept clogged and sometimes are completely hidden by loose surface soil. Females waterproof most of the inner surface of brood cells, presumably with a secretion. Provisions are shaped into a sphere that rests on the cell floor, and an arched egg is deposited on the top of the sphere. Laterals are soil-filled after cell closure. Young larvae remain stationary on their provisions while they feed, and later reorient to rest on their dorsa. At the end of feeding,

larvae deposit feces on the rear ceiling of the cell. In all of these respects, the nesting biology of the genus is similar to what is known about the genus *Calliopsis* sensu lato (Danforth, 1990; Rozen, 1958, 1963, 1967 [and references therein, p. 4], 1970; Rust, 1988; Shinn, 1967).

The only published information on nesting biology about other genera of the Calliopsini was given by Claude-Joseph (1926) for *Spinoliella*. This account is brief, and details given do not present features that distinguish the genus from either *Calliopsis* or *Acamptopoeum* on the basis of nesting biology. Hence, additional studies of *Spinoliella* are needed as are published investigations on the nesting biology of *Arhysosage* and *Callonychium*. After comparative data are available, they can be interpreted phylogenetically.

Aside from aspects of nesting biology, mating behavior for one species of *Acamptopoeum* is known. Flying in copula, observed in *A. submetallicum*, has also been noted for some subgenera of *Calliopsis* as well as for some species of *Callonychium*, *Arhysosage*, and *Perditini* (Rozen, 1958, 1963, 1970, and unpublished observations; Shinn, 1967). Further data regarding mating behavior should be gathered for analysis.

Mature larvae of *Acamptopoeum* obviously share many characters with those of *Calliopsis* (see McGinley, 1989, for references) but apparently can be distinguished on the basis of the large prothoracic tubercles, apices of which are di-

rected forward and laterad (Figs. 4–6), and on the basis of the faint pigmentation of the integument of all thoracic dorsal tubercles and those of the first abdominal segment. The more-or-less transverse shape of the dorsal tubercles toward the posterior part of the abdomen may also be distinctive.

Mature larvae of only *Spinoliella* of the other calliopsine genera have been illustrated and described (Claude-Joseph, 1926). However, J.G.R. has collected mature larvae of *Spinoliella*, *Arhysosage*, and *Callonychiium* although they have yet to be studied. Larvae of these three genera have highly modified dorsal prothoracic tubercles and somewhat modified mesothoracic tubercles, and the other body tubercles are conical, slender, and tapering (as suggested by Claude-Joseph's illustration (1926: fig. 59). Hence, larvae of these genera are quite unlike those of both *Acamptopoeum* and *Calliopsis*. A phylogenetic analysis of all genera of the Calliopsini based on larval characters should be revealing, after available specimens are studied.

LITERATURE CITED

- Alexander, B. A., and C. D. Michener. 1995. Phylogenetic studies of the families of short-tongued bees (Hymenoptera: Apoidea). University of Kansas Science Bulletin 55: 377–424.
- Claude-Joseph, F. 1926. Recherches biologiques sur les Hyménoptères du Chili (Mellifères). Annales des Sciences Naturelles, Zoologie, Series 10, 9: 113–268. [in French]
- Danforth, B. N. 1990. Provisioning behavior and the estimate of investment ratios in a solitary bee, *Calliopsis* (*Hypomacrotera*) *persimilis* (Cockerell) (Hymenoptera: Andrenidae). Behavioral Ecology and Sociobiology 27: 159–168.
- McGinley, R. J. 1981. Systematics of the Colletidae based on mature larvae with phenetic analysis of apoid larvae (Hymenoptera: Apoidea). University of California Publications in Entomology 91: 307 pp.
- McGinley, R. J. 1989. A catalog and review of immature Apoidea (Hymenoptera). Smithsonian Contributions to Zoology 494: 24 pp.
- Michener, C. D. 1953. Comparative morphology and systematic studies of bee larvae with a key to the families of hymenopterous larvae. University of Kansas Science Bulletin 15: 987–1102.
- Neff, J. L., and J. G. Rozen, Jr. 1995. Foraging and nesting biology of the bee *Anthemurgus passiflorae* (Hymenoptera: Apoidea), descriptions of its immature stages, and observations on its floral host (Passifloraceae). American Museum Novitates 3138: 19 pp.
- Rozen, J. G., Jr. 1958. Monographic study of the genus *Nomadopsis* (Hymenoptera: Andrenidae). University of California Publications in Entomology 15: 202 pp.
- Rozen, J. G., Jr. 1963. Notes on the biology of *Nomadopsis*, with descriptions of four new species (Apoidea, Andrenidae). American Museum Novitates 2142: 17 pp.
- Rozen, J. G., Jr. 1967. Review of the biology of panurgine bees, with observations on North American forms (Hymenoptera, Andrenidae). American Museum Novitates 2297: 44 pp.
- Rozen, J. G., Jr. 1970. Biology and immature stages of the panurgine bee genera *Hypomacrotera* and *Psaenythia* (Hymenoptera, Apoidea). American Museum Novitates 2416: 16 pp.
- Rozen, J. G., Jr. 1993. Phylogenetic relationships of *Euerbstia* with other short-tongued bees (Hymenoptera: Apoidea). American Museum Novitates 3060: 17 pp.
- Rozen, J. G., Jr. 1994. Biologies of the bee genera *Ancylandrena* (Andrenidae: Andreninae) and *Hexepeolus* (Apidae: Nomadinae) and phylogenetic relationships of *Ancylandrena* based on its mature larva (Hymenoptera: Apoidea). American Museum Novitates 3108: 19 pp.
- Rozen, J. G., Jr., and C. D. Michener. 1988. Nests and immature stages of the bee *Paratetrapedia swainsonae* (Hymenoptera: Anthophoridae). American Museum Novitates 2909: 13 pp.
- Rozen, J. G., Jr., and L. Ruz. 1995. South American panurgine bees (Andrenidae: Panurginae), Part II. Adults, immature stages, and biology of *Neffapis longilingua*, a new genus and species with an elongate glossa. American Museum Novitates 3136: 15 pp.
- Rust, R. W. 1988. Biology of *Nomadopsis larreae* (Hymenoptera: Andrenidae), with an analysis of yearly appearance. Annals of the Entomological Society of America 81: 99–104.
- Ruz, L. 1986. Classification and phylogenetic relationships of the panurgine bees (Hymenoptera-Andrenidae). Doctoral Dissertation, University of Kansas, 312 pp.
- Ruz, L. 1991. Classification and phylogenetic relationships of the panurgine bees: the Calliopsini and allies (Hymenoptera: Andrenidae). University of Kansas Science Bulletin 54: 209–256.
- Shinn, A. F. 1967. A revision of the bee genus *Calliopsis* and the biology and ecology of *C. andreniformis* (Hymenoptera, Andrenidae). University of Kansas Science Bulletin 66: 753–936.

An Inventory Of Arthropod Fauna At Great Sand Dunes National Monument, Colorado

By

MICHAEL J. WEISSMANN¹ AND BORIS C. KONDRATIEFF¹

ABSTRACT Over 900 species of arthropods are listed from Great Sand Dunes National Monument, Alamosa and Saguache counties, Colorado. The list is compiled from specimens collected by more than 30 researchers over a period of six decades. The inventory includes four species that are apparently endemic to the Monument and surrounding habitat.

Keywords: Arthropod; Biodiversity; Colorado; Great Sand Dunes National Monument.

INTRODUCTION

Byron A. Alexander was a seasonal park naturalist at Great Sand Dunes National Monument in the late 1970's. It was here that his interest in entomology was inspired through his contact with Howard Evans and his students who were studying the behavior of wasps in and around the dunes. The illustrations of plant and insect life accompanying this inventory were created by Byron Alexander while he was working at the Monument, and are reproduced here with permission from Great Sand Dunes National Monument.

Great Sand Dunes National Monument is located in Alamosa and Saguache Counties in south central Colorado. The dunes, which cover 101 km² on the east side of the San Luis Valley, are pushed up against the Sangre de Cristo Mountains. Prevailing winds cross over the mountains to the northeast by way of two passes (Mosca Pass and Medano Pass) and deposit the sand load in dunes towering to more than 200 m above the valley floor. Less than 35 cm of precipitation fall on the dunes each year, and the water quickly percolates down from the surface. Daytime summer surface temperatures have been recorded in excess of 55 °C. At elevations above 2400 m, the Great Sand Dunes are also subject to cold winter temperatures and cool evening summer temperatures. Strong winds push sand across the surface and obscure most foot prints daily. The geology and hydrology of the dune mass is not fully understood and has been the subject of extensive research in recent years (for a review of the current knowledge of the geology, hydrology, biology, and anthropology of Great Sand Dunes National Monument, see Schenk, in press). Understanding the hydrology of the dunes has been crucial because of the recent threat of intense withdrawal of surface and ground water for agriculture and other consumptive uses (U.S. Bureau of Reclamation, 1987).

Plant life on the main dune mass is sparse, consisting principally of scurfpea, *Psoralidium lanceolatum* (Pursh) Rydberg (Fig. 1), Indian ricegrass, *Oryzopsis hymenoides* (Roemer and Schultes) Ricker (Fig. 2), blowout grass, *Redfieldia flexuosa* (Thurber) Vassey (Fig. 3), skeletonweed, *Lygodesmia juncea* (Pursh) Don (Fig. 4), and prairie sunflower, *Helianthus petiolaris* Nuttall (Fig. 5). Most of the plant life is clustered, forming vegetation "islands," mainly in the interdune areas.

Despite its seemingly barren landscape, Great Sand Dunes National Monument supports an abundance of arthropods. Several researchers have studied arthropods at the Monument, but no work has been done to combine the efforts of these endeavors into one comprehensive species list. We initiated this study in August 1990 to create an inventory of the arthropods known from the Great Sand Dunes.

The entomological collections of Great Sand Dunes National Monument (GRSA), the University of Colorado Museum in Boulder (UCM), and the C.P. Gillette Entomological Museum at Colorado State University in Fort Collins (CSU) contain numerous specimens previously collected within and around the Monument. These specimens were located, recorded, and identified as specifically as possible by taxonomic specialists. This cumulative collection exists thanks to the efforts of a number of researchers, including (specimen locations in parentheses): B. Rotger, 1942–1977 (UCM and published records in Rotger, 1944); T.P. Maslin, 1949 (UCM); R.E. Gregg, 1949–1954 (UCM, published records in Gregg, 1963); H.G. Rodeck, 1954–1955 (UCM); F.M. Brown, 1954–1981 (GRSA, UCM); H.E. and M.A. Evans, 1954–1983 (GRSA, CSU, and published records in Evans, 1966, and in Evans and O'Neill, 1988); J.C. Daniel et al., 1959 (GRSA); E.R. Tinkham, 1960 (published records in Tinkham, 1962); J. Brookhart, 1965 (UCM, published records in Brookhart, 1972); J. Stanatov,

¹ Department of Bioagricultural Sciences and Pest Management, Colorado State University, Fort Collins, CO 80523.

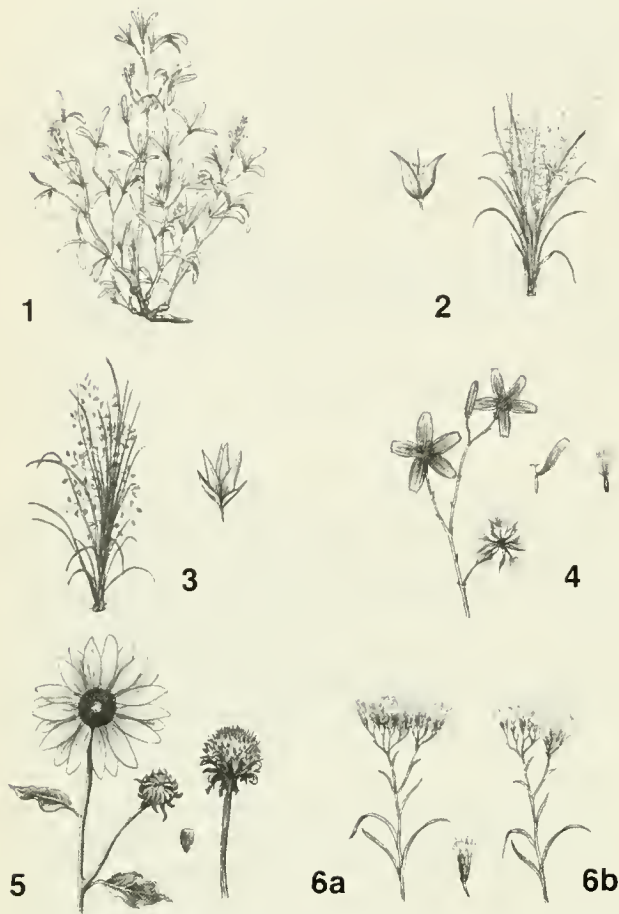

Figs. 1–6. 1–Scurfpea, *Psoralidium lanceolatum* (Pursh) Rydberg. 2–Indian ricegrass, *Oryzopsis hymenoides* (Roemer and Schultes) Ricker. Inset: Indian ricegrass flower. 3–Blowout grass, *Redfieldia flexuosa* (Thurber) Vassey. Inset: Blowout grass flower. 4–Skeletonweed, *Lygodesmia juncea* (Pursh) Don. Inset: Skeletonweed petal and fruit. 5–Prairie sunflower, *Helianthus petiolaris* Nuttall. Inset: Prairie sunflower seedhead and seed. 6–Rabbitbrush, *Chrysothamnus nauseosus* (Pallas) Britton. a: Rabbitbrush in bloom. b: Rabbitbrush in fruit. Inset: Rabbitbrush flower.

1971 (GRSA); P. Eades, 1974 (GRSA, CSU); C.A. Triplehorn, 1974 (published records in Triplehorn, 1964); K.M. O'Neill, 1974–1980 (GRSA, CSU, and published records in O'Neill, 1983a and 1983b, and O'Neill and Evans, 1981); W. Rubink, 1975 (GRSA, CSU); D. Gwynne, 1976–1979 (GRSA, CSU, and published records in Gwynne, 1978, 1980, and 1981; Gwynne and Evans, 1975; Gwynne and Hostetler, 1978; Gwynne and O'Neill, 1980; and Ahlbrandt et al., 1978); S. Condie, 1977 (GRSA, CSU); G.H. Kemper, 1977–1980 (GRSA, UCM); D. Huffman, 1978 (GRSA); S. Vertrees, 1978 (GRSA); W. Soenger, 1978–1980 (GRSA, CSU); B.A. Alexander, 1978–1995 (GRSA, CSU); S. Wingate, 1980 (GRSA); J. Crock, 1981 (CSU); L.D. Zuckerman, 1981–1982 (GRSA), T.P. Sluss, 1983 (GRSA and records in Sluss, 1986a and 1986b); M. Kippenhan, 1990 (CSU); W. Cranshaw, 1991 (CSU); D. & M. Leatherman, 1991 (CSU).

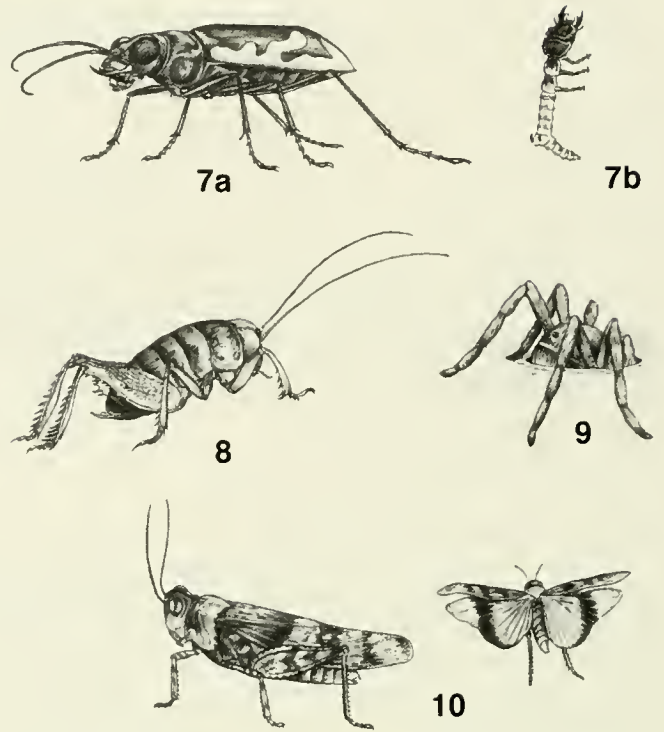

Figs. 7–10. 7–Great Sand Dunes tiger beetle, *Cicindela theatina* Rotger. a: Adult. b: Larva. 8–Giant sand treader cricket, *Daihimibaenetes giganteus* Tinkham. 9–Wolf spider, *Geolycosa rafaellana* Chamberlain. 10–Grasshopper, *Trimerotropis* sp. Inset: in flight.

Several species have been added to the inventory list based on collections from August 1990 through September 1995. Insects were sampled from several habitats in Great Sand Dunes National Monument. These included the open dune mass in several different areas, at different times of year, and during different times of the day and night. Many interdune areas, dominated by grass and scurfpea plants, were also sampled. Off the dunes, rabbitbrush, *Chrysothamnus nauseosus* (Pallas) Britton (Fig. 6), and other scrub zones were sampled, as was the area around the campground and in the piñon/juniper zones to the east (*Pinus edulis* Engelmann and *Juniperus communis* Linnaeus). Some sampling was also done at Denton Spring southeast of the dune mass and at Sand Creek on the west side of the Monument.

Collection techniques included sweep netting, black-light traps, and mercury-vapor lamps. All specimens collected or examined were recorded in two notebooks of data sheets, copies of which have been deposited at the museum at GRSA. All specimens collected during 1990–1995 have been catalogued into the National Park Service Automated National Catalog System (ANCS) and deposited at GRSA, CSU, or UCM.

The updated species list which follows is intended to provide baseline information on species diversity of the region. More than 900 species of arthropods have been recorded to date from the Monument. Among the new findings are four undescribed species. Two of these are anthicid beetles (*Amblyderus* n.spp.), which were found walking on the dunes at mid-day, with surface temperatures in excess of 40 °C. There is also a new robber fly (*Proctacanthus* n.sp.), among the largest insects in the Monument and distinctly different from two closely related species also recorded from the area. An undescribed species of geometrid moth (*Prochoerodes* n.sp.) has been found, also recorded from other places in the western U.S. but not yet formally described in the literature.

Unexpected records include a species of noctuid moth, *Schinia avemensis* (Dyar), previously known only from Manitoba, Canada, the caterpillar of which probably feeds on the flowerheads of the prairie sunflower, and a species of curtonotid fly, *Curtonotum helvum* (Loew), previously unknown west of the Mississippi River, collected at lights and on the *Cleome* flowers at Sand Creek.

The current species list represents only a small percentage, perhaps as little as 25%, of the total number of arthropods which occur within the Monument boundaries. Other sampling techniques, such as pit traps, Malaise traps, and Berlese funnels were not employed and would likely yield additional species. Additionally, historically there has been some bias in the collecting at the Monument. The large numbers of sphecid wasps and noctuid moths recorded are partially due to the habitat type, and partially due to collecting bias of previous researchers—Howard E. Evans, an authority on the behavior of sphecid wasps, and the late F. Martin Brown, a lepidopterist with a fondness for light trapping. Many of the smaller insects were likely overlooked, as were those with very short life cycles or that emerge for only a short time during the season.

Other major collections which are known to have specimens from the Monument include the American Museum of Natural History in New York, and the U.S. National Museum of Natural History (Smithsonian) in Washington, D.C. Both collections have moths (Paul A. Opler and F. Martin Brown, personal communications) which were not examined during this study.

Of special interest are the species that are apparently endemic to Great Sand Dunes National Monument and the San Luis Valley. This includes the darkling beetle ("circus beetle"), *Eleodes hirtipennis* Triplehorn; the Great Sand Dunes tiger beetle, *Cicindela theatina* Rotger (Fig. 7); and the two new species of anthicid beetles, *Amblyderus* spp., which are as yet undescribed and have not been found elsewhere to date. The giant sand treader cricket, *Daihinibaenetes giganteus* Tinkham (Fig. 8), once believed

to occur only at the Monument, has since been found in northern New Mexico and southern Utah (Theodore J. Cohn, personal communication).

All of the above species were seen regularly during the study and are therefore not considered locally rare. They are threatened only to the extent that they have a limited distribution. Their survival is probably dependent upon the survival of the dunes habitat itself. These species are good candidates for population monitoring to determine human impact on the dunes, or to monitor overuse of the resource. A drop in their population levels might indicate overuse of the Monument. Additionally, populations of the species in relatively isolated areas should be compared to populations in heavily used areas of the Monument. Further study is necessary to describe the natural history of these species.

The sand dunes at the Monument are a unique habitat. The dunes appear to be barren but actually are the habitat for a large number of resident insects. Almost one-fourth of the species recorded are considered residents of the sand and the grass/pea interdune areas. The others live in the surrounding vegetated areas, and may come to the sand for feeding or are blown onto the sand by the strong winds. With daytime summer surface temperatures surpassing 55 °C, the dunes are very inhospitable to insects that are not adapted to survive such temperatures. Insects blown onto the sand from other places usually die and are eaten by the scavengers. Many of the insects which are resident on the dunes, including the darkling beetles and sand treader crickets, are mainly scavengers and eat the dead and dying insects blown in from outside. There are also many sand mites which feed on the corpses. Predators such as the resident wolf spiders (*Geolycosa rafaellana* Chamberlain) (Fig. 9) and the tiger beetles also take advantage of the weakened insects, the spiders hunting by night and the tiger beetles by day. Primary production (from plants) is limited to the grass/scurfpea interdune areas. Herbivores, such as the plant bugs (*Lygus* spp.) and grasshoppers (*Trimerotropis* spp.) (Fig. 10), are generally restricted to these areas. Some additional information about the arthropods of the Monument is found in Weissmann et al. (1993).

ACKNOWLEDGMENTS

This research was made possible through the assistance of numerous individuals and institutions. Co-investigators on the research were Linda P. Clement (National Park Service) and Karolyn Darrow (University of Colorado Museum). Field assistance was provided by Judith Schaeffer, Dr. Edwin Licht, Dr. Boyce Drummond, and Rachel Williams. The staff of Great Sand Dunes National Monument, under the leadership of Superintendent Bill Wellman, provided valuable logistical support and lodg-

ing throughout this study. This research was funded in part by the Rocky Mountain Region of the National Park Service and a 1991 Colorado Natural History Small Grant from the Colorado Natural Areas Program of the Colorado Division of Parks and Outdoor Recreation (Project Number GRSA-R91-0145; Cooperative Agreement Number CA 1200-9-0004). Additional support was provided by a grant from the Orthopterists' Society Research Fund in 1994. The following specialists provided assistance with arthropod identifications: R.W. Brooks, J.M. Carpenter, S.M. Clark, T.J. Cohn, R. Davidson, B. Drummond, S. Elias, H.E. Evans, M.A. Evans, K. Hagen, D.J. Heffern, R.L. Hoffman, F.T. Hovore, M. Kippenhan, P.K. Lago, U.N. Lanham, D. Larson, E.L. Licht, W.N. Mathis, C.R. Nelson, G.H. Nelson, M.W. Nielson, P.A. Opler, R.S. Peigler, J.T. Polhemus, M.D. Schwartz, D.B. Thomas, C.A. Triplehorn, D. Weissman, J.L. Welch, and F. Werner.

SPECIES LIST^{2,3}

HEXAPODA

MICROCORYPHIA

Machilidae (unidentified)

EPHEMEROPTERA

Baetidae

Baetis tricaudatus Dodds

Heptageniidae

Cinygmula sp.*Epeorus longimanus* (Eaton)

Leptophlebiidae

Paraleptophlebia debilis (Walker)

Ephemerellidae

Ephemerella infrequens McDunnough

ODONATA

Aeshnidae

Aeshna constricta Say*Aeshna palmata* Hagen

Libellulidae

Sympetrum corruptum (Hagen)*Sympetrum occidentale* Bartenev

Lestidae

Lestes congener Hagen*Lestes dryas* Kirby*Lestes unguiculatus* Hagen

PHASMIDA

Heteronemiidae

Parabacillus coloradus (Scudder)

ORTHOPTERA

Acrididae

Acrolophitus hirtipes (Say)*Amphitornus coloradus* (Thomas)*Arphia pseudonietana* (Thomas)*Camnula pellucida* Scudder*Circotettix rabula rabula* Rehn and Hebard*Cordillacris occipitalis* (Thomas)*Cratypedes neglectus* (Thomas)*Dissosteira carolina* (Linnaeus)*Hadrotettix trifasciatus* (Say)*Hesperotettix speciosus* (Scudder)*Melanoplus bowditchi* Scudder*Melanoplus bowditchi canus* Hebard*Melanoplus femur-rubrum* (DeGeer)*Melanoplus packardii packardii* Scudder*Melanoplus* spp.*Mestobregma plattei corrugata* (Scudder)*Psoloessa delicatula* (Scudder)*Spharagemon campestris* (McNeill)*Spharagemon collaris* (Scudder)*Trimerotropis agrestis* McNeill*Trimerotropis cincta* (Thomas)*Trimerotropis fratercula* McNeill*Trimerotropis maritima* (Harris)*Trimerotropis verruculatus suffusa* Scudder*Xanthippus montanus* (Thomas)

Gryllidae

Oecanthus quadripunctatus Beutenmuller

Rhaphidophoridae

Ceuthophilus utahensis Thomas*Ceuthophilus* spp.*Dalhinibaenetes giganteus* Tinkham

Stenopelmatidae

Stenopelmatus sp.

Tettigoniidae

Anabrus simplex Haldeman*Conocephalus fasciatus* (DeGeer)

MANTODEA

Mantidae

Yersiniops solitarium (Scudder)

PLECOPTERA

Pteronarcyidae

Pteronarcella badia (Hagen)

Nemouridae

Malenka coloradensis (Banks)

Perlodidae

Isoperla quinquepunctata Banks

Chloroperlodidae

Plumiperla diversa (Frisson)*Sweltsa lamba* (Banks)

HEMIPTERA

Pentatomidae

Banasa sordida (Uhler)*Chlorochroa granulosa* Uhler*Chlorochroa sayi* (Stål)*Chlorochroa uhleri* (Stål)*Murgantia histrionica* (Hahn)*Perillus exaptus* (Say)

Scutelleridae

Amaurochrous cinctipes (Say)

(unidentified)

Cydniidae

Microporus obliquus Uhler

Coreidae

Chelinidea vittiger Uhler*Leptoglossus clypealis* Heidemann*Leptoglossus occidentalis* Heidemann

Alydidae

Alydus pluto Uhler*Alydus* spp.*Megalotomus quinquespinosus* (Say)

Rhopalidae

Harmostes sp.*Liorhyssus* sp.

(unidentified)

Lygaeidae

Lygaeus relictus Say*Neocoryphus lateralis* (Say)*Nysius* sp.*Peritrechus fraternus* Uhler ?*Xyonyssius* c.f. *californicus* Stål² Apparently endemic species = ***³ Species names in brackets [] are questionable records (no specimen available) or recorded from just outside the Monument boundary but not specifically within the Monument.

Phymatidae	
<i>Phymata</i> sp.	
Reduviidae	
<i>Ariilus cristatus</i> Linnaeus	
<i>Fitchia aptera</i> Stål	
<i>Sinea diadema</i> (Fabricius)	
Nabidae	
<i>Nabis</i> sp.	
Miridae	
<i>Atractotomus striacolor</i> (Knight)	
<i>Hadronema picta</i> Uhler ?	
<i>Ilnacora chloris</i> (Uhler)	
<i>Litomiris debilis</i> (Uhler)	
<i>Lopidea</i> sp.	
<i>Lygidea rubecula</i> (Uhler)	
<i>Lygus atriflavus</i> Knight	
<i>Lygus elisus</i> VanDuzee	
<i>Lygus lineolaris</i> (Palisot)	
<i>Lygus nubilatus</i> Knight	
<i>Lygus shulli</i> Knight	
<i>Orthotylus viridis</i> VanDuzee	
<i>Phytocoris comulus</i> Knight	
<i>Phytocoris consors</i> VanDuzee	
<i>Phytocoris heidemanni</i> Reuter	
<i>Phytocoris inops</i> Uhler	
<i>Phytocoris simulatus</i> Knight	
<i>Phytocoris validus</i> Reuter	
<i>Polymerus balli</i> Knight	
<i>Stenodema pilosipes</i> Kelton	
<i>Tupiocoris agilis</i> (Uhler) ?	
Gerridae (unidentified)	
Corixidae	
<i>Cenocorixa</i> sp.	
<i>Graptocorixa abdominalis</i> (Say)	
<i>Sigara alternata</i> (Say)	
Notonectidae	
<i>Notonecta kirbyi</i> Hungerford	
<i>Notonecta undulata</i> Say	
HOMOPTERA	
Aphididae (unidentified)	
Delphacidae (unidentified)	
Membracidae	
<i>Publilia modesta</i> Uhler	
(unidentified)	
Cicadellidae	
<i>Aceratogallia arida</i> Oman	
<i>Aceratogallia uhleri</i> (VanDuzee)	
<i>Aceratogallia</i> sp.	
<i>Athysanella occidentalis</i> Baker	
<i>Idiocerus snowi</i> Gillette and Baker	
<i>Kybos</i> sp.	
<i>Laevicephalus parvulus</i> (Gillette)	
<i>Oncometopia lateralis</i> Fabricius	
(unidentified)	
Dictyopharidae	
<i>Scolops</i> sp.	
NEUROPTERA	
Myrmeleontidae	
<i>Brachynemurus nigrilabris</i> Hagen	
<i>Brachynemurus peregrinus</i> (Hagen)	
<i>Brachynemurus sackeni</i> (Hagen)	
<i>Myrmeleon immaculatus</i> DeGeer	
Chrysopidae	
<i>Chrysopa coloradensis</i> Banks	
<i>Chrysopa oculata</i> Say	
<i>Chrysoperla</i> sp.	
<i>Eremochrysa</i> sp.	
Hemerobiidae	
<i>Hemerobius</i> sp.	
<i>Micromus</i> sp.	
	Raphidiidae
	<i>Raphidia</i> sp.
	COLEOPTERA
	Carabidae
	<i>Agonum placidum</i> (Say)
	<i>Amara impuncticollis</i> Say
	<i>Bembidion graphicum</i> Casey
	<i>Calosoma obsoletum</i> Say
	<i>Elaphrus lecontei</i> Crotch
	<i>Euryderus grossus</i> (Say)
	<i>Geopinus incrassatus</i> (Dejean)
	<i>Harpalus amputatus</i> Say
	<i>Harpalus erraticus</i> Say
	<i>Harpalus paratus</i> Casey
	<i>Harpalus</i> spp.
	<i>Omophron tessellatum</i> Say
	Cicindelidae
	<i>Cicindela formosa</i> Say
	<i>Cicindela hirticollis shelfordi</i> Graves
	<i>Cicindela lengi</i> Horn
	<i>Cicindela oregona guttifera</i> LeConte
	<i>Cicindela punctulata</i> Olivier
	<i>Cicindela repanda</i> Dejean
	*** <i>Cicindela theatina</i> Rotger
	Dytiscidae
	<i>Agabus lutosus</i> LeConte
	<i>Colymbetes exaratus incognitus</i> LeConte
	<i>Dytiscus</i> sp.
	<i>Graphoderes occidentalis</i> Horn
	<i>Hydroporus</i> sp. (<i>vilis</i> complex)
	<i>Hygrotus impressopunctatus</i> (Schaller)
	<i>Hygrotus infuscatus</i> (Sharp)
	<i>Hygrotus masculinus</i> (Crotch)
	<i>Hygrotus tumidiventris</i> (Fall)
	<i>Hygrotus</i> sp.
	<i>Ilybius fraterculus</i> LeConte
	<i>Laccophilus maculosus decipiens</i> LeConte
	<i>Liodessus obscurellus</i> (LeConte)
	<i>Stictotarsus striatellus</i> (LeConte)
	<i>Rhantus</i> sp.
	Gyrinidae
	<i>Gyrinus</i> sp.
	Hydrophilidae
	<i>Cercyon</i> sp.
	<i>Hydrochus</i> sp.
	<i>Sphaeridium scarabaeoides</i> (Linnaeus)
	<i>Tropisternus</i> sp.
	Histeridae
	<i>Hypocaccus</i> n.sp.
	<i>Saprinus lugens</i> Erichson
	<i>Spilodiscus</i> sp.
	(unidentified)
	Staphylinidae
	<i>Alcochara bimaculata</i> (Gravenhorst)
	<i>Creophilus maxillosus</i> Linnaeus
	Silphidae
	<i>Heterosilpha ramosa</i> (Say)
	<i>Nicrophorus guttula</i> Motschulsky
	<i>Nicrophorus marginatus</i> Fabricius
	Lucanidae
	<i>Pseudolucanus mazama</i> LeConte
	Scarabaeidae
	<i>Aphodius</i> sp.
	<i>Diplotaxis belfragei</i> Fall
	<i>Eucanthus impressus</i> Howden
	<i>Glaresis ecostata</i> Fall
	<i>Ligyris gibbosus</i> (DeGeer)
	<i>Phyllophaga fimbripes</i> (LeConte)
	<i>Phyllophaga</i> sp.
	<i>Polyphylla decimlineata</i> (Say)

- Serica alternata* LeConte
Serica bruneri Dawson
Serica procula Casey
Serica sp. (prob. *anthracina* LeConte)
Trichotinus assimilis (Kirby)
Trox sonorae LeConte
- Dryopidae
Helichus striatus LeConte
- Elmidae
Heterlimnius corpulenta (LeConte)
Optioservus divergens (LeConte)
- Buprestidae
Dicerca tenebrica (Kirby)
Melanophila gentilis LeConte
- Lampyridae (unidentified)
- Cantharidae
Chauliognathus scutellaris LeConte
- Dermestidae
Trogoderma sp. (prob. *angustum* (Solier))
 (unidentified)
- Cleridae
Enoclerus moestus (Klug)
Phyllobaenus sp.
Trichodes ornatus ornatus Say
- Melyridae
Collops bipunctatus Say
 (unidentified)
- Nitidulidae
Carpophilus sp.
- Phalacridae
Phalacrus sp.
- Coccinellidae
Anatis lecontei Casey
Coccinella monticola Mulsant
Coccinella septempunctata Linnaeus
Coccinella transversoguttata richardsoni Brown
Hippodamia caseyi Johnson
Hippodamia convergens Guerin-Meneville
Hippodamia quinquesignata (Kirby)
Hippodamia tredecimpunctata tribalis (Say)
Myzia interrupta (Casey)
- Tenebrionidae
Bothrotes plumbeus (LeConte)
Contontis obesa LeConte
Eleodes acuticaudus LeConte
Eleodes brunripes Casey
Eleodes caudiferus LeConte
Eleodes extricatus (Say)
 ****Eleodes hirtipennis* Triplehorn
Eleodes longicollis LeConte
Eleodes obscurus dispersus LeConte
Eleodes pimelioides Mannerheim
Eleodes snowi Blaisdell
Eleodes sponsus LeConte
Eleodes tricostatus (Say)
Embaphion contusum LeConte
Embaphion glabrum Blaisdell
Eusattus reticulatus Say
Helops sp.
Telabis aspera Casey
- Mordellidae (unidentified)
- Meloidae
Epicauta sp.
Lytta muttalli (Say)
Nemognatha sp.
Pyrota bilineata Horn
Tricrania stansburyi Haldeman
 (unidentified)
- Anthicidae
 ****Amblyderus* n.sp.1
 ****Amblyderus* n.sp.2
- Anthicus lutulentus* Casey
Anthicus sp.
Notoxus sp.
- Cerambycidae
Anoplodera canadensis (Olivier)
Arhopalus rusticus montanus (LeConte)
Batyle ignicollis (Say)
Batyle suturalis pearsalli (Bland)
Cortodera longicornis (Kirby)
Crossidius coralinus jocosus (Horn)
Crossidius hirtipes wickhami Casey
Crossidius pulchellus (LeConte)
Grammoptera subargentata (Kirby)
Monilema appressum LeConte
Monochamus clamator (LeConte)
Monochamus scutellatus (Say)
Pachyta lamed liturata Kirby
Prionus californicus Motschulsky
Prionus emarginatus Say
Prionus integer LeConte
Typocerus balteatus Horn
Xylotrechus undulatus (Say)
- Chrysomelidae
Altica bimarginata Say
Altica sp.
Cryptocephalus spp.
Disonycha alternata (Illiger)
Disonycha latifrons Schaeffer
Disonycha sp.
Galeruca costatissima Blake ?
Macrohaltica sp.
Microhopala excavata cyanea (Say)
Pachybrachis sp.
Phyllotreta spp.
Saxinis saucia LeConte
Tricholochamaea sp. ?
Trirhabda lewisii Crotch
Trirhabda nitidicollis LeConte
Zygogramma conjuncta Rogers
- Curculionidae
Epimechus sp.
 (unidentified)
- TRICHOPTERA
- Hydropsychidae
Arctopsyche grandis Banks
Cheumatopsyche sp.
- Glossosomatidae
Agapetus boulderensis Milne
Glossosoma sp.
- Hydroptilidae
Hydroptila sp.
- Rhyacophilidae
Rhyacophila coloradensis Banks
- Brachycentridae
Brachycentrus americanus (Banks)
- Limnephilidae
Limnephilus sp.
- LEPIDOPTERA
- Oecophoridae
Agonopterix sp. ?
- Gelechiidae (unidentified)
- Tortricidae
Acleris sp. ?
Argyrotaenia coloradana (Fernald)
Dorithia semicircularana (Fernald)
Eucosma crambitana Walsingham
Eucosma fernaldana (Grote)
Eucosma nr. *ridingsana* (Robinson)
Eucosma sp.
Syndemis sp. [or *Pandemis* sp.]
Xenotemna pallorana (Robinson)

- Hesperiidae
Erymnis icelus (Scudder and Burgess)
Hesperia comma colorado (Scudder) ?
Hesperia comma ochracea Lindsey
Hesperia nevada (Scudder)
Hesperia uncas Edwards
Oarisma garita (Reakirt)
Pyrgus communis (Grote)
Pyrgus xanthus Edwards
Yvretta thesus (Edwards)
- Papilionidae
Papilio rutulus (Linnaeus)
Parnassius phoebus pseudorotgeri Edwards
- Pieridae
Artogeia rapae (Linnaeus)
Colias eurytheme Boisduval
Eurema nicippe (Cramer)
Neophasia menapia (Felder and Felder)
Pontia beckerii (Edwards)
Pontia protodice (Boisduval and LeConte)
- Lycaenidae
Agriades franklinii rusticus (Edwards)
Callophrys apama homoperplexa Barnes and Benjamin
Celestrina ladon cinerea (Edwards)
Chalceria rubida sirius (Edwards)
Euphilotes rita coloradensis (Mattoni)
Hemiargus isola alce (Edwards)
Icaricia acmon lutzii dos Passos
Icaricia icarioides lycea (Edwards)
Incisalia niphon niphon (Hübner)
Leptotes marina (Reakirt)
Lycaeides melissa melissa (Edwards)
Mitoura siva siva (Edwards)
Satyrium behrii crossi (Field)
Strymon melinus franki Field
Tharsalea arota schellbachi Tilden
- Riodinidae
Apodemia mormo mormo Felder and Felder
- Nymphalidae
Basilarchia weidemeyeri weidemeyeri (Edwards)
Charidryas acastus (Edwards)
Euptoieta claudia (Cramer)
Nymphalis antiopa (Linnaeus)
Phyciodes campestris camillus Edwards
Poladryas arachne arachne (Edwards)
Polygonia hylas (Edwards)
Speyeria aphrodite ethne (Hemming)
[Vanessa atalanta atalanta (Linnaeus)]
Vanessa cardui (Linnaeus)
- Satyridae
Cercyonis meadii alamosa Emmel and Emmel
Cercyonis oetus charon (Edwards)
Coenonympha ochracea Edwards
Cyllopsis pertepida dorothea (Nabokov)
Neominois ridingsii ridingsii (Edwards)
Oeneis chryxus chryxus (Doubleday and Hewitson)
- Danaidae
Danaus gilippus Cramer
Danaus plexippus (Linnaeus)
- Pyralidae (unidentified)
- Geometridae
Caripeta aequaliaria Grote
Caripeta interalbicans Warren
Cheteoscelis bistrifaria (Packard)
Chlorosea nevadaria Packard
Enypia grisata Grossbeck
Eriplatymetra coloradaria (Grote and Robinson)
Eupithecia anticaria Walker
Hydriomena morosata Barnes and McDunnough
Hydriomena perfracta centralis McDunnough
Hydriomena similis Hulst
Iridopsis emasculata (Dyar)
Itame bitactata (Walker)
Itame decorata (Hulst)
Itame flavicaria (Packard)
Metanema inatomaria Guenee
Perizoma custodiata (Guenee)
Pero behrensaria (Packard)
Plataea trilinearia (Packard)
Prionomelia spododea (Hulst)
Prochoerodes forficaria (Guenee)
Prochoerodes truxaliata (Guenee)
Prochoerodes n.sp. Inr. amplicineraria (Pearsall)]
Scelidacantha triseriata (Packard)
Semiolitha nubiculata (Packard)
Semiolitha subminiata (Packard)
Semiolitha sp.
Stannoctentis morrisata (Hulst)
Stannodes formosata (Strecker)
Synchlora aerata liquoraria Guenee
- Lasiocampidae
Epicnaptera americana (Harris)
Gloveria arizonensis Packard
Malacosoma californica Packard
- Saturniidae
Antheraea polyphemus (Cramer)
Coloradia doris Barnes
Hemileuca nuttalli (Strecker)
Hyalophora gloveri (Strecker)
- Sphingidae
Hemaris senta (Strecker)
Hyles lineata (Fabricius)
Smerinthus cerisyi Kirby
Sphinx dollii Neumoegen
- Arctiidae
Eilema bicolor Grote
Lophocampa ingens (Edwards)
Lophocampa maculata Harris
Turipitana permaculata (Packard)
- Lymantriidae
Dasychira sp. ?
- Noctuidae
Abagrotis discoidalis (Grote)
Abagrotis reedi Buckett
Agroperina conradi (Grote)
Agrotis ipsilon (Hufnagel)
Anathix aggressa (Smith)
Andropolia diversilineata (Grote)
Apanca occidens (Grote)
Aseptis fumosa (Grote)
Brachylomia populi (Strecker)
Catocala grotiana Bailey
Catocala hermia Edwards
Copablepharon absidum (Harvey)
Copablepharon grande (Strecker)
Copablepharon sp.
Crassivesica bocha (Morrison)
Crymodes devastator (Brace)
Cucullia sp.
Drasteria mirifica klotsi Richards
[Euargia decolor (Walker)]
Euargia infumata (Grote)
Eurois praefixa (Morrison)
Euxoa albipennis (Grote)
Euxoa aurulenta (Smith)
Euxoa auxiliaris (Grote)
Euxoa brevipennis Smith
Euxoa cicatricosa (Grote and Robinson)
Euxoa divergens (Walker)
Euxoa messoria (Harris)
Euxoa mimallonis (Grote)

- Euxoa moerens* (Grote) ?
Euxoa obeliscoides (Guenee)
Euxoa oblongistigma (Smith) ? [or *olivalis* (Grote)]
Euxoa quadridentata (Grote and Robinson)
Euxoa ridingsiana (Grote)
Euxoa scandens (Riley)
Euxoa stigmatalis (Smith)
Euxoa tessellata (Harris) ?
Euxoa sp.
Helicoverpa zea (Boddie)
Hemieuxoa rudens (Harvey)
Homohadena fifia Dyar
Lacanobia lilacina (Harvey)
Lacinipolia naevia (Smith)
Lacinipolia olivacea megarena (Smith)
Lacinipolia umbrosa (Smith)
Lacinipolia vicina (Grote)
Lacinipolia sp.
Litholomia napaea (Morrison)
Oligia sp.
Oncocnemis balteata Smith
Oncocnemis colorado Smith
Oncocnemis hayesi Grote
Oncocnemis homogena Grote
Oncocnemis iricolor Smith
Peridroma saucia (Hubner)
Platyperigea camina Smith
Platyperigea extima (Walker)
Platyperigea meralis (Morrison)
Ponometia sutrix (Grote)
[Protagrotis niveivenosa (Grote)]
Protogygia sp.
Protorthodes utahensis (Smith)
Protorthodes sp. (prob. *akalus* Strecker)
Pseudanarta caeca Dod
Pseudanarta flavidens (Grote)
Pseudanarta perplexa Franclemont
Pseudanarta sp.
Raphia coloradensis Putnam-Cramer ?
Richia parentalis (Grote)
Schinia avemensis (Dyar)
Schinia balba brucei Smith
Schinia nr. citrinella (Grote and Robinson)
Schinia meadi (Grote)
Schinia unimacula Smith
Schinia sp.
Scoliopteryx libatrix (Linnaeus)
Stiria rugifrons Grote
Synedoida inepta Edwards
Trichocerapoda oblita (Grote)
Trichocerapoda strigata (Smith)
(unidentified)
- DIPTERA
- Tipulidae
Dicranota sp.
Hexatoma sp.
Tipula sp.
- Bibionidae
Biblio femorata Wiedeman
- Mycetophilidae (unidentified)
- Sciaridae (unidentified)
- Cecidomyiidae
Rhabdophaga strobiloides (Osten Sacken)
Rhopalomyia chrysothamni Felt
- Scatopsidae
Aspistes sp.
- Culicidae
Aedes malanimon Dyar
Aedes sp.
Culex tarsalis Coquillett
Culiseta inornata (Williston)
- Simuliidae
Simulium sp.
(unidentified)
- Chironomidae (unidentified)
- Tabanidae
Chrysops sp.
- Rhagionidae
Symphoromyia sp.
- Stratiomyidae
Nemotelus sp.
Saragus cuprarius (Linnaeus)
- Therevidae
Acrosathe sp.
Ozodiceromyia sp.
Pherocera sp. ?
Psilocephala sp. (nr. *lateralis* Adams)
Thereva sp.
- Asilidae
Ablautus rufotibialis Back
Asilus formosus Hine
Cyrtopogon plausor Osten Sacken
Efferia frewingi Wilcox
Efferia jubata (Williston)
Efferia rapax (Osten Sacken)
Efferia staminea (Williston)
Efferia varipes (Williston)
Efferia sp. (prob. *subcuprea* (Schaeffer))
Eucyrtopogon sp.
Laphria sp.
Lasiopogon quadrivittatus James
Lasiopogon sp.
Machimus adjustus Martin
Machimus occidentalis (Hine) ?
Proctacanthella cacopiloga (Hine)
Proctacanthus micans Shiner
Proctacanthus milberti Macquart
****Proctacanthus* n.sp.
Promachus nigripes Hine
Promachus sp. (prob. *albifacies* Williston)
Stenopogon coyote Bromley
Stenopogon engelhardti Bromley
Stenopogon indistinctus (Bromley)
Stenopogon inquinatus Loew
Stenopogon martini Bromley
Stenopogon sp.
Stichopogon argenteus (Say)
Stichopogon trifasciatus (Say)
- Bombyliidae
Apolysis sp.
Dipalta serpentina Osten Sacken
Exoprosopa spp.
Hemipenthes sp.
Oligodranes sp.
Paravilla sp., nr. *fulviana* (Say)
Phthiria sp.
Thevenemyia sp.
Villa sp., nr. *lateralis* (Say)
Villa sp.
- Empididae
Platypalpus sp.
(unidentified)
- Phoridae (unidentified)
- Syrphidae
Allograpta obliqua (Say)
Baccha lemus Osten Sacken
Chrysogaster parva Shannon
Crioprora femorata Williston
Eristalis hirtus Loew
Eristalis latifrons Loew
Eristalis tenax (Linnaeus)
Eupeodes volucris Osten Sacken

- Helophilus latifrons* Loew
Melanostoma stegnum Say
Paragus bicolor (Fabricius)
Paragus tibialis (Fall)
Paragus variabilis Vockeroth
Scaeva pyrastris Linnaeus
Sphaerophoria cylindrica (Say)
Sphaerophoria philanthus (Meigen)
Spilomyia interrupta Williston
Toxomerus marginatus (Say)
Volucella satura Osten Sacken
Xylota sp. ?
- Pipunculidae
Tomosvaryella sp.
- Conopidae
Physocephala texana (Williston)
Zodion fulvifrons Say
- Micropezidae
Micropeza turcana Townsend
- Otitidae
Ceroxys laticulus (Loew)
Oedopa ascriptiva Hendel
Otites sp.
- Pyrgotidae
Sphecomyiella valida (Harris)
- Tephritidae
Tephritis sp.
- Agromyzidae
Agromyza sp.
 (unidentified)
- Sepsidae
Sepsis sp.
- Sciomyzidae
Limnia sp.
- Lauxaniidae
Camptoprosopella dolorosa Williston
Homoneura sp.
- Chamaemyiidae
Chamaemyia sp.
Leucopis sp.
- Curtonotidae
Curtonotum helvum (Loew)
- Ephydriidae (unidentified)
- Chloropidae
Chlorops sp.
Meromyza sp.
- Heleomyzidae
Pseudoleria sp.
Suillia sp.
- Anthomyiidae (unidentified)
- Muscidae
Fannia sp.
 (unidentified)
- Calliphoridae
Lucilia sericata (Meigen)
Phormia regina (Meigen)
Protophormia terracnovae (Robineau-Desvoidy)
- Sarcophagidae
Eumacronychia sp., nr. *elita* Townsend
Metoposarcophaga pachyproctosa (Parker)
Phrosinella fulvicornis (Coquillett)
Ravina lherminieri (Robineau-Desvoidy)
Sarcophaga aldrichi Parker
Senotainia sp., nr. *trilineata* (Wulp)
Senotainia spp.
Wohlfahrtia vigil Walker
- Tachinidae
Acroglossa hesperidarum (Williston)
Archytas sp.
Clairvillia sp. ?
Cylindromyia armata Aldrich
Cylindromyia spp.
Deopalpus sp.
Epalpus sp. (prob. *signifer* (Walker))
Frontiniella parancilla Townsend ?
Gonia spp.
Juriniopsis sp.
Leucostoma sp. ?
Linnaemya sp.
Microchaetina sp.
Parachytas sp.
Peleteria aldrichi Curran
Peleteria spp.
Phasia sp.
Ptilodexia agilis Rein
Ptilodexia sp.
Spallanzania sp.
Tachina sp. ?
 (unidentified)
- Oestridae
Cuterebra approximata Walker
- HYMENOPTERA
- Braconidae
Apanteles spp.
Cremmops sp.
Iphiaulax sp.
Rogas sp.
 (unidentified)
- Ichneumonidae
Anomalon reticulatum (Cresson)
Enicospilus sp.
Exochus sp.
Glypta sp.
Megarhyssa sp.
Netelia sp.
Ophion sp.
 (unidentified)
- Mymaridae (unidentified)
- Eulophidae
Entedon sp.
 (unidentified)
- Encyrtidae (unidentified)
- Eupelmidae (unidentified)
- Torymidae
Torymus koebeli Hubner
Torymus nr. *tubularis* Hubner
- Pteromalidae
Pteromalus sp.
- Eurytomidae (unidentified)
 (unidentified family of Proctotrupeoidea)
- Chalcididae
Spilochalcis arcana (Cresson)
- Chrysididae
Ceratochrysis kansensis (Viereck)
Chrysis coeruleans Fabricius
Chrysis dorsalis Aaron
Chrysis scitula Cresson
Hedychridium nevadae Kimsey
Hedychridium nigropilosum Mocsary
- Bethylidae
Epyris clarimontis Kieffer
Epyris myrmecophilus Brues
- Sphecidae
Ammophila azteca Cameron
Ammophila harti Fernald
Ammophila juncea Cresson
Ammophila macra Cresson
Ammophila procera Dahlbom
Ammophila strenua Cresson
Ammoplanops sp.
Ancistromma aurantia (Fox)
Ancistromma capax (Fox)

Aphilanthops frigidus (Smith)
Bembecinus quiquespinosus (Say)
Bembix americana spinolae Lepeltier
Bembix pruinosa Fox
Bembix sayi Cresson
Bicyrtes centralis Say
Bothynostethus distinctus Fox
Cerceris bicornuta bicornuta Guerin
Cerceris conifrons Mickel
Cerceris echo Mickel
Cerceris rhois Rohwer
Cerceris sexta Say
Cerceris tepanica Saussure
Cerceris wyomingensis Scullen
Cerceris sp.
Clypeadon laticinctus Cresson
Crabro florissantensis Rohwer
Crabro pallidus Fox
Crossocerus sp.
Diodontus occidentalis Fox
Diodontus rugosus Fox
Dryudella caerulea (Cresson)
Dryudella rhimpa Parker
Ectemnius dilectus Cresson
Ectemnius sp.
Encopognathus wenonah (Banks)
Eucerceris fulvipes Cresson
Eucerceris superba superba Cresson
Eucerceris zonata (Say)
Gorytes canaliculatus Packard
Hoplisoides placidus birkmanni Baker
Hoplisoides spilopterus (Handlirsh)
Hoplisoides sp.
Larropsis uniformis Bohart and Bohart
Larropsis vegeta (Fox)
Larropsis sp.
Mellinus abdominalis Cresson
Microbembex californica Bohart
Microbembex monodonta Say
Mimesa sp.
Miscophus sp.
Oryttus gracilis arapaho (Pate)
Oryttus sp.
Oxybelus emarginatum Say
Oxybelus parvum Cresson
Oxybelus uniglumis quadrinotatus Say
Palmodes carbo Bohart and Menke
Philanthus albopilosus Cresson
Philanthus basilaris Cresson
Philanthus bicinctus Mickel
Philanthus inversus Patton
Philanthus psyche Dunning
Philanthus pulcher Dalla Torre
Philanthus zebratus Cresson
Plenocilus davisii Fox
Plenocilus propinquus Fox
Plenocilus sp.
Podalonia communis (Cresson)
Podalonia luctuosa (Smith)
Podalonia mexicana (Saussure)
Podalonia mickeli Murray
Podalonia occidentalis Murray
Podalonia robusta Cresson
Prionyx canadensis (Provancher)
Prionyx parkeri Bohart and Menke
Prionyx thomae (Fabricius)
Pseudoplisus venustus (Cresson) ?
Pulverro sp.
Steniolia obliqua (Cresson)
Stictiella plana Fox
Tachysphex quebecensis (Provancher)

Tachysphex sp.
Tachytes spatulatus Fox
Tachytes spp.

Colletidae

Colletes albescens Cresson
Colletes americanus Cresson
Colletes gypsicolens Cockerell
Colletes lutzi lutzi Timberlake
Colletes phaceliae Cockerell
Colletes simulans Cresson
Colletes sp.
Hylaeus sp.

Andrenidae

Andrena andrenoides Cresson
Andrena barbilabris Kirby
Andrena birtuelli Cockerell
Andrena colletina Cockerell
Andrena cupreotincta Cockerell
Andrena helianthi Robertson
Andrena hitei Cockerell
Andrena illinoiensis Robertson
Andrena lupinorum Cockerell
Andrena medionitens Cockerell
Andrena mentzeliae Cockerell
Andrena placida Smith
Andrena prunorum Cockerell
Andrena vulpicolor Cockerell
Perdita fallax Cockerell
Perdita hyalina Cresson
Perdita nigroclypeata Timberlake
Perdita sp.
Pseudopanurgus sp.

Halictidae

Agapostemon angelicus Cockerell ?
Agapostemon femoratus Crawford
Agapostemon splendens (Lepeletier)
Agapostemon texanus Cresson ?
Dialictus albobirtus (Crawford)
Dialictus pictus (Crawford)
Dialictus pruinosiformis (Crawford)
Dialictus pruinosus (Robertson)
Dialictus ruidosensis Cockerell
Dialictus scrophulariae (Cockerell)
Dialictus succinipennis (Ellis)
Evylnus cooleyi (Crawford)
Evylnus lusorius (Cresson)
Halictus sp.
Lasioglossum cyaneiceps (Cockerell)
Lasioglossum sisymbrii (Cockerell)
Lasioglossum trizonatum (Cresson)
Nomia heteropoda kirbii Smith
Sphécodes sp.

Megachilidae

Anthidium emarginatum Say ?
Anthidium rodecki Schwarz
Anthidium tenuiflorae Cockerell
Anthidium sp.
Ashmeadiella californica (Ashmead)
Ashmeadiella sp.
Dianthidium ulkei (Cresson)
Dianthidium sp.
Heriades gracilior Cockerell
Heriades sp.
Hoplitis albifrons (Kirby)
Lithurge apicalis (Cresson)
Megachile addenda Cresson
Megachile fidelis Cresson
Megachile fortis Cresson
Megachile nevadensis Cresson
Megachile perihirta Cockerell ?
Megachile pugnata Say

- Osmia atriventris* Cresson ?
Osmia lignaria propinqua Cresson
Trachusa occidentale (Cresson)
Trachusa zebratum (Cresson) ?
- Anthophoridae**
Anthophora curta Provancher
Anthophora montana Cresson
Anthophora sp.
Ceratina neomexicana Cockerell
Ceratina nanula Cockerell ?
Diadasia sp.
Epeolus lutzii Cockerell ?
Epeolus pusillus Cresson
Habropoda cineraria (Smith)
Habropoda morrisoni (Cresson)
Melecta pacifica Cresson
Melissodes sp.
Nomada vineta Say
Xenoglossodes sp.
Xeromelecta californica Cresson
- Apidae**
Apis mellifera Linnaeus
Bombus appositus Cresson
Bombus bifarius Cresson
Bombus centralis Cresson
Bombus fervidus (Fabricius)
Bombus flavifrons Cresson
Bombus huntii Greene
Bombus mixtus Cresson
Bombus morrisoni Cresson
Bombus nevadensis nevadensis Cresson
Bombus terricola occidentalis Greene
Psithyrus insularis (Smith)
- Tiphiidae**
Brachycystis glabrella (Cresson)
Neotiphia sulcata (Roberts)
Paratiphia sp.
Tiphia nona Allen ?
Tiphia sp.
- Mutillidae**
Chyphotes albipes Cresson
Dasymutilla bioculata (Cresson)
Dasymutilla chiron ursula (Cresson)
Dasymutilla medea (Cresson)
Dasymutilla nigripes (Fabricius)
Dasymutilla vesta (Cresson)
Dasymutilla vestita (Lepeltier)
Odontophotopsis obliquus Viereck
Odontophotopsis ocellatus Baker ?
Odontophotopsis sp.
Photopsis clara Cresson ?
Pseudomethoca propinqua (Cresson)
- Pompilidae**
Anoplius brevihirta (Banks)
Anoplius marginalis (Banks)
Aporinellus completus Banks
Cryptocheilus terminatum terminatum Say
Episyron quinquenotatus hundi Evans
Evagetes ingenuus (Cresson)
Evagetes padrinus minisculus (Banks)
Pompilus scelestus Cresson
- Scoliidae**
Campsomeris pilipes Saussure
Campsomeris plumipes confluenta Say
- Masaridae**
Pseudomasaris vespoidea (Cresson)
- Vespidae**
Vespula arenaria Fabricius
Vespula atropilosa Sladen
Vespula maculata Linnaeus
Vespula norvegicoides Sladen
Vespula pennsylvanica Saussure
- Eumenidae**
Ancistrocerus adiabatus adiabatus (Saussure)
Ancistrocerus antilope antilope (Panzer)
Ancistrocerus bustemente bustemente (Saussure)
Ancistrocerus catskill (Saussure)
Ancistrocerus catskill albophaleratus (Saussure)
Ancistrocerus durangoensis Cameron
Ancistrocerus lineativentris lineativentris Cameron
Eumenes crucifera crucifera Provancher
Eumenes verticalis coloradensis Cresson
Euodynerus auratus albivestis Bohart
Euodynerus auratus auratus (Cameron)
Euodynerus foraminatus aequalis (Cameron)
Euodynerus nr. *tempifera* (Viereck)
- Formicidae**
Camponotus pennsylvanicus modoc Wheeler
Camponotus vicinus Mayr
Dorymyrmex pyramicus (Roger)
Formica bradleyi Wheeler
Formica fusca Linnaeus
Formica integroides coloradensis Wheeler
Formica neoclara Emery
Formica obscuripes Forel
Lasius alienus americanus Emery
Manica mutica (Emery)
Monomorium minimum (Buckley)
Myrmica brevispinosa Wheeler
Myrmica brevispinosa discontinua Weber
Pheidole pilifera coloradensis Emery
Pogonomyrmex occidentalis (Cresson)
Tapinoma sessile (Say)
- ARACHNIDA**
ARANEAE
Dictynidae (unidentified)
Araneidae (unidentified)
Tetragnathidae
Tetragnatha sp.
Lycosidae
Geolycosa rafaellana Chamberlain
Lycosa sp.
Thomisidae (unidentified)
Salticidae (unidentified)
- ACARI**
Erythraeidae (unidentified)
(unidentified)
- PSEUDOSCORPIONES** (unidentified)
SOLIFUGAE
Eremobatidae
Eremobates mormonus Muma
Eremochelis bilobatus Muma
Hemerotrecha fruitana Muma
- LITERATURE CITED**
- Ahlbrandt, T. S., S. Andrews, and D. T. Gwynne. 1978. Bioturbation in eolian deposits. *Journal of Sedimentary Petrology* 48: 839-848.
- Brookhart, J. 1972. Solpugids (Arachnida) in Colorado. *Southwestern Naturalist* 17: 31-41.
- Evans, H. E. 1966. *The Comparative Ethology and Evolution of the Sand Wasps*. Cambridge, MA: Harvard University Press. 526 pp.
- Evans, H. E., and K. M. O'Neill. 1988. *The Natural History and Behavior of North American Beewolves*. Ithaca, NY: Comstock Publishing Associates. 278 pp.
- Gregg, R. E. 1963. *The Ants of Colorado*. Boulder, CO: University of Colorado Press. 892 pp.
- Gwynne, D. T. 1978. Male territoriality in the bumblebee wolf, *Philanthus bicinctus* (Mickel) (Hymenoptera: Sphecidae): Observations on the

- behavior of individual males. *Zeitschrift fur Tierpsychologie* 47: 89-103.
- Gwynne, D. T. 1980. Female defense polygyny in the bumblebee wolf, *Philanthus bicinctus* (Hymenoptera: Sphecidae). *Behavioral Ecology and Sociobiology* 7: 213-225.
- Gwynne, D. T. 1981. Nesting biology of the bumblebee wolf *Philanthus bicinctus* Mickel (Hymenoptera: Sphecidae). *American Midland Naturalist* 105: 130-138.
- Gwynne, D. T., and H. E. Evans. 1975. Nesting behavior of *Larropsis chilopsidis* and *L. vegeta* (Hymenoptera: Sphecidae: Larrinae). *Psyche* 82: 275-282.
- Gwynne, D. T., and B. B. Hostetler. 1978. Mass emergence of *Prionus emarginatus* (Say) (Coleoptera: Cerambycidae). *The Coleopterists Bulletin* 32: 347-348.
- Gwynne, D. T., and K. M. O'Neill. 1980. Territoriality in digger wasps results in sex biased predation on males (Hymenoptera: Sphecidae: *Philanthus*). *Journal of Kansas Entomological Society* 53: 220-224.
- O'Neill, K. M. 1983a. The significance of body size in territorial interactions of male beewolves (Hymenoptera: Sphecidae, *Philanthus*). *Animal Behavior* 31: 404-411.
- O'Neill, K. M. 1983b. Territoriality, body size, and spacing in males of the beewolf *Philanthus basilaris* (Hymenoptera: Sphecidae). *Behaviour* 86:295-321.
- O'Neill, K. M., and H. E. Evans. 1981. Predation on conspecific males by females of the beewolf *Philanthus basilaris* Cresson (Hymenoptera: Sphecidae). *Journal of the Kansas Entomological Society* 54: 553-556.
- Rotger, B. 1944. A new species of *Cicindela* and two new records of Coleoptera. *Pan-Pacific Entomologist* 20: 76-77.
- Schenk, C. (ed.). (In press). Proceedings of the 1992 Research Symposium at Great Sand Dunes National Monument. Mosca, CO: Friends of the Dunes.
- Sluss, T. P. 1986a. Population density studies of the sand treader cricket at the Great Sand Dunes National Monument. Unpublished report to the Rocky Mountain Region of the National Park Service.
- Sluss, T. P. 1986b. Allozyme characterization of the giant sand treader (*Dailinibaebetes* [sic.] *giganteus*) at the Great Sand Dunes National Monument. Unpublished report to the Rocky Mountain Region of the National Park Service.
- Tinkham, E. R. 1962. Studies in nearctic desert sand dune Orthoptera, Part V: A new genus and two new species of giant sand treader camel crickets with keys and notes. *The Great Basin Naturalist* 22: 12-29.
- Triplehorn, C. A. 1964. A new species of *Eleodes* from Colorado (Coleoptera: Tenebrionidae). *The Ohio Journal of Science* 64: 60-62.
- United States Bureau of Reclamation. 1987. The San Luis Valley Project, Closed Basin Division: Design and planning of the project. U.S. Bureau of Reclamation, Denver, Colorado. 127.2/2:5A. 542.
- Weissmann, M. J., L. P. Clement, and B. C. Kondratieff. 1993. Insects and Other Arthropods of Great Sand Dunes National Monument. Tucson, AZ: Southwestern Parks and Monuments Association. 23 pp.

The Distribution of *Halictus ligatus* Say and *H. poeyi* Lep. (Hymenoptera: Halictidae) in North America

By

LAURENCE PACKER¹

ABSTRACT Based upon additional sampling, it is demonstrated that *Halictus poeyi* is found in the southeastern USA, along the coastal plains as far north as Richmond Virginia and along the Gulf Coast at least as far west as Galveston, Texas. *Halictus ligatus* is found to the north and west of these areas with the species being sympatric throughout the Piedmont.

Keywords: Sweat bees; Biogeography; Sympatry; Piedmont.

INTRODUCTION

Halictus ligatus Say has been considered one of the most widespread bees in the New World (Michener and Bennett, 1977; Knerer, 1980; Packer and Knerer, 1986). However, studies aimed at elucidating the level of genetic divergence among behaviorally differentiated populations led to the discovery that two genetically distinct species are involved: one found in the southeastern USA, the other to the north and west (Carman and Packer, 1997). The two species were reported as being sympatric at Charlotte, North Carolina; Rock Hill, South Carolina; and Chattanooga, Tennessee, where the seven fixed electrophoretic differences known in allopatry were retained in their entirety (Carman and Packer, 1997). Subsequent mitochondrial DNA sequence data indicate a 4% divergence between the two species (Danforth et al., in press), a result that supports species level differentiation for the two.

It should be noted that the zone where *H. ligatus* and *H. poeyi* meet and overlap has nothing to do with the zone across southern Florida, where within the range of *H. poeyi*, tropical—and temperate—adapted life cycles and behaviors may meet (Packer and Knerer, 1986; Carman and Packer, 1997).

Probably because of a combination of the great, allometrically based, morphological variability even within single colonies (Knerer, 1980), size variation between localities (Kirkton, 1968) and the rush of species descriptions in the Victorian era (Hull, 1988), what has since Sandhouse's (1941) revision become known as the single species *H. ligatus* had previously received no fewer than seven names. Carman and Packer (1997) considered it probable that the nominate form was the northern and western species and that *H. poeyi* Lep., described from Cuba, was the most likely name for the southeastern species.

The purpose of this paper is to update the distributional information for this species pair based upon large numbers of additional samples.

ACKNOWLEDGMENTS

I am grateful to Drs. Paula Levin Mitchell, James H. Cane, Bryan N. Danforth, Janet Joy, Mark Warren and Robert Minckley and Shannon-Lee Brome and Jennifer Lewin for help with accomodation and/or making collections. Mr. Asghar Porsa provided civilised and respectful laboratory assistance and Susan Cameron made sense of what is usually considered undecipherable scrawl. I am grateful for the comments of two anonymous referees and to Dr. George Byers for his editorial assistance. The author's research has been supported by research grants from the Natural Sciences and Engineering Research Council of Canada. This paper is dedicated to the memory of the late Byron Alexander whose gentle enthusiasm will be missed.

MATERIALS AND METHODS

Bees were collected from flowers, mainly at roadsides, on the edges of parking lots and gas stations, in September of 1995, 1996 and 1997 and April 1997. Both species are usually abundant, especially later in summer, and it was generally possible to collect a reasonable sample in a short time. More intense efforts were made in areas that seemed particularly important but nonetheless yielded smaller samples, especially in April 1997, when only overwintered foundresses were flying. Some areas yielded few or no specimens; in particular it proved difficult, in the short time period available for sampling, to find more than one suitable locality in the southern parts of the states of Texas, Louisiana and Mississippi. The 1995 and 1996 samples were obtained to discover the distributional limits of the two species in areas around that known to harbour both, and

¹ Department of Biology and Faculty of Environmental Studies, York University, 4700 Keele St., N. York, Ontario M3J 1P3, CANADA. E-mail: bugsrus@yorku.ca

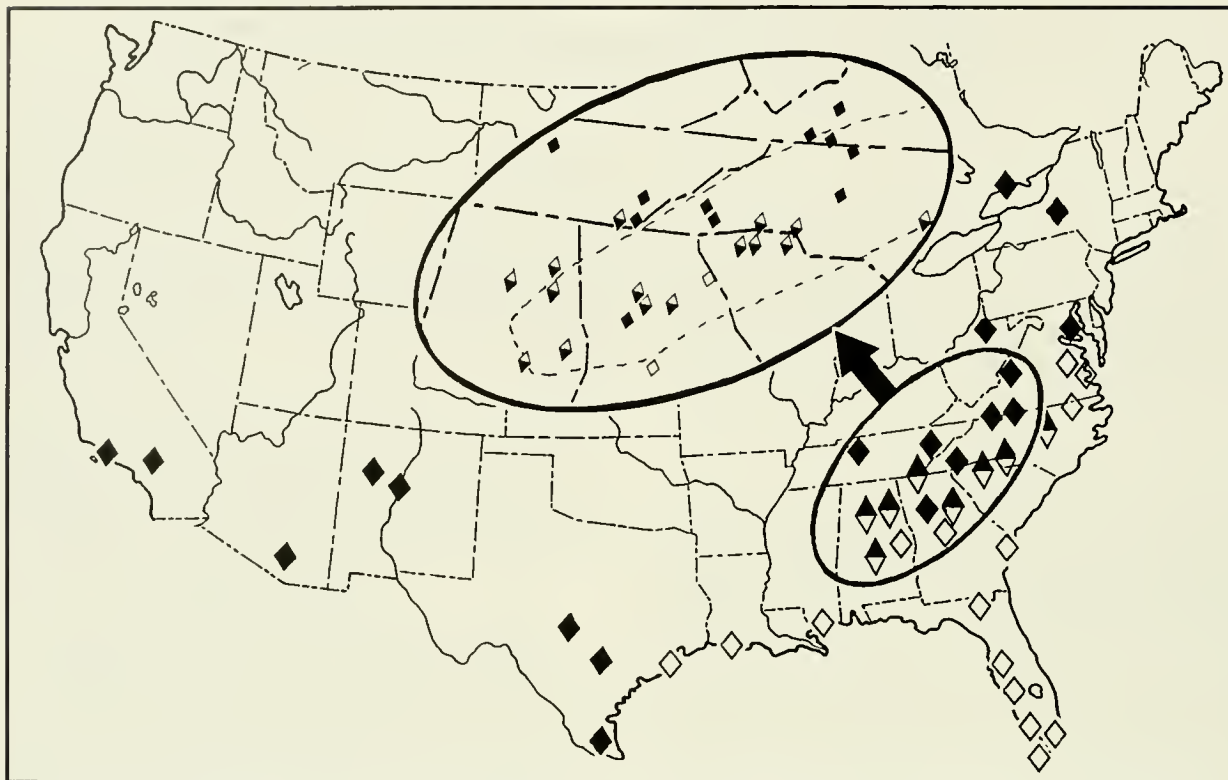

Fig. 1. Map showing known localities for *H. ligatus* (filled symbols), *H. poeyi* (open symbols) and both species sympatrically (half and half). All data are based upon electrophoresis of allozymes other than those from New York where mtDNA sequences were used. Because of the size of the symbols relative to the distances on the map, in some instances, one symbol refers to more than one locality listed. For sample sizes and more precise localities, see the text. The dashed line in the inset ellipse shows the approximate extent of the Piedmont region in the area.

the 1997 collections concentrated on establishing the western limits of *H. poeyi*.

In the absence of any known morphological differences, species identifications were based upon subsamples of the seven fixed electrophoretic differences noted elsewhere (Carman and Packer, 1997; Dunn et al., 1998) using identical protocols. All bees were typed for at least two of the loci: esterase—*Est*, fumarate hydratase—*Fum*, glucose phosphate isomerase—*Gpi*, glycerol-3-phosphate dehydrogenase—*G3pdh*, and malate dehydrogenase (NADP)—*Me*.

RESULTS AND DISCUSSION

In all, over 1000 females and 120 males have been surveyed for an average of between 3 and 4 diagnostic loci. All individuals were either purely *H. ligatus* or *H. poeyi* with the exception of four individuals. These were heterozygotes for one of several diagnostic loci as follows: two heterozygotes at *Gpi* were found at Moore, South Carolina, and one heterozygote at *Est* at both Spartanburg and Rock Hill, South Carolina. The first three of these individuals were of *H. poeyi* and the fourth of *H. ligatus*, as indi-

cated by homozygosity for two additional diagnostic loci. *Fum* is polymorphic in Californian populations but shows fixed differences between the species everywhere else including in sympatry. For example, at Rock Hill 78 *H. ligatus* and 218 *H. poeyi* females have been screened for *Fum*, and not a single heterozygote has been found. As yet, it remains uncertain whether the four heterozygotes for the other loci represent rare hybridization events or are remnants of past polymorphisms ancestral to the split between the species. It would also be interesting to discover the geographic limits of the *Fum* polymorphism. Data on population differentiation using these and other loci that are polymorphic within one or both of the species will be presented elsewhere pending additional sampling.

Localities where only *H. ligatus* was found are as follows.

CANADA, Ontario, Toronto 25 ♀♀; **USA**, CALIFORNIA, Fullerton, 30 ♀♀; Yucaipa 20 ♀♀; ARIZONA, Mount Lemmon 2 ♀♀, 8 ♂♂; NEW MEXICO, Mount Taylor, 2 ♂♂; Capilla Canyon, 14 ♀♀; TEXAS, Pleasantown 1 ♀; Kerrville 1 ♀; Brownsville 1 ♀; NEW YORK, Ithaca 5 ♀♀; WEST VIRGINIA, Martinsburg 14 ♀♀; VIRGINIA, Natural

Bridge 12 ♀♀; Fancy Gap 24 ♀♀; Nettleridge 16 ♀♀; DISTRICT OF COLUMBIA, Washington 8 ♀♀; NORTH CAROLINA, Statesville 16 ♀♀; Canton 25 ♀♀; Weldon 26 ♀♀, 11 ♂♂; Brevard 5 ♀♀; TENNESSEE, Etowah 5 ♀♀; Ocoee 15 ♀♀; Nashville 12 ♀♀; Knoxville 1 ♀; GEORGIA, Atlanta 7 ♀♀.

Localities where only *H. poeyi* was found are as follows.

USA, TEXAS, Galveston 16 ♀♀; VIRGINIA, Richmond 8 ♀♀; Williamsburg 12 ♀♀; MISSISSIPPI, Pass Christian 7 ♀♀; 5 ♂♂; LOUISIANA, West of Creole 13 ♀♀; 3 ♂♂, ALABAMA, Tuskegee 2 ♀♀; GEORGIA, Garden City 15 ♀♀; Macon 12 ♀♀; Elberton 15 ♀♀; Nokomis 15 ♀♀; FLORIDA, Lake City 18 ♀♀; Bee Line 6 ♀♀; Dade City 18 ♀♀; Bee Ridge 15 ♀♀; Fort Myers 23 ♀♀; Homestead 20 ♀♀; Plantation Key 10 ♀♀; Marathon 26 ♀♀.

Both species were found at the following locations.

USA, NORTH CAROLINA, Charlotte, *H. ligatus* 3 ♀♀, 1 ♂; *H. poeyi* 2 ♀♀; Raleigh, *H. ligatus* 7 ♀♀; *H. poeyi* 14 ♀♀, 3 ♂♂; TENNESSEE, Chattanooga, *H. ligatus* 8 ♀♀, *H. poeyi* 1 ♀, 1 ♂; SOUTH CAROLINA, Spartanburg, *H. ligatus* 1 ♀, *H. poeyi* 45 ♀♀, 4 ♂♂; Rock Hill, *H. ligatus* 80 ♀♀, 3 ♂♂; *H. poeyi* 234 ♀♀, 57 ♂♂; Moore, *H. ligatus* 1 ♀; *H. poeyi* 26 ♀♀; GEORGIA, Athens, *H. ligatus* 13 ♀♀, 2 ♂♂; *H. poeyi* 2 ♀♀; Lawrenceville, *H. ligatus* 6 ♀♀, 2 ♂♂; *H. poeyi* 2 ♂♂; Buford, *H. ligatus* 1 ♀; *H. poeyi* 1 ♀; Colbert, *H. ligatus* 12 ♀♀; *H. poeyi* 3 ♀♀; ALABAMA, Cheaha, *H. ligatus* 13 ♀♀; *H. poeyi* 3 ♀♀; Gadsden, *H. ligatus* 10 ♀♀; *H. poeyi* 11 ♀♀; Birmingham, *H. ligatus* 4 ♀♀; *H. poeyi* 6 ♀♀; Montgomery, *H. ligatus* 30 ♀♀, 1 ♂; *H. poeyi* 7 ♀♀, 1 ♂; Auburn, *H. ligatus* 1 ♀; *H. poeyi* 1 ♀.

These data presented here yield the distribution map shown in Figure 1. *Halictus poeyi* occurs throughout Florida and in the lower lying areas of the other southeastern states, extending northeastward along the coastal plain at least to Richmond, Virginia, and westward along the Gulf Coast at least as far as Galveston Island, Texas. *Halictus ligatus* occurs throughout North America south of the 50th parallel with the exception of the extreme Southeast and along the Gulf Coast where it is replaced by *H. poeyi*; it is also absent from much of the desert southwest, although it is found in moister areas at moderate to high elevations in this area. Its most southerly location presently known in the Southeast is Montgomery, Alabama, although further west three individuals have been found in widely separated locations in southern Texas. From this information it would seem possible that both species may be found in Mexico. The two species are sympatric in the Piedmont region from at least Raleigh, North Carolina, to Tuskegee, Alabama.

As with all distributional data, inferred limits are based on negative information: just because a species has not been found in a locality does not mean that it does not occur

there. Nonetheless, the data presented here are remarkably consistent. *Halictus poeyi* has not been found to the North of the Piedmont region and *H. ligatus* has not been found Southeast of this area. Furthermore, the two have been collected sympatrically throughout the Piedmont even where sample sizes are small, as at Tuskegee, Alabama, and Buford, Georgia, where only one individual of each species was collected.

Carman and Packer (1997) proposed three hypotheses for the distribution of these two species. The first, that *H. poeyi* became isolated in the Ocala highlands of Florida during a recent glacial minimum when sea levels were higher, would seem to be discounted by the large mtDNA divergence between samples, which is suggestive of an earlier divergence (Danforth et al., 1998). The second and third hypotheses are both predicated on divergence between *H. ligatus* and *H. poeyi* in Mexico, the Caribbean or further south. These two hypotheses differ in the route whereby *H. poeyi* invaded the southeastern USA—either along the Gulf Coast or via the Caribbean islands. The discovery of *H. poeyi* along the Gulf Coast at least as far west as Galveston adds some support to the former hypothesis. Cane (1997) has described other bee taxa which have attained the US Southeast by apparently similar routes. Clearly additional collections are needed from Mexico, Meso- and South America and in the Caribbean. It is also clear from Figure 1 that additional sampling is required to demarcate the northern limits of *H. poeyi* in Mississippi and Louisiana. Only when this information is available and appropriate phylogeographic analyses are performed (Avisé, 1991) will it be possible to place the current distributions of these two species within a meaningful evolutionary history context.

LITERATURE CITED

- Avisé, J. C. 1994. *Molecular Markers, Natural History and Evolution*. New York: Chapman and Hall. 511pp.
- Cane, J. H. 1997. A new monolectic coastal bee, *Hesperapis orara* Snelling and Stage (Hymenoptera: Melittidae), with a review of desert and neotropical disjunctives in the southeastern U.S. *J. Kans. Entomol. Soc.* 69: 238–247.
- Carman, G. M., and L. Packer. 1997. A cryptic species allied to *Halictus ligatus* Say (Hymenoptera: Halictidae) detected by allozyme electrophoresis. *J. Kans. Entomol. Soc.* 69: 168–176.
- Danforth, B. N., P. Levin Mitchell and L. Packer. 1998. Mitochondrial DNA differentiation between two cryptic *Halictus* (Hymenoptera: Halictidae) species. *Ann. Entomol. Soc. Amer.* 91:387–391.
- Dunn, M., P. Levin Mitchell and L. Packer. 1998. A comparison of the phenology and social biology of two sibling species of *Halictus* in an area sympatry. *Can. J. Zool.* in press.
- Hull, D. L. 1988. *Science as a process*. University of Chicago Press, Chicago.
- Kirkton, R. M. 1968. Biosystematic analysis of variation of variation of *Halictus* (*Halictus*) *ligatus* Say. Unpublished PhD thesis, Purdue University.

- Knerer, G. 1980. Biologie und Sozialverhalten von Bienenarten der Gattung *Halictus* Latreille (Hymenoptera, Halictidae) Zoologische Jahrbücher, Abteilung für Systematic Ökologie und Geographie der Tiere. 107: 511–536.
- Michener, C.D. and F.D. Bennett. 1977. Geographical variation in nesting biology and social organization of *Halictus ligatus*. Univ. Kansas Sci. Bull. 51: 233–260.
- Packer, L., and G. Knerer. 1986. The biology of a subtropical population of *Halictus ligatus* (Hymenoptera, Halictidae). I. Phenology and social organization. Behav. Ecol. Sociobiol. 18: 363–375.
- Sandhouse, G. A. 1941. The American bees of the subgenus *Halictus*. Entomologica Americana 21: 23–39.

Origins of Symbiosis: Phylogenetic Patterns of Social Insect Inquilinism in Cryptophagidae (Coleoptera: Cucujoidea)

By

RICHARD A. B. LESCHEN¹

ABSTRACT Natural history and phylogenetic information for the family Cryptophagidae are reviewed and used to examine the evolution of inquilinism with social insects. Most members of the family are free-living and mycophagous. Other members, such as the phoretic genus *Antherophagus*, are obligate symbionts and occur as inquilines in the nests of social insects. Shifts from free-living to inquilinism occurred at least twice, with the greatest diversity of symbiotic species being found in the tribe Cryptophagini. Understanding the true nature of shifts to symbiosis is complicated by different interpretations of the character states for inquilinism. A strictly ecological interpretation of inquilinism is useful in determining the origin of symbiosis, while taxon-based interpretations are useful in addressing frequency of host shifts and host specificity. Evidence suggests that inquilinism in the *Cryptophagus* group has evolved twice: a phoretic form of symbiosis in the genus *Antherophagus*, an inquiline of *Bombus* bees, and a nonphoretic form of symbiosis in the remaining taxa associated mainly with ants. Shifts to inquilinism in Cryptophagidae appear to be mediated by habitat: Decaying microhabitats present in nests of certain social insects are similar to those habitats used by free-living ancestral cryptophagids. Some shifts to inquilinism were accompanied by changes in diet from mycophagy to saprophagy and changes in color pattern. There is also a relative reduction in the total number of glandular ducts associated with symbiosis. Rate of morphological change based on branch length increased subsequent to the origin of symbiosis in the limuloid genus *Catopochrotus*. Unlike many other groups of beetle symbionts, cryptophagid inquiline lineages do not have marked increases in speciation rates, despite the records of some inquiline genera in 30 million year old amber. Cryptophagid inquilines are more or less restricted to the Holarctic, although *Antherophagus* species have dispersed with their *Bombus* hosts to tropical regions.

Key Words: Behavior; Social insects; Symbiosis; Homology; Diet; Speciation; Phylogeny.

INTRODUCTION

Of the approximately 120 terrestrial families of beetles, about half have some members that live in symbiotic associations with social insects (Kistner, 1979). Some of these monophyletic groups of beetles occurring as inquilines with ants, termites, wasps, or bees, may contain hundreds of species (e.g., paussine carabids, aleocharine staphylinids, hetaerine histerids). Often these beetles have complex behaviors and body forms that differ drastically from their ancestral groundplans. Systematic studies show that inquilines co-speciate (or host-track), shift, or maintain fidelity with their social insect hosts (e.g., Seevers, 1957, 1965; Kistner, 1979). To date, the origin of inquilinism has not captured as much scientific attention as has the evolution of symbiosis beyond initial colonization events. This may be due to the focus on the extraordinary morphologies and behaviors that accrue in evolutionary time within inquiline lineages as they evolve with their respective hosts.

Despite the exciting discoveries made regarding the behavior and morphology of beetle inquilines, little is

understood about how shifts from free-living habits to symbiosis occur. Reconstructed phylogenies can be used to demonstrate how these shifts from free-living to derived symbiotic interactions are mediated by behavior or ecology. Therefore, it is necessary to have a phylogeny of a monophyletic taxon composed of a mixture of free-living and inquiline species. An appropriate group for studying the origin of social insect inquilinism is the family Cryptophagidae, which contains such a mixture of symbiotic and free-living species (Leschen, 1996). In this paper I will review the literature on cryptophagid inquilines, examine their host relationships, and determine the phylogenetic patterns of host use and evolution of social insect inquilinism.

Homology as an evolutionary novelty defines natural lineages; how it is defined affects interpretation of biological phenomena and phylogenetic analysis (Pogue and Mickevich, 1990; Mickevich and Weller, 1990; de Pinna, 1991; Wilkinson, 1995). Inquilinism is a complex character composed of several character states that can be defined to reflect ecological association (Wenzel, 1992; Miller and

¹ Landcare Research, Private Bag 92 170, 120 Mt Albert Road, Auckland, NEW ZEALAND. E-mail: leschen@landcare.cri.nz

Wenzel, 1995) or taxonomic rank of the social insect host. The reconciliation of the homology among these character states may be difficult. For example, use of simplified two-state definitions that pool several "ecologically independent observations" for inquilinism (free-living and symbiosis) may indicate the number of origins in a phylogeny but may not be useful in recognizing details about the evolution of specific host-use patterns (i.e., those shifts among ant, bee and termite associations). Therefore, reconstructing the number of times free-living ancestors colonized their social insect hosts is directly affected by character state definitions of inquilinism. In this paper, differences in multistate character coding that affect theories about the origin and character evolution of inquilinism are also investigated.

The shift from free-living to inquilinism can be studied by examining the origin of social insect symbiosis revealed by character mapping host associations and other features onto reconstructed phylogenies (Brooks and McLennan, 1991; Wenzel and Carpenter, 1994). Traits that promote inquilinism in ancestors and their descendants may provide clues to the origin of symbiosis. For example, Wilson (1971) and Kistner (1979) assert that ancestors of symbionts will share similar habits with those present in derived lineages of inquilines. This is probably the situation for many staphylinid symbionts that retain ancestral behaviors (Akre and Rettenmeyer, 1966). A test of this "ancestral similarity hypothesis" would be to demonstrate that behavioral or ecological traits are maintained in the ancestor-descendant lines of cryptophagids. An ecological role that is similar in an ancestor and its descendants is evidence for a habitat-mediated shift to symbiosis.

Because of the asymmetry in the number of symbiotic species occurring in certain lineages, Wilson (1979) suggested that certain taxa are more prone to evolve inquilinism than others. In a phylogenetic framework, Wilson's assertion is best formulated in two ways that reflect relative rates of evolution. 1) Symbiosis may have repeatedly evolved in a single monophyletic group, indicating a relatively high rate of homoplasy localized in a global phylogeny. This pattern reflects an increased rate of shifting from free-living to symbiosis. 2) The numbers of species contained in two sister taxa, where one is free-living and the other is symbiotic, are asymmetrical indicating different rates of speciation. Asymmetrical rates of speciation, subsequent to the origin of a trait are often thought of as adaptive zones (Sanderson and Donoghue, 1994). If certain groups are "predestined" to evolve symbiosis, then inquiline taxa may be localized in certain areas of the cryptophagid phylogeny or have increased speciation rates.

There are a variety of morphological, chemical and behavioral traits that evolve in the context of symbiosis

(Wasmann, 1894; Wheeler, 1910; Akre and Rettenmeyer, 1966; Seevers, 1965; Wilson, 1971; Kistner, 1979; Dettner and Leipert, 1994). Diets of inquilines may change concomitantly with, or subsequent to, shifts from free-living to symbiosis (Wilson, 1979). This ecological change in diet may indicate a strong behavioral tie to the social insect host (i.e., trophallaxis between symbiont and host) or novel use of a food resource present only in the newly colonized habitat of social insect nests. Trophic specialization of the symbiont may be demonstrated by repeated changes in diet within cryptophagid inquilines. Trophic specialization and morphological characters that may be associated with inquilinism (e.g., body color and hind wing loss or reduction) are examined in this paper.

Use of chemicals for appeasement and protection in nests of social insects may be common in inquilines (Dettner and Leipert, 1994; Hölldobler and Wilson, 1990). In many symbiotic beetle groups, complex sets of glandular ducts, trichomes, and invaginations facilitate chemical production and release (Kistner, 1979). With regard to phylogenetic changes, glandular structures in staphylinid inquilines in the subfamily Aleocharinae may either be significantly reduced or become more complex (Steidle and Dettner, 1993). Many members of Cryptophagidae have simple and bifurcate cuticular gland ducts located in the body (Leschen, 1996). Interestingly, inquiline glandular ducts do not differ in form from those present in free-living taxa; however, the total number of ducts does differ. Number of glandular ducts may change concurrently with symbiosis in cryptophagids, as has morphology and chemistry in some Staphylinidae (Steidle and Dettner, 1993).

ACKNOWLEDGMENTS

I thank Anita Davelos, Heather Rowe, Tao Sang, and John Wilterding for reviews of the manuscript. John Wenzel suggested an alternative coding strategy for recognizing phoretic and nonphoretic symbiosis and provided helpful comments on the manuscript. This research was supported in part by NSF grant DEB-9222863 and a University of Kansas Graduate Student Fellowship. For supplying unpublished host records, host determinations, and clarifying current taxonomy of hosts I thank Robert Brooks, John L. Carr, Colin Johnson, Chris Marshall, Charles D. Michener and Fernando Silveira. Finally I thank Byron Alexander for sharing with me his knowledge, wisdom, and friendship, all of which I truly miss.

NATURAL HISTORY OF CRYPTOPHAGIDAE

Byron Alexander had a fascination for natural history and evolutionary principles. He recognized that evolutionary hypotheses about the origins of behavior are incomplete without natural history information (whether anecdotal or empirical). Without natural history data there is

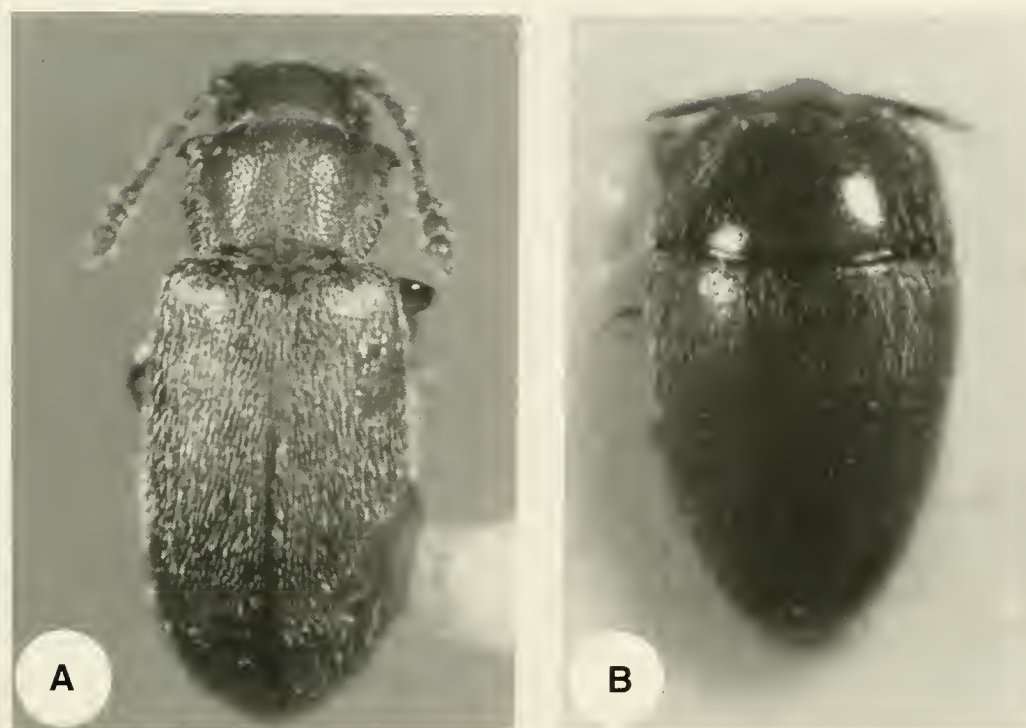

Fig. 1. Dorsal views of Cryptophagidae. A—*Cryptophagus acutangulus* Gyllenhal (Length = 2.12 mm). B—*Catopochrotus crematogastris* Reitter (Length = 2.44 mm).

no basis for biological science, and were it not for the naturalists Darwin and Wallace the history of biology may have been very different. A complete understanding of the evolution of symbiosis in Cryptophagidae relies on empirical and anecdotal information about symbiotic species. Typically, anecdotal observations are initially cast as first principles that are followed by empirical research (Hempel, 1966). Therefore, anecdotal data must be regarded as scientific and as valid contributions to the process of scientific inquiry. Moreover, much of comparative behavioral research hinges on anecdotal observations because of the inherent limitations due to organismal rarity (and that of behavioral activities), time, and money.

Natural history information for cryptophagid inquilines is provided in Table 1. Based on primary literature, most observations were made from the 1800's to 1920 (80%) with a significant decline in later years, perhaps due to a lack of appreciation for natural history information and an increased emphasis on experimental research programs. The older literature is subject to taxonomic errors and misidentifications, and I have tried to correct for these in Table 1 by verifying current usage of names with specialists or consulting catalogues.

Members of Cryptophagidae are typically small (0.8–5.2 mm) and are distributed around the world, but are most diverse in cool temperate environments (Crowson, 1980;

Leschen, 1996). The family contains over 400 described species in 53 genera contained in two subfamilies, Cryptophaginae Kirby (with three tribes [Cryptophagini Kirby, Caenoscelini Casey, and Cryptosomatulini Crowson] and 30 genera) and Atomariinae LeConte (with three tribes [Atomariini LeConte, Cryptafricini Leschen, and Hypocoprini Reitter] and 18 genera). Two informal groupings in Cryptophagini are recognized by Leschen (1996), each containing 10 genera: the *Cryptophagus* group and the *Henoticus* group. Based on the literature review, inquilinism occurs in the *Cryptophagus* group (Leschen, 1996) and in the genus *Hypocoprus* in Atomariinae (Hypocoprinae) with a few records for other genera (Table 1). Only those taxa consistently associated with, or known only from, social insect nests are treated in this paper. Information below summarizes morphology, behavior, and hosts of symbionts of the taxa examined in this study.

CRYPTOPHAGUS GROUP

The *Cryptophagus* group is characterized by the absence of cephalic glandular ducts, presence of star-like microglandular ducts on the prosternum, and presence of functional spiracles on abdominal segments 1–7. A character that is present in this group is an "angularity" found on the anterior lateral margin of the pronotum (Fig. 1a). This structure typically consists of a flattened platform with

Table 1. Host records and citations for species of Cryptophagidae occurring with social insects.

Taxon	Interaction		
	N=in nest/P=phoresy	Host & Reference	
CRYPTOPHAGINI			
<i>Antherophagus brasiliensis</i> Grouvelle			
	P	<i>Bombus brasiliensis</i> Lepeletier (F.Silveira, pers. obs.)	
<i>A. canescens</i> Grouvelle	N	<i>Bombus lapidarius</i> (Linnaeus) (Rüschkamp 1926 in Horion 1960; Koch 1989)	
<i>A. ludekingi</i> Grouvelle	N*	<i>Bombus eximius</i> Smith (Grouvelle 1911a)	
	N	<i>Bombus rufipes</i> Lepeletier (Kato et al. 1992)	
	N	<i>Bombus senex</i> Vollenhoven (Meer Mohr & Leiftink 1947)	
<i>A. nigricornis</i> (Fabricius)	N	<i>Bombus agrorum</i> (Schrank) (Cumber 1949)	
	N	<i>Bombus hortorum</i> (Linnaeus)(Cumber 1949)	
	N	<i>Bombus lapidarius</i> (Linnaeus) (Cumber 1949)	
	P	<i>Bombus montanus</i> Lepeletier (Perris 1869-70)	
	N	<i>Bombus muscorum</i> (Linnaeus) (Donisthorpe 1904)	
	P	<i>Bombus opulentus</i> Smith (Trautman 1915)	
	P	<i>Bombus pratorum</i> (Linnaeus)(Frisch 1952; Cumber 1949)	
	N	<i>Bombus ruderarius</i> Müller (Cumber 1949)	
	N	<i>Bombus subterraneus</i> (Linnaeus) (=latreillellus) (Tuck 1896)	
	P	<i>Bombus sylvarum</i> (Linnaeus) (Bold 1856; Perris 1876)	
	N	<i>Bombus terrestris</i> (Linnaeus) (=lucorum) (Tuck 1897; Buckle 1900; Cumber 1949)	
	N*	<i>Bombus</i> sp. (Eichoff 1866; Tuck 1896)	
	<i>A. ochraceus</i> Melsheimer	N	<i>Bombus affinis</i> Cresson (Husband & Brown 1976)
		N	<i>Bombus ephippiatus</i> Say (Grouvelle 1911b)
N*		<i>Bombus fervidus</i> Fabricius (Frison 1921; Husband & Brown 1976)	
N		<i>Bombus nevadensis</i> Cresson (=auricomus) (Frison 1921)	
N		<i>Bombus pennsylvanicus</i> DeGeer (=americanorum) (Husband & Brown 1976)	
N,P		<i>Bombus vagans</i> Smith (Wheeler 1919; Husband & Brown 1976)	
N		<i>Bombus</i> sp. (Packard 1864; Smith 1909)	
<i>A. pallens</i> (Fabricius)		N*	<i>Bombus agrorum</i> (Schrank) (Tuck 1896; Grandi 1936)

Table 1 (Continued)

Taxon	Interaction	
	N=in nest/P=phoresy	Host & Reference
<i>A. pallens</i> (continued)	N	<i>Bombus hortorum</i> (Linnaeus) (Dollman 1912; Horion 1960; Koch 1989)
	N	<i>Bombus lapidarius</i> (Linnaeus) (Tuck 1896; Horion 1960; Koch 1989)
	N*	<i>Bombus muscorum</i> (Linnaeus)(Cottam 1909; Donisthorpe 1920; Horion 1960; Koch 1989)
	N	<i>Bombus pratorum</i> (Linnaeus)(Gorham 1869)
	N*	<i>Bombus ruderarius</i> Müller (=derhamellus)(Scott 1920)
	N	<i>Bombus sylvarum</i> (Linnaeus)(Tuck 1896)
	P	<i>Bombus</i> sp. (Bugnion 1869-70)
	N	<i>Bombus</i> sp.(Eichoff 1866)
<i>Antherophagus</i> sp. (Holarctic)	N*	<i>Bombus impatiens</i> Smith (Plath 1922)
	N	<i>Bombus ruderarius</i> Müller (=derhamellus) (Bold 1856)
	P	<i>Bombus</i> sp. (Seidlitz 1869-70)
	N*	<i>Bombus</i> sp. (Donisthorpe 1906)
<i>Antherophagus</i> sp. (Columbia)	N	<i>Bombus atratus</i> Franklin (Roubik & Wheeler 1982)
<i>Antherophagus</i> sp. (Costa Rica)	N*	<i>Bombus ephippiatus</i> Say (Chavarria 1994b)
	P	<i>Bombus pullatus</i> Franklin (Chavarria 1994a)
<i>Antherophagus</i> sp. (Venezuela)	P	<i>Bombus</i> (<i>Pyrobombus</i>) <i>robustus</i> Smith (R. Brooks & C. Marshall, pers. obs.).
<i>Catopochrotus crematogastris</i> Reitter		
	N	<i>Crematogaster subdentata</i> Mayr (Reitter 1889)
<i>Cryptophagus badius</i> Sturm	N	<i>Vespa crabro</i> Linnaeus (Tuck 1897)
<i>C. cellaris</i> Scopoli	N	<i>Anthophora</i> sp. (Falcoz 1929)
	N	<i>Lasius fuliginosus</i> (Latreille) (Palm 1953 in Horion 1960)
<i>C. confusus</i> Bruce	N	<i>Lasius brunneus</i> Latreille (Koch 1989)
<i>C. croceus</i> Zimmerman	N	<i>Bombus pennsylvanicus</i> (DeGeer) (=americanorum) (Frison 1926)
<i>C. digueti</i> Grouvelle	N	<i>Bombus ephippiatus</i> Say (Grouvelle 1911b)
<i>C. distinguendus</i> Sturm (=umbratus) Erichson		
	N	<i>Bombus agrorum</i> (Buckle 1900)
	N	<i>Bombus hortorum</i> (Dollman 1912)
	N	<i>Bombus terrestris</i> (Buckle 1900)
	N	<i>Bombus</i> sp. (Tuck 1896)
	N	<i>Vespula vulgaris</i> (Tuck 1897)
<i>C. fumatus</i> Marsham	N	<i>Formica exsecta</i> Nylander (Falcoz 1929; Kieseritzky & Reichardt 1936)
	N	<i>Osmia</i> sp. (Falcoz 1929)

Table 1 (Continued)

Taxon	Interaction		
	N=in nest/P=phoresy	Host & Reference	
<i>C. fuscicornis</i> Sturm	N	<i>Lasius brunneus</i> (Koch 1989)	
	N	<i>Lasius fuliginosus</i> (Koch 1989)	
	N	<i>Vespa</i> sp. (Koch 1989)	
<i>C. intermedius</i> Bruce	N	<i>Lasius brunneus</i> (Horion 1960)	
<i>C. labialis</i> Erichson	N	<i>Lasius brunneus</i> (Koch 1989)	
	N	<i>Myrmica ruginodis</i> Nylander (Koch 1989)	
<i>C. lycoperdi</i> (Scopoli)	N	<i>Bombus lardarius</i> (Horion 1960)	
	N	Tree-living wasps (Coombs & Woodroffe 1955)	
<i>C. pallidus</i> Sturm	N	<i>Bombus</i> sp. (Koch 1989)	
<i>C. pilosus</i> Gyllenhal (= <i>punctipennis</i> Bris. de Barn.)	N	Bees (Horion 1960)	
	N	<i>Bombus agrorum</i> (Tuck 1896)	
	N	<i>Bombus hortorum</i> (Tuck 1896)	
	N	<i>Bombus</i> sp. (Joy 1932)	
	N	<i>Vespula vulgaris</i> (Tuck 1896)	
<i>C. populi</i> Paykull	N	<i>Andrena</i> sp. (Falcoz 1929)	
	N	<i>Colletes daviesanus</i> Smith (Falcoz 1929)	
	N	<i>Colletes</i> sp. (Horion 1960)	
	N	<i>Dasygaster lirtipes</i> (Fabricius) (Falcoz 1929)	
<i>C. pubescens</i> Sturm (= <i>micaceus</i> Rey)	N	Bees (Horion 1960)	
	N	<i>Bombus hortorum</i> (Tuck 1896)	
	N	<i>Bombus sylvarum</i> (Tuck 1896)	
	N	<i>Bombus terrestris</i> (Tuck 1896)	
	N	<i>Bombus</i> sp. (Eichhoff 1866; Falcoz 1929; Koch 1989)	
	N	Ground-nesting wasps (Coombs & Woodroffe 1955; Horion 1960)	
	N	<i>Vespa crabro</i> (Falcoz 1929; Coombs & Woodroffe 1955; Koch 1989)	
	N	<i>Vespula germanica</i> (Fabricius) (Tuck 1896; Falcoz 1929)	
	N	<i>Vespula vulgaris</i> (Eichhoff 1866; Tuck 1896)	
	N	<i>Vespa</i> sp. (Falcoz 1929; Koch 1989)	
	N	Wasp nests (Joy 1932)	
	<i>C. quercinus</i> Kraatz	N	<i>Lasius fuliginosus</i> (Horion 1960)
	<i>C. saginatus</i> Sturm	N	** <i>Bombus venustus</i> (Tuck 1896)
<i>C. scanicus</i> (Linnaeus)	N	** <i>Bombus venustus</i> (Tuck 1896)	
	N	<i>Vespa crabro</i> (Tuck 1897)	
	N	<i>Vespula vulgaris</i> (Tuck 1897)	
	N	<i>Vespula germanica</i> (Tuck 1896)	
<i>C. schmidti</i> Sturm	N	<i>Vespa</i> sp. (Falcoz 1929)	
<i>C. scutellatus</i> Newman	N	Bees (Horion 1960)	
	N	<i>Bombus</i> sp. (Koch 1989)	
	N	<i>Formica</i> sp. (Koch 1989)	
<i>C. setulosus</i> Sturm	N	Bees (Coombs & Woodroffe 1955; Horion 1960)	
	N	<i>Bombus agrorum</i> (Schränk) (Tuck 1896; Buckle 1900; Cumber 1949)	

Table 1 (Continued)

Taxon	Interaction	
	N=in nest/P=phoresy	Host & Reference
<i>C. setulosus</i> (continued)	N	<i>Bombus lapidarius</i> (Linnaeus) (Horion 1960)
	N	<i>Bombus muscorum</i> (Linnaeus) (Donisthrope 1904)
	N	<i>Bombus pratorum</i> (Linnaeus) (Cumber 1949)
	N	<i>Bombus ruderarius</i> Müller (Cumber 1949)
	N	<i>Bombus terrestris</i> (Linnaeus) (Buckle 1900; Cumber 1949)
	N	<i>Bombus</i> sp. (Eichhoff 1866; Falcoz 1929; Joy 1932; Koch 1989)
	N	<i>Vespa</i> sp. (Falcoz 1929; Koch 1989)
	N	Wasps (Horion 1960)
<i>C. valens</i> Casey	N	<i>Bombus affinis</i> Cresson (Husband & Brown 1976)
<i>Cryptophagus</i> sp. (North America)		
	N	<i>Bombus pennsylvanicus</i> (DeGeer) (= <i>americanorum</i>) (Husband & Brown 1976)
<i>Henoticus brucei</i> Leschen & Johnson (= <i>brevis</i> Grouvelle)		
	N	<i>Bombus ephippiatus</i> Say (Grouvelle 1911b)
<i>Myrmedophila americana</i> (LeConte)		
	N	<i>Formica sanguinea</i> Latreille (Scwarz & Ulke 1891)
	N	<i>Formica</i> sp. (Bousquet 1989)
<i>Spaniophaeus lapidarius</i> Fairmaire		
	N	<i>Messor</i> (= <i>Aphaenogaster</i>) <i>barbarus</i> (Linnaeus) (Falcoz 1929)
<i>S. laticollis</i> (Miller)	N	<i>Anacanthotermes ahngerianus</i> (Jacobson) (Kieseritzky & Reichardt 1936)
<i>Spavivus glaber</i> Motschulsky	N	<i>Formica congerens</i> Nylander (Reitter 1875)
	N	<i>Formica glaber</i> † (Kieseritzky & Reichardt 1936)
	N	<i>Formica polycetena</i> Foerster (Koch 1989)
	N*	<i>Formica rufa</i> (Chaudoir 1845; Reitter 1875; Falcoz 1929; Eichelbaum 1927; Kieseritzky & Reichardt 1936; Horion 1960; Bernard 1968)
	N	<i>Formica sanguinea</i> (Falcoz 1929)
	N	<i>Messor</i> (= <i>Formica</i>) <i>capitatus</i> (Latreille) (Motschulsky 1844)
CAENOSCELINI		
<i>Caenoscelis ferruginea</i> (Sahlberg)		
	N	<i>Lasius fuliginosus</i> (Joy 1932)
ATOMARIINI		
<i>Atomaria guttula</i> Mannerheim	N	<i>Formica rufa</i> Linnaeus (Motschulsky 1844)
<i>A. fuscipes</i> (Gyllenhal) (= <i>C. concolor</i> Märkel)		
	N	<i>Formica rufa</i> (Motschulsky 1844)
<i>A. peltata</i> (Marshall)	N	<i>Bombus</i> sp. (Tuck 1896)

Table 1 (Continued)

Taxon	Interaction	
	N=in nest/P=phoresy	Host & Reference
<i>A. punctithorax</i> Reitter	N	<i>Vespa crabro</i> Linnaeus (Johnson 1993)
<i>A. pusilla</i>	N	<i>Formica rufa</i> (Motschulsky 1844)
<i>A. rubricollis</i> Bris. de Barneville	N	<i>Lasius flavus</i> Fabricius (Johnson 1993)
<i>A. testacea</i> Stephens (= <i>ruficornis</i> Marsham)	N	<i>Vespula vulgaris</i> (Tuck 1896)
<i>Ephistemus</i> sp. (Central America)	N	Formicidae (C. Johnson, pers. com.)
HYPOCOPRINI		
<i>Hypocoprus formicetorum</i> Motschulsky [†]	N	<i>Formica rufa</i> (Motschulsky 1844)
<i>H. latridioides</i> Motschulsky	N	<i>Formica exsecta</i> (Kieseritzky & Reichardt 1936)
	N	<i>Formica fuliginosa</i> (Motschulsky 1844)
	N	<i>Formica fusca</i> Linnaeus (Motschulsky 1844)
	N	<i>Formica rufa</i> (Chaudoir 1845; Kieseritzky & Reichardt 1936)
<i>H. tenuis</i> Casey	N	<i>Formica</i> sp. (Crowson 1955; Colin Johnson pers. com.)
	N	<i>Formica</i> sp. (J.L. Carr, pers. com.)

* Larval and adult record.

** Records for *B. venustus* may be *B. humilis* Illiger or *B. subterraneus* (Linnaeus).

† Probably a junior synonym of *H. latridioides* Motschulsky.

‡ A junior synonym of *Formica gagates* Dallatorre or *F. picea* Nylander (Bolton 1995).

a well-defined peripheral rim and serves as an evaporative surface for secretions released from cuticular glandular ducts. Although the angularity is a landmark structure for the recognition of the *Cryptophagus* group by beetle taxonomists, it varies considerably among the taxa of this group (it is reduced in *Antherophagus*, *Catopochrotus* [Fig. 1b], some *Cryptophagus*, and *Spaniophanus*), and is present in two genera outside the *Cryptophagus* group (Coombs and Woodroffe, 1955; Leschen, 1996). Members of the *Cryptophagus* group are 1.9–5.2 mm in length, with some species of *Antherophagus* attaining the largest size among cryptophagid species.

***Antherophagus* DeJean.**—*Antherophagus* contains 13 species distributed mainly in the Holarctic with some species in both the Old and New World tropics. These are well known inquiline of *Bombus* bees and have been collected in the nests as larvae and adults. Adults are typically golden brown or tan in color with a vestiture of short sparse setae. These beetles are sexually dimorphic; females are unmodified while males have a clypeal notch and com-

compact antennomeres. There are records of phoresy for tropical and temperate species, adults of which have been found attached to mouthparts, legs or antennae by their mandibles. Some species of tropical *Antherophagus* have a reduced number of eye facets and are flightless (hind wings are reduced or vestigial), such as *A. hudekingi* Grouvelle (Java) and *A. ruficornis* Grouvelle (South America). Although the life history of *Antherophagus* species has not been fully documented, it is known that adults of holarctic species (e.g., Wheeler, 1919, and Frison, 1921) wait for foraging *Bombus* at flowers, attach to the body and are carried to the nest where, presumably, mating and oviposition ensues.

***Catopochrotus* Reitter.**—(Fig. 1B). *Catopochrotus* contains a single species distributed in the Caucasus region of southeastern Europe and was originally described in a separate monotypic family (Reitter, 1889). As the name *C. crematogastris* Reitter implies, specimens have been collected from nests of ants in the genus *Crematogaster*. Adults are brown with well developed, suberect setae. The body is limuloid with the head retracted into the prothorax, and the legs are somewhat flattened and concealed beneath the body. The antenna is in the form of an incrassate club with compact antennomeres. The hind wings are well developed. Nothing has been recorded on the life history of this species and the larva is unknown. There are only a few published records for this species in ant nests; most of the specimens examined by Leschen (1996) were pinned with their host ant species.

***Cryptophagus* Herbst.**—(Fig. 1A). *Cryptophagus* is one of the most diverse cryptophagid genera and contains more than 200 described species distributed throughout the world. Most species have been described from the Holarctic, although there are some species that are widely distributed stored-grain pests, and a few species occur in northern tropical regions. The hind wings are well developed in most species but there are many continental and island species in which they are reduced or completely absent. Some species of *Cryptophagus* have been collected from social insect nests; however, because of their occurrence in other habitats as adults and larvae (Hinton, 1945; Horion, 1960; Koch, 1989), these records may be incidental and indicative of species that are habitat generalists. Therefore, in this paper, contrary to Leschen (1996), members of *Cryptophagus* are considered free-living.

***Myrmedophila* Bousquet.**—*Myrmedophila* contains a single species, *M. americanus* (LeConte), distributed in western North America. Adults are red with sparse pubescence. The head is somewhat retracted into the prothorax, and the tarsi and antennomeres are slightly compact. The hind wings are fully developed. This species most closely resembles species in the genera *Cryptophagus* and

Spavius and has been regarded as a member of *Cryptophagus* by Ljubarsky (1992). Nothing has been recorded about its life history, although specimens have been collected from the thatched mounds of *Formica* ants. The larva is unknown.

***Spaniophaeus* Reitter.**—*Spaniophaeus* contains three species distributed in southern Europe (Otero and Diaz Pazos, 1995). *Spaniophaeus* have been collected as adults from termite and ant nests. Adults are brown with well developed suberect setae. The head is retracted into the prothorax and the hind wings are well developed or reduced. Nothing has been recorded on the life history of *Spaniophaeus*, although specimens have been collected from insect nests and under stones (Ljubarsky, 1992), suggesting that members of this genus may be facultative inquilines. The larva is unknown.

***Spavius* Motschulsky.**—*Spavius* contains a single palaeartic species. Adults are red with sparse pubescence. This species most closely resembles *M. americanus* (Bousquet, 1989). The head is retracted into the prothorax, and the tarsi and antennomeres are slightly compact. The hind wings are well developed. Adult and larval specimens are commonly collected from the thatched mounds of *Formica* ants and the larva is described (Eichelbaum, 1927).

HYPOCOPRINI

The tribe Hypocoprini (Atomariinae), containing three genera, is perhaps the most enigmatic group of cryptophagids. They are minute (0.8–2.2 mm), and the occurrence of two genera (*Alfieriella* Wittmer and *Amydropa* Reitter) in drier habitats and the presence of several unique morphological features not present in other cryptophagids (e.g., lack of a pronotal bead, prosternum long in front of procoxae) led Leschen (1996) to doubt their inclusion in the family. One genus, below, is a putative inquiline.

***Hypocoprus* Motschulsky.**—Members of *Hypocoprus* occur in the Holarctic and have been collected in ant nests (*Formica*) and in leaf litter (Crowson, 1955; Leschen, 1996), and it is not clear if the species (or all populations) are true inquilines. For example, many specimens of the North American species *H. tenuis* Casey have been collected in *Formica* nests, while the Old World *H. lathridioides* Motschulsky may be free-living or found in ant nests. Hind wings in these species are well developed. The larva is unknown.

PHYLOGENETIC METHODS

Evolutionary studies based on phylogenetic information are only as good as the phylogenies they are based upon. That is, if any phylogenetic hypothesis is spurious

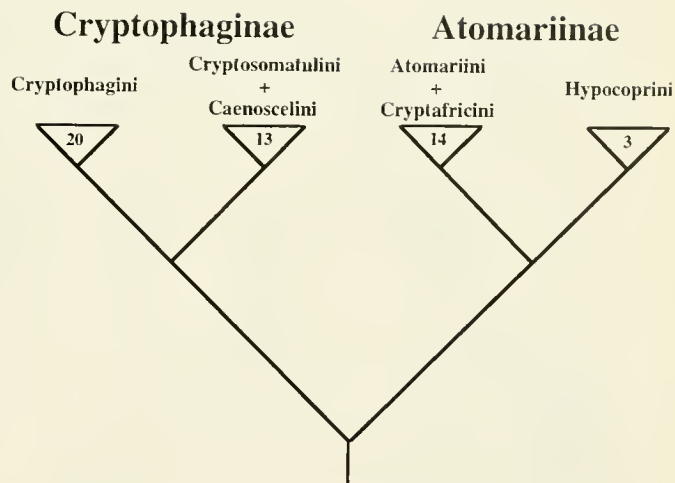

Fig. 2. Phylogenetic hypothesis for the beetle family Cryptophagidae. Numbers of genera are indicated in triangles representing higher taxa. The *Cryptophagus* group is a member of the tribe Cryptophagini.

then any study using it can be misleading. The phylogenetic relationships of the genera of Cryptophagidae were recently analyzed by Leschen (1996), and the phylogenies produced in that study are used here. Phylogenetic analyses based on parsimony and successive approximations character weighting (Farris, 1969; see also Carpenter, 1988, 1994) produced several competing cladograms. The main reason that many competing parsimonious constructions were produced, especially with regard to the tribe Cryptophagini, is many of the branches are supported by relatively few (one to three) synapomorphies. These parsimonious reconstructions are supported by clear synapomorphies that can be challenged by subsequent phylogenetic studies based on additional morphological, behavioral or molecular characters. A strict consensus tree of one set of trees produced by successive approximations character weighting is shown in Fig. 2. Some characters (diet and inquilinism, hind wing reduction or loss) used in my 1996 study and examined here were removed from the data matrix, and the analyses were rerun (Leschen, 1996) because of ambiguities in the coding of the character states. The different phylogenetic hypotheses resulting from these analyses for the *Cryptophagus* group are discussed in detail elsewhere (Leschen, 1996).

The study of character evolution requires that traits of interest be mapped onto terminal taxa to infer ancestral character states. Several statistical tests have been developed for analyzing characters within the context of phylogenies (Harvey and Pagel, 1991; Brooks and McLennan, 1991; Westneat, 1995), and there is some debate over the null models and their assumptions (Wenzel and Carpenter, 1994; Maddison, 1994; Wenzel, 1997). Homoplasy methods (Pagel, 1994) require that the traits in question occur

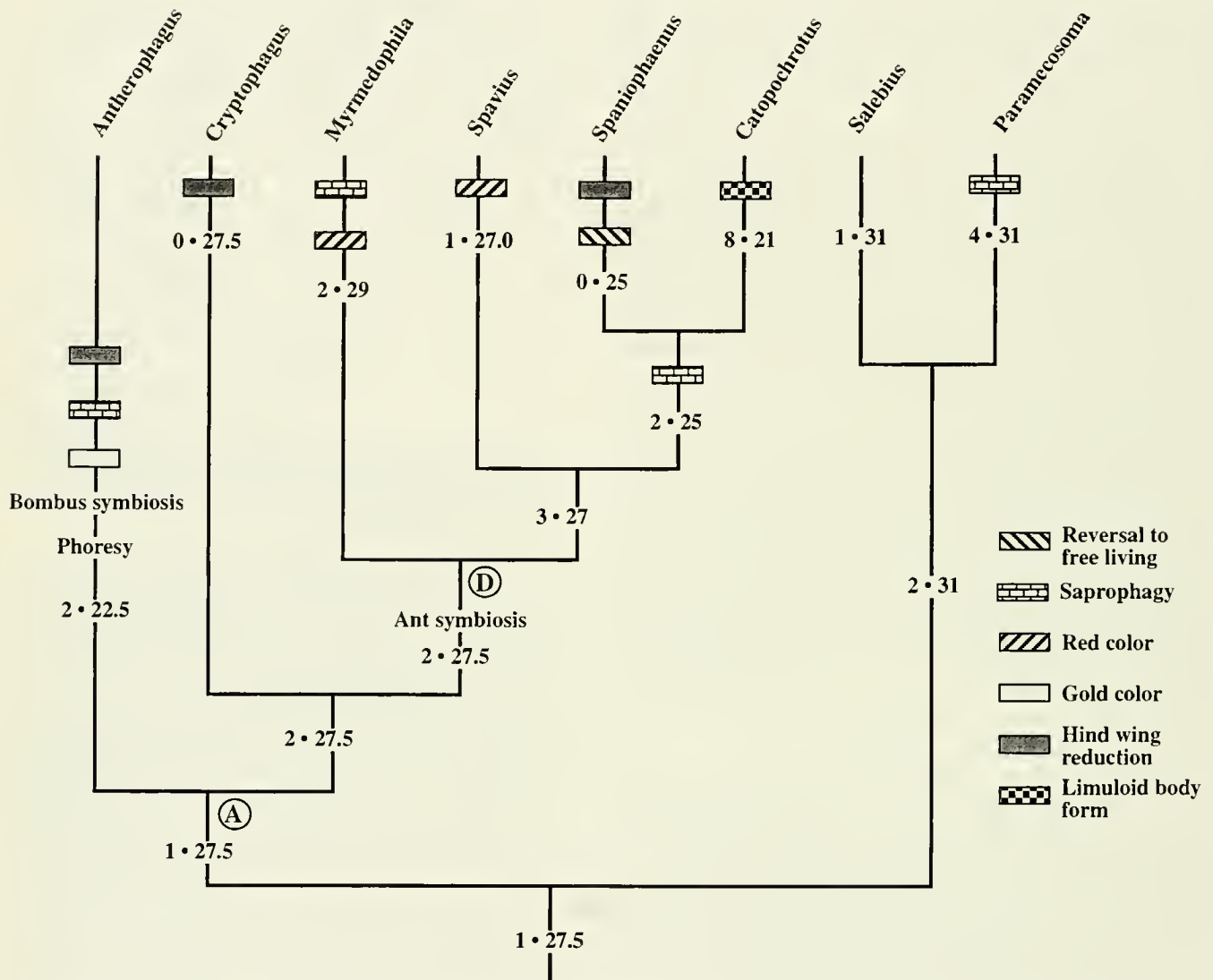

Fig. 3. Phylogenetic reconstruction of the *Cryptophagus* group (excluding *Micrambe* and *Henotimorphus*) based on Leschen (1996). Characters are mapped onto phylogeny using DELTRAN and hind wing reduction is polymorphic for all terminals. Numbers on branches are: branch length • no. of glandular ducts.

as multiple independent origins on the branches of reconstructed phylogenies. The frequency of convergent features as they appear in the trees is the basis for statistical analyses. In contrast, homology approaches (Coddington, 1994; Wenzel and Carpenter, 1994) are not statistical in nature but aim to understand character evolution as logical deductions of character changes based on cladograms. Although homoplasy and homology methods may demonstrate character correlation either statistically or logically, they may fail in explaining true adaptation which requires additional information (i.e., population structure, environmental or developmental data) external to tree topology (Coddington, 1988; Leroi et al., 1994; Wenzel and Carpenter, 1994). I use a homology approach in this paper to determine the origin and nature of shifts to symbiosis be-

cause actual (rather than simulated) distributions of data on phylogenetic trees better reflect the origins of symbiosis. Moreover, the traits of interest are relatively rare in *Cryptophagidae*, and there are many phylogenetic hypotheses to choose among for the relationships among members of the *Cryptophagus* group making statistical analyses cumbersome.

All possible parsimonious character mappings onto the cladogram shown in Fig. 3 (also see Leschen, 1996, Fig. 3) were investigated for determining character evolution (Maddison, 1994) by using the Equivocal Cycling option in MacClade (Maddison and Maddison, 1992). Both ACCTRAN and DELTRAN optimizations (Maddison et al., 1984) were used, and different resolutions of polytomous reconstructions (where necessary) were exam-

ined to construct character state graphs of inquiline host use. Total numbers of glandular ducts were mapped as continuously varying characters using maximum linear parsimony (Maddison and Maddison, 1992). Branch length was determined by counting the number of unambiguous character changes (Leschen, 1996, Fig. 3).

Polymorphic inquiline associations were coded in the data matrix as monomorphic units (Nixon and Davis, 1991) that represent total variation seen in the genus *Spaniophaeenus*. This genus contains individuals that are free-living or occur with two social insect hosts. It is represented by three terminal taxa and the trichotomy is resolved arbitrarily (not shown in figures). Hind wing loss or reduction, which is polymorphic in some taxa, was treated as a fixed polymorphic character state (1/0) for terminal taxa.

CHARACTER INTERPRETATION AND PATTERNS OF SYMBIOSIS

Different hypotheses about character state construction can lead to different interpretations of the evolution of that character (Pogue and Mickevich, 1990; Wilkinson, 1995). This problem is most difficult to resolve with ecological characters such as inquilinism because definitions are often axiomatic (Miller and Wenzel, 1995). Character states of inquilinism (as complex multistate characters) can be interpreted differently based on ecological context, taxonomic rank, and independence among character states resulting in three biologically explicit interpretations of homology. *Ecological inquilinism* is defined as cryptophagid symbiosis with ants, bees, and termites. These associations are assumed to be ecologically similar but may not be biologically independent (see below). This character consists of two states: free-living (0) and symbiotic (1). There are a variety of arguments against using taxon-based definitions for comparative studies of character evolution and species diversity (e.g., Doyle and Donoghue, 1993). Advocates of the phylogenetic approach strictly limit comparisons to monophyletic groups because taxonomic ranks are arbitrary assignments for categories that may or may not reflect monophyly. Biases due to rank of the inquiline host, as a character mapped onto a cladogram, may also affect evolutionary interpretation. There are two definitions used here for understanding the nature of symbiosis that reflect monophyly of the host taxa. *Taxon-specific inquilinism* (TSI) is defined as symbiosis only with ants (Formicidae), or bees (Apidae), or termites (Isoptera). These associations, as character states, represent independent character states equivalent to family- or ordinal-level monophyletic taxa. This character consists of four character states: free-living (0) or ant (1), bee (2), and termite associations (3). This character state interpretation most closely resembles the model

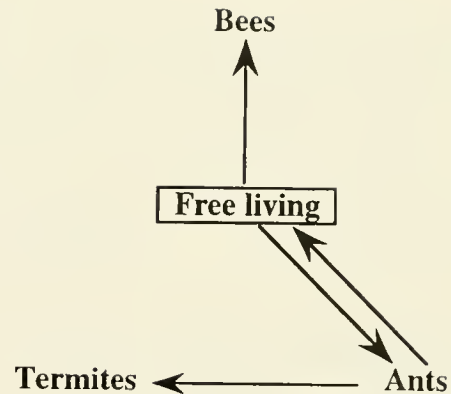

Fig. 4. A 4-step model for inquiline character states based on a taxonomic-specific interpretation (TSI) for homology and on tree in Fig. 3.

used by Leschen (1996) for his character number 114. *Host-specific inquilinism* (HSI) is defined as cryptophagid symbiosis with a specific genus or species of host. This definition, therefore, considers that each specific association is biologically independent. This character consists of six character states: free living (0) or *Anacanthotermes* (1), *Crematogaster* (2), *Bombus* (3), *Formica* (4), and *Messor* (5) associations.

It is unequivocal that the association with *Formica* is not homologous between members of *Hypocopus* and the *Cryptophagus* group because these taxa are distantly related and isolated in the cryptophagid phylogeny (Fig. 2). Character state transformations within the *Cryptophagus* group are considered in the following discussion.

Based on character optimizations, ecological inquilinism represents a 3-step model of character transition by ACCTRAN (one gain at A in Fig. 3 and two losses; one for *Cryptophagus* and the other within *Spaniophaeenus*) and DELTRAN (two gains, one for *Antherophagus* and at D in Fig. 3, and one loss within *Spaniophaeenus*). The number of colonization events may be underestimated due to the fact that cryptophagid inquilines use a variety of social insects as hosts and that each symbiotic association may have originated independently. A TSI definition of symbiosis produces a 4-step model (see character state graph in Fig. 4) of character change where bee inquilinism evolved once in *Antherophagus*, ant inquilinism evolved once at A in Fig. 3, termite inquilinism evolved once within *Spaniophaeenus*, and there was a single reversal back to free-living in *Spaniophaeenus* from an ancestral ant association. When symbiosis is based on an HSI interpretation (not shown), inquilinism evolved one or two times in *Formica*, and once in *Bombus*, *Crematogaster*, *Acanthotermes*, and *Messor*. The shift from *Formica* (in the ancestor of *Spavivus* + *Myrmedophila* using DELTRAN optimization) to *Crematogaster* (in *Catopochrotus*) is evidence for a shift that

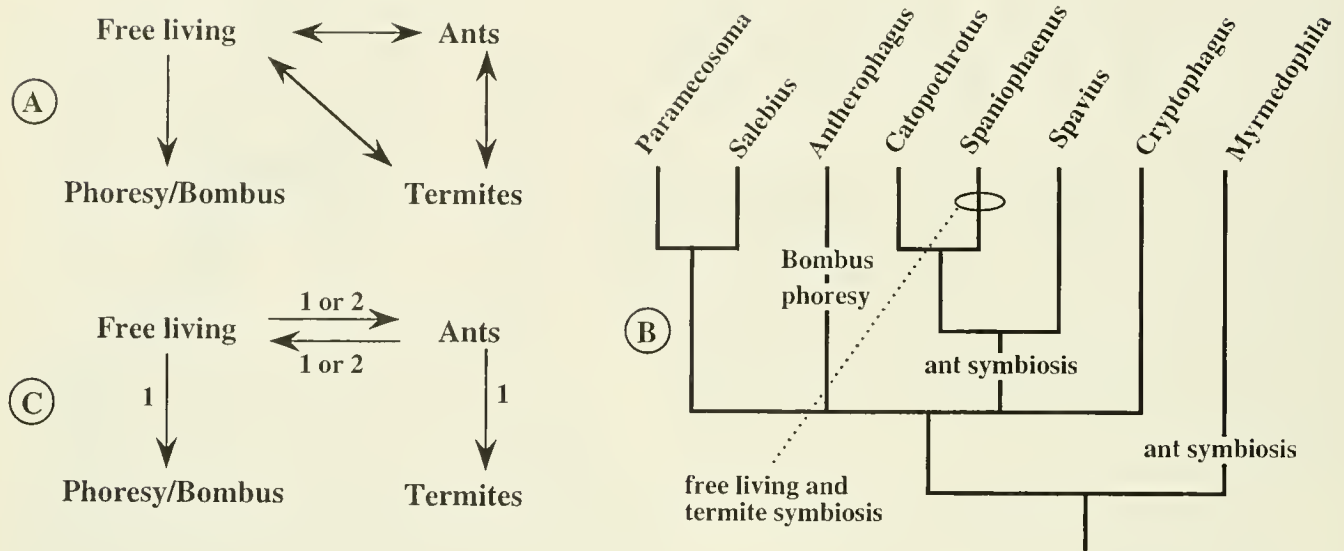

Fig. 5. Newly constructed character state transformations and phylogeny based on phoretic and nonphoretic symbiosis. A—Hypothetical character state graph. B—Phylogenetic reconstruction of the *Cryptophagus* group based on cladistic analysis that included character states in A. C—Character state graph based on reconstruction in B with number of transformations indicated at each transition.

has occurred in an association with ants although the ambiguous associations and phylogenetic relationships for the three *Spaniophaeenus* species may provide different hypotheses about the ancestral host association of *Catopochrotus* and *Spaniophaeenus*. The number of independent colonizations to inquilinism in this case may be overestimated if these character states are not independent and represent subsequent diversification within the context of inquilinism (see below).

What is particularly confusing is the fact that members of the *Cryptophagus* group use a variety of hosts and are closely related, complicating homology and exact determination of ancestral host associations. Moreover, the number of reconstructions employing TSI and HSI definitions increases significantly (3 and 22, respectively) due to an increase in number of character states and ambiguities in host reconstruction for each ancestor. If these symbiotic taxa were completely unrelated, separated by more than one step each, the origin of some of the character states could be easily interpreted as independent events with unambiguous ancestral behaviors despite different character state definitions. Choosing among the definitions for inquiline homology, based on rank or ecological relationship, does affect patterns observed and could be specified by the evolutionary question proposed. An ecological definition is useful in determining the origin of symbiosis over the entire cryptophagid cladogram while TSI and HSI definitions will address the frequency and nature of host shifts in localized areas of the cladogram. The ambiguities in TSI and HSI patterns could be interpreted as multiple hypoth-

eses for host-shifts subsequent to the origin of symbiosis. A general hypothesis for inquilinism in *Cryptophagidae* is as follows: Symbiosis has evolved repeatedly in *Cryptophagidae* (among *Cryptophagini* and *Hypocoprini*), and in the *Cryptophagus* group there were several shifts among unrelated social insect hosts.

Based on the available natural history information, members of *Anthrophagus* are phoretic on their hosts, while the remaining symbionts may fly directly to social insect nests. This fundamental difference in the form of symbiotic association implies that nonphoretic and phoretic symbiosis are not homologous and may represent two uniquely derived shifts to symbiosis. Therefore, ecological inquilinism may be subdivided into two homologous character transformations, (A) nonphoretic and phoretic inquilinism, while nonphoretic inquilinism (B) can be further divided into ant and termite associations. The 4-step character state graph is provided in Fig. 5A. The character state transformations were included as nonadditive characters in the original data matrix (substituting character 114), and an analysis was done (see methods in Leschen, 1996) as a test to evaluate the number of origins of inquilinism. This analysis resulted in 500 trees (Tree Length = 406, Consistency Index = 0.367, Retention Index = 0.740). In the strict consensus tree of these trees the *Cryptophagus* group consists of the basal taxon *Micrambe* Thomson as sister genus to a polytomy containing the remaining members and a monophyletic group composed of *Spavius* (*Spaniophaeenus*, *Catopochrotus*). Successive approximations character weighting (SAW) of these trees resulted in 15 trees

by two iterations, and a strict consensus of these is shown for the *Cryptophagus* group in Fig. 5B. Note that the relationships shown in Fig. 3 are similar to that shown in Fig. 5B if two internodes are collapsed and the tree is rooted at *Myrmedophila*.

Hypotheses about the evolution of inquilinism based on the newly produced SAW trees are as follows: *Bombus*/phoretic symbiosis evolved once, while nonphoretic symbiosis arose once with termites and once or twice with ants, while reversals to free-living occurred once or twice with ant associations (Fig. 5C). In all reconstructions *Bombus* associations originated once and did not occur within lineages of ant-symbiotic lineages, indicating that the two forms of inquilinism (nonphoretic and phoretic) are indeed independently derived. This pattern is also reflected in other phylogenies proposed by Leschen (1996). Choosing this 4-step model over previous models may be desirable because the additional information regarding phoresy has been used to illuminate an additional path to the evolution of symbiosis. However, this model assumes that all members of *Antherophagus* are phoretic (which may not be true; see Leschen, 1996) and the remaining symbionts fly directly to insect nests. The phoretic/nonphoretic hypothesis is equally parsimonious to the TSI interpretation, and these together provide more parsimonious interpretations for character evolution compared to the model based on an HSI definition.

HOST USE AND THE ORIGIN OF SYMBIOSIS

As is true for any affirmation of host relationship, larval associations, repeated collections and behavioral observations must be made to substantiate a symbiotic association. In most cases, these criteria have not been met in Cryptophagidae. Additional field data and direct behavioral observations are necessary to determine the nature of host associations. This is especially true for *Spaniophaeus* and *Hypocoprus*, for which there is very little known about natural history. None of the *Cryptophagus* species are true inquilines because these have been reported as stored product pests and in other habitats (Hinton, 1945; Horion, 1960; Koch, 1989). Moreover, larval records for some of the species of *Cryptophagus* (Table 1) were made in association with habitats other than social insect nests (see Leschen, 1996).

Current data reveal two classes of inquilines: obligate or facultative symbionts. Facultative symbionts are those taxa containing a mixture of species or populations that are free-living or symbiotic. Obligate inquilines are those taxa that contain populations that occur exclusively in association with social insect nests. While this simple scheme is useful, there are some limitations and phylogenetic implications for these classes. For example, if a facultative taxon contains more than two recognizable monophyletic

taxa, and the internal phylogenetic relationships are unknown, then the true phylogenetic pattern of symbiosis may be enigmatic. At the generic level, *Hypocoprus* and *Spaniophaeus* may be considered facultative inquilines because they contain a mixture of species or populations some of which are free-living and others symbiotic. The remaining taxa mentioned in the review are considered true inquilines.

Despite different theories about character transformation, inquilinism in its various forms has evolved in members of the *Cryptophagus* group, suggesting that this group is prone to some level of inquiline diversification. Moreover, because different interpretations of character states may increase the number of "origins," this pattern supports Wilson's (1971) view that some groups are more prone to inquilinism than others. Although causal factors promoting symbiosis in the *Cryptophagus* group remain obscure, a better understanding of specific host- or habitat-seeking behaviors may be useful to determine proximate mechanisms.

The nature of the shift from free-living to inquilinism may be revealed by comparing the microhabitats present in social insect nests to those microhabitats utilized by ancestral free-living and derived inquiline cryptophagids. Many *Bombus* bees build their nests in pre-existing rodent burrows (Michener, 1974), while *Acanthotermes* stores caches of plant foods (Artemev and Zhuzhikov, 1968), *Messor* (harvester ants) are seed gatherers, and *Formica* ants construct mounds of thatch-debris (Wilson and Hölldobler, 1990). Incidental associations of other free-living cryptophagid species with social insects may be based on collections made from abandoned nests or active nests with vacant portions that have decayed. These microhabitats promote fungal growth and could have attracted ancestral free-living cryptophagids that were mycophagous (a primitive behavior for the family) to abundant food resources present in social insect nests, facilitating the shift to inquilinism. Similarity among fungus-promoting microhabitats outside and in social insect nests supports a habitat similarity hypothesis for the evolution of inquilinism in Cryptophagidae.

The evolution of host-use in phytophagous and mycophagous insects can be understood by examining host suitability, preference, and encounter-frequency (Jeanike, 1990). It has been argued by Wilson (1971) that large populations of social insects may promote the evolution of symbiosis by creating abundant microhabitats in ecological communities. *Formica* ant colonies, for example, are very common in holarctic ecosystems and may have served as attractive microhabitats to the ancestors of cryptophagid inquilines. Therefore both habitat similarity and ecological opportunity may explain the occurrence of

cryptophagids in social insect nests as implied by Wilson (1971) and Kistner (1979) for other groups of inquilines. Shifts among unrelated hosts supports the hypothesis that similar ecologies, rather than genealogy, has influenced the origin of symbiosis in Cryptophagidae with social insects.

DIET AND MORPHOLOGICAL EVOLUTION ASSOCIATED WITH SYMBIOSIS

Character evolution of inquilines of the *Cryptophagus* group is considered in detail in this section. Character state reconstructions are mapped onto the resolved phylogeny shown in Fig. 3.

General classifications of inquiline behavior consider diet as one important indicator of behavioral integration into the host nest (Wasmann, 1894; Wilson, 1971). Liquid food obtained by trophallaxis between host and inquiline and food gleaned from host bodies are thought to be some of the important feeding mechanisms used by fully-integrated symbionts (Kistner, 1982; Hölldobler and Wilson, 1990). Although liquid diets are difficult to observe because gut squashes appear empty (Leschen, 1993), the guts of cryptophagid inquilines always appear to contain some material. This suggests that cryptophagid symbionts may not be fully integrated into their host nests to the degree seen in other symbiotic beetles that interact directly with their hosts. Empirical observations on symbiont and host interactions are necessary to support this presumption.

Leschen (1996) considered *Antherophagus* a pollen feeder because he observed guts of larvae and adults collected from *Bombus* nests are filled with pollen. However, this pollen originally collected by foraging *Bombus* is released as feces of the bee larvae among nest debris (Scott, 1920; Frison, 1921; Plath, 1922). Therefore, the diet of adults and larvae of *Antherophagus* in the nest is considered here as saprophagy, while the diet of adults collected on flowers remains unknown. Based on gut analysis, mycophagous and saprophagous diets occur in cryptophagid inquilines, while mycophagy is a primitive feature for Cryptophagidae (Leschen, 1996). Saprophagy arose at least three times independently in the *Cryptophagus* group (four gains or three gains and one reversal) and does not appear to be consistently correlated with shifts to symbiosis because of a single reversal to mycophagy (i.e., *Spavius*), and some free-living taxa are saprophagous (Leschen, 1996: *Mnionomidius* Reitter and *Striatocryptus* Leschen). Cryptophagid inquilines that have shifted from mycophagy to saprophagy in association with social insect nests may be ingesting suitable foods other than fungi (dead and moribund insects, debris in waste heaps, etc.). There are, however, biases associated with small sample sizes in the number of guts examined due to availability of specimens for dissection (Leschen, 1996). Saprophagy,

if viewed as a specialization in Cryptophagini, needs to be documented further.

There are several morphological features that are often observed in inquiline lineages (Kistner, 1982). The fact that these characters (head retracted into the prothorax, compact antennomeres, body color, etc.) do not consistently occur together in every inquiline lineage or species suggests that natural selection for these traits differs, depending on underlying phylogenetic history, developmental constraints, and specific host ecology and behavior. There are several unique features in some cryptophagid genera that could be correlated with inquilinism (e.g., clypeal notch of male *Antherophagus*); however, proving that these unique characters are true adaptations to symbiosis may be difficult (Coddington, 1988) without a better understanding of function (Lauder, 1981).

The majority of cryptophagid species are brown in color, in contrast, *Antherophagus*, *Myrmedophila*, and *Spavius* are red or gold and have a reduced vestiture of sparse setae. Red coloration has evolved once (DELTRAN optimization) or twice (ACCTAN optimization) and gold coloration is unique to *Antherophagus* spp. The coloration and vestiture in these beetles may be linked to chemical systems useful in obtaining specific colony odors or cuticular hydrocarbons of the host (Howard et al., 1980). Many inquilines that are known to have active hormonal systems also have characteristic cuticular modifications (SeEVERS, 1965; Kistner, 1982). Fig. 3 shows that the *Formica* inquilines *Myrmedophila* and *Spavius* are the only species that are red (but see Ljubarsky, 1992) and are separated by one step. This suggests that inquilines of *Formica* ants either share similar selective regimes for red coloration by convergence or common ancestry (homology). Members of *Hypocopus* differ in color from their analogous counterparts *Myrmedophila* and *Spavius* which refutes an adaptive coloration hypothesis for all species associated with *Formica*. Moreover, different phylogenetic results would also refute a homology hypothesis for red coloration in *Myrmedophila* and *Spavius* (e.g., see Fig. 5B).

Hind wing loss or reduction is a feature often discussed in the context of inquilinism (SeEVERS, 1965), especially in some beetle groups where dispersal to new nests occurs only by phoresy (e.g., Roubik and Wheeler, 1982). Wing reduction has at least four independent origins and is polymorphic for the terminal taxa of the *Cryptophagus* group. This character is probably not directly related to inquilinism in cryptophagids because it has evolved repeatedly in many free-living cryptophagine species and genera (Leschen, 1996: *Henoticus* Thomson, *Micrambe*, *Mnionomidius*, and *Mnioticus* Scott). Therefore, it is likely that wing loss is a function of resource abundance or habitat stability (Roff, 1990; Thayer, 1992) and not directly re-

lated to inquilinism *per se*. Inquilinism may be correlated with character evolution in *Antherophagus* where wing loss and eye reduction covary in tropical species that are strictly phoretic (Leschen, 1996). Additional behavioral data and species-level phylogenies are needed to fully understand the correlation of these traits.

Many inquiline beetles have special glands and trichomes that function in appeasement, behavioral duping of the host, and chemical mimicry (Kistner, 1979; Steidle and Dettner, 1993; Hölldobler and Wilson, 1990). Sometimes glandular systems already present in free-living ancestors may become more complex or simplified in symbionts (Steidle and Dettner, 1993). The simple cuticular glandular ducts of Cryptophagini are present at various positions on the body (Leschen, 1996). Curiously, the glandular ducts of cryptophagid inquilines have not undergone any of the complex changes in reservoir and delivery systems that have occurred in the glandular systems of some other inquilines (i.e., staphylinids, histerids, and others) in which duct openings may be furnished with elaborate trichomes for chemical release. If anything, some of the cryptophagine inquilines have a poorly-developed pronotal angularity and reduction also occurs in the lateral teeth on the pronotal carina which may be associated with symbiosis. However, angularity-reduction occurs in various free-living species of *Cryptophagus* and *Micrambe*. The overall cuticular morphology suggests that the chemical system in Cryptophagini was not co-opted for use in symbiosis, although detailed histological and chemical studies may show otherwise. The total number of glandular ducts present throughout the body in the *Cryptophagus* group varies from 20–31 (Leschen, 1996). This range does not appear to change drastically in phylogeny even though the ranges of glandular duct numbers in the symbiotic genera *Antherophagus* (20–25) and *Catopochrotus* (21) are below the mean in Cryptophagini (26.9). If a causal relationship truly exists, the number of glandular ducts must be shown to have some performance advantage, such as being linked to specific changes in behavior, or in response to differences in chemical ecology.

Inquilines are regarded as some of the strangest insect forms ever to have evolved, and it is conceivable that over the evolutionary course of an association with social insect hosts radical morphologies emerged as a response to tighter links to the host through behavioral interactions. Many authors have called attention to the highly modified body forms in inquiline groups that are purportedly used to dupe or mimic hosts to gain access into colonies and protect the inquiline from aggressive attacks from its host or visual predators. In beetles, especially staphylinids, there are two forms present (Seevers, 1965; Wilson, 1971; Kistner, 1979), one of which is present in Cryptophagidae. A "mimetic" form converges on the body

plan of the host to the extent that only a trained eye can discriminate host from beetle in the field. This body form does not exist in Cryptophagidae. Another form found in many beetle inquilines is a limuloid body form, which is present in the cryptophagid genus *Catopochrotus* (Fig. 1B). The limuloid body form conceals the appendages below by an expansion of lateral portions of the body.

Limuloidy has evolved repeatedly in several lineages of Coleoptera and other insects and it is thought to protect the insect from dorsal attacks during aggressive interactions between inquiline and host (Kistner, 1979; Hölldobler and Wilson, 1990). Among the morphological "grades" of inquilinism discussed by other authors, limuloidy is considered as one of the most advanced. Two phylogenetic hypotheses can be made about the origin of this body form. Limuloidy may evolve within an inquiline lineage either at the origin of symbiosis or some time thereafter. A grade of morphologies is evidence supporting the hypothesis that modified body forms evolved subsequent to the origin of symbiosis. Discrimination among these hypotheses can be made by examining where *Catopochrotus* occurs relative to other inquilines in the cryptophagid tree. *Catopochrotus crematogastris* is consistently placed as one of the most derived members (with its sister taxon *Spaniophenus*) of the *Cryptophagus* group, suggesting that limuloidy may not necessarily be an important pre-adaptation for the evolution of inquilinism to occur. Moreover, the similarity between the remaining obligate inquilines with *Cryptophagus* supports the view that over time more "adaptive" and divergent morphologies evolve as lineages remain integrated. This is supported by the number of character changes present on branches of the phylogenetic tree (Fig. 3), where *Catopochrotus* has eight terminal changes (four losses and four gains—see Leschen, 1996) and the branch lengths of the remaining terminal taxa and ancestors of the *Cryptophagus* group range from one to four. This apparent latent shift in the acceleration rate of morphological change has occurred after the origin of symbiosis. The morphological evolution in *Catopochrotus*, however, may be a specific response to its host and not at all related to the general phenomenon of inquilinism. This may also be true for the phoretic genus *Antherophagus*, which also has a number of unique features that may be related to inquilinism. Also, comparisons among branch lengths are biased with respect to taxonomic rank (comparisons made among genera) and do not consider character changes that are associated with cladogenetic events occurring within each genus (Doyle and Donoghue, 1993).

RATES OF SPECIATION AND BIOGEOGRAPHY

Changes in the speciation rate among groups of monophyletic taxa is perhaps the most intriguing and least un-

derstood evolutionary question concerning biologists (Sanderson and Donoghue, 1995). While some explanations emphasize factors intrinsic to each clade, such as key innovations correlated with entry into new adaptive zones (Simpson, 1944, 1953; Leim, 1974; Ricklefs and Schluter, 1993), or differences of niche breadth (Vrba, 1988; Eldredge, 1989), other explanations emphasize extrinsic factors such as climatic and geological changes, which may also create differences in diversity among monophyletic groups of taxa (Nelson and Platnick, 1981; Wiley, 1981; Cracraft, 1985).

Paramount to understanding phylogenetic patterns are well-resolved phylogenies for hosts and inquilines, well-documented data on social insect hosts, and estimates of rates of divergence (either geologic or molecular-based). Cryptophagid fossils are rare; the best preserved fauna that has probably been correctly identified are those specimens recorded from Baltic amber and dated as Oligocene (Spahr, 1981). In this fauna there are several genera, including *Antherophagus*, *Cryptophagus*, *Micrambe* and *Spavius*, suggesting that the ecological associations for the *Cryptophagus* group are at least 30 my old.

The evolution of inquilinism in Cryptophagidae did not accompany major radiations (number of species per monophyletic lineage) as it has in other groups containing inquilines, such as Staphylinidae or Histeridae. None of the inquilines has a high number of species relative to the diverse taxa *Cryptophagus* and *Micrambe* with 200 and 80 species, respectively (Leschen, 1996). This pattern may be related to relatively recent evolution of the majority of inquilines subsequent to the branching event separating *Cryptophagus* from other taxa in many of the phylogenetic reconstructions (Fig. 3). On the other hand, *Antherophagus* is more diverse than the remaining genera of cryptophagid inquilines and is also a relatively basal member in the *Cryptophagus* group. The number of species in *Antherophagus* may be the result of an early divergence relative to other members of the *Cryptophagus* group rather than an association with social insects. It is curious that despite an estimated historical association for 30 my there has been a relatively slow rate of speciation in inquiline lineages.

By comparing the phylogenies of several staphylinid inquiline groups, Kistner (1979) elucidated four phylogenetic patterns of host use and speciation rates. Kistner's major points (patterns) are: 1) speciation in inquilines occurs faster than in the host lineage; 2) host shifts or transfers in inquiline lineages appear to be associated with slower speciation rates while 3) lineages that maintain host fidelity have higher rates of speciation; and 4) "incomplete" host specificity or broad host use may increase rates of speciation. In all cases the number of cryptophagid in-

quiline species is far less than the number of species contained in the host genera (e.g., compare the number of cryptophagid species to the number of host species in Michener [1974] for bees and Hölldobler and Wilson [1990] for ants) which seems to refute Kistner's first point. On the other hand, a relatively slow rate of evolution may be related to the amount of host-shifting present in the *Cryptophagus* group. For *Antherophagus*, current data for host-use (Table 1) suggests that some species are generalists on *Bombus* species while maintaining an exclusive association with the genus. Clearly, the data for Cryptophagidae do not verify all of Kistner's (1979) hypotheses, but his study may be relevant only to those groups of Staphylinidae he studied.

Cryptophagid inquilinism appears to be limited to those groups occurring in the Holarctic, and while there is a growing body of literature about the biogeographical affinities in this geographical region (Enghoff, 1995) few phylogenetic studies refer to symbiotic associations spanning this area (although insect/host-plant examples exist, see Moran, 1982; Mitter and Farrell, 1991). There are several symbionts limited to *Formica* in the Holarctic (Kistner, 1982; Wilson, 1971), and Wasmann (1906) suggested that the three staphylinid genera in the Lomochusina originated in Europe and later evolved with their respective *Formica* hosts in the Holarctic. There may have been a vicariant event marking the separation of *Spavius* and *Myrmedophila* (at least in trees showing that these may be closely related) consistent with the separation of North America from Eurasia that is also present in lomochusine staphylinids (if the association with *Formica* is primitive). This pattern may also hold true for the association of *Hypocopus* with *Formica*. Host fidelity, therefore, is preserved in phylogenetic history that includes large-scale vicariant events in *Formica* symbionts.

Another case in host fidelity is *Antherophagus*, which is completely sympatric with its host *Bombus*. Most *Bombus* species are found in the Holarctic region (Michener, 1974), although there are some species occurring in tropical areas in the Old World and New World that represent subsequent dispersal, assuming that *Bombus* originated in the Holarctic. If *Antherophagus* has tracked the evolution of *Bombus* bees, then species phylogenies of both *Antherophagus* and *Bombus* may be concordant. No clear pattern exists for host associations when *Antherophagus* species are mapped onto the preliminary phylogeny of *Bombus* provided by Williams (1985). Fully resolved phylogenies for *Antherophagus* and *Bombus* are necessary to address this hypothesis.

In conclusion, knowledge about the natural history and evolution of symbiosis in Cryptophagidae is in its infancy. Behavioral observations are certainly necessary, es-

pecially of larval associations that indicate oviposition preferences. Because of alternative phylogenies for the *Cryptophagus* group (Leschen, 1996) that provide many equally probable hypotheses for patterns of character evolution, choosing among these hypotheses is difficult. Leschen (1996) acknowledged that the *Cryptophagus* group is a systematic mess. A complete understanding of the phylogenetic relationships of the group hinges on a comprehensive consideration of the morphological variation within the genus *Cryptophagus*.

LITERATURE CITED

- Akre, R. D. and C. W. Rettenmeyer. 1966. Behavior of Staphylinidae associated with army ants (Formicidae: Ecitonini). *Journal of the Kansas Entomological Society* 39: 745–782.
- Artemev, M.M. and D.P. Zhuzhikov. 1968. Food collection and feeding in *Anacanthotermes algerianus* Jacobs. (Isoptera, Hodotermitidae). Pp. 74–78, in Luppova, A.N. (ed.) *Termites and Control Measures Against Them*. Proceedings of the 2nd All-Union Conference on the Study of Termites and Their Control. [in Russian]
- Bernard, F. 1968. *Les fourmis (Hymenoptera Formicidae) d'Europe occidentale et septentrionale* (Faune de l'Europe et du Bassin Méditerranéen, no. 3). Paris, Masson et Cie. 411 pp.
- Bold, T.J. 1856. Note on *Antherophagus nigricornis* and *Bombus sylvorum*. *Zoologist* 14: 5003.
- Bolton, B. 1995. *A New General Catalogue of the Ants of the World*. Cambridge, Harvard University Press. 504 pp.
- Bousquet, Y. 1989. A review of the North American genera of Cryptophaginae (Coleoptera: Cryptophagidae). *Coleopterists Bulletin* 43: 1–17.
- Brooks, D.R. and D.H. McLennan 1991. *Phylogeny, Ecology, and Behavior: a Research Program in Comparative Biology*. Chicago, University of Chicago Press. 434 pp.
- Bugnion, E. 1869–70. (Letter to E. Perris on *Antherophagus*). *L'Abiella* 7: 26–27.
- Buckle, C. W. 1900. Beetles collected in Lough Foyle District, Cos. Donegal and Derry. *Irish Naturalist* 9: 2–11.
- Carpenter, J. M. 1988. Choosing among multiple equally parsimonious cladograms. *Cladistics* 4: 291–296.
- Carpenter, J. M. 1994. Successive weighting, reliability and evidence. *Cladistics* 10: 215–220.
- Chaudoir, M. 1845. Notices entomologiques sur le gouvernement et la ville de Kiew. *Bulletin de la Société Impériale des Naturalistes de Moscou* 18: 158–213.
- Chavarría, G. 1994a. Phoresy on a neotropical bumblebee (Hymenoptera: Apidae) by *Antherophagus* (Coleoptera: Cryptophagidae). *Psyche* 101: 109–111.
- Chavarría, G. 1994b. First neotropical mutualistic associations in bumblebee nests (Hymenoptera: Apidae). *Psyche* 101: 112–118.
- Coddington, J. A. 1988. Cladistic tests of adaptational hypotheses. *Cladistics* 4: 30–22.
- Coddington, J. A. 1994. The roles of homology and convergence studies in studies of adaptation. Pp. 53–78, in Eggleton, P. and R. I. Vane-Wright (eds.) *Phylogenetics and Ecology*. New York, Academic Press.
- Coombs, C. W. and G. E. Woodroffe. 1955. A revision of the British species of *Cryptophagus* (Herbst) (Coleoptera: Cryptophagidae). *Transactions of the Royal Entomological Society, London* 106: 237–282.
- Cottam, R. 1909. *Antherophagus pallens* in Derbyshire, Lancs. *Naturalist* 2: 266.
- Cracraft, J. 1985. Biological diversification and its causes. *Annals of the Missouri Botanical Garden* 72: 794–822.
- Crowson, R. A. 1955. *The Natural Classification of the Families of Coleoptera*. London, Nathaniel Lloyd and Co. 187 pp.
- Crowson, R.A. 1980. On amphipolar distribution patterns in some cool climate groups of Coleoptera. *Entomologia Generalis* 6: 281–292.
- Cumber, R.A. 1949. Humble-bee parasites and commensals found within a thirty mile radius of London. *Proceedings of the Entomological Society of London (ser. A)* 24: 119–127.
- de Pinna, M.C.C. 1991. Concepts and tests of homology in the cladistic paradigm. *Cladistics* 7: 367–394.
- Dettner, K. and C. Leipert. 1994. Chemical mimicry and camouflage. *Annual Review of Entomology* 39: 129–154.
- Dollman, H. 1912. Coleoptera taken at Ditchling, Sussex, during 1911. *The Entomologists Record* 24: 20–23.
- Donisthorpe, H. 1904. Coleoptera in the New Forest. *The Entomologists Record* 16: 325–326.
- Donisthorpe, H. 1909. On the colonisation of new nests of ants by myrmecophilous Coleoptera. *Transactions of the Entomological Society of London* 1909: 413–29.
- Donisthorpe, H. 1920. The phoresy of *Antherophagus*. *Entomologists Record* 32: 181–187.
- Doyle, J. A. and M.J. Donoghue. 1993. Phylogenies and angiosperm diversification. *Paleobiology* 19: 141–167.
- Eichelbaum, F. 1907. Die Larven von *Cis festivus* Panz. und von *Emphyllus glaber* Gyll. *Zeitschrift für wissenschaftliche Insekten-Biologie* 3: 25–30.
- Eichhoff, O. 1866. *Sammelberichte*. *Berliner Entomologische Zeitschrift* 10: 293–295.
- Eldredge, N. 1989. *Macroevolutionary Dynamics: Species, Niches, and Adaptive Peaks*. New York, McGraw-Hill. 226 pp.
- Enghoff, H. 1995. Historical biogeography of the Holarctic: area relationships, ancestral areas, and dispersal of non-marine animals. *Cladistics* 11: 223–263.
- Falcoz, L. 1929. Tableaux analytiques des coléoptères de la faune Franco-Rhénane (France, Hollande, Belgique, Région rhénane, Valais): Famille 33: Cryptophagidae. *Miscellanea Entomologique* 31–32: 1–197.
- Farris, J.S. 1969. A successive approximations approach to character weighting. *Systematic Zoology* 18: 374–385.
- von Frisch, K. 1952. Hummeln als unfreiwillige Transportflieger. *Natur und Volk* 82: 171–174.
- Frison, T.H. 1921. *Antherophagus ochraceus* Melsh. in the nests of bumblebees. *The American Naturalist* 45: 188–192.
- Frison, T.H. 1926. Contribution to the knowledge of the interactions of the bumblebees of Illinois with their animate environments. *Annals of the Entomological Society of America* 29: 226–230.
- Gorham, H. S. 1869. *Leptinus* in bee's nests. *Entomologists Monthly Magazine* 6: 89.
- Grandi, G. 1936. Contributi all conoscenza degli Imenotteri Aculeati. XV. *Bollettino dell' Instituto di Entomologia dell' R. Università degli Studi di Bologna* 8: 27–121 + 4 pls.
- Grouvelle, A. 1911a. Description d'un *Antherophagus* de Java et de la larve (Coleoptera: Cryptophagidae). *Notes Leyden Museum* 33: 117–120.
- Grouvelle, A. 1911b. Coléoptères cryptophagides recueillis au Mexique par M.L. Digue dans les nids du *Bombus ephippiatus* Say. *Bulletin Museum Histoire Naturelle, Paris* 1911: 97–100.
- Harvey, P.H. and M.D. Pagel. 1991. *The Comparative Method in Evolutionary Biology*. Oxford, Oxford, University Press. 239 pp.
- Hempel, C. G. 1966. *Philosophy of Science*. Foundations of Philosophy Series. Toronto, Prentice Hall. 116 pp.
- Hinton, H. E. 1945. *A Monograph of the Beetles Associated with Stored Products*. Vol. I. British Museum (Natural History), London. 443 pp.

- Hölldobler, B. and E. O. Wilson. 1990. *The Ants*. Cambridge, Harvard University Press. 732 pp.
- Horion, A. 1960. *Faunistik der mitteleuropäischen Käfer*. Band VII: Clavicornia. Teil 2. (Sphaeritidae bis Phalacridae). Teredilia, Coccinellidae. Überlingen, A. Feyel, xiii + 375 pp.
- Howard, R. W., C.A. McDaniel, and G.J. Blomquist. 1980. Chemical mimicry as an integrating mechanism: cuticular hydrocarbons of a termitophile and its host. *Science* 210: 431–433.
- Husband, R.W. and T.M. Brown. 1976. Insects associated with Michigan bumblebees (*Bombus*). *The Great Lakes Entomologist* 9: 57–62.
- Jeanike, J. 1990. Host specialization in phytophagous insects. *Annual Review of Ecology and Systematics* 21: 243–273.
- Johnson, C. 1993. *Provisional atlas of the Cryptophagidae-Atomariinae (Coleoptera) of Britain and Ireland*. Huntington, Biological Records Centre. 91 pp.
- Joy, N. H. 1932. *A practical handbook of British beetles*. 2 vols. London, Witherby. 622 pp.
- Kato, M., S. Salmah, and T. Nagamitsu. 1992. Colony cycle and foraging activity of a tropical-montane bumblebee, *Bombus rufipes* (Hymenoptera, Apidae) in Southeast Asia. *Japanese Journal of Entomology* 60: 765–776.
- Kieseritzky, V. and A. Reichardt. 1936. Zur Frage über die Selbständigkeit der Familie Catopochrotidae, im Zusammenhang mit der Entdeckung einer neuen Gattung. *Trudy Zoologicheskogo Instituta Akademii Nauk SSSR* 3: 693–697 [in Russian and Latin].
- Kistner, D. H. 1979. Social and evolutionary significance of social insect symbionts. Pp. 339–413, in H. R. Hermann (ed.), *Social Insects*, Vol. I. New York, Academic Press.
- Kistner, D. H. 1982. The social insects' bestiary. Pp. 361–423, in H. R. Hermann (ed.), *Social Insects*, Vol. III. New York, Academic Press.
- Koch, K. 1989. *Die Käfer Mitteleuropas, Ökologie*, Band 2. Krefeld, Goecke and Evers. 382 pp.
- Lauder, G. V. 1981. Form and function: structural analysis in evolutionary morphology. *Paleobiology* 7: 430–442.
- Leim, K. F. 1974. Evolutionary strategies and morphological innovations: Cichlid pharyngeal jaws. *Systematic Zoology* 22: 425–441.
- Leroi, A.M., M. R. Rose, G.V. Lauder. 1994. What does the comparative method reveal about adaptation. *American Naturalist* 143: 381–402.
- Leschen, R. A. B. 1993. Evolutionary patterns of feeding in selected Staphylinidae (Coleoptera): shifts among food textures. Pp. 59–104, in C.W. Schaefer and R. A. B. Leschen (eds.), *Functional Morphology of Insect Feeding*. Thomas Say Publications in Entomology: Proceedings of the Entomological Society of America.
- Leschen, R.A.B. 1996. Phylogeny and revision of the genera of Cryptophagidae (Coleoptera: Cucujoidea). *University of Kansas Science Bulletin* 55: 549–634.
- Ljubarsky, G. Y. 1992. On the taxonomical status of the genera *Myrmedophila* Bousquet, 1989 and *Catopochrotides* Kies. and Rchdt., 1936 (Coleoptera, Cryptophagidae). *Entomologicheskoye Obozrenie* 71: 595–598 [in Russian; translation in *Entomological Review* 72: 28–31, 1993].
- Maddison, D.R. 1994. Phylogenetic methods for inferring the evolutionary history and processes of change in discretely valued characters. *Annual Review of Entomology* 39: 267–292.
- Maddison, W. P. 1990. A method for testing the correlated evolution of two binary characters: are gains or losses concentrated on a certain branch of a phylogenetic tree? *Evolution* 44: 539–557.
- Maddison, W. P. and D. R. Maddison. 1992. *MacClade: Analysis of Phylogeny and Character Evolution*. version 3. Sunderland, Sinauer.
- Maddison, W. P., Donoghue, M. J., and D. R. Maddison. 1984. Outgroup analysis and parsimony. *Systematic Zoology* 33: 83–103.
- Meer Mohr, J. C. van der and M. A. Liefinck. 1947 (1945). Over de biologie van *Antherophagus ludekingi* Grouv. (Col.) in hommelnesten (*Bombus* Latr.) op Sumatra. *Tijdschrift voor Entomologie* 88: 207–214.
- Michener, C. D. 1974. *The Social Behavior of Bees: A Comparative Study*. Cambridge, Harvard University Press. xii + 404 pp.
- Mickevich, M. F., and S. J. Weller. 1990. Evolutionary character analysis: tracing character change on a cladogram. *Cladistics* 6: 137–170.
- Miller, J.S. and J.W. Wenzel. 1995. Ecological characters and phylogeny. *Annual Review of Entomology* 40: 389–415.
- Mitter C. M. and B. Farrell. 1991. Macroevolutionary aspects of insect-plant relationships. Pp. 35–78, in E.A. Bernays (ed.), *Insect/plant Interactions*, vol. 3. Boca Raton, Florida, CRC Press.
- Moran, N. 1989. A 48-million-year-old aphid—host plant association and complex life cycle: biogeographic evidence. *Science* 245: 173–175.
- Motschulsky, V. 1844. Bemerkungen zu dem im V^{ten} Bande der Zeitschrift für die Entomologie p. 192 von H.^{rn} Mærkel gegebenen "Beiträge zur Kenntniss der unter Ameisen Lebenden Insekten." *Bulletin de la Société Impériale des Naturalistes de Moscou* 17: 812–823.
- Nixon, K. C. and J. I. Davis. 1991. Polymorphic taxa, missing values and cladistic analysis. *Cladistics* 7: 233–241.
- Otero, J. C. and J. A. Díaz-Pazos. 1995. Revision of the genus *Spaniophaeus* Reitter, 1875 (Coleoptera: Cryptophagidae). *Koleopterologische Rundschau* 65: 183–188.
- Packard, A. S. 1864. The bumble-bees of New England and their parasites, with notes of a new species of *Antherophorabia*, and a new genus of Proctotrupidae. *Proceedings of the Essex Institute* 4: 107–140.
- Page, M. 1994. The adaptationist wager. Pp. 29–51, in Eggleton, P and R.I. Vane-Wright (eds.). *Phylogenetics and Ecology*. New York, Academic Press.
- Pogue, M. C. and M. F. Mickevich. 1990. Character definitions and character state delineation: the bête noire of phylogenetic inference. *Cladistics* 6: 319–361.
- Perris, E. 1869–1870. Notes on *Antherophagus nigricornis*. *L'Abeille* 7: 9–10, 25–27.
- Perris, M. E. 1876 (1875). *Larves de Coléoptères*. Annales de la Société Linnéenne de Lyon. 590 pp. + 14 pls.
- Plath, O.E. 1922. Notes on the nesting habits of several North American bumblebees. *Psyche* 29: 189–202.
- Reitter, E. 1875. Revision der europäischen Cryptophagen. *Deutsch Entomologische Zeitschrift* 19: 1–86.
- Reitter, E. 1889. Zwei neue Coleopteren-Gattungen aus Transkaukasien. *Wiener Entomologische Zeitung* 8: 289–292, + pl. IV.
- Ricklefs, R.E. and D. Schluter. *Species Diversity in Ecological Communities: Historical and Geographical Perspectives*. Chicago, The University of Chicago Press. 414 pp.
- Roff D.K. 1990. The evolution of flightlessness in insects. *Ecological Monographs* 60: 389–421.
- Roubik, D W. and Q. D. Wheeler. 1982. Flightless beetles and stingless bees: phoresy of scotocryptine beetles (Leiodidae) on their meliponine hosts (Apidae). *Journal of the Kansas Entomological Society* 55: 125–135.
- Sanderson, M. J. and M. J. Donoghue 1994. Shifts in diversification rate with the origin of Angiosperms. *Science* 264: 1590–1593.
- Schwarz, E.A. and H. Ulke. 1891. [Notes on *Emphylyus americanus*]. *Proceedings of the Entomological Society of Washington* 11: 227.
- Scott, H. 1920. Notes on the biology of some inquiline and parasites in a nest of *Bombus derhamellus* Kirby; with a description of the larva and pupa of *Epuraca depressa* Illig. (= *aistiva* Auctt.: Coleoptera, Nitidulidae). *Transactions of the Entomological Society of London* 1920: 99–127.
- Seevers, C.H. 1957. A monograph on the termitophilous Staphylinidae (Coleoptera). *Fieldiana: Zoology* 40: 1–334.
- Seevers, C.H. 1965. The systematics, evolution and zoogeography of staphylinid beetles associated with army ants (Coleoptera,

- Staphylinidae). *Fieldiana: Zoology* 47: 139–351.
- Seidlitz, G. 1869–70. (Note on *Antherophagus nigricornis*). *L'Abielle* 7: 62–63.
- Simpson, G.G. 1944. *Tempo and Mode in Evolution*. New York, Columbia University Press. 247 pp.
- Simpson, G.G. 1953. *The Major Features of Evolution*. New York, Columbia University Press. 434 pp.
- Smith, J.B. 1909. Annual report of the New Jersey State Museum, including reports on the Insects of New Jersey. Trenton, MacCrellish and Quigley.
- Smith, F. 1855. Catalogue of the British Hymenoptera, Part I. Apidae - bees. London, Taylor and Francis. 252 pp. + 10 plts.
- Spahr, U. 1981. Systematischer Katalog der Bernstein- und Kopal- Käfer (Coleoptera). *Stuttgarter Beiträge Naturkunde (Ser. B: Geologie und Paläontologie)* 80: 1–107.
- Steidle, J.L.M. and K. Dettner. 1993. Chemistry and morphology of the tergal gland of freeliving Aleocharinae (Staphylinidae, Coleoptera). *Systematic Entomology* 18: 149–168.
- Thayer, M.K. 1992. Discovery of sexual wing dimorphism in Staphylinidae (Coleoptera): "*Omalium*" *flavidum*, and a discussion of wing dimorphism in insects. *Journal of the New York Entomological Society* 100: 540–573.
- Trautmann, G. 1915. Ein äusserst seltener Fund: *Antherophagus*, Latr. *nigricornis*, Fabr., an einer lebenden Hummel. *Internationale Entomologische Zeitschrift Guben* 9: 59.
- Tuck, W. H. 1896. Inquiline and other inhabitants in nests of Aculeate Hymenoptera. *Entomologists Monthly Magazine* 32: 153–155.
- Tuck, W. H. 1897. Coleoptera, etc., in nests of Aculeate Hymenoptera. *Entomologists Monthly Magazine* 33: 58–60.
- Vrba, E.S. 1980. Evolution, species and fossils: How does life evolve? *South African Journal of Science* 66: 61–84.
- Wasmann, E. 1894. *Kritisches Verzeichniss der myrmecophilen und termitophilen Arthropoden. Mit der Lebensweise und mit Beschreibungen neuer Arten*. Berlin, Felix L. Dames. 231 pp.
- Wasmann, E. 1906. Beispiele rezenter Artenbildung bei Ameisengästen und Termitengästen. *Biologisches Zentralblatt* 26: 565–580.
- Wenzel, J.W. and J.M. Carpenter. 1994. Comparing methods: adaptive traits and tests of adaptation. Pp. 79–101, in Eggleton, P. and R. I. Vane-Wright (eds.), *Phylogenetics and Ecology*. New York, Academic Press.
- Wenzel, J.W. 1997. When is a phylogenetic test good enough? Pp. 31–45, in Grandcolas, P. (ed.). *The Origin of Biodiversity in Insects*. Mémoires Museum Histoire Naturelle no. 173.
- Wheeler, W. M. 1919. The phoresy of *Antherophagus*. *Psyche* 26: 145–152.
- Wheeler, W.M. 1910. *Ants: Their Structure, Development and Behavior*. New York, Columbia University Press. xxv + 663 pp.
- Westneat, M. 1995. Feeding, function, and phylogeny: analysis of historical biomechanics in labrid fishes using comparative methods. *Systematic Biology* 44: 361–383.
- Wiley, E. O. 1981. *Phylogenetics: The Theory and Practice of Phylogenetic Systematics*. New York, J. Wiley and Sons. 439 pp.
- Williams, P. H. 1985. A preliminary cladistic investigation of relationships among bumble bees (Hymenoptera, Apidae). *Systematic Entomology* 10: 239–255.
- Wilkinson, M. 1995. A comparison of two methods of character construction. *Cladistics* 11: 297–308.
- Wilson, E.O. 1971. *The Insect Societies*. Cambridge, Harvard University Press. 548 pp.

Timing of Mating Flights of Neotropical African and European Honey Bee Queens and Drones (Hymenoptera: Apidae) in Eastern Venezuela

By

GARD W. OTIS^{1,2}, ORLEY R. TAYLOR, JR.³, MARLA SPIVAK⁴, MARK L. WINSTON⁵,
SUSAN J. KATZ⁵, AND PENELOPE F. KUKUK⁶

ABSTRACT Mating flight characteristics of reproductives of neotropical African and European honey bees (*Apis mellifera* L.) were studied in eastern Venezuela. For queens, mean exit times of all flights and midpoints of mating flights differed significantly between the subspecies, with the midpoints of mating flights by European queens occurring an average of 47 min earlier in the afternoon. Queens of the two subspecies did not differ in other aspects of their orientation and mating flights. Flights of European drones also occurred significantly earlier than those of neotropical African drones. Mating flights of queens and drones of the same subspecies were approximately synchronous. These results are sufficient to explain the weak positive assortative mating that has been reported previously.

Key Words: Neotropical African bees; *Apis mellifera*; Assortative mating; Drone; Honey bee; Queen; Mating.

INTRODUCTION

The introduction of African honey bees (*Apis mellifera scutellata*) to South America has resulted in the remarkable colonization by their descendants of a vast area from Argentina to the southern United States. Prior to 1956, only honey bees of European origin (EHBs) had been imported into Latin America (Winston, 1992; Rinderer et al., 1993). However, as the introduced African bees became established, the characteristics of feral and managed honey bees suggested that their drones predominated in matings with both managed EHBs and feral neotropical African honey bee (NAHB⁷) queens (Nogueira-Neto, 1964; Hellmich et al., 1988; Taylor and Rowell, 1988; Hall, 1990; Taylor et al., 1991; Echazarreta, 1993; Taylor, in press), although more slowly or to a lesser extent in areas with high populations of EHBs (Rinderer et al., 1991; Quezada-Euan and Hinsull, 1995). These studies suggest that NAHB drones have a mating advantage. Factors which may contribute to this advantage include greater production of drones by NAHB colonies (Rinderer et al., 1987; Spivak, 1992; Echazarreta, 1993), seasonal differences in the production of drones (Echazarreta, 1993), longer and/or more mating flights by NAHB drones (Echazarreta, 1993), possible suppression of drone production in EHB colonies by NAHB drone para-

sitism (Rinderer et al., 1985; Rinderer and Hellmich, 1991), and differences in the spatial (Rowell and Taylor, 1988; Taylor and Rowell, 1988) and temporal (Hellmich and Collins, 1990; Hellmich et al., 1991; Collins and Mbaya, 1994) distributions of queens and drones of each subspecies at the time of mating.

In contrast, Kerr and Bueno (1970) reported no mating advantage of NAHB drones when NAHB and EHB queens mated in an isolated site containing equal numbers of NAHB and EHB drones. They found that Italian queens mated with Italian drones (64.8% of matings), and NAHB queens with NAHB drones (58.5% of matings), more often than would be expected if mating were random. Their results clearly indicated weak positive assortative mating, but the behavior underlying the phenomenon was not evident.

Based on several sets of unpublished observations (some reported here), Taylor (1985) stated that there is a difference in the timing of mating flights of EHB and NAHB drones. Hellmich and associates confirmed that EHB drones generally flew earlier in the day than did NAHB drones in western Venezuela (Hellmich, 1987; Hellmich and Collins, 1990; Hellmich et al., 1991). They reported a difference of 17–19 min in mean flight times,

¹ Department of Environmental Biology, University of Guelph, Guelph, ONT, N1G 2W1, CANADA. E-mail: gotis@evbhort.uoguelph.ca

² Address for correspondence.

³ Department of Entomology, University of Kansas, Lawrence, KS 66045.

⁴ Department of Entomology, University of Minnesota, St. Paul, MN 55108.

⁵ Department of Biological Sciences, Simon Fraser University, Burnaby, BC, V5A 1S6, CANADA.

⁶ Division of Biological Sciences, University of Montana, Missoula, MT 59812.

⁷ We use the term "African" honey bee to refer to *A. m. scutellata* imported from South Africa and Tanzania. Following terminology suggested in Page's (1989) title, we have called the descendants of African bees introduced into the New World "neotropical African" honey bees (NAHBs). For convenience, we refer to NAHBs and European honey bees (EHBs) as "subspecies."

with the difference greater for immature than for mature drones. In southern Texas, all drones flew much later in the day in mid-summer than in spring, and the differences between the two subspecies were less pronounced (Collins and Mbaya, 1994). Preliminary studies by one of us (PFK) as early as 1977 indicated a subspecific difference in the timing of queen mating flights as well. Partial temporal segregation of the mating flights of EHB and NAHB drones combined with the synchronization of queen and drone flights within each subspecies might explain the results of Kerr and Bueno (1970). The only published data for queens indicated that their flight distributions differ significantly between the two subspecies, but also documented unexpectedly poor synchrony between EHB queens and drones (Hellmich and Collins, 1990).

In this study we compare the characteristics of mating flights of queens and drones of EHBs and NAHBs, provide further documentation of the temporal segregation between the subspecies, and discuss the importance of our results with respect to the assortative mating reported by Kerr and Bueno (1970) and the "Africanization" of honey bees in tropical America.

ACKNOWLEDGMENTS

This paper is dedicated in memory of our colleague and friend, Byron Alexander. Byron's unselfish assistance to his students and colleagues was highly valued and will be missed.

We wish to thank the Ministerio de Agricultura y Cria de Venezuela for providing lodging, a vehicle, equipment, and some of the bees, and Ricardo Gomez for his assistance and hospitality. Nestor Alvarez, Abbie Zeltzer, and Gary Pundt assisted with the field work. Don Hamilton assisted with figure preparation and Debbie MacDonald typed earlier versions of this manuscript and the tables. We appreciate the constructive feedback of Dawn Bakker, Judy Wearing-Wilde, and four anonymous reviewers. This research was supported by USDA Cooperative Agreement 58-7B30-8-7 and Research Agreement 12-14-7001-363 (to ORT), and a grant from Idaho State University (to MLW).

MATERIALS AND METHODS

Observations of mating flights were made at a field station maintained by the Ministerio de Agricultura y Cria de Venezuela, at Laguna Grande, 16 km E of Maturin, Monagas, Venezuela (9°47'N, 63°4'W). Data for queens were obtained from 29 April to 21 July 1980. Daylength during this period ranged from 12h 25 min to 12h 39 min. Temperatures during the flight times were 26–35°C, winds were generally light (<2m/sec), and cloud cover ranged from clear to overcast in the afternoons. Observations on several days toward the end of this period were interrupted by rains.

Several procedural steps assured that queens of both subspecies were observed under similar conditions. All queens being observed at any one time were reared together using standard queen-rearing techniques. Consequently, the resulting virgin queens were approximately the same age (although NAHB queens develop slightly more rapidly; DeGrandi-Hoffmann et al., 1998). Five sets of these queens were established sequentially in mating nuclei. Each set consisted of two NAHB and two EHB colonies observed simultaneously by two observers.

The EHB queens (n=10) were daughters of Italian stocks (8 queens from two different commercial producers) and a Carniolan stock (2 queens) imported from the USA. The virgin NAHB queens (n=10) were reared from a stock established from feral colonies that exhibited worker cell size (diameter: 4.6–5.0 mm; see summaries by Rinderer et al., 1986, and Spivak et al., 1988), morphological traits (small size, all black abdominal tip), and behavioral characteristics (e.g., rapid movement on combs) typical of NAHBs. The NAHB colonies were maintained in a site >60 km from the nearest apiaries that may have contained EHBs, in order to minimize possible influences of EHBs on our NAHB stock.

Queen cells or virgin queens <48 h post adult emergence were introduced into 5-frame nucleus colonies of 3,000–5,000 bees of the same race. The virgin queens either eclosed directly into the colonies or were allowed to emerge into tubular wire cages from which they were released 1–2 d after emergence. The entrance of each hive was reduced and fitted with a clear plastic tube 2.5 cm in diameter affixed to a landing platform 10 cm wide which facilitated observations of queens. Beginning when queens were <5 d old, and continuing until queen flights had ceased for at least 2 d, we observed each colony from 13:00–17:00 h (except during rains) and recorded all flights. Because queen flights were not restricted in any way, continuous observation was required, which limited the number of queens for which we could obtain data. Following the convention established by others (e.g., Oertel, 1940; Roberts, 1944; Ruttner, 1985), we distinguished mating flights either by the presence of a "mating sign" attached to the queen or by a flight duration of >10 min. In our study, only 2 of the 26 queens that returned with a mating sign took flights that lasted less than 10 min, and only one flight (18 min duration) was scored as a mating flight in the absence of a mating sign. For some variables the number of observations per queen was unequal; in these instances we computed averages for each queen prior to calculating the overall means and Student's *t*-values. The two values for sample size we report indicate the number of queens and the total number of flights that provided information for the analysis.

Table 1. Comparison of mating and non-mating flights of European (EHB) and neotropical African (NAHB) queens in eastern Venezuela. Data represent means \pm standard deviations; sample sizes in parentheses indicate the number of queens for which data were obtained and the total number of flights. Statistical probabilities represent the results of Student's *t*-tests.

	EHB Queens	NAHB Queens	P
Exit times for all flights	14:44 h \pm 26.9 min (10, 47)	15:19 h \pm 26.3 min (9, 54)	< 0.02
Mid point of mating flights	15:11 h \pm 24.5 min (9, 17)	15:58 h \pm 32.7 min (6, 10)	< 0.01
Age of 1st flight	6.6 \pm 1.74 days (9)	6.5 \pm 2.14 days (8)	> 0.9
Age at 1st mating	8.0 \pm 2.27 days (8)	9.2 \pm 2.86 days(6)	> 0.5
Number of mating flights per queen	2.1 \pm 0.38 (7, 15)	1.6 \pm 0.55 (5, 8)	> 0.05
Total number of flights per queen	5.6 \pm 3.05 (8, 42)	6.3 \pm 3.96 (7, 47)	> 0.5
Age of queen when mating	9.5 \pm 3.77 days (9, 18)	9.8 \pm 2.81 days(6, 10)	> 0.9
Duration of non-mating flights	6.0 \pm 2.36 min (9, 22)	5.0 \pm 3.12 min (9, 40)	> 0.4
Duration of mating flights	14.5 \pm 4.74 min (9, 17)	17.2 \pm 2.54 min (6, 10)	> 0.2

Table 2. Summary of mean drone flight times determined at four time periods in eastern Venezuela.

Date	Method of Data Collection	European	Neotropical African	Difference
1-20 January 1980	Trapping of marked drones	15:11 h (n=2,336)	15:35 h (n=6,520)	24 min
March-April 1980	Trapping of yellow and black drones	15:38 h (n=3,563 yellow)	16:07 h (n=6,078 black)	28 min
13-25 June 1980	Departures of marked drones	14:57 h (n=289)	15:35 h (n=240)	38 min
20 March 1981	Trapping of marked drones	15:59 h (n=181)	16:20 h (n=209)	21 min

Data on the timing of drone flights were obtained in several ways. The most relevant data set was obtained between 13-25 June 1980, approximately midway through our observations of queen mating flights. Sealed drone brood from NAHB and EHB colonies was incubated at 34 ± 1 °C. Newly emerged drones (0-24 h old) were color-marked with Testors® paint to designate subspecies and date of emergence, and were added to queenright colonies of the same subspecies. They were 7-19 d old during the period in which we quantified the exit times of their flights.

The largest data set for flights by drones of known subspecies was obtained in January 1980. Following the above procedure, we marked 6,520 NAHB and 2,336 EHB drones (i.e., all that were available) and introduced them to colonies of their own subspecies between 5 December 1980 and 13 January 1981. From the numbers of marked drones in the colonies, we estimated that 50-70% of the drones were accepted by the colonies to which they were introduced. Drones were subsequently trapped in several drone congregation areas (DCAs) 0.6-3.4 km from the drone-holding colonies, using an aerial drone trap (Taylor, 1984a). Trapping occurred on 15 afternoons between 1-20 January. We recorded the midpoint of the capture interval and the age and subspecies of all marked drones.

On 20 March 1981, data for another set of marked NAHB and EHB drones aged 7-11 d were obtained in a

DCA located 900 m from the drone-holding colonies. Drones were trapped as described in the preceding paragraph.

Finally, unmarked drones were trapped in DCAs on numerous afternoons in March and April 1980. About 97% of NAHB drones were completely black in color, whereas only about 10% of European drones were black in this population. The slight overlap in color of NAHBs and EHBs results in slight underestimation of the subspecific differences. For this data set we had a large sample size (3,563 yellow drones; 6,078 black drones).

All data are reported in local Venezuelan time (GMT - 4 h) unless otherwise noted.

RESULTS

A comparison of mating flights of EHB and NAHB queens is presented in Table 1. EHB queens (n=10 queens, 47 flights) departed on all flights (orientation and mating combined) an average of 35 min earlier ($p < 0.02$) than NAHB queens (9 queens, 54 flights). The difference in the mean timing of mating was 47 min and highly significant ($p < 0.01$; EHB: 9 queens, 17 mating flights; NAHB: 6 queens, 10 mating flights). The midpoints of each mating flight are plotted at the bottom of Fig. 1. In other characteristics of orientation and mating flights, queens of the two subspecies did not differ (Table 1).

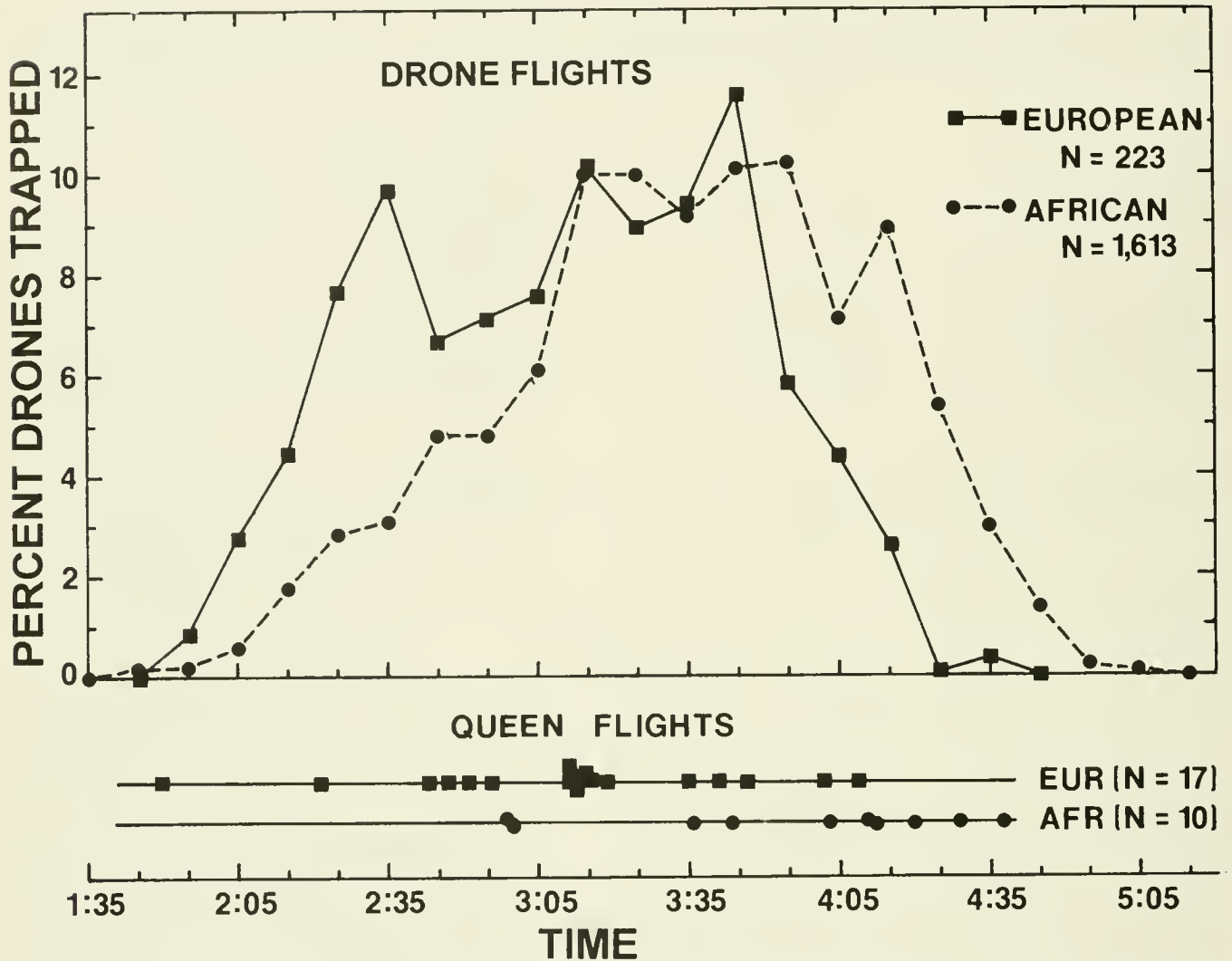

Fig. 1. Temporal distributions of mating flights by queens and drones of European and neotropical African honey bees near Maturin, Venezuela. The drone flight distribution (above) was obtained by combining the data for all marked drones of known race trapped between 1–20 January 1980, in several drone congregation areas 0.6–3.4 km from the experimental apiary. Mean capture times were 15:11 h (EHB) and 15:35 h (NAHB). The midpoints of each queen mating flight obtained between 29 April–21 July 1980, are plotted (below). Mean queen flight times are 15:11 h (EHB) and 15:58 h (NAHB). The time scale applies to distributions for both drones and queens.

The pattern of drone flights was similar on all days of observation. Drones of both subspecies often started and stopped flying at approximately the same times. However, the number of EHB drones at DCAs increased more rapidly and peaked earlier than for NAHB drones, resulting in differences of 21–38 min in the mean times of drone flights. The top part of Fig. 1 demonstrates this partial segregation of the drone flight distributions of EHB and NAHB drones (data from drones trapped in DCAs between 1–20 January 1980). Overlying this general pattern were seasonal differences in the timing of drone flights (Table 2). Mean times of flights in January and June occurred at about

the same hour relatively early in the day. In contrast, in March/April, during the height of the hot, windy dry season, the distributions of drone flights shifted to 30–50 min later in the day.

Within each subspecies, queen and drone mating flights were synchronized. For EHBs, the mean times of departure of queens (= 15:03 h) and drones (= 14:57 h, June data) from hives were very similar. Similar synchrony was observed for NAHB reproductives (queen departure: = 15:47 h; drone departure: = 15:35 h). Note that data for drones may include orientation flights which tend to occur earlier in the flight period.

DISCUSSION

We observed a substantial temporal difference (47 min) between the subspecies in the mean midpoint of queen mating flights. Similar differences between EHB and NAHB queens were recorded by Hellmich and Collins (1990) in western Venezuela during the dry season (56 min; calculated from data in their figure) and by one of us (PFK, unpublished observations) in French Guiana during the dry season (42 min). Taken together, these results demonstrate differences in the temporal pattern of mating behavior by the two types of queens and their colonies at each of the sites. The timing of queen mating flights also varies substantially as a function of seasonal environmental conditions. For example, the mean mating flight times (solar times) of queens we recorded in eastern Venezuela during the early rainy season (EHB: 14:59 h; NAHB: 15:46 h; daylength 12 h 38 min) were approximately 40 min earlier than those recorded by Hellmich and Collins (1990) in the dry season in western Venezuela (EHB: 15:34 h; NAHB: 16:31 h; daylength 12 h 3 min). (For this comparison only, local times were converted to solar times by subtracting 4 min for each 1° west of longitude 60°W).

Mating flights of EHB drones occur earlier in the day than those of NAHB drones, as also shown by Hellmich and Collins (1990), Hellmich et al. (1991), and Collins and Mbaya (1994). However, the magnitude of the difference in mean flight times recorded for drones of the two subspecies is less than that for queens, particularly under windier (dry season, Venezuela) and/or hotter (summer, Texas) climatic conditions (21–38 min, Table 2; 19 min, Hellmich et al., 1991; 17 min, calculated from Hellmich and Collins, 1990, Fig. 1; 18 min, calculated from partial March data of Collins and Mbaya, 1994; 5 min, calculated from June/July data of Collins and Mbaya, 1994). Some of the influences of daylength, temperature, winds, overcast skies and rain on mating flights are discussed by Alber et al. (1955), Taber (1964), Verbeek (1976), Fletcher and Tribe (1977), Jung (1981), and Lensky and Demter (1985).

During our period of queen observation, mating flights of queens and drones of the same subspecies were synchronized. Others have commented on the coincidence of queen and drone mating flights within populations (reviewed by Koeniger, 1991; see also Verma et al., 1990; Yoshida et al., 1994; and Yoshida, 1995). Such synchrony is to be expected because selection should favor queens that take mating flights at times of high drone abundance, resulting in fewer or shorter mating flights and therefore lower rates of predation as a consequence (Hellmich and Collins, 1990). Because synchrony should result from selection on both sexes, males should be selected to take mating flights when queens are available for mating. Our data from the early wet season showing synchrony within

each subspecies in queen and drone flights do not agree with the dry season observations of Hellmich and Collins (1990). There are no obvious explanations for this discrepancy between our results and theirs, or for the lack of synchrony in European queen and drone flights that they reported.

Partial temporal segregation to the extent we observed, combined with synchronization of queen and drone flights within each subspecies and with equal numbers of EHB and NAHB drones, can account for the positive assortative mating demonstrated by Kerr and Bueno (1970). A change in any of these three parameters will influence the degree to which one subspecies is favored in mating. Several other variables could influence this phenomenon, but our research suggests that they are relatively unimportant. For example, there is no obvious spatial separation of EHB and NAHB drones; when trapping drones, drones of both subspecies were either present or absent at any particular location, and their proportions were approximately the same at different DCAs (ORT and GWO, unpublished data). There is no apparent preference of drones for queens of their own subspecies; drones of each subspecies mated with plastic tubes containing confined queens that were suspended in a DCA (Taylor, 1984b) at the same frequency as they were trapped in flight (Taylor, 1984a) in the same DCA (ORT, unpublished observations). No one has evaluated mate choice by honey bee queens.

The results of Kerr and Bueno (1970) relate to a population-level phenomenon. They estimated mating frequencies (64.8% EHB × EHB matings; 58.5% AHB × AHB matings) based on characteristics of worker progeny of many queens. In that study, the Italian queens mated with an average of 5.3 males. Most of the EHB queens they studied mated with both EHB and NAHB drones. Relatively few EHB queens would be predicted to mate exclusively with EHB (e.g., $0.648^{5.3} = 10.0\%$) or AHB ($0.352^{5.3} = 0.4\%$) drones (although they obtained both these extreme results). Examination of Figure 1 clarifies this phenomenon. European queens flying early would encounter a preponderance of European drones; late-flying queens would encounter predominantly Africanized drones. On average, however, the partial temporal separation of flights by European and Africanized reproductives would result in positive assortative mating, but only to a relatively small extent because the distributions overlap broadly.

Unlike the experimental conditions of Kerr and Bueno (1970), NAHB drones available for mating usually greatly outnumber EHB drones in tropical regions. The factors that influence the relative proportions of NAHB and EHB drones encountered by queens (e.g., higher rates of drone production, earlier drone production, more mating flights, longer mating flights, and greater population size of

NAHBs; Rinderer et al., 1987; Winston, 1992; Echazarreta, 1993) influence matings of queens much more than the minor temporal difference between the subspecies in the timing of mating. In this regard we reached the same conclusion as Hellmich et al. (1991). However, we do not agree with the simplified prediction of Hellmich et al. (1991) that mixed mating between EHBs and NAHBs will necessarily lead to gene flow, the complete mixing of their genomes over time, and eventual homogenization of their mating flight distributions. The historical evidence from tropical regions (Sheppard et al., 1991a; Hall, 1992) and studies showing hybrid dysfunction (Harrison and Hall, 1993) do not favor the racial mixture hypothesis. More likely outcomes are the complete replacement of one race by the other in most regions (Smith, 1991; Hall, 1992) and the establishment of relatively permanent hybrid zones (Sheppard et al., 1991b; Taylor, in press).

LITERATURE CITED

- Alber, M., R. Jordan, F. Ruttner, and H. Ruttner. 1955. Von der Paarung der Honigbienen. Zeitschrift für Bienenforschung 3: 1–28. [German, German summary]
- Collins, A. M. and J. S. K. Mbaya. 1994. Drone flight times in South Texas: AHB and EHB. American Bee Journal 134: 830.
- DeGrandi-Hoffmann, G., J. C. Watkins, A. M. Collins, G. M. Loper, J. H. Martin, M. C. Arias, and W. S. Sheppard. 1998. Queen development time as a factor in the Africanization of European honey bee (Hymenoptera: Apidae) populations. Annals of the Entomological Society of America 91: 52–58.
- Echazarreta, C. M. 1993. *The Biology and Reproductive Behaviour of Africanized and European Honey Bee Drones (Apis mellifera L.) in Tropical Yucatan Mexico*. Ph.D. Thesis, University of Wales College of Cardiff, UK. 258 pp.
- Fletcher, D. J. C. and G. D. Tribe. 1977. Natural emergency queen rearing by the African bee *A. m. adansonii* and its relevance for successful queen production by beekeepers. II. Pp. 161–168 in D. J. C. Fletcher (ed.), *African Bees: Taxonomy, Biology and Economic Use*. Pretoria, Apimondia.
- Hall, H. G. 1990. Parental analysis of introgressive hybridization between African and European honey bees using nuclear DNA RFLPs. Genetics 125: 611–621.
- Hall, H. G. 1992. DNA studies reveal processes involved in the spread of New World African honey bees. Florida Entomologist 75: 51–59.
- Harrison, J. F. and H. G. Hall. 1993. African-European honeybee hybrids have low nonintermediate metabolic capacities. Nature 363: 258–260.
- Hellmich, R. L. 1987. Flight time differences between Africanized and European drones: implications for controlling matings. American Bee Journal 127: 846.
- Hellmich, R. L. II and A. M. Collins. 1990. A nuptial disadvantage for European honey bees in Venezuela. Pp. 141–142, in G. K. Vereesh, B. Mallik, and C. A. Viraktamath (eds.), *Social Insects and the Environment*, Proceedings of the 11th International Congress of the International Union for the Study Social Insects, 1990. New Delhi, Oxford and IBH.
- Hellmich, R. L. II, A. M. Collins, R. G. Danka, and T. E. Rinderer. 1988. Influencing matings of European honey bee queens in areas with Africanized honey bees (Hymenoptera: Apidae). Journal of Economic Entomology 81: 796–799.
- Hellmich, R. L. II, T. E. Rinderer, R. G. Danka, A. M. Collins, and D. L. Boykin. 1991. Flight times of Africanized and European honey bee drones (Hymenoptera: Apidae). Journal of Economic Entomology 84: 61–64.
- Jung, G. 1981. Climate and mating. Bienenvater 102: 71–74 (Apicultural Abstract #840/82). [In German]
- Kerr, W. E. and D. Bueno. 1970. Natural crossing between *Apis mellifera adansonii* and *Apis mellifera ligustica*. Evolution 24: 145–148.
- Koeniger, G. 1991. Diversity in *Apis* mating systems. Pp. 199–212, in D. R. Smith (ed.), *Diversity in the Genus Apis*. Boulder, Westview Press.
- Lensky, Y. and M. Demter. 1985. Mating flights of the queen honey bee (*Apis mellifera*) in a subtropical climate. Comparative Biochemistry and Physiology 81A: 222–241.
- Nogueira-Neto, P. 1964. The spread of a fierce African bee in Brazil. Bee World 45: 119–127.
- Oertel, E. 1940. Mating flights of queen bees. Gleanings in Bee Culture 68: 292–293, 332–333.
- Page, R. E., Jr. 1989. Neotropical African bees. Nature 339: 181–182.
- Quezada-Euan, J. J. G. and S. M. Hinsull. 1995. Evidence of continued European morphometrics and mtDNA in feral colonies of honey bees (*Apis mellifera*) from the Yucatán Peninsula, Mexico. Journal of Apicultural Research 34: 161–166.
- Rinderer, T. E., A. M. Collins, R. L. Hellmich II, and R. G. Danka. 1987. Differential drone production by Africanized and European honey bees. Apidologie 18: 61–67.
- Rinderer, T. E. and R. L. Hellmich II. 1991. The processes of Africanization. Pp. 95–117, in M. Spivak, D. J. C. Fletcher, and M. D. Breed (eds.), *The "African" Honey Bee*. Boulder, Westview Press.
- Rinderer, T. E., R. L. Hellmich II, R. G. Danka, and A. M. Collins. 1985. Male reproductive parasitism: a factor in the Africanization of European honey bee populations. Science 228: 1119–1121.
- Rinderer, T. E., B. P. Oldroyd, and W. S. Sheppard. 1993. Africanized bees in the U.S. Scientific American 269 (6): 84–90.
- Rinderer, T. E., J. A. Stelzer, B. P. Oldroyd, S. M. Bucu, and W. L. Rubink. 1991. Hybridization between European and Africanized honey bees in the neotropical Yucatan Peninsula. Science 253: 309–311.
- Rinderer, T. E., H. A. Sylvester, M. A. Brown, J. D. Villa, D. Pesante, and A. M. Collins. 1986. Field and simplified techniques for identifying Africanized and European honey bees. Apidologie 17: 33–48.
- Roberts, W. C. 1944. Multiple mating of queen bees proved by progeny and flight tests. Gleanings in Bee Culture 72: 255–259, 303.
- Rowell, G. A. and O. R. Taylor, Jr. 1988. Some computer simulations using the neutral mating model for the honey bee, *Apis mellifera*. Pp. 184–192, in G. R. Needham, R. E. Page, M. Delfinado-Baker, and C. E. Bowman (eds.), *Africanized Honey Bees and Bee Mites*. Chichester, Ellis Horwood, Ltd.
- Ruttner, F. 1985. Reproductive behaviour in honey bees. Pp. 225–236, in B. Hölldobler and M. Lindauer (eds.), *Experimental Behavioral Ecology and Sociobiology*. Sunderland, Sinauer Associates, Inc.
- Sheppard, W. S., A. E. E. Soares, D. DeJong, and H. Shimanuki. 1991a. Hybrid status of honey bee populations near the historic origin of Africanization in Brazil. Apidologie 22: 643–652.
- Sheppard, W. S., T. E. Rinderer, J. A. Mazzoli, J. A. Stelzer, and H. Shimanuki. 1991b. Gene flow between African- and European-derived honey bee populations in Argentina. Nature 349: 782–784.
- Smith, D. R. 1991. African bees in the Americas: insights from biogeography and genetics. Trends in Ecology and Evolution 6: 17–21.
- Spivak, M. 1992. The relative success of Africanized and European honeybees over a range of life-zones in Costa Rica. Journal of Applied Ecology 29: 150–162.
- Spivak, M., T. Ranker, O. R. Taylor, Jr., W. Taylor, and L. Davis. 1988. Discrimination of Africanized honey bees using behavior, cell size, morphometrics, and a newly discovered isozyme polymorphism. Pp.

- 313–324, in G. R. Needham, R. E. Page, Jr., M. Delfinado-Baker, and C. E. Bowman (eds.), *Africanized Honey Bees and Bee Mites*. Chichester, Ellis Horwood, Ltd.
- Taber, S. 1964. Factors influencing the circadian rhythm of drone honey bees. *Annals of the Entomological Society of America* 57: 769–775.
- Taylor, O. R., Jr. 1984a. An aerial trap for collecting drone honey bees in congregation areas. *Journal of Apicultural Research* 23: 18–20.
- Taylor, O. R., Jr. 1984b. A mating tube for studying attractiveness of queen honey bees and mating behaviour of drones. *Journal of Apicultural Research* 23: 21–24.
- Taylor, O. R., Jr. 1985. African bees: potential impact in the United States. *Bulletin of the Entomological Society of America* 31: 15–24.
- Taylor, O. R., Jr. In press. Displacement of European honeybee (*Apis mellifera*) subspecies by an invading African subspecies in the Americas. In L. J. Connor and R. Hoopingarner (eds.), *Beekeeping in the 21st Century*. Cheshire, CT., Wicwas Press.
- Taylor, O. R., A. Delgado, and F. Brizuela. 1991. Rapid loss of European traits from feral neotropical African honey bee populations. *American Bee Journal* 131: 783–784.
- Taylor, O. R., Jr. and G. A. Rowell. 1988. Drone abundance, queen flight distance, and the neutral mating model for the honey bee, *Apis mellifera*. Pp. 173–183, in G. R. Needham, R. E. Page, Jr., M. Delfinado-Baker, and C. E. Bowman (eds.), *Africanized Honey Bees and Bee Mites*. Chichester, Ellis Horwood, Ltd.
- Verbeek, B. 1976. Untersuchungen der Ausflugsaktivität von jungen Bienenköniginnen unter Festlands und Inselbedingungen Mittels lichtelektronischer Überwachung. *Apidologie* 7: 151–168. [German, German summary]
- Verma, L. R., B. S. Rana, and V. K. Mattu. 1990. Mating behaviour of *Apis cerana* Fabr. and *Apis mellifera* Linn. in the Simla Hills of the north-west Himalayas. *Journal of Insect Science* 3: 130–132.
- Winston, M. L. 1992. The biology and management of Africanized honey bees. *Annual Review of Entomology* 37: 173–193.
- Yoshida, T. 1995. Comparative studies on the mating system of Japanese honeybee, *Apis cerana japonica* Radoszkowski and European honeybee *Apis mellifera* L. (Hymenoptera: Apidae). *Bulletin of the Faculty of Agriculture, Tamagawa University* 35: 159–208.
- Yoshida, T., J. Saito, and N. Kajigaya. 1994. The mating flight times of native *Apis cerana japonica* Radoszkowski and introduced *Apis mellifera* L. in sympatric conditions. *Apidologie* 25: 353–360.

Eickwortia (Apoidea: Halictidae), a New Genus of Bees from Mesoamerica

By

RONALD J. MCGINLEY¹

ABSTRACT A new generic name, *Eickwortia*, is proposed for *Halictus nycteris* Vachal, and a new species of this taxon, *E. alexanderi*, is described. *Eickwortia* has been rarely collected and is known from only 69 specimens taken at high elevations from central Mexico to Costa Rica. Morphological characteristics and limited biological data suggest these bees may be social, and possibly wood-nesting. Suggestions for future collecting and research priorities are offered.

Keywords: *Eickwortia*; Apoidea; Halictidae; Bees; *Lasioglossum*.

INTRODUCTION

Vachal (1904) described *Halictus nycteris* based on a syntype series of eight females collected at Orizaba, Veracruz, Mexico, by Biart in 1862. It has remained enigmatic for nearly a century. J.S. Moure visited the Paris Museum, where the type series is deposited, and wrote (Moure and Hurd, 1987): "One female from Orizaba (Biar, 1862), Mexico was labeled as the lectoholotype in March, 1958, by one of us (Moure) and is now so designated. Dr. George C. Eickwort, who has examined the lectoholotype, informs us that this species appears to represent a new genus near *Neocorynura*." Eickwort kindly provided me with a copy of his 1975 notes from the Paris Museum, which include the following entry: "H. nycteris V. female holotype + 4 females. n.g. near *Neocorynura*. homotype Berkeley." Eickwort later recognized (pers. comm., 1986) that *H. nycteris* was not an augochlorine but still thought it represented a new genus of Halictini, near *Evyllaenus*. Eickwort and I had planned to co-designate a new genus for *H. nycteris*, but his untimely passing in 1994 prevented this action. It is in his honor that I propose this new generic name. In addition, a new species of this taxon is described in honor of the late Byron A. Alexander.

ACKNOWLEDGMENTS

Posthumous thanks go to George Eickwort who shared his opinions with me regarding the systematic status of this taxon. Eickwort also assembled a valuable collection of specimens, including a specimen compared to the type series. After Dr. Eickwort's death, Michael S. Engel and Douglas A. Yanega alerted me to the existence of this homotype in the Cornell University Collection. Dr. Yanega also kindly sent me SEM photographs of pollen samples taken from three specimens of *E. nycteris*, forwarded specimens collected by the Programa Cooperativo sobre la Apifauna Mexicana (PCAM), and provided locality data from two specimens he identified at the Illinois Natural History Survey. Charles D. Michener also provided local-

ity data from specimens in the KU Collection. Joan W. Nowicke verified that the pollen samples taken by Dr. Yanega were most likely from three different plant families. Elaine R.S. Hodges was responsible for the excellent illustrations, and Maureen J. Mello assisted with SEM and GIS work and processed the return of borrowed specimens. Ricardo Ayala helped clarify various locality data. The manuscript was greatly improved by review comments from Robert W. Brooks, George W. Byers and C.D. Michener.

I would like to thank the following institutions and curators who arranged for loans of specimens, especially Janine Casevitz-Weulersse who processed the loan of type material from the Paris Museum.

CAS	California Academy of Sciences, San Francisco (W.J. Pulawski)
CU	Cornell University, Ithaca, New York (B.N. Danforth, M.S. Engel, G.C. Eickwort)
INHS	Illinois Natural History Survey, Urbana (W.E. LaBerge, D.A. Yanega)
LACM	Los Angeles County Museum of Natural History, California (R.R. Snelling)
KU	University of Kansas, Lawrence (B.A. Alexander, R.W. Brooks, C.D. Michener)
PARIS	Muséum National d'Histoire Naturelle, Paris (J. Casevitz-Weulersse)
PCAM	Programa Cooperativo sobre la Apifauna Mexicana (specimens loaned by D. Yanega)
UCB	University of California, Berkeley (H. V. Daly)
UNAM	Universidad Nacional Autónoma de México, Mexico City (H. Brailovsky)
UNAMC	Estacion de Biología Chamela, Universidad Nacional Autónoma de México (R. Ayala)
USU	Utah State University, Logan (T.L. Griswold)

¹ Department of Entomology, MRC-188, National Museum of Natural History, Smithsonian Institution, Washington, DC 20560.
E-mail: mcginley.ron@nsmnh.si.edu

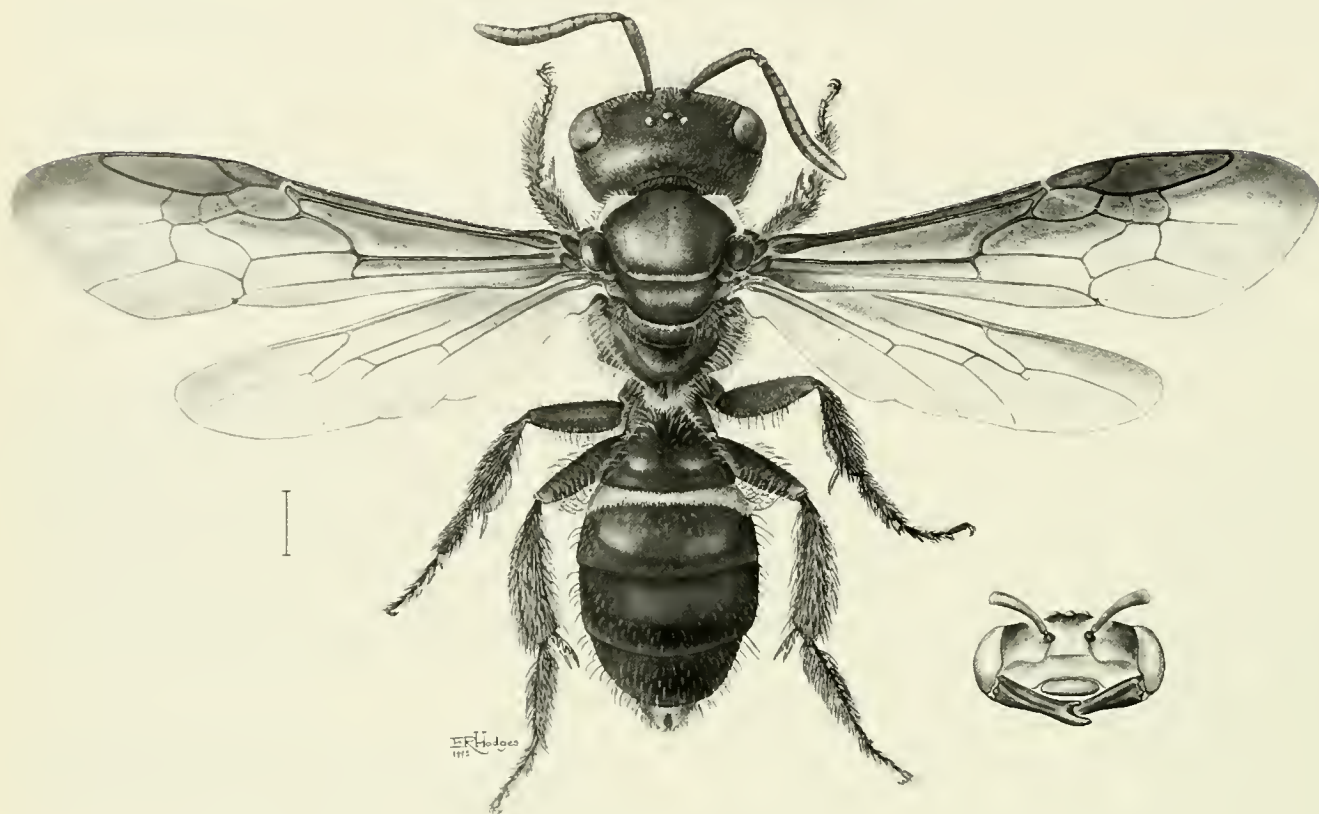

Fig. 1. *Eickwortia nycteris*, female; insert showing detail of bidentate mandible. Scale = 1mm

Eickwortia, new genus

As recognized herein, *Eickwortia* includes two rarely collected species: *E. nycteris* (Vachal) (Fig. 1), known only from 60 females and 8 males, ranging from Nayarit and San Luis Potosí, south to Nicaragua (Fig. 2); and *E. alexanderi*, new species, known only from one female from Costa Rica. Both species have been collected only at high elevations (*E. nycteris*: 823–2200 m; *E. alexanderi*: 1510 m).

Diagnosis.—*Eickwortia* females can be differentiated from other Halictidae by the *Dialictus*/*Evylaeus*-type forewing venation, i.e., second transverse cubital vein weaker than the first cubital vein (more like the third cubital vein; see McGinley, 1986, Fig. 80), combined with the strongly bidentate mandibles of the females (Figs. 6, 12). The mandibles of *Dialictus* and *Evylaeus* females have small subapical teeth. Also helpful in diagnosis are the darkly infuscated forewings (anterior third infuscated in both sexes of *E. nycteris*; entirely infuscated in the female of *E. alexanderi*). Only the male of *E. nycteris* is currently known (see following species diagnosis). Both sexes key out to *Lasioglossum* (sensu lato) in Michener et al. (1994); females run to *Evylaeus* in their subgeneric key.

Eickwortia nycteris (Vachal), new combination

FIGURES 1–11, 15, 16

Halictus nycteris Vachal, 1904:119 [female syntype series]; Moure and Hurd, 1987:308 [lectotype designation, taxonomic status].

Type Material.—The lectotype female specimen collected in 1862 is in good condition, missing only its right hind leg. It is pinned on a rectangular piece of white paper and is labeled: "Museum Paris [,] Mexique Orizaba [,] Biart 1862/[circular green piece of paper, folded in half]/TYPE [red label]/nycteris ♀ Vach [handwritten, presumably by Vachal]/Halictus nycteris Vach." [in different handwriting]. Moure (Moure and Hurd, 1987) indicated that he labeled one female of the syntype series "... as the lectoholotype" in March, 1958. This label is no longer associated with the specimen and I have attached the following label: "LECTOTYPE [,] Halictus nycteris Vachal, des.[ignated by] Moure & Hurd, 1987." The four known paralectotypes have been labeled: "PARALECTOTYPE [,] Halictus nycteris Vachal [,] des.[ignated by] Moure & Hurd, 1987" [red label]. Vachal's original description indicated he examined eight females. In 1975, Eickwort examined only the lectotype and four paralectotypes which I have



Fig. 2. Distribution of *Eickwortia* (dots = *E. nycteris*, circled dot = *E. alexanderi*).

also seen. The whereabouts of the three other type specimens is unknown to me.

Etymology.—The generic name, *Eickwortia*, in honor of the late George C. Eickwort, a premier student of bees and outstanding educator. Vachal's specific epithet, *nycteris*, is apparently derived from the Greek, *nyktos* = "night," or *nykteris* = "bat," presumably a reference to the dark coloration and infuscated forewings of this species.

Diagnosis.—Both sexes of *E. nycteris* superficially resemble *Neocorynura* (Augochlorini) due to the basal constriction of tergum I. However, they have the diagnostic features of Halictini, i.e., females lack a median cleft on tergum V, and males have the hind basitarsus broadly articulated with the second tarsomere. The conspicuously infuscated anterior third of the forewing surface, strongly bidentate mandibles, basally constricted tergum I, combined with the forewing venation characteristic of *Dialictus* and *Evylaeus*, i.e., second transverse cubital vein weaker than first (more like third) differentiate females of *Eickwortia nycteris* from all other known New World halictids. Males can be recognized by their highly constricted abdomen, infuscated wings, and in particular, their elongate and conspicuously slender legs.

Description.—(follows format of McGinley, 1986)

Female: (1) Length approximately 6.0–11.0 mm; (2) wing length 6.78–9.41 mm; (3) abdominal width 2.18–3.14 mm. [Measurements were taken from what appeared to be the smallest and largest specimens; only ranges are given because of the great size variation in this species.]

Structure. (4) Head broad, slightly wider than long (Fig. 5); length/width ratio, $\bar{x} = 0.91$, $n = 3$. (5) Gena, at midpoint, slightly wider than eye width (eye/genal ratio = 0.89) to much wider than eye in large-headed forms (eye/genal ratio = 0.61), [see Nesting Biology section, below, for discussion of "large-headed" terminology]; (6) gena rounded posteriorly to angulate in large-headed forms. (7) Supraclypeal area evenly rounded, (8) weakly protuberant. (9) Clypeus much broader than long, width/length ratio = 3.0–3.75; clypeus projecting approximately 0.75 its length below lower margin of eyes; (10) surface weakly convex to flat in large-headed forms, shallowly depressed apically; (11) clypeal surface usually with shallow median longitudinal sulcation, best developed in large-headed forms. (12) Frontal carina present, extending at least to midpoint between antennae and median ocellus. (13) Distance between lateral ocellus and eye less than distance between lateral ocellus and hind margin of vertex, especially so in large-headed forms (ocular-ocellar space approximately 3.5–3.8 lateral ocellar diameter); (14) distance between lateral ocellus and eye greatly exceeding distance between lateral ocelli (ratio = 1.5–2.0 in large-headed forms); (15) lateral ocelli joined above by weak impressed line. (16) Compound eyes slightly converging below, to parallel in large-headed forms. (17) Hypostomal carina extremely well developed; (18) anterior angle broadly rounded, (20) anterior carina nearly perpendicular to longitudinal carina. (21) Scape not quite reaching top of vertex; (22) pedicel longer than wide, slightly shorter than flagellomere 1; (23) flagellomere 1 subequal in length to flagellomere 2. (24) Labrum with basal area and distal process; (25) basal elevation well developed (unlike *Lasioglossum* sensu stricto, elevation is broader than long); (26) basal lateral depressions absent; (27) distal keel extremely narrow, becoming slightly broader apically as seen in frontal view (unlike *Lasioglossum* sensu stricto, keel is vertically constricted near basal third, appearing bilobed in lateral view); (28) distal lateral projections absent; (29) fimbrial setae acutely pointed. (30) Mouthparts not unusually modified or elongate; (31) mandible strongly bidentate (Fig. 6). (32) Pronotal lateral angle forming sharply pointed, projecting right angle; (33) pronotal lateral ridge complete; (34) lower portion of lateral ridge sharply edged; (34a) pronotal lobe narrowly rounded and projecting, conspicuously pointed and projecting in large-headed forms. (35) Mesoscutal anterior edge weakly bilobed, (36) strongly elevated from pronotum; (37) median mesoscutal line moderately well impressed to about half length of mesoscutum; (38) parapsidal lines approximately 0.30 the length of mesoscutum. (39) Median scutellar impression virtually absent. (40) Dorsal surface of propodeum about 0.75 the length of scutellum and approximately 1.4 times the length of metanotum, (41) weakly depressed centrally, (42) pos-

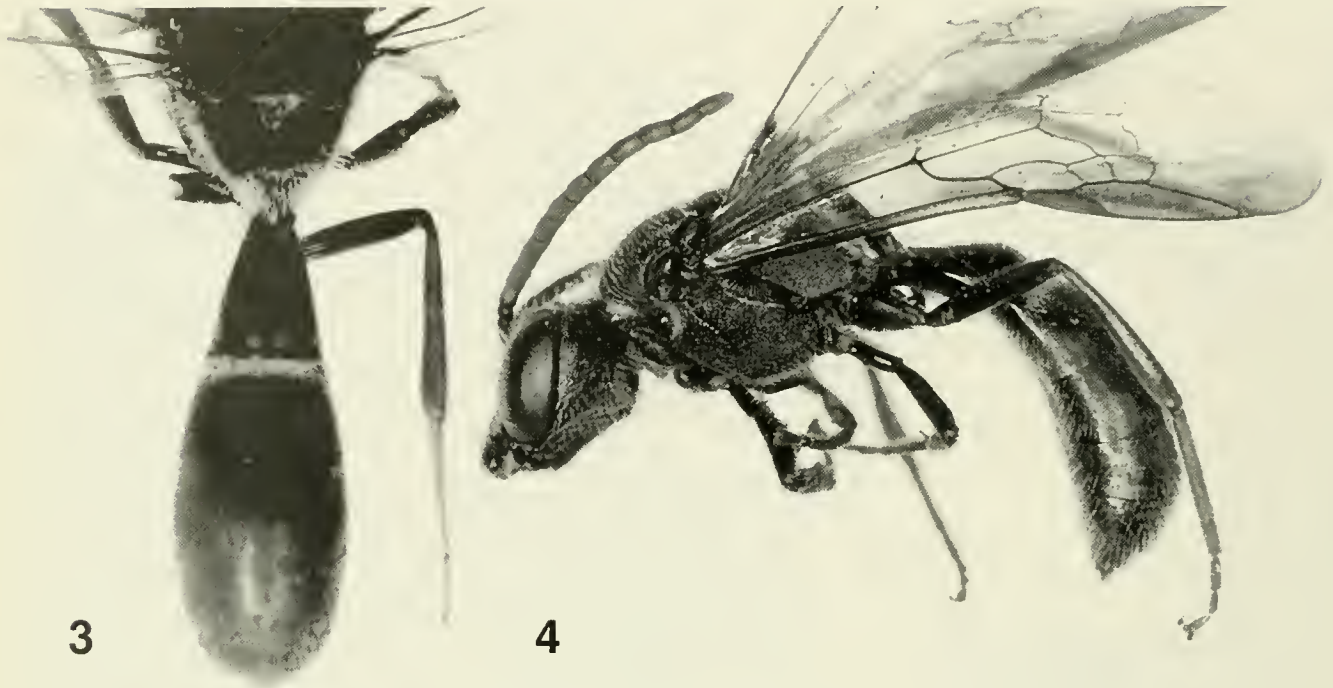

Figs. 3-4. *Eickwortia nycteris*, male. 3-Abdomen, dorsal view. 4-Lateral view.

terior margin rounded; (43) propodeal triangle weakly developed, median V-shaped area absent, lateral rims of propodeal dorsal surface absent; (44) lateral propodeal carinae weakly developed, extending no more than one-third height of posterior surface. (45) Inner hind tibial spur strongly pectinate, with four to five teeth (Fig. 8). (46) Lateral edge of metasomal tergum II straight.

Sculpture. (47) Face somewhat shiny, (48) area between ocelli and antennae finely granulate with conspicuous punctures throughout, punctures nearly contiguous above, becoming less dense near antennae where punctures are separated by 2-3 times their diameters. (49) Vertex near eye and (50) behind ocelli granulate with fine punctures separated by 1-2 times their diameters. (51) Supraclypeal area dull, densely granulate with obscure widely spaced punctures. (53) Clypeus granulate with widely spaced punctures separated by 3-5 times their diameters, apical quarter of clypeus usually less granulate, somewhat polished. (55) Hypostoma finely striolate. (56) Mesoscutum somewhat dull; (57) surface granulate throughout and doubly-punctate: fine punctures separated by 1-2 times their diameters, and larger, conspicuous widely scattered punctures separated by 5-10 times their diameters. (58) Scutellum and (59) metanotum granulate with widely scattered punctures. (60) Pre-episternum roughly striate; (61) hypoepimeral area finely striate, mesepisternum strongly striate, nonpunctate; (62) metepisternum strongly striate. (63, 64) Dorsal surface of

propodeum dull, microscopically granulate, usually finely striolate (Figs. 1, 7; I examined one specimen from Michoacan that had surface nearly smooth, with striae confined to anterior edge of propodeum). (65) Metasomal tergum I constricted basally (Fig. 1) with distinct biconvexities apically (terga II-III also with less conspicuous convexities); (66) surface granulate throughout with fine widely spaced punctures.

Coloration. (67) Head, thorax black, abdomen black with dark brown tones. (68) Clypeus without maculation. (69) Flagellum black dorsally, brown ventrally. (70) Tegula dark brown. (71) Wing membrane strongly infuscated on anterior one-third of surface (Fig. 1); veins and stigma brown. (72) Legs brown.

Vestiture. (73) Pubescence of head between vertex and antennae weakly plumose; (74) hairs yellowish brown. (75) Pubescence of thorax white to yellowish white; (76) mesocutal hairs sparse, widely spaced. (77) Hind tibial hairs dark brown to black dorsally, nearly white ventrally. (78) Anterior hairs of metasomal tergum I and (79) basal hair band of tergum II white. (80) Acarinarium (glabrous area surrounded by elongate hair fringe) on anterior surface of tergum I absent. (81) Basal hair bands on terga III-IV usually absent (hair band on tergum III weakly developed in 5 specimens, and strongly developed in one specimen from Guerrero).

Male: As described for female except: (1) Length 8.5-

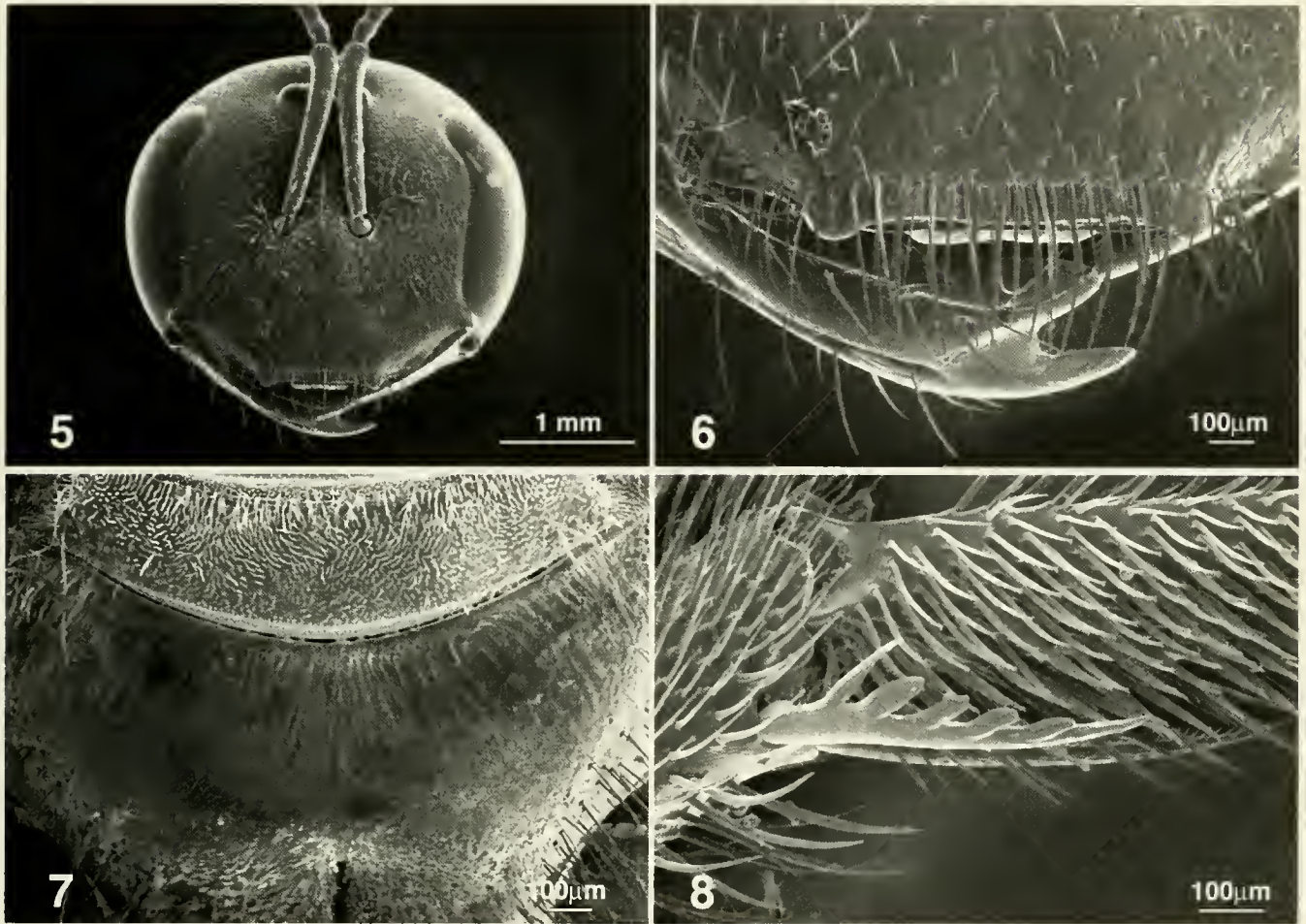

Figs. 5–8. *Eickwortia nycteris*, female. 5–Head. 6–Mandible. 7–Propodeum, dorsal view. 8–Inner hind tibial spur.

10.0 mm (\bar{x} = 9.0, n = 5); (2) wing length 2.2–2.6 mm (\bar{x} = 2.5, n = 5); (3) abdominal width 1.6–1.8 mm (\bar{x} = 1.7, n = 5).

Structure. (4) Head length and width subequal, or nearly so; length/width ratio, \bar{x} = 0.96–1.0, n = 3. (5) Gena, at midpoint, subequal in length to eye, (6) rounded posteriorly. (9) Clypeus approximately twice as wide as long, projecting approximately 0.75 its length below lower margin of eyes; (10) surface broadly rounded and somewhat protruding (unlike broad, flat clypeus of female); (11) clypeal surface without shallow median longitudinal sulcation. (13) Distance between lateral ocellus and eye subequal to distance between lateral ocellus and hind margin of vertex; (14) distance between lateral ocellus and eye only slightly exceeding distance between lateral ocelli (ratio = approximately 1.3); (16) Compound eyes converging below. (17) Hypostomal carina well developed (less so than in females); (18) anterior angle very narrowly rounded, (20) anterior carina forming acute angle with longitudinal carina. (21) Scape short, extending to midpoint

between antennal base and median ocellus; (22) pedicel wider than long, half length of flagellomere 1; (23) flagellomere 1 half as long as flagellomere 2. (24) Labrum without basal area and distal process; (25) basal elevation absent; (27) distal keel absent. (31) Mandible very short, barely reaching opposing clypeal angle, simple, subapical tooth absent. (32) Pronotal lateral angle well developed but not as sharply acute as in females; (34a) pronotal lobe narrowly rounded but not projecting or conspicuously pointed as in females. (45) Inner hind tibial spur weakly serrate, not pectinate. (46) Lateral edge of metasomal tergum II weakly concave.

Sculpture. (48) Area between ocelli and antennae densely punctate throughout, punctures contiguous. (49) Vertex near eye and (50) behind ocelli irregularly striolate, nonpunctate. (51) Supraclypeal area dull, densely granulate, nonpunctate. (53) Clypeus weakly granulate, somewhat shiny, with widely spaced punctures separated by 2–3 times their diameters. (55) Hypostoma weakly striolate. (56) Mesoscutum, (58) scutellum and (59) metanotum

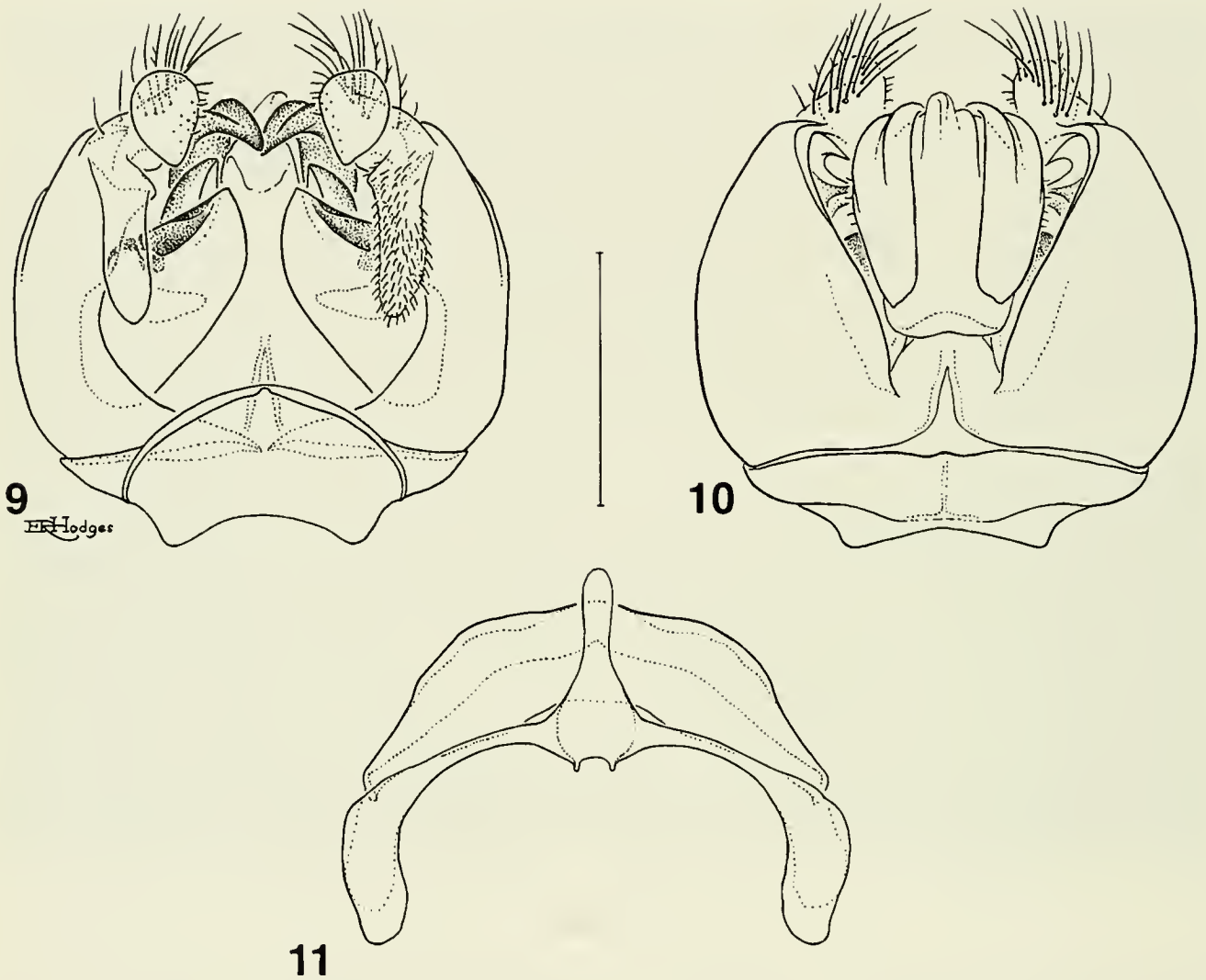

Figs. 9-11. *Eickwortia nycteris*, male terminalia. 9-Genitalia, ventral view. 10-Genitalia, dorsal view. 11-Sterna VII-VIII, ventral view. Scale = 1mm.

somewhat dull, surface densely and roughly granulate throughout, with minute nearly contiguous punctures. (60) Pre-episternum and (61) hypoepimeral area ruguloso-striolate; (62) metepisternum more distinctly striolate. (65) Metasomal tergum I constricted basally, with inconspicuous biconvexities apically (much weaker than those of females).

Coloration. (67) Head and thorax black, abdomen black dorsally, sterna, lateral edges of terga and basal quarter of tergum I orange-brown. (68) Apical half of clypeus with broad yellow maculation. (69) Flagellum black dorsally, orange-brown ventrally. (70) Tegula brown to yellowish brown. (71) Wing membrane strongly infuscated on anterior one-third of surface (similar to female, Fig. 1);

veins and stigma brown. (72) Femur dark brown to black with distal quarter orange-brown; tibiae light brown to black dorsally, orange-brown ventrally; tarsi light brown to orange-brown.

Vestiture. (81) Basal hair bands on terga III-IV present or absent (present in approximately half the specimens examined). (82) Sternum IV with short, adpressed hairs on apical edge; (83) sternum V with moderately elongate fringe of hairs on apical edge (not forming a distinct pattern).

Terminalia. Sterna VII-VIII as in Fig. 11; (84) Sternum VII with elongate, slender median process, lateral lobes broad; (85) sternum VIII broad, without median process. Genitalia as in Figs. 9, 10; (86) gonobase short; (87)

gonostylus moderately elongate, rounded apically; (88) retrorse membranous lobe present, moderately short, slender, narrowly rounded apically; (90) volsella with prominent lateral lobe.

Specimens Examined.—68 (60 females, 8 males).

EL SALVADOR. Mt. San Salvador, 8 Jul 1963, M.E. Irwin, D.Q. Cavagnaro (1 female; UCB).

GUATEMALA. Escuintla, 6.3 mi NE [13°42'N, 89°12'W], 1 Aug 1966, Univ. Kans. Mex. Expedition (1 male; KU). Finca San Rafael, Sacatpequez, 6900 ft [14°20'N, 90°31'W], 11 Jun 1948, sweeping path in woods, CNHM Guatemala Expedition (1948), R.F. Mitchell (1 female; INHS). Zacapa, 3.5 km S.E. La Union, 1500 m [14°58'N, 89°32'W], 23 June 1993, R. Brooks, J. Ashe #084 (1 female; KU).

MEXICO. **Chiapas:** Lomata, 5 Mar 1953, R.C. Bechtel, E.I. Schlinger, *Halictus nycteris* Vach, homotype 1975, det. G.C. Eickwort (1 female; UCB). Sibakte 'el, Tenejapa, 5500 ft, 6–8 Aug 1966 [16°49'N, 92°31'W], D.E. Breedlove, J. Emmel (1 female; CAS). Municipio Zinacantán, Parajé Navenchauk, 2194 m, 3 Aug 1976, D.E. & J.A. Breedlove (1 female; CAS). Municipio Zinacantán, Parajé Vobits, 1371 m, 18 Aug 1976, D.E. & J.A. Breedlove (1 female; CAS). **Guerrero:** Taxco, 7 km E, 1560 m, 29 Oct 1991 [18°33'N, 99°36'W], [ex] *Difourea* along small dirt path, big patch fl along rd, R. Ayala (1 female; UNAMC). **Hidalgo:** Chapulhuacán [21°10'N, 98°54'W], 19 Jun 1941, H.S. Dybas (1 female; INHS). Chapulhuacán, 2.4 mi S (Hwy. 85), 2700 ft, 12 Jul 1973, R.R. Snelling, T.W. Taylor (4 females; LACM). Jacala, 8 mi S (La Placita, Hwy. 85), 5400 ft, 13 July 1973, *Ipomoea*, R.R. Snelling, T.W. Taylor (2 females; LACM). Jacala, 10.6 km N, Hwy 85 (km 192) [21°01'N, 99°11'W], 1620 m, 11 Jul 1990, R.L. Minckley (1 female; KU). Jacala, 38 mi NE, 3100 ft, 10 Jul 1961, Univ. Kans. Mex. Expedition. Jacala, 32 mi NE, 3950 ft, 10 Jul 1961, on flowers of *Bidens*, Univ. Kans. Mex. Expedition, (6 females, 2 males; KU). Otongo, 10 km E, 1110 m [20°59'N, 98°42'W], 10 Nov 1991, manganese mine area, composites along rd, R. Ayala, C. Everaert (1 female, 1 male; UNAM). Tenango de Doria, Cerro El Cirio [20°19'24"N, 98°11'52"W], 26 Mar 1994, 13:00 hrs, L. Godínez, LG-980 (1 female; UNAM). Tenango de Doria, La Colonia, 8 Sep 1993, 14:15 hrs, L. Godínez, LG-818 (1 female; UNAM). Tenango de Doria, El Damó [20°19'30"N, 98°13'38"W], 3 Nov 1993, 10:00 hrs, L. Godínez, LG-761 (1 male; UNAM). Tenango de Doria, El Texmé, 1250 m, 18 Apr 1994, 15:30 hrs, J.L. Salinas, JL-106 (1 male; UNAM). Tenango de Doria, El Texmé, 1250 m, 10 Aug 1993, 15:30 hrs, L. Godínez, no. 834 (1 female; UNAM). Tenango de Doria, Camino a El Texmé, 1250 m, 8 Oct 1993, 11:45, 14:20, 15:50 hrs, L. Godínez, LG-828, 833, 835 (3 females; UNAM). S of Tamazunchale, Hwy 85 (km 239) [21°16'N, 98°47'W], 1050 m, 10 Jul 1990, I. Yarom (1 female;

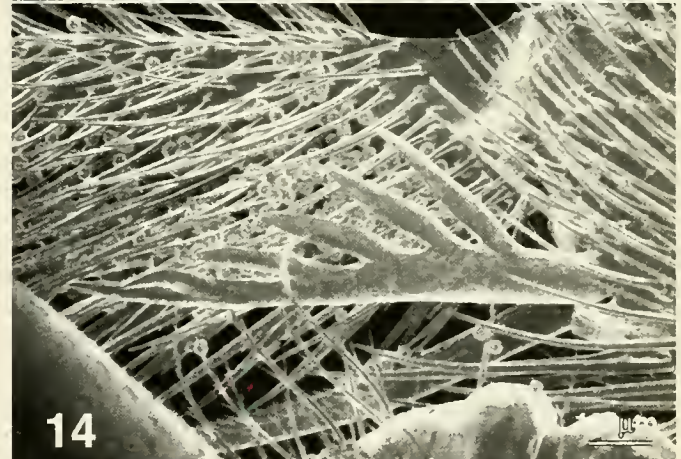
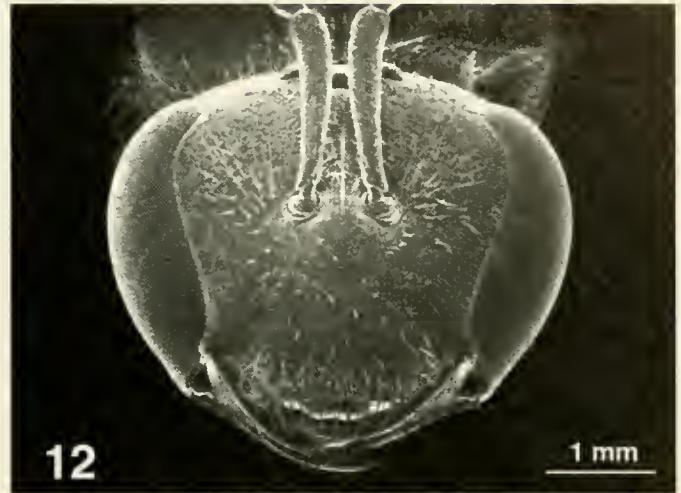

Figs. 12–14. *Eickwortia alexanderi*, female. 12—Head. 13—Propodeum, dorsal view. 14—Inner hind tibial spur.

KU). Tlanchinol [20°59'04"N, 98°38'13"W], 1600 m, 13 Sep 1993, 16:15 hrs, L. Godínez, LG-896 (1 female; UNAM). Tlanchinol, [20°59'04"N, 98°38'13"W], 1600 m, 30 Apr 1994, 11:30 hrs, L. Godínez, LG-1002 (1 male; UNAM). Xochicoatlán [20°48'N, 98°40'W], 18 Mar 1979, en madera de *Pinus*, M.A. Morón (1 female; UNAM: Mexico City). 19.5 km S San Luis Potosí-Hidalgo border on Hwy 85, 1200 m, 11 Jul 1990, D. Conlon, R.L. Minckley (2 females; KU).

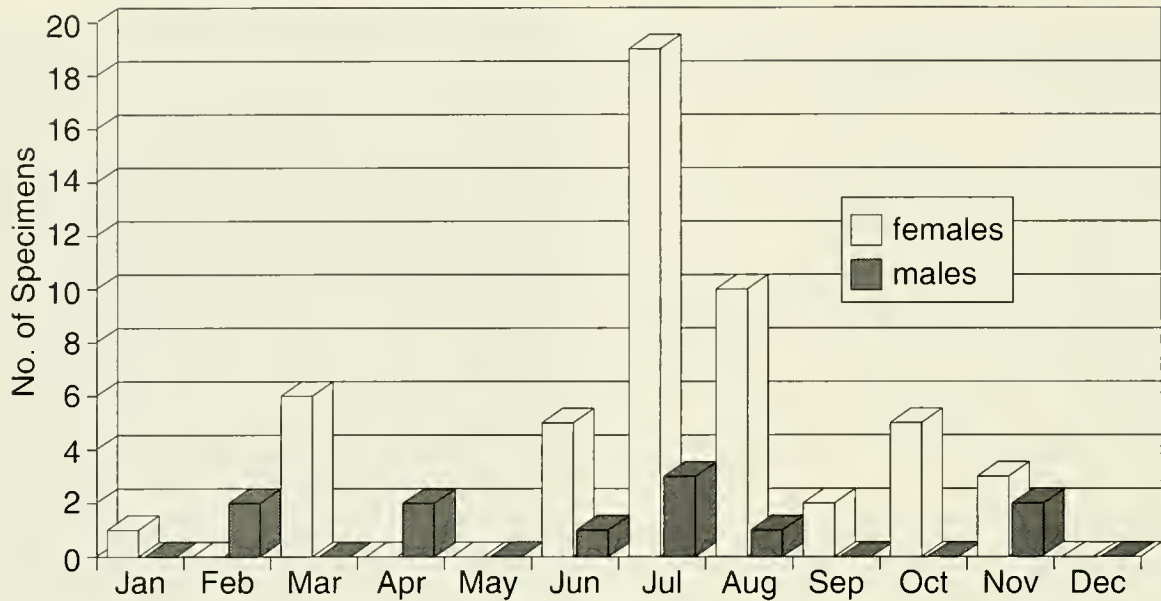

Fig. 15. *Eickwortia nycteris*, flight records.

Hwy 85 (km 232), 1200 m, 11 Jul 1990, I. Yarom (2 females; KU; one used for habitus illustration by E. Hodges, and is so labeled). **Mexico:** Chalma [18°55'N, 99°26'W], 1700 m, 26 Nov 1990, L. Godínez, no. 629 (1 female; PCAM). Chalma [18°55'N, 99°26'W], 1700 m, 26 Nov 1990, on *Simsia amplexicaulis*, L. Godínez, no. 625 (1 female; PCAM). Ixtapan de la Sal, 9 mi N [labeled as from Guerrero], [18°50'N, 99°41'W], 16 Aug 1981, J. Chemsak, A&M Michelbacher (1 female; UCB). **Michoacán:** Patzcuaro, 8 km S [19°31'N, 100°36'W], 2200 m, 27 Oct 1987, L. Godínez, LG-205 (1 female; KU). **Nayarit:** Santa Isabella [Santa Isabel?, 21°10'N, 104°37'W], 9 mi NW, 10 Mar 1972, F. Parker, D. Miller, Utah State Univ. Intermountain Insect Survey (3 females; USU). **Oaxaca:** Guelatao [17°18'N, 96°29'W], 20 Feb 1991, on *Bidens pilosa*, L. Godínez, no. 663 (2 males; UNAM). **Puebla:** Cuetzalán, 3 mi SW (N of Zacapoaxtla) [20°02'N, 97°31'W], 4100 ft, 19 Jun 1961, Univ. Kans. Mex. Expedition (2 females; KU). Huauchinango, 8 mi E [20°11'N, 98°03'W], 4050 ft, 21 Aug 1962, Univ. Kans. Mex. Expedition (1 female; KU). Teziutlán, 5 m NE [19°49'N, 97°21'W], 4700 ft, 27 Jun 1953, Univ. Kans. Mex. Expedition (1 female; KU). Teziutlán, 5 m NE, 1700 ft, 27 Jun 1953, Univ. Kans. Mex. Expedition (1 male; KU). Teziutlán, 8.5 mi NE, 4800 ft, 13 Aug 1969, Univ. Kans. Mex. Expedition [1 female; KU]. **Queretaro:** Jalpán, 43 km E [21°14'N, 99°29'W], 1100 m, 17 Aug 1987, on Compositae, D. Yanega, (1 female; KU). Jalpán, 43 km E, 1500 m, 24 Aug 1988, *Bidens*, D. Yanega (1 female; KU). **San Luis Potosí:** Platanito, 141 km W, 900 m, 27 Jul 1990, W. Bell, I. Yarom (1 female; KU). **Veracruz:** Coscomatepec, Río Jamapa NE of Coscomatepec [19°04'N, 97°02'W], 4300 ft,

8 Aug 1969, Univ. Kans. Mex. Expedition [1 female; KU]. Jalapa, 2 mi NW, 17 Aug 1959, L.A. Stange, A.S. Menke (1 female; LACM). Las Vigas, 12 km SE [19°36'N, 97°08'W], 2070 m, 14–15 Jul 1974, J.A. Chemsak, E. & J. Linsley, J. Powell (1 female; UCB). Orizaba [18°51'N, 97°06'W], 1862, Biart [one female lectotype, four female paralectotypes; PARIS]. Xico, Texolo Falls [19°25'N, 97°00'W], 11 Jan 1982, in ground [incorrectly labeled as being "in ground," R. Brooks pers. comm.], B.H. Smith [1 female; KU].

NICARAGUA. Santa Maria de Ostuma [13°00'N, 86°00'W], Nov 1959, N.L.H. Krauss (1 female; CU).

Eickwortia alexanderi, new species

FIGURES 12–14

Type Material.—The female holotype of *E. alexanderi* is deposited in the Snow Entomological Collection (University of Kansas). It is labeled: "Costa Rica, Heredia [,] 8.7 km N. Varablanca [10°00'N, 84°07'W], 1510 m, July 18, 1964 [,] M.G. Naumann coll. HOLOTYPE [,] *Eickwortia alexanderi* [,] R.J. McGinley" [red label]. The head has been glued to the thorax but the specimen is otherwise in excellent condition.

Etymology.—This species is named in honor of the late Byron A. Alexander, a valued colleague and former student of George Eickwort's, whose brilliant young career was tragically cut short in 1996.

Description.—*Female:* as described for *E. nycteris* except for the following: (1) Length approximately 9.0 mm; (2) wing length 7.26 mm; (3) abdominal width 2.84 mm.

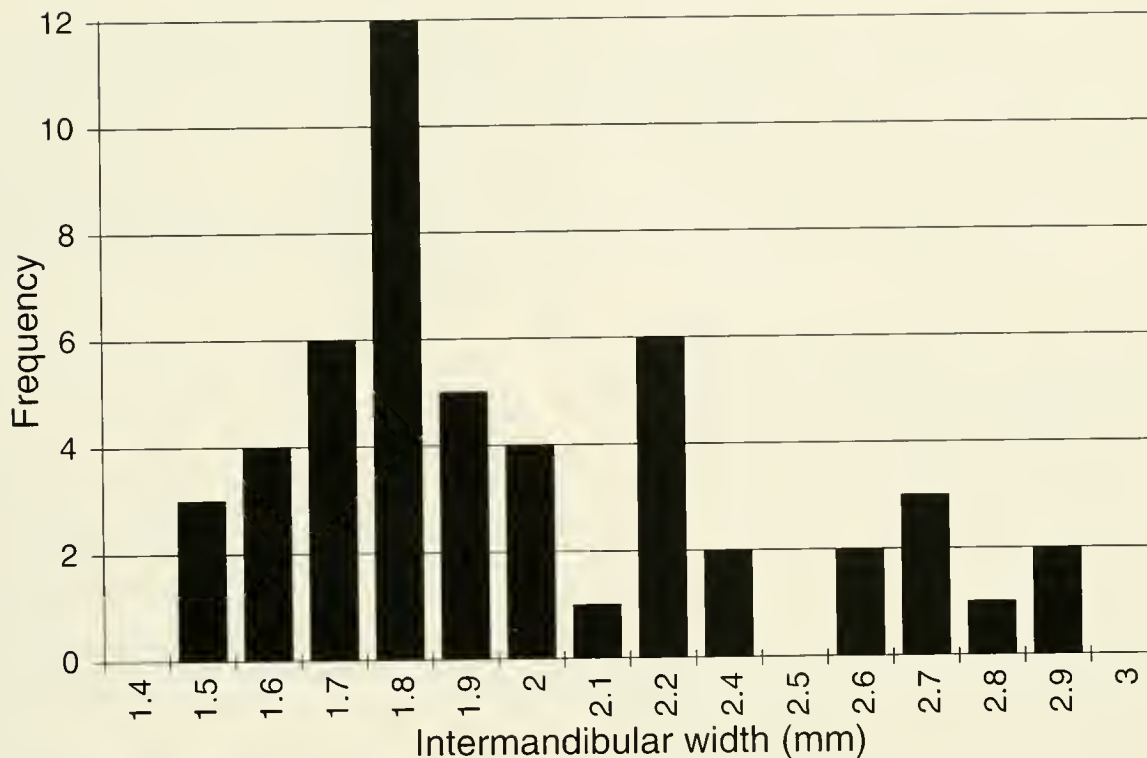

Fig. 16. Histogram showing size variation in intermandibular widths for 51 females of *E. nycteris*.

Structure. (4) Head broad (Fig. 12), not appearing rounded due to compound eyes converging ventrally; length/width ratio = 0.90. (5) Gena, at midpoint, wider than eye width (eye/genal ratio = 0.64), (6) rounded posteriorly. (9) Clypeus broader than long, width/length ratio = 2.75 (not as broad as in *E. nycteris*); (10) surface weakly convex, not depressed apically; (11) clypeal surface without shallow median longitudinal sulcation. (13) Distance between lateral ocellus and eye slightly greater than distance between lateral ocellus and hind margin of vertex (ocular-ocellar space approximately 2.3 times lateral ocellar diameter); (14) distance between lateral ocellus and eye exceeding distance between lateral ocelli (ratio = 1.5). (16) Compound eyes converging below. (24–29) Labral characters were not examined because only one specimen, the holotype, is currently known. (31) Mandibles strongly bidentate as in *E. nycteris* (Fig. 12). (33) Pronotal lateral ridge incomplete, weakly developed; (34) lower portion of lateral ridge rounded, indistinct; (34a) pronotal lobe narrowly rounded and projecting but not as conspicuous as in *E. nycteris*. (35) Mesoscutal anterior edge rounded, not bilobed; (37) median mesocutal line weakly impressed. (41) Dorsal surface of propodeum depressed centrally (Fig. 13), lateral rims of propodeal dorsal surface well developed with conspicuously elevated, narrowly rounded edges; (44) lateral propodeal carinae moderately developed, extending one-half distance of posterior surface. (45)

Inner hind tibial spur similar to that of *E. nycteris* (Fig. 14). (46) Lateral edge of metasomal tergum II very weakly concave.

Sculpture. (48) Punctures in area between ocelli and antennae separated by 2–3 diameter widths. (49) Vertex near eye and (50) behind ocelli sculptured as between ocelli and antennae. (51) Supraclypeal area somewhat shiny, granulate. (53) Clypeus finely alveolated, apical quarter of clypeus not distinctly different from basal area. (56) Mesoscutum somewhat shiny; (57) surface smoothly alveolated throughout, simply punctate (not doubly-punctate as in *E. nycteris*), punctures separated by 1–5 times their diameters. (58) Scutellum sculptured as mesoscutum but punctures more dense medially; (59) metanotum densely punctate with small nearly contiguous punctures. (60) Pre-episternum, (61) hypoepimeral area, mesepisternum, and (62) metepisternum all distinctly striate (not as conspicuous as in *E. nycteris*). (63, 64) Dorsal surface of propodeum somewhat shiny, not granulate, distinctly and regularly striolate to posterior rim (Fig. 13). (65) Metasomal tergum I normal (not narrowed basally, without apical biconvexities); (66) surface microscopically striolate throughout with extremely fine widely spaced punctures.

Coloration. (71) Membrane of forewing entirely infuscated.

Vestiture. (75) Pubescence of thorax dark brown except for white hair patch on edge of pronotal lobe and surrounding area of pre-episternum. (77) Hind tibial hairs all dark brown. (78) Anterior hairs of metasomal tergum I dark brown, very sparse; (79) basal hair band of tergum II absent. (81) Basal hair bands absent from terga III–IV.

DISCUSSION

FLIGHT DATA

Females of *E. nycteris* appear to be active throughout the year and have been collected from January through November (Fig. 15). The peak collections in July may simply reflect when bee specialists are most active in the field. Detailed studies of individual populations are needed to determine seasonal patterns. Males of *E. nycteris* have been collected from February to November. The one known specimen of *E. alexanderi* was collected in July.

FLORAL ASSOCIATIONS

Unfortunately, only 12 (20%) of the 60 known females of *E. nycteris* are associated with floral data. Nine of these are records from Asteraceae. Seven of these specimens (five with pollen in their scopa) were taken from *Bidens* (Asteraceae) and one from *Simsia amplexicaulis* (Asteraceae). Two females with pollen were recorded from "Compositae." Douglas Yanega provided SEM photographs of pollen taken from three specimens of *E. nycteris*. As Dr. Yanega suggested (pers. comm., 1996), and was verified by Joan Nowicke (NMNH palynologist), one type of pollen is that of Asteraceae and the other two are most likely from two different plant families. While this would indicate *E. nycteris* is probably polylectic (a floral generalist), the known floral associations would suggest that flowers of Asteraceae would be a good place to look for additional specimens of *Eickwortia*.

NESTING BIOLOGY

The great range in female body size which appears to be correlated with head width, genal length, and posterior genal projection (a syndrome similar to that of the primitively eusocial *Halictus ligatus*), suggests that *E. nycteris* may be social to some degree. "Large-headed" females are often twice the size of most smaller females, as is reflected in the range of intermandibular distances measured for nearly all known specimens (Fig. 16). The nesting biology of this species should be considered a primary research target for bee specialists, especially for those interested in halictine social behavior.

Of additional biological interest are the strongly bidentate mandibles of females of both species of *Eickwortia*. Females of *Lasioglossum* (sensu lato) are (with few exceptions) ground-nesting bees that have mandibles with small, subapical teeth. The strongly bidentate mandibles of *Eickwortia* suggest these species possibly nest in wood. The first specimen of *E. nycteris* I examined was associated with the handwritten note "... en madera de Pinus" [specimen from Xochicoatlán, Hidalgo; UNAM collection].

FUTURE COLLECTING AND RESEARCH PRIORITIES

Suggestions for future work on *Eickwortia* include (in no particular order):

1) Collection of additional specimens of both species with emphasis on high altitude oak/pine forests (823 meters and above) and with a focus on Asteraceae as host plants (especially *Bidens*). Discovery of males of *E. alexanderi* would be an excellent find. With the intensive survey work being undertaken in Costa Rica, e.g., INBIO, it would be surprising not to see additional specimens of this species in the future.

2) Because the size variation among females of *E. nycteris* suggests this species may be social to some degree, knowledge of its nesting biology would be of great interest. The strongly bidentate mandibles of the females and limited biological data reviewed above would indicate that bee specialists should consider searching for nesting activity associated with wood.

3) The phylogenetic relationships of this genus to other halictines need to be explored, based on morphological and molecular data. Because *Eickwortia* appears related to New World *Evylaeus*, a large and taxonomically difficult group currently being revised (McGinley, in prep.), exploration of phylogenetic relationships based on morphological characters is deferred for an anticipated study of halictine higher classification.

LITERATURE CITED

- McGinley, R. J. 1986. Studies of Halictinae (Apoidea: Halictidae), I: Revision of New World *Lasioglossum* Curtis. *Smithsonian Contributions to Zoology* 439, vi + 294 pp.
- Michener, C. D., R. J. McGinley and B. N. Danforth. 1994. *The Bee Genera of North and Central America (Hymenoptera: Apoidea)*. Smithsonian Institution Press: Washington, D. C., viii + 209 pp.
- Moure, J. S. and P. D. Hurd, Jr. 1987. *An Annotated Catalog of the Halictid Bees of the Western Hemisphere (Hymenoptera: Halictidae)*. Smithsonian Institution Press: Washington, D. C., vii + 405 pp.
- Vachal, J. 1904. Etude sur les Halictus d'Amerique (Hym.). *Miscellanea Entomologica*, Narbonne 12: 113–128.

A New *Bittacus* from Southern Mexico (Mecoptera)¹

By

GEORGE W. BYERS²

ABSTRACT *Bittacus alexanderi*, n. sp., is described from southern Puebla and compared with similar regional species. Taxonomically useful characters of both sexes are illustrated.

Keywords: Hanging-flies; Scorpion-flies.

INTRODUCTION

Four species of *Bittacus* have already been described from Mexico: *B. mexicanus* Klug in central Mexico; *B. banksi* Esben-Petersen, widespread in Mexico and Central America; *B. sylvaticus* Byers in central Veracruz; and *B. peninsularis* Byers in southern Baja California. Others have been found but await description. The species described here was found, almost accidentally, when I was searching for the elusive *Eremobittacus* (Byers, 1997), near Petlalcingo, in southern Puebla.

ACKNOWLEDGMENTS

I thank Robert W. Brooks, who accompanied Byron Alexander during the study of bees in northern Mexico, and who described to me Byron's goals on that trip. Thanks also to Steve Ashe, Wes Bicha, and Don Webb for helpful comments on an earlier version of this paper, to A. R. Thornhill, who accompanied me on the 1972 trip to Mexico, and to Cynthia Woods and Sharon Lee Green for entering this paper into computer.

SYSTEMATICS

Bittacus alexanderi, new species

Description based on 10 males, 24 females, pinned.

Head.—Dorsum and frons unevenly sordid brown, ocellar prominence darker brown to almost black. Lateral ocelli nearly twice diameter of median ocellus; males (and a few females) with two short, black setae close behind median ocellus. Rostrum dark yellowish brown to reddish brown, clypeus glossy; maxillary palps dark brown except nearly bare terminal segment yellowish brown to brown; labial palps yellowish brown. Antennal scape and pedicel brown, flagellum light brown with 21–22 flagellomeres.

Thorax.—Pronotum brown, with two large, black setae at each side on anterior margin, each arising from widened, slightly raised prominence on margin; posterior margin with one seta at each side. Mesonotum and

metanotum unevenly brown; large black seta on prescutal prominence of mesonotum above and before base of fore wing, another on anepisternum anterior to and slightly lower than wing attachment; pair of small setae on mesonotal scutellum in some males. Pleural surfaces, coxae and mera unevenly sordid light brown, with sparse, yellowish setae, longest and most dense on coxae; single black seta on mesepimeron, one on anterior coxa (most specimens) and one on middle coxa, 3 or 4 on posterolateral surface of hind coxa. Femora, tibiae and tarsi dark yellowish brown, femora darkest; femoral setae sparse, long, black; shorter tibial and tarsal setae black; tibial spurs long and slender, spurs of hind tibia nearly as long as basitarsus. Hind femora enlarged in both sexes, about 1.5 times diameter of other femora.

Wing membrane strongly tinged with brown; pterostigma light brown, scarcely evident; veins light brown. Scv shortly before level of Frs, 2 Pcv, apical crossvein present but not close to end of 1A. Fore wing with 6–7 black setae along posterior margin near base; 3–7 such setae on hind wing.

Abdomen of male.—Terga unevenly yellowish brown to brown; tergum 2 with 6–9 large, black setae along each lateral margin. Sterna similarly colored, narrow, anterior ones usually drawn upward and concealed in lateral aspect by terga in dried specimens. Terga 3, 4 and 5 each nearly as long as 6 and 7 together. Segment 8 very short, tergum partly concealed dorsally by tergum 7. Posterior edges of sterna 7–9 thin. Epiandrial appendages of tergum 9 (Figs. 1, 2) elongate, generally parallel-sided, rounded at apex, with long bordering setae; spinose projection on mesal surface of dorsal margin and group of 5–6 thick, black spines directed mesad from ventral margin near base. Basistyles short, subrectangular in lateral aspect, with concentration of stiff setae on posterior surface. Dististyles small, blunt-tipped. Cerci (Fig. 1) longer than epiandrial appendages, of nearly uniform diameter throughout, with dorsal setae on apical half recurved. Aedeagus widened

¹ Contribution Number 1399 from the Snow Entomological Collection, Museum of Natural History, The University of Kansas.

² Snow Entomological Collection, Division of Entomology, Natural History Museum, University of Kansas, Lawrence, KS 66045.

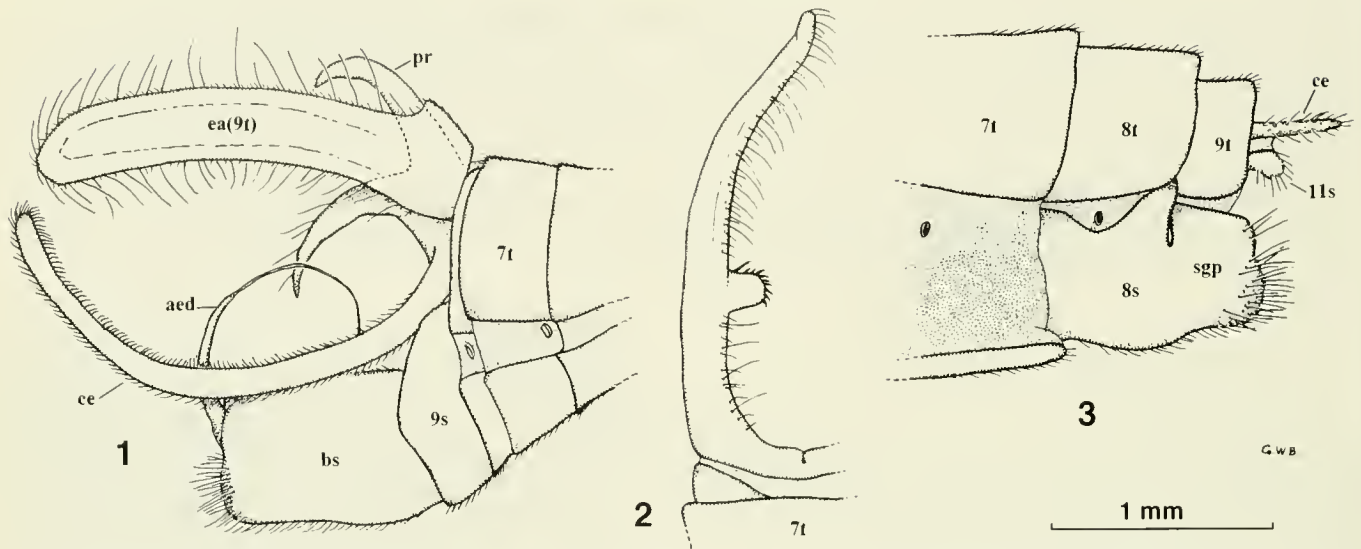

Figs. 1-3. *Bittacus alexanderi*, new species. 1—Terminal abdominal segments of male, right lateral aspect; aed—aeedeagus, bs—basistyle, ce—cercus, ea—epiandrial appendage (ninth abdominal tergum), pr—proctiger, s—sternum, t—tergum. 2—Right epiandrial appendage of male, dorsal aspect; 7t—abdominal tergum 7, concealing median portion of tergum 8. 3—Terminal abdominal segments of female, left lateral aspect; ce—cercus, s—sternum, sgp—subgenital plate, t—tergum. Scale: all figures.

near base, then reduced to thin, non-coiled, sclerotized filament. Proctiger two-branched, upper branch strongly sclerotized, arched dorsad, without setae; lower branch semi-membranous, with pale dorsal setae.

Abdomen of female.—Terga unevenly brown, darker toward posterior end except segments 8–11 again paler; 5–8 black setae along each lateral margin of second tergum. Sterna long, narrow, brown. Sternum 8 narrowly but completely divided along ventral mid-line, notched dorsally at each side around spiracle. Subgenital plates (Fig. 3) with numerous strong setae near posterior margin. In dried specimens, tenth segment recessed within ninth; cerci and parts of segment 11 protruding (Fig. 3). Eggs subcuboidal, with six impressed sides.

Measurements.—Body length, male, 19.3–21.8 mm. (holotype 20.0 mm.); female, 16.5–20.0 mm. (allotype 18.2 mm.). Fore wing, male, 22.0–24.0 mm. (holotype 23.2 mm.); female 22.0–23.6 mm. (allotype 23.5 mm.). Antenna (both sexes) 9.9–11.2 mm.

Types.—Holotype, male, allotype and 4 male, 14 female paratypes collected 3 miles (4.8 km.) northwest of Petlalcingo, Puebla, Mexico, on 29 August 1972, by G.W. Byers and R. Thornhill (GWB field catalogue: Puebla no. 33); 2 male, 5 female paratypes, same locality, 5 September 1972 (GWB cat.: Puebla no. 34); in the Snow Entomological Division, Natural History Museum, University of Kansas, Lawrence, Kansas 66045; 2 male, 3 female paratypes collected 3 miles north of Petlalcingo, 14 August 1993, and 1 male, 1 female at same locality, 15 August 1993, by Wes and Fred Bicha, in Wes Bicha collection. The type locality

is along a dry stream bed at a bridge on Highway 190, 4.8 km. northwest of the junction of the highway and a short side road leading into the village of Petlalcingo; elevation 1400 m. The bittacids were in the shade provided by low herbaceous plants a meter or less in height; they were not found beneath larger acacia-like trees. The habitat was surprisingly dry for bittacids, the ground bare, dry and stony between plants. This was also the habitat of the rare *Eremobittacus*, found by other collectors many years earlier. The Bicha collections were made in low growth "in the shade of fence row trees" (including acacias) at the edge of a corn field left dry and barren by mid-August. There was no stream anywhere nearby.

Discussion.—In its coloration and general appearance, *Bittacus alexanderi* resembles both *B. banksi* Esben-Petersen and *B. spatulatus* Byers (a species currently known only from Costa Rica and Nicaragua). Both these species have elongate cerci and long, approximately parallel-sided epiandrial appendages in the male. Males of *B. alexanderi* can be easily recognized, however, by the blunt, spinose projection from the inner dorsal margin of each epiandrial appendage.

Females of *B. alexanderi* can be recognized by the characteristic shape of the eighth abdominal sternum and attached subgenital plates. However, the exact outlines of these structures are not easily seen in females that have become somewhat deformed in the drying process.

This species is named in memory of Dr. Byron A. Alexander (1952–1996), with whom I enjoyed a close working relationship for several years. Byron was not just a col-

league in the Department of Entomology and in the Snow Entomological Museum. He was, in a sense, my replacement, holding a curatorial position in the Museum and teaching some of the courses that I had taught for many years. He was interested in Mexican insects, particularly bees, and had studied the plant associations of bees in Chihuahua, Coahuila and Sonora. He had been investi-

gating the resources used by bees of the genus *Diadasia* to learn whether plants chosen as nectar sources by these bees correlated with the supposed phylogeny within the genus.

LITERATURE CITED

- Byers, G. W. 1997. Four puzzling new species of Mecoptera. Proceedings of the Entomological Society of Washington 99: 681-692.

Resolving Conflict Between Morphological and Molecular Evidence for the Origin of Eusociality in the “Corbiculate” Bees (Hymenoptera: Apidae): A Hypothesis-Testing Approach

By

TED R. SCHULTZ^{1,2}, MICHAEL S. ENGEL³, AND MICHAEL PRENTICE⁴

ABSTRACT A hypothesis-testing approach is employed in an attempt to resolve conflicting evidence in two data sets, one morphological and one molecular, for the origin of eusociality in the “corbiculate” bee tribes Apini, Bombini, Euglossini, and Meliponini. After determining that both data sets contain high levels of character congruence (i.e., “phylogenetic signal”), four statistical tests are used to determine whether each data set is significantly able to distinguish between three pairs of alternative hypotheses. Based on the results of these tests, neither data set is able to distinguish between single (favored by the morphological data) vs. dual (favored by the rDNA data) origins for “general” eusociality, present in Bombini, Meliponini, and Apini. In contrast, the two data sets significantly favor opposite scenarios for single (morphology, >95% confidence) vs. dual (rDNA, >90% confidence) origins for “advanced” eusociality, present in Apini and Meliponini. When the morphological and rDNA data are combined into a single data set, the resulting tree favors a dual origin for general eusociality and a single origin for advanced eusociality; however, internal character conflict eliminates all power to significantly distinguish this result from alternative hypotheses.

We conclude that, despite strong conflict between the two data sets, there is no compelling evidence for rejecting Darwin’s (1859) logical “null” hypotheses of a single origin for general eusociality in the group (Bombini + Meliponini + Apini) and a single origin of advanced eusociality in the group (Meliponini + Apini). A serious problem with the reliability of the g1-statistic as a measure of phylogenetic signal is noted.

Keywords: Hymenoptera; Apoidea; Phylogeny; Eusociality; rDNA.

INTRODUCTION

The four tribes comprising the “corbiculate” bees represent the full spectrum of social evolution, ranging from solitary and communal behavior (Euglossini) to primitive eusociality (Bombini) to advanced eusociality (Meliponini and Apini). For this reason, as well as for other behavioral elaborations such as the waggle dance, worker policing, and queen control, the corbiculate bees are of considerable interest to students of animal behavior. One species in particular, *Apis mellifera* (Apini), has been the subject of more biological research than any other insect, primarily because of its economic importance.

Although the monophyly of the corbiculate bees is well supported (“Apidae” sensu Sakagami and Michener, 1987; “apine clade” sensu Roig-Alsina and Michener, 1993), as

is the monophyly of each of the tribes (Michener, 1990, as subfamilies), no agreement exists on the phylogenetic relationships among the tribes. Considering the enormous interest in the group, this situation is unfortunate, and results from conflicting evidence from numerous morphological and molecular studies.

The tribe Apini, or honey bees, comprises one extant genus, *Apis*. All *Apis* species occupy the “advanced eusocial” behavioral grade (sensu Michener, 1969: possessing reproductive division of labor, overlapping generations, and morphologically distinct castes), construct large wax combs, and use the dance language to communicate food location to nestmates (von Frisch, 1967). *Apis* currently consists of seven species (*A. andreniformis*, *A. cerana*, *A. dorsata*, *A. florea*, *A. koschevnikovi*, *A. nigrocincta*, and *A. mellifera*)⁵, though some populations of the “giant honey

¹ Department of Entomology, National Museum of Natural History, MRC 165, Smithsonian Institution, Washington, DC 20560. E-mail: schultz@onyx.si.edu

² Address for correspondence.

³ Department of Entomology, Comstock Hall, Cornell University, Ithaca, NY 14853. *Present address:* Department of Entomology, American Museum of Natural History, Central Park West at 79th Street, New York, NY 10024.

⁴ Department of Environmental Science, Policy, and Management, Wellman Hall, University of California, Berkeley, CA 94720.

⁵ Recently a new species of honey bee, *A. niluensis*, has been proposed (Tingek et al., 1996). Through the courtesy of G. W. Otis one of us (MSE) has been able to examine representatives of these Asian bees. They are in actuality only a distinctive variant or subspecies of *A. cerana* (synonymy by MSE). Refer to Engel (1999b) for current honey bee classification.

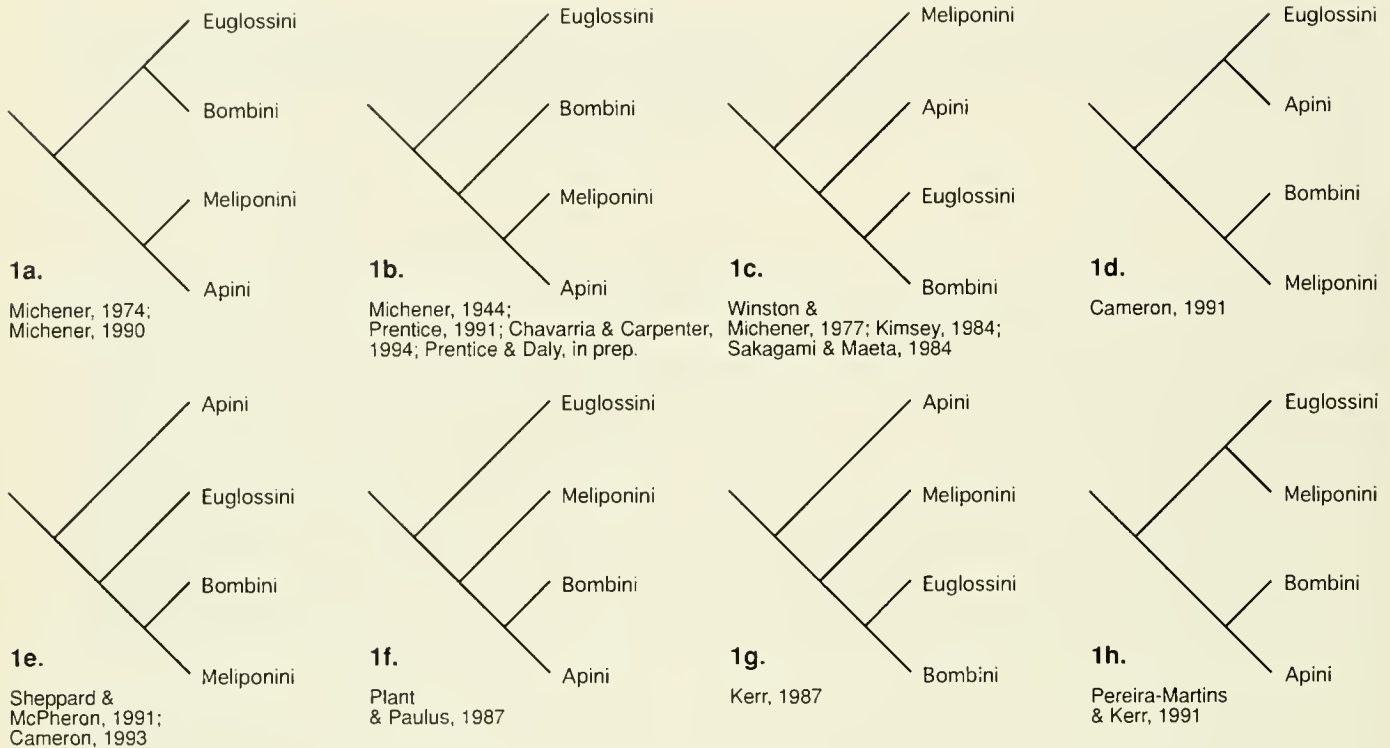

Fig. 1. Previously proposed phylogenies for the corbiculate bee tribes.

bee" *A. dorsata* may represent distinct species. Diversity in *Apis* is discussed in Ruttner (1988) and Smith (1991). Recent phylogenetic analyses of the genus include Alexander (1991a,b), Garnery et al. (1991), Cameron et al. (1992), Willis et al. (1992), Engel and Schultz (1997), and Engel (1998a, 1999b). Crozier and Crozier (1993) have published the complete sequence and organization of the mitochondrial genome for *A. mellifera*.

The Meliponini (stingless bees) are a diverse group of 21 genera with worldwide distribution. All occupy the "advanced eusocial" behavioral grade. The oldest known fossil bee, *Trigona prisca*, is a meliponine remarkably similar to present-day members of the same genus (Michener and Grimaldi, 1988a,b). Wille (1979) presented a phylogenetic hypothesis of the genera and subgenera. Cladistic analyses have been conducted by Michener (1990, for all 21 genera) and Camargo and Pedro (1992a). Camargo and Pedro (1992b) review the systematics, phylogeny, and biogeography of the stingless bees.

The Bombini, or bumble bees, encompass two extant genera, *Bombus* and *Psithyrus*. All *Bombus* species are "primitively" eusocial (i.e., eusocial but lacking morphologically distinct castes), while *Psithyrus* species are social parasites of *Bombus* species. *Bombus* consists of a plethora of subgenera, reviewed by Richards (1968), with recent additions listed by Michener (1990). Based on cladistic

studies of morphological and molecular data (Ito and Sakagami, 1985; Pamilo et al., 1981; Pamilo et al., 1987; Pedersen, 1996; Williams, 1985, 1991), *Bombus* is apparently paraphyletic with respect to *Psithyrus*.

The tribe Euglossini, or orchid bees, consists of five genera of neotropical bees, many of which are large and brightly metallic colored. Euglossines possess extremely long tongues, in some species trailing between their hind legs in flight, and many male euglossines are known to seek out orchids in order to collect oils as possible ingredients in female attractants. No euglossines are eusocial, though some species of *Euglossa* and *Eulaema* are communal. Two genera, *Aglae* and *Exaerete*, are cleptoparasitic. Kimsey (1987) and Engel (1999a) present genus-level phylogenetic analyses of the tribe.

In recent years, 8 of the possible 15 rooted trees for the four corbiculate tribes have been proposed, each based on a particular morphological or molecular data set, and each with its own implications for the evolution of eusocial behavior (Figure 1). Earlier morphological studies (Michener, 1944; Michener, 1974), as well as more recent ones (Michener, 1990; Prentice, 1991; Prentice and Daly, in prep.), have supported a sister-group relationship between the Apini and Meliponini and thus a single origin for advanced eusocial behavior, in spite of disagreement over other details of tree topology (Figs. 1a, 1b). However, morphologi-

cal studies based on other characters (Winston and Michener, 1977; Kimsey, 1984; Plant and Paulus, 1987) suggest that Apini and Meliponini are not sister taxa, and thus support a dual origin for advanced eusociality (Figs. 1c, 1f), as do studies focusing on cytological data (Mello and Kerr, 1984; updated in Kerr, 1987) and nest architecture (Pereira-Martins and Kerr, 1991) (Figs. 1g, 1h). A dual origin is also implied by a molecular phylogeny of 16s mitochondrial rDNA, although different most-parsimonious tree topologies are reported in separate publications discussing the same data (Cameron, 1991, 1993) (Figs. 1d, 1e). One of these topologies (Cameron, 1993) is also supported by a study of the large rDNA subunit gene (Sheppard and McPherson, 1991). A recent "total evidence" analysis incorporating data from a wide variety of studies carried out at different taxonomic levels also supports a "single-origin" scenario (Chavarría and Carpenter, 1994).

The fact that the various data sets for the corbiculate tribes disagree in their phylogenetic implications demonstrates that high levels of homoplasy are present within at least some of them, i.e., a high proportion of presumed morphological or molecular homologies are actually cases of nonhomologous resemblance due to convergence, parallelism, or reversal to an ancestral state.

ACKNOWLEDGMENTS

We thank T.D. Seeley, G. Eickwort, and the Cornell "Social Insects Seminar Group" for stimulating this study. B.A. Alexander, S.A. Cameron, J.M. Carpenter, G. Chavarría, B.N. Danforth, C.D. Michener, J.K. Liebherr, and T.D. Seeley critically read and commented on earlier versions of the manuscript, resulting in substantial improvements. Additional thanks to: R.B. Cocroft and M.J. McDonald for stimulating discussions regarding this material, S. Rehner for aid in the sequence alignment with the *Lasergene* software package, D.W. Roubik for meliponine identifications, J. Sullivan for access to an unpublished manuscript, D. Swofford for permission to use results obtained with PAUP* 4, and J. Wilgenbusch for advice on maximum-likelihood analysis. None of these generous souls is responsible for our errors, conclusions, or opinions.

This study is dedicated to the memory of two great bee systematists and morphologists: George C. Eickwort (1940–1994), who encouraged us to pursue this study, and Byron A. Alexander (1952–1996), who read and commented on an earlier version. We cherish their friendship, we honor their scientific contributions, and we mourn their loss.

METHODS

CHOICE OF DATA SETS

Two data sets bearing on the tribal relationships of the corbiculate bees were analyzed, one consisting of morpho-

logical characters, the other of molecular characters. These two data sets have the virtue of sharing all 16 terminal taxa in common (Appendix 1). Molecular data are Cameron's (1991, 1993) mitochondrial 16s rDNA sequences (Genbank accession numbers L22891–L22906) consisting of 495 nucleotide sites, of which 171 are parsimony-informative. The morphological data, consisting of 25 characters, are drawn from the matrices of Prentice and Daly (in prep., summarized in Prentice, 1991) and Michener (1990). In accord with usual morphological systematic procedure, character homologies were defined with the goal of providing independent items of evidence on phylogeny. Although these characters were originally coded using the corbiculate tribes as terminal taxa (Prentice, 1991), we have specifically examined the 16 species analyzed here to confirm the accuracy of the character states. In order to avoid any vulnerability to the claim that we have employed a circular argument in reconstructing social evolution, the character of social behavior was excluded from the analyses described below. We note, however, that inclusion or exclusion of this character makes no difference in the test results and that the issue of whether to include or exclude characters of interest from phylogenetic analyses is a matter of legitimate debate (e.g., Wenzel, 1997; Zrzavy, 1997; Luckow and Bruneau, 1997).

All other potentially useful tribal-level morphological and molecular data sets were conservatively rejected for use in this study due to a lack of terminal taxa shared in common. Use of such data sets could be justified only under the unwarranted assumption that all species drawn from within the same tribe will be identical in unexamined character states and, when this assumption is not met, could lead to unrealistic reconstructions at ancestral nodes. For instance, although Sheppard and McPherson's (1991) rDNA sequence data include one representative from each of the four tribes as well as an outgroup species in *Anthophora*, in no case is the species the same as one present in the studies included here, with the exception of *Apis mellifera*. Data from a variety of other studies were unusable because they are concerned with relationships within particular tribes and include no character information relevant at the tribal level [e.g., Apini: Lindauer (1956, 1961), Kreil (1975), Sakai et al. (1986), Alexander (1991a,b), Garnery et al. (1991), Willis et al. (1992); Bombini: Williams (1985, 1991); Euglossini: Kimsey (1987); Meliponini: Michener (1990), later revised by Camargo and Pedro (1992a)].

ALIGNMENT

The 16s rDNA data set of Cameron (1991, 1993) consists of 495 nucleotide sites and 16 species (Appendix 1). Initially, various experimental alignments were performed using the computer programs *Malign* (Wheeler and

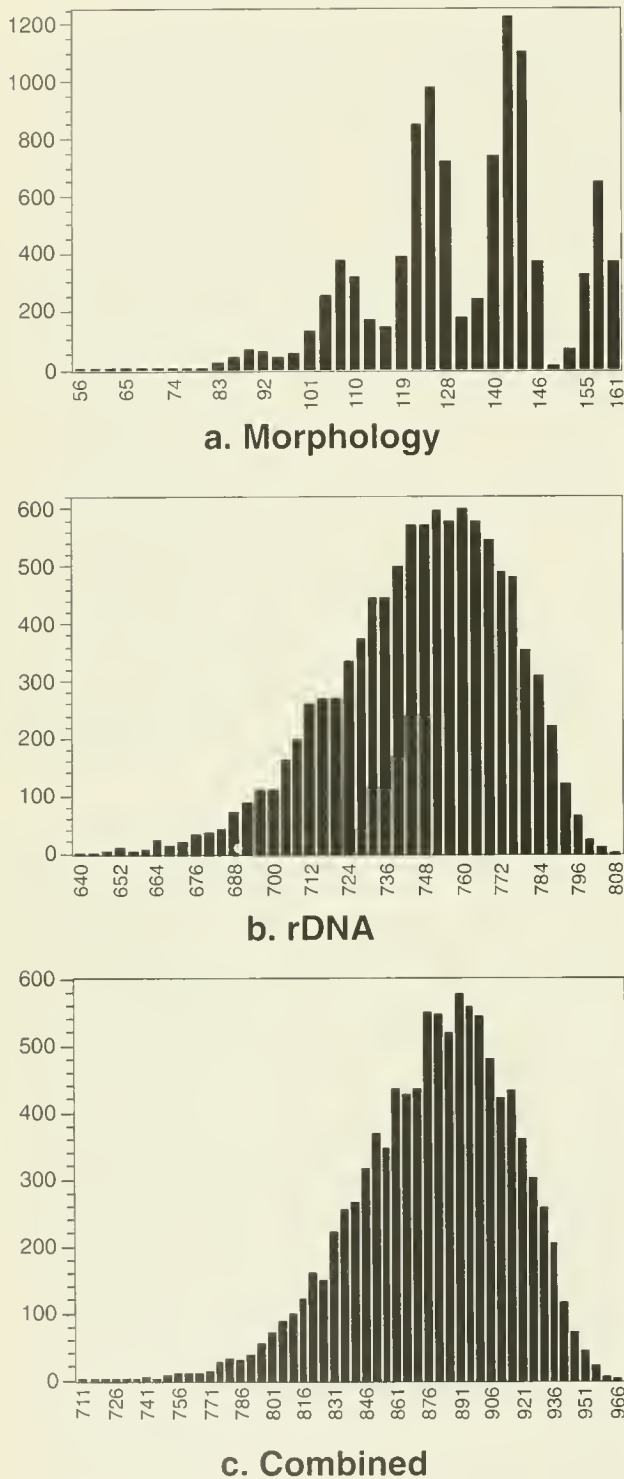

Fig. 2. The distribution of tree lengths (DTL's) for the morphology data set, the 16s rDNA data set, and for the data set produced by their combination, based on 10,000 trees generated by the "random trees" command in *PAUP* 3.1 (Swofford, 1991) (see text). Number of trees is indicated on the y-axis, tree length on the x-axis. Hillis (1991) and Huelsenbeck (1991) have suggested that left-skewness, which is obvious in these three DTL's, indicates that the data contain strong phylogenetic signal.

Gladstein, 1993), GCG (Genetics Computer Group, 1991), *Sequencher 3.0* (Gene Codes Corp., 1995), and *Megalign* (DNASTAR, 1992). Depending upon the parameter settings employed, varying numbers of insertions and deletions were required by these programs; however, all produced essentially the same results, i.e., identical tree topologies and nearly identical tree lengths. Subsequently, alignment by eye was attempted and was judged to be trivial. As submitted to Genbank, there is no length variation across the 16 sequences, and thus no hypothetical insertions or deletions are necessarily required in the few highly variable regions. The alignment requiring no insertions and deletions was favored and was used in all phylogenetic analyses described below.

PHYLOGENETIC ANALYSES

Parsimony analyses were carried out on the morphological data set, the rDNA data set, and the data set resulting from combining the morphological and DNA characters (the "combined" data set) using *PAUP** 4.0d56 (Swofford, 1997) with 10 random-addition heuristic searches and TBR branch-swapping. Bootstrap frequencies for branches (Felsenstein, 1985b) were likewise obtained using *PAUP** 4.0d56 with 1000 pseudoreplicates and 10 random-addition TBR branch-swapping heuristic searches per replicate, and with autapomorphies excluded. Decay indices (a.k.a. Bremer support values or support indices), i.e., the number of extra steps required by the minimal tree in which a particular group does not appear (Bremer, 1988), were obtained by analyzing data with and without non-monophyly constraints in *PAUP** 4.0d56. Maximum-likelihood (ML) analyses of the rDNA data set were also carried out in *PAUP** 4.0d56 under various constraints in order to conduct the ML Kishinjo-Hasegawa (ML K-H) tests described below, and are summarized in Appendix 2. Legitimate disagreement exists over the relative merits of the parsimony vs. the ML criterion. Although this study largely relies on parsimony, ML K-H tests of the rDNA data were conducted in order to avoid any vulnerability to the criticism that considerably different significance values might have been obtained under the ML criterion than those that were obtained under the parsimony criterion.

STATISTICS AND TESTS

Consistency index (C.I.), retention index (R.I.), and permutation tail probability (PTP) statistics were calculated in *PAUP** 4.0d56 (Swofford, 1997); distribution of tree length (DTL) statistics were calculated in *PAUP* 3.1 (Swofford, 1991). PTP values were derived from 1000 heuristic-search permutation runs using TBR branch-swapping. G1 values were generated using the "random trees"

command to generate a distribution of tree lengths for 10,000 randomly selected trees. Tests for significance of the gI values (Hillis, 1991; Donoghue et al., 1992) were carried out for the three data sets by generating 100 permuted matrices in *Data Randomiser* (Trueman, 1992), then generating a distribution of 10,000 trees for each using the "random trees" command in *PAUP* 3.1 (Swofford, 1991). In a test of the usefulness of the gI statistic, described below, 50 permuted matrices were generated and analyzed in the same way. The actual gI value is considered to indicate significant signal if it is more negative than some predetermined fraction (e.g., 0.95) of the gI values for the permuted matrices. For reasons given below, however, the gI value may be a poor measure of phylogenetic DTL skew.

The partition homogeneity test, also known as the incongruence length difference test (Farris et al., 1995), quantifies the between-data-set incongruence as the additional treelength required when two data sets are combined and analyzed as compared to the sum of the treelengths required when the two data sets are analyzed separately. Whether this number is significantly large is determined by finding its position in the distribution of such numbers obtained from analyses of data sets of the same size constructed from characters randomly sampled from the combined data set. We applied the partition homogeneity test to the morphological and rDNA data using *PAUP** 4.0d56 (Swofford, 1997) with 1000 replicates, 10 random-addition TBR branch-swapping heuristic searches per replicate.

The three hypothesis tests (tree comparisons) summarized in Figs. 4, 5, and 6 are concerned only with tribal-level relationships. For this reason, comparison trees were generated to minimize conflict below the tribal level, which would artificially increase the apparent conflict between hypotheses for a given data set. For each comparison and each data set, the alternative trees are the most parsimonious topologies that conform to the tribal-level hypotheses being compared, generated using the minimum necessary constraints in *PAUP** 4.0d56 with 10 random-addition heuristic searches and TBR branch-swapping. In the parsimony analyses these constraints never included the monophyly of the corbiculate bees nor did it include the monophyly of the four tribes, i.e., these features were in all cases natural outcomes of the various analyses. In contrast, the maximum-likelihood analyses included these constraints (Appendix 2).

The four statistical tests employed are not without problems, some of which are pointed out in the descriptions below. One such problem is that all three are *a priori* tests (Kishino and Hasegawa, 1989; Swofford et al., 1996); however, if it is accepted that alternative hypotheses about the evolution of eusociality in the corbiculate bees have been framed *a priori*, this unavoidable problem will affect

only our comparisons of the morphology and the rDNA trees (Fig. 4). In any case, these are the best tests currently available for determining whether a given data set is able to distinguish significantly between two alternative topological hypotheses, and we have employed them here as gross indicators of strength of support (i.e., of character congruence) for one hypothesis relative to an alternative. Given this perspective, our emphasis is less on the precise P-values of the outcomes and more on the relative differences in performance of the morphological data set vs. the rDNA data set. The four tests are:

Wilcoxon's signed-rank test (WSR): The WSR test (Templeton, 1983; Felsenstein, 1985a) compares the number of extra steps (positive and negative) required for each character on one tree relative to the number required on an alternative tree and ranks these numbers according to absolute magnitude. Following the ranking process, the positive and negative values are restored and the separate sums of the positive and negative ranks are compared using a table of significance values (Rohlf and Sokal, 1995: Table V), with the expectation that when the trees explain the data equally well, the difference in sums of positive and negative ranks will not significantly depart from 0. WSR tests were carried out using the "Compare trees" command in *MacClade* 3.06 (Maddison and Maddison, 1992) to obtain extra steps across trees; they were also calculated (with additional precision) in *PAUP** 4.0d56. The WSR test is formally carried out as a one-tailed test; however, following the recommendation of Felsenstein (1985a; see also Larson, 1994, and Mason-Gamer and Kellogg, 1996), the more conservative two-tailed probabilities are used here.

Compare 2 trees test (C2T): Implemented in *PAUP** 4.0d56 (Swofford, 1997), this test is a modification of the T-PTP test (Faith, 1991) and uses as a test statistic the difference in lengths obtained when a given data set is constrained to fit two alternative tree topologies. The significance of this length difference is judged by determining its position in a distribution of such values derived from a series of pseudoreplicates generated by permutations of both data sets (Archie, 1989; Faith, 1991). C2T tests were generated using the "compare 2 trees" command in *PAUP** 4.0d54 (Swofford, 1997) with 1000 branch-and-bound pseudoreplicates. Significance was evaluated under a conservative two-tailed criterion (Engel and Schultz, 1997) rather than under the one-tailed criterion implemented in *PAUP** 4.0d56, which avoids a major problem of this test reported by Mason-Gamer and Kellogg (1996). The related T-PTP test has been criticized for a number of reasons (Carpenter 1992; Swofford et al., 1996), but, as discussed by Engel and Schultz (1997, p. 53), we have attempted to compensate for these problems in the version of the C2T test used here.

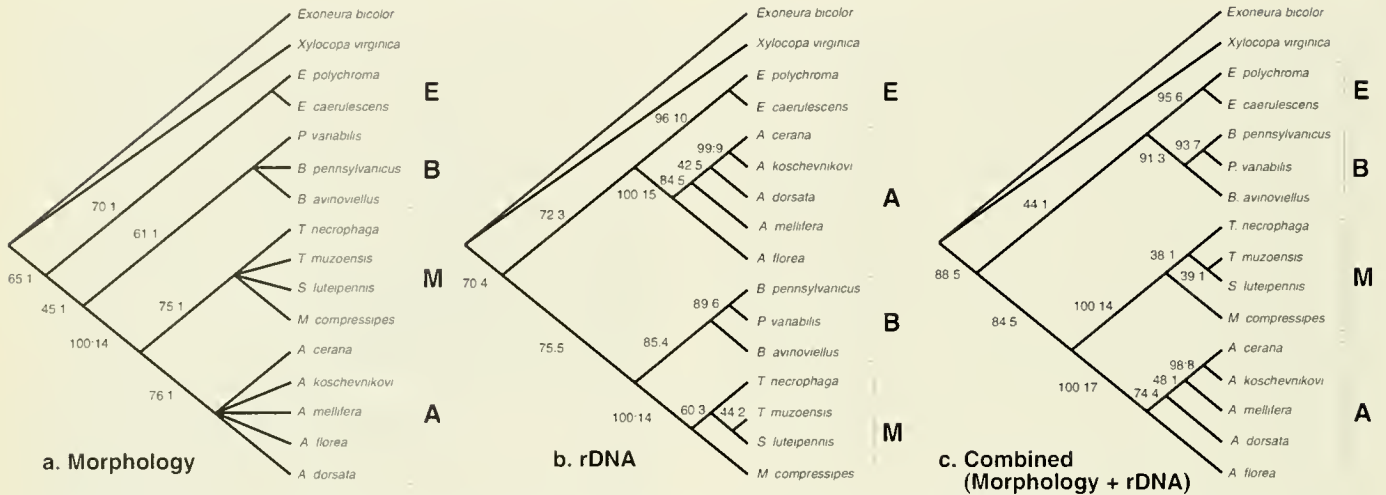

Fig. 3. The results of three unweighted parsimony analyses. Numbers preceding and following the colons indicate bootstrap frequencies and decay indices, respectively, for corresponding branches. Bootstrap frequencies are based on 1000 pseudoreplicates in *PAUP** 4.0d54 (Swofford, 1997) using TBR branch-swapping, 10 random-addition heuristic searches per replicate, and with autapomorphies excluded. (a.) The single most parsimonious tree resulting from the analysis of the morphology data set. Length = 33; C.I. = 0.818; R.I. = 0.953. (b.) The single most parsimonious tree resulting from an analysis of the 16s rDNA data (Cameron 1991, 1993). Length = 517; C.I. = 0.449; R.I. = 0.549. (c.) The single most parsimonious tree resulting from the combination of the rDNA and morphology data sets. Length = 563; C.I. = 0.460; R.I. = 0.599.

Kishino-Hasegawa parametric tests (MP K-H and ML K-H): Kishino and Hasegawa (1989) proposed two tests, one under the parsimony criterion (MP H-K) and one under the maximum-likelihood criterion (ML K-H), that determine the significance of the length/likelihood difference separating two trees based upon a calculated variance about that difference. MP K-H and ML K-H tests were carried out in *PAUP** 4.0d54 (Swofford, 1997). One case, that in which the rDNA data were analyzed with the constraint (Apis + Meliponini) (Fig. 6b), resulted in five equally parsimonious trees, all with the same tribal-level topology and differing only in the within-tribe topologies of the Apini and Meliponini. Because the purpose of these tests is to determine whether there is overlap in the "error ranges" of support for competing hypotheses, Fig. 6b appropriately reports the least significant WSR and MP K-H test values found in comparisons of the rDNA most-parsimonious tree and each of the five equally parsimonious constraint trees. For ML K-H calculations, trees were generated with maximum-likelihood searches via a procedure designed to minimize likelihood differences due to topological incongruence below the tribal level (Appendix 2).

RESULTS AND DISCUSSION

PHYLOGENETIC ANALYSES

A parsimony analysis of the morphological data resulted in a single most-parsimonious tree ("MPT") (Fig. 3a; length = 33, C.I. = 0.818, R.I. = 0.953) that is identical at the tribal level with those of Michener (1944), Prentice (1991), Chavarría and Carpenter (1994), and Prentice and Daly (in prep.) (Figure 1b). As noted above, no character

describing eusociality was included in this analysis; however, when such a character (State 1: eusociality absent, State 2: "primitive" eusociality present, State 3: "advanced" eusociality present) is included, the same tree topology is obtained (length = 35, C.I. = 0.829, R.I. = 0.955, whether or not the states are ordered). A parsimony analysis of the rDNA data set resulted in a single MPT (Fig. 3b; length = 517, C.I. = 0.449, R.I. = 0.549) that is identical to that presented by Cameron (1991; our Fig. 1d). Constraining the topology to conform to Cameron's (1993) tree (our Fig. 1e) required 7 additional steps. A parsimony analysis of the data set composed of the combined morphological and molecular characters resulted in a single MPT (Fig. 3c; length = 563, C.I. = 0.460, R.I. = 0.599) that is identical to that of Michener (1974) and Michener (1990) (Fig. 1a).

OVERALL CHARACTER CONGRUENCE ("PHYLOGENETIC SIGNAL")

A number of statistics have been proposed for assessing overall levels of character congruence ("phylogenetic signal") in data sets, some of them controversial. Four such measures were used to evaluate the morphological and rDNA data sets: 1) the consistency index (C.I.) (Kluge and Farris, 1969), 2) the retention index (R.I.) (Farris, 1989), 3) the PTP test (Archie, 1989; Faith and Cranston, 1991), and 4) the distribution of tree lengths (DTL) (Hillis, 1991; Huelsenbeck, 1991). As indicated in Table 1, the C.I. for the rDNA data (0.449) is considerably worse than the expected C.I. (0.634) for a study with 14 taxa, based on the survey of Sanderson and Donoghue (1989). In contrast, the C.I. for the morphological data set (0.818) far exceeds this amount. No similar criterion is available for the R.I. mea-

Table 1. Various measures of overall character congruence ("phylogenetic signal") for the morphology and 16s rDNA data sets for the corbiculate bees, considered separately and when they are combined and analyzed as a single matrix. According to a survey of 60 cladistic analyses by Sanderson and Donoghue (1989), the expected C.I. for 16 taxa is 0.634; the values for the rDNA data set and for the combined data set fall well below this expectation. The negative g_1 values for both the rDNA and the combined data sets indicate left-skewness and hence phylogenetic signal according to the criterion of Hillis (1991) and Huelsenbeck (1991); however, exploration of a recommended significance test (Hillis, 1991; Donoghue et al., 1992) indicates that the g_1 statistic may be a poor indicator of phylogenetic signal (see text). PTP tests (Faith and Cranston, 1991) indicate significant phylogenetic signal in all three data sets.

	C.I.	R.I.	g_1	PTP "P" value
Morphology	0.818	0.953	-0.416	< 0.01
rDNA	0.449	0.549	-0.584	< 0.01
Combined	0.462	0.602	-0.582	< 0.01

sure, but the value for the morphological data (0.955) is considerably higher than that for the rDNA data (0.549). Thus, based on C.I. and R.I., there is reason to suspect that the rDNA data set is considerably "noisier" than the morphological data set, although this additional homoplasy could be at least partly a natural consequence of the greater number of characters and character states present in the rDNA data set.

The PTP test (Faith and Cranston, 1991) indicates that the character congruence present in both the morphological and rDNA data sets departs significantly from that expected simply due to random noise ($P < 0.001$). Thus, based on this demonstrably weak criterion (Carpenter, 1992; Farris et al., 1994), both data sets contain significant phylogenetic signal.

Hillis (1991) and Huelsenbeck (1991) have suggested that left-skewness of the distribution of tree lengths (DTL's) for a given data set is an indicator of phylogenetic signal. Visual inspection of the DTL's indicates strong left-skewness in both data sets (Fig. 2), as does the negative value of the g_1 statistic obtained for these distributions (Table 1). However, implementation of a modified version of the test suggested by Hillis (1991; modified by Donoghue et al., 1992) for determining the significance of a particular g_1 value suggests that this statistic may not be a reliable indicator of the kind of skewness that is of interest in phylogenetic studies. To test for the significant departure of the actual g_1 values from those that might be expected in the absence of congruence, we obtained g_1 statistics for 100 matrices for each data set, permuted in the manner of Archie (1989) and Faith and Cranston (1991). For the molecular data, the g_1 values for the permuted matrices were always higher (i.e., more positive) than the actual g_1 value ($P < 0.01$), indicating a significant departure from the ex-

pectation from random noise; however, for the morphological data the g_1 values for the permuted matrices were consistently more negative ($P > 0.99$) than the g_1 value for the actual data, which, given Hillis' (1991) proposed test, would lead to a conclusion that the morphological data set contains non-significant phylogenetic signal (i.e., congruence).

Because the DTL for the morphological data clearly meets the criterion of possessing a "highly asymmetrical distribution with few trees near the optimal solution" (Hillis, 1991), and because the presence of highly significant signal is indicated by the other measures employed, we chose to test the hypothesis that the g_1 statistic might be an imperfect measure of phylogenetic DTL skew. In order to do so, we altered the minimum number of state assignments required to render the morphological data set perfectly congruent (C.I. = R.I. = 1.00), then subjected this altered data set to 50 permutations. The g_1 statistics for the permuted data sets were more negative than the g_1 statistic for the real data (-0.416) in 48 of the 50 runs, providing strong evidence against the reliability of the g_1 statistic as an indicator of phylogenetic signal. As suggested by Hillis (1991; personal communication), other odd central moments of the distribution may ultimately prove to be more reliable indicators of phylogenetic signal than the g_1 statistic. Alternatively, Källersjö et al. (1992) have suggested that the DTL approach is seriously flawed.

BETWEEN-DATA-SET INCONGRUENCE

At the level of the corbiculate tribes, the topologies produced by separate analyses of the two data sets are obviously incongruent (Figs. 3a, 3b). This incongruence was found to be highly significant ($P = 0.002$) by the partition homogeneity test (Farris et al., 1995). Obviously, strong disagreement exists between the data sets. This disagreement cannot be due to the effect of heterogeneity in base frequencies between taxa in the rDNA data set because a chi-square test of homogeneity of base frequencies across taxa conducted in *PAUP** 4.0d56 (Swofford, 1997) results in accepting the null hypothesis of homogeneity ($P = 0.99983508$). The particular topological features that are the primary source of this disagreement may to some extent be identified by studying the support values for various branches and how these values increase/decrease when the data are combined and analyzed (Fig. 3c) (Carpenter and Nixon, 1997).

SUPPORT FOR CLADES

Judging from bootstrap resampling frequencies (Felsenstein, 1985b) and decay indices (Bremer, 1988), support for branches in the morphology-based phylogeny (Fig. 3a) is consistently low (bootstrap frequency < 76%, decay

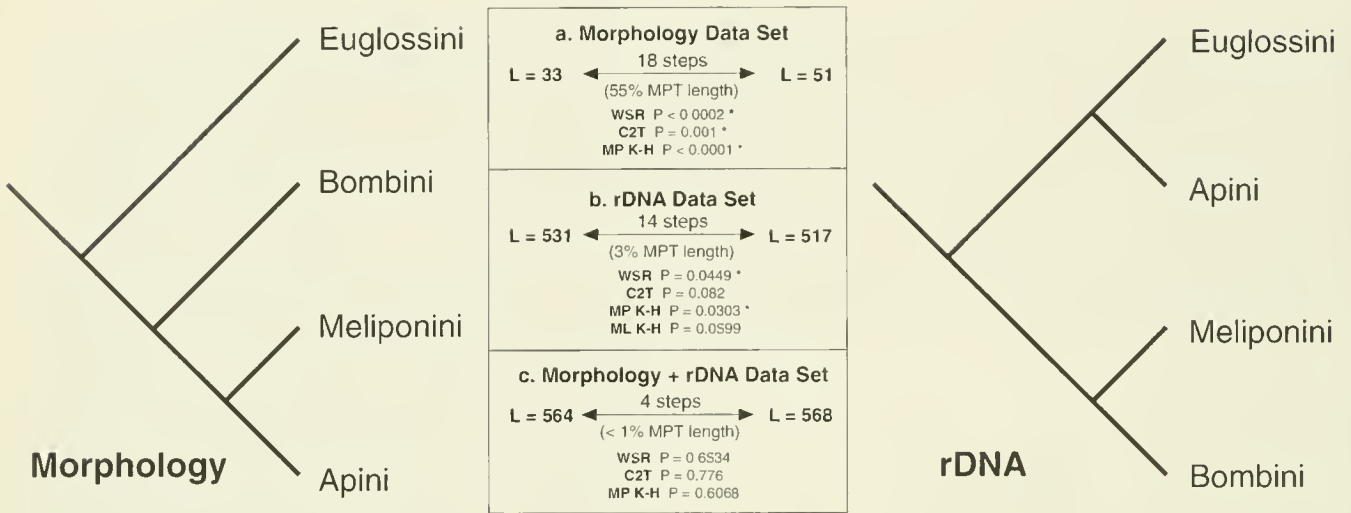

Fig. 4. Statistical tests of alternative hypotheses of tribal-level relationships in the corbiculate bees. WSR = Wilcoxon's signed-rank test, C2T = Compare 2 trees test, MP K-H = parsimony-based Kishino-Hasegawa parametric test, ML K-H = likelihood-based Kishino-Hasegawa parametric test. (Left) the single most-parsimonious tree (MPT) resulting from unweighted parsimony analysis of the morphology data set. (Right) The MPT resulting from unweighted parsimony analysis of the rDNA data set. Asterisks (*) indicate significant power to distinguish between the alternative hypotheses at the 95% level. See text for description of tests. The ability of the morphology data set to distinguish between the two topologies is significant near the limits of resolution for all three tests, whereas the ability of the molecular data set to distinguish between the two topologies is non-significant at the 95% confidence level in two out of four tests. The combined data set is unable to distinguish between the two topologies by any of the three test criteria, indicating serious erosion of character support for tribal-level groupings due to the union of two significantly conflicting data sets. (Note that neither topology represents the most parsimonious solution for the combined data set.)

index = 1), with one exception: support for the sister-group relationship (Apini + Meliponini) is remarkably high (bootstrap frequency = 100%, decay index = 14 = 42% of MPT length).

Bootstrap and decay index branch support for the monophyly of each of the tribes Euglossini, Meliponini, and Apini in the rDNA tree (Fig. 3b) is quite high (bootstrap frequency > 95%, decay index > 10). However, support for tribal-level relationships is much lower: The sister-group relationship (Euglossini + Apini) is supported by a bootstrap frequency of 72% and a decay index of 3 (0.6% of MPT length); the sister-group relationship of Bombini + Meliponini is supported by a bootstrap frequency of 75% and a decay index of 5 (1% of MPT length). This decrease in support at the tribal level may indicate a limit in the usefulness of the 16s rDNA gene sequence characters due to saturation (multiple "hits" at informative sites) at deeper nodes within the tree.

The group (Apini + Meliponini), present on the morphology MPT (Fig. 3a), also appears on the combined-data MPT (Fig. 3c). However, due to conflict between the morphological and molecular data sets, bootstrap/decay index support for this group is eroded from 100%/14 in the morphology MPT to 84%/5 in the combined-data MPT.

HYPOTHESIS TESTS

Even when it can be shown, e.g., with the partition homogeneity (ILD) test, that significant overall disagreement exists between two data sets, the localization of that disagreement to various groups within alternative topologies remains a complex problem. This problem can be made more manageable by addressing the ability of the individual data sets to discriminate between narrowly defined alternative hypotheses. We have chosen to adopt this hypothesis-testing approach to focus on what is arguably the greatest single biological implication of the phylogeny of the corbiculate bees, the evolution of eusociality within the tribe.

HYPOTHESIS TEST 1:

MORPHOLOGY MPT TOPOLOGY VS. rDNA MPT TOPOLOGY

When the morphological data are constrained to fit the tribal-level topology favored by the rDNA data, a length difference of 18 extra steps (55% of the MPT length) is required (Fig. 4a). This length difference is significant to the limits of resolution in two of the three tests employed, indicating that the morphological data very strongly favor the MPT over the alternative topology. In light of the bootstrap frequency and decay index corresponding to the branch supporting (Apini + Meliponini) on the morphology tree (Fig. 3a), this is perhaps unsurprising.

“General” Eusociality Single vs. Multiple Origins

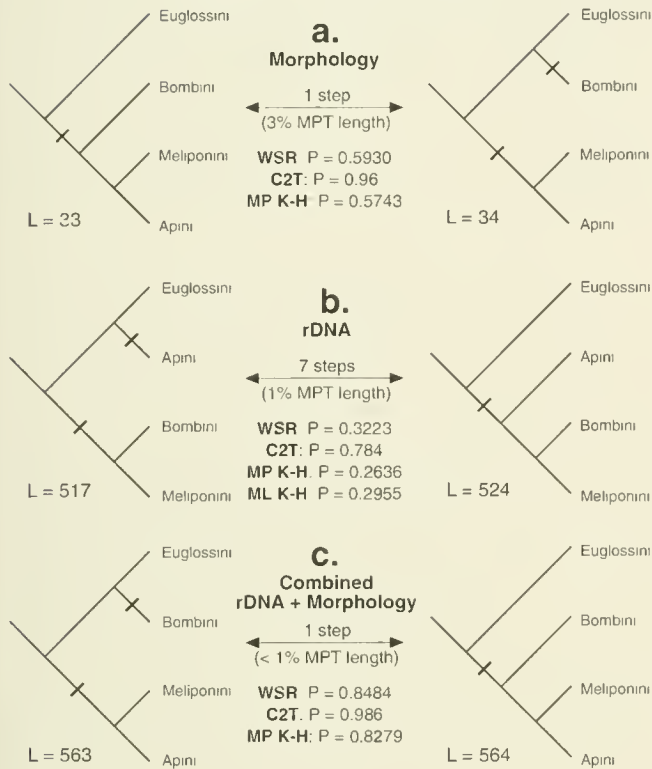

Fig. 5. Statistical tests of alternate hypotheses for the origin of the “general” eusocial behavior present in the Bombini, Apini, and Meliponini, with no distinction made between “primitive” or “advanced” eusocial states. See Fig. 4 caption for test abbreviations; Tree lengths are the results of unweighted parsimony analyses; tick-marks represent origins or losses of general eusociality. None of the three data sets is able to distinguish between alternative hypotheses of single vs. dual origins of eusociality (or, alternatively, a basal gain and subsequent loss in the Euglossini) to a degree approaching statistical significance.

When the rDNA data are constrained to fit the tribal-level phylogeny favored by the morphology data, a length difference of 14 extra steps (3% of the MPT length) is required (Fig. 4b). This length difference is significant at the 95% confidence level in two of the four tests employed, and significant at the 90% level in all four tests.

A nonsignificant length difference of 4 steps (< 1% of the MPT length) separates the two tree lengths obtained when the combined (morphology + rDNA) data are constrained to fit the two alternative topologies (Fig. 4c).

Based on the results of these tests, we conclude that the morphological data strongly reject the rDNA topology (99.9% confidence level), whereas the rDNA data less strongly reject the morphology topology (91% to 96% levels). At this stage in hypothesis-testing it is unclear precisely which features of topological disagreement are most

significantly rejected by each data set, but it bears noting that, for the morphological data, the vast majority of tribal-level character support is concentrated on the branch supporting the monophyly of the group (Apini + Meliponini) (Fig. 3a).

HYPOTHESIS TEST 2:

SINGLE VS. DUAL ORIGIN(S) OF GENERAL EUSOCIALITY

The MPT for the morphological data set (Fig. 3a) favors a single origin for eusociality in the corbiculate bees, followed by a subsequent single origin of advanced eusociality in the (Apini + Meliponini). However, constraining these data to fit the shortest alternative, favoring a separate origin of eusociality in the Bombini, requires a tree only one step longer (3% of the MPT length), a difference that is found to be non-significant by all three tests (Fig. 5a).

The MPT for the rDNA data set (Fig. 3b) favors a dual origin of eusociality, arising once in the ancestor of the Bombini and Meliponini, and separately in the ancestor of the Apini (or, alternatively, arising once at the base of the corbiculate bees with a subsequent loss in the Euglossini, requiring the same number of evolutionary steps). However, constraining the rDNA data to fit a single-origin hypothesis requiring the monophyletic group (Bombini + Meliponini + Apini) requires a tree seven steps longer, a length difference found to be nonsignificant by all four tests (Fig. 5b).

As in the previous hypothesis test, the combined (morphology + rDNA) data are unable to distinguish between the two topologies at any level of confidence (Fig. 5c).

Thus, neither data set significantly opposes the grouping (Bombini + Meliponini + Apini), with the result that a hypothesis of a single origin of eusociality in the corbiculate bees cannot be ruled out on the basis of either the morphological or molecular data.

HYPOTHESIS TEST 3:

SINGLE VS. DUAL ORIGIN(S) OF “ADVANCED” EUSOCIALITY

The MPT for the morphological data set favors a single origin for “advanced” eusociality (characterized by a sterile worker caste), present in the Apini and Meliponini (Fig. 3a). Constraining the morphological data to fit the shortest tree in which a dual origin is required adds 14 extra steps (42% of the MPT length), a difference that is found to be significant at the > 95% level by all three tests employed (Figure 6a).

The MPT for the rDNA data favors a dual origin (Fig. 3b), and constraining these data to fit the five shortest equally parsimonious trees in which a single origin is supported adds 12 extra steps (2% of MPT length). This length difference was found to be non-significant at the 95% con-

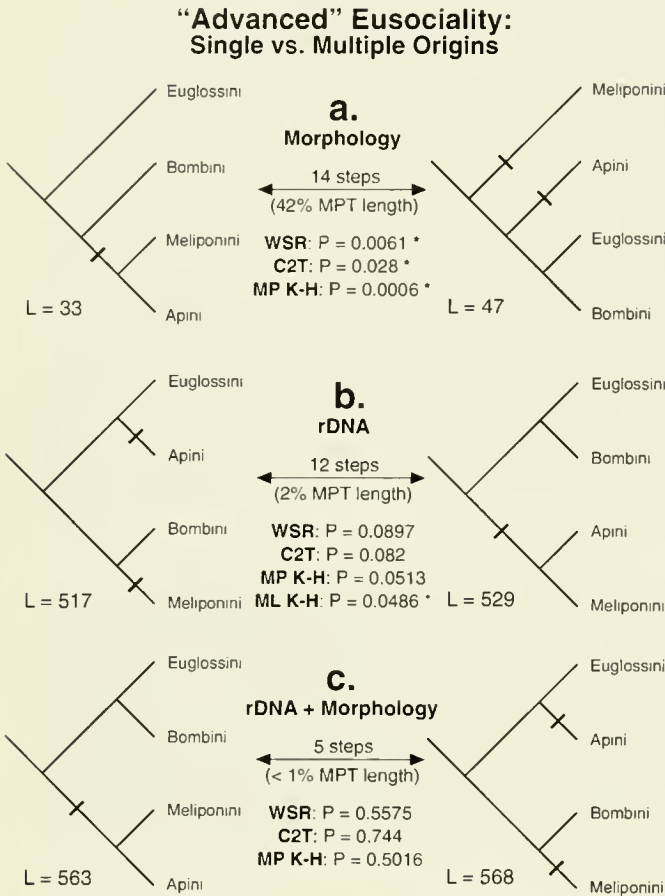

Fig. 6. The ability of the three data sets to distinguish between alternate hypotheses for the origin of the “advanced” eusocial behavior present in the Apini and Meliponini. See Figure 4 caption for test abbreviations. Tick-marks represent origins or losses of advanced eusociality; asterisks (*) indicate significant power to distinguish between the alternative hypotheses at the 95% level. Tree-lengths are the results of unweighted parsimony analyses. (a.) The most parsimonious tree for the morphology data set favors a single origin of advanced eusociality; a dual origin (or, alternatively, a gain and a loss) requires 14 extra steps, judged to be highly significant in all three tests. (b.) The most parsimonious tree for the 16s rDNA data supports a dual parallel origin of advanced eusociality. A single origin requires a tree 12 steps longer, a difference found to be non-significant at the 95% confidence level by all three parsimony-based tests. The topology difference was found significant at the 95% level, however, under the ML K-H test (see text). (c.) When the data are combined and analyzed, the resulting MPT favors a single origin of advanced eusociality. However, the unweighted length difference between this topology and the alternative is now only 5 steps, found to be nonsignificant by all three tests.

confidence level in three of the four tests employed; however, all tests found significance at the 90% level. Under the maximum-likelihood criterion, the ML K-H test found a significant difference in character support for the two trees at the 95% level (Fig. 6b).

Not surprisingly, as in both previous hypothesis tests, the combined data are again unable to distinguish significantly between the two alternatives (Fig. 6c).

Based on these results, we conclude that the morphological data very strongly favor the grouping (Apini + Meliponini), whereas the rDNA data strongly (but less strongly) oppose it, favoring instead the grouping (Bombini + Meliponini). Based on the results of Hypothesis Test 2, above, the position of the Apini outside of (Bombini + Meliponini) plays little or no role in the preference of the rDNA data for one topology over the other, i.e., the grouping (Euglossini + Apini) lacks significant support.

CONCLUSION

There is clearly strong conflict between the morphological and rDNA data sets, and this conflict appears to exceed what might be expected from random noise. It might be conjectured that this conflict is due to rampant, concerted parallelism in one or the other data set, e.g., convergence in multiple details of worker morphology in the Meliponini and Apini, or parallel, site-specific base changes in the 16s rDNA molecule of the Apini and Euglossini. In the absence of evidence for such phenomena, this conflict will only be resolved by new character data appropriate to the problem. Based on the foregoing tests, however, we conclude that neither data set provides a significant reason for rejecting the group (Bombini + Meliponini + Apini) (Figs. 5a and 5b), thus allowing to stand the null hypothesis of a single origin for general eusociality within the corbiculate bees. A single origin (as opposed to multiple origins) is certainly the appropriate null hypothesis for further inquiry, based both upon Hennig’s (1966: 121–122) “auxiliary principle” and upon the highly conservative (i.e., uniformly fixed) distribution of this character across species within the three tribes (Schultz et al., 1996). The origin of so-called “advanced” eusociality is more problematic, however. While the morphological data strongly support a single origin (Fig. 6a), the rDNA data also provide strong (if somewhat more equivocal) evidence in favor of either a dual origin or a single origin with a subsequent loss of morphological castes in the Bombini (Fig. 6b).

Based on morphological and behavioral characters, Darwin (1859: 224–235) proposed that the stingless bees (Meliponini) are intermediate between the more primitive bumble bees (Bombini) and the more derived honey bees (Apini). In spite of the conflict between the data sets and in the absence of additional data, we conclude that the preponderance of evidence favors Darwin’s implied topology (our Fig. 3a) and its implication of a single origin for general eusociality and a single origin for “advanced” eusociality. This evidence includes:

1) Judging from the C.I. value, the rDNA data set, which contradicts (Apini + Meliponini), has a demonstrably higher noise level than does the much smaller morphological data set (Table 1). That this noise is concentrated

at more ancient phylogenetic levels is supported by the relatively higher bootstrap values on more recent branches (Fig. 3b), suggesting that the average rate of evolution in 16s rDNA characters may be too rapid to preserve information on tribal-level relationships. The presence of strong signal on recent (within-tribe) branches is supported by perfect congruence between the rDNA data and a morphological data set specific for the genus *Apis* (Engel and Schultz, 1997). Genes better suited for resolving tribal-level relationships within the corbiculate bees might include elongation factor 1-alpha (Friedlander et al., 1992; Friedlander et al. 1994; T. Schultz, unpublished data) and dopa decarboxylase (Fang et al., 1997).

2) As indicated both by the bootstrap frequency (100%), decay index (14 steps) (Fig. 3a), and highly significant results of the three statistical tests ($P > 0.97$) (Fig. 6a), the grouping (Meliponini + Apini) is well supported when the morphological data set is analyzed separately, whereas the alternative tribal grouping of (Bombini + Meliponini) is considerably less well supported when the rDNA data set is analyzed separately (bootstrap frequency = 75%, decay index = 5; $0.90 < P < 0.95$) (Figs. 3b and 6b).

3) When the data are combined and analyzed, the resulting topology continues to support the grouping (Apini + Meliponini) with a reasonably high bootstrap value of 85%, despite the presence of strong within-data-set conflict. Further, the combined data provide only minimal reason for opposing a single origin of general eusociality, as a tree of only one additional step is required to unite (Bombini + Apini + Meliponini), a step that is provided by the inclusion in the analysis of an ordered multistate character "eusociality absent/eusociality present/advanced eusociality present." It bears repeating, however, that character conflict is so high in the combined data set that it is unable to distinguish between any of the hypotheses tested at reasonable significance levels (Figs. 3c, 4c, 5c, and 6c).

4) The grouping (Apini + Meliponini) accords with the fact that fossil species of *Electrapis* are intermediate in some character states for both tribes (Zeuner and Manning, 1976; Prentice, 1991; Engel, 1998b, unpublished data), a condition that might be expected in a species little diverged from the most recent common ancestor of (Apini + Meliponini).

5) The sister-group status of the Apini and Meliponini is also supported by a tribal-level analysis of the corbiculate bees (Chavarría and Carpenter, 1994) that adopts a "total evidence" approach in attempting to incorporate data from a wide variety of studies carried out at different taxonomic levels.

6) Unless the branch lengths connecting tribal ancestral nodes and terminal taxa within the tribes Bombini, Apini, and Meliponini are vastly shorter than branch lengths connecting tribal-level ancestral nodes with each

other, the characters of eusociality and "advanced" eusociality are distributed across taxa in a pattern that is quite inconsistent with multiple parallel origins (Schultz et al., 1996). Rather, the observed fixation of eusociality across entire tribes of species within the corbiculate bees, as well as its fixed absence in the Euglossini and the two outgroup genera, suggest extreme conservatism in transitions between the absence of eusociality, the presence of general eusociality, and the presence of advanced eusociality. This conservatism, combined with the principle of parsimony, suggests that Darwin's (1859) grouping (Euglossini (Bombini (Meliponini + Apini))) constitutes the logical null hypothesis for corbiculate bee phylogeny that has yet to be definitively rejected by the available data.

LITERATURE CITED

- Alexander, B. A. 1991a. Phylogenetic analysis of the genus *Apis* (Hymenoptera: Apidae). *Annals of the Entomological Society of America* 84: 137-149.
- Alexander, B. A. 1991b. A cladistic analysis of the genus *Apis*. Pp. 1-28, in D. R. Smith (ed.), *Diversity in the genus Apis*. Oxford: Westview Press.
- Archie, J. W. 1989. A randomization test for phylogenetic information in systematic data. *Systematic Zoology* 38: 239-252.
- Bremer, K. 1988. The limits of amino acid sequence data in angiosperm phylogenetic reconstruction. *Evolution* 42: 795-803.
- Camargo, J. M. F. and S. R. M. Pedro. 1992a. Sistemática de Meliponinae (Hymenoptera, Apidae): Sobre a polaridade e significado de alguns caracteres morfológicos. Pages 45-49, in C. d. Cruz Landim and J. C. Netto (eds.), *Anais do encontro brasileiro sobre biologia de abelhas e outros insetos sociais*. Naturalia (No. especial).
- Camargo, J. M. F. and S. R. M. Pedro. 1992b. Systematics, phylogeny, and biogeography of the Meliponinae (Hymenoptera, Apidae): a mini-review. *Apidologie* 23: 509-522.
- Cameron, S. A. 1991. A new tribal phylogeny of the Apidae inferred from mitochondrial DNA sequences. Pages 71-87, in D. R. Smith (ed.), *Diversity in the genus Apis*. Oxford: Westview Press.
- Cameron, S. A. 1993. Multiple origins of advanced eusociality in bees inferred from mitochondrial DNA sequences. *Proceedings of the National Academy of Science USA* 90: 8687-8691.
- Cameron, S. A., J. N. Derr, A. D. Austin, J. B. Woolley, and R. A. Wharton. 1992. The application of nucleotide sequence data to phylogeny of the Hymenoptera: A review. *Journal of Hymenoptera Research* 1: 63-79.
- Carpenter, J. M. 1992. Random cladistics. *Cladistics* 8: 147-153.
- Carpenter, J. M. and K. C. Nixon. 1997 (1996). On simultaneous analysis. *Cladistics* 12: 221-241.
- Chavarría, G. and J. M. Carpenter. 1994. "Total evidence" and the evolution of highly social bees. *Cladistics* 10: 229-258.
- Crozier, R. H. and Y. C. Crozier. 1993. The mitochondrial genome of the honeybee *Apis mellifera*: complete sequence and genome organization. *Genetics* 133: 97-117.
- Darwin, C. 1859. *On the Origin of Species by Means of Natural Selection or the Preservation of Favoured Races in the Struggle for Life*. London: John Murray.
- DNASTAR Inc. 1992. Lasergene software, Madison, WI.
- Donoghue, M. J., R. G. Olmstead, J. F. Smith, and J. D. Palmer. 1992. Phylogenetic relationships of Dipsacales based on rbcL sequences. *Annals of the Missouri Botanical Garden* 79: 333-345.
- Engel, M. S. 1998a. Fossil honey bees and evolution in the genus *Apis*

- (Hymenoptera: Apidae). *Apidologie* 29: 265-281.
- Engel, M. S. 1998b. A new species of the Baltic amber bee genus *Electrapis* (Hymenoptera: Apidae). *Journal of Hymenoptera Research* 7: 94-101.
- Engel, M. S. 1999a. The first fossil *Euglossa* and phylogeny of the orchid bees (Hymenoptera: Apidae; Euglossini). *American Museum Novitates* (in press).
- Engel, M. S. 1999b. The taxonomy of recent and fossil honey bees (Hymenoptera: Apidae; *Apis*). *Journal of Hymenoptera Research* 8 (in press).
- Engel, M. S. and T. R. Schultz. 1997. Phylogeny and behavior in honey bees (Hymenoptera: Apidae). *Annals of the Entomological Society of America* 90: 43-53.
- Faith, D. P. 1991. Cladistic permutation tests for monophyly and nonmonophyly. *Systematic Zoology* 40: 366-375.
- Faith, D. P. and P. S. Cranston. 1991. Could a cladogram this short have arisen by chance alone? On permutation tests for cladistic structure. *Cladistics* 7: 1-28.
- Fang, Q. Q., S. Cho, J. C. Regier, C. Mitter, M. Matthews, R. W. Poole, T. P. Friedlander, and S. Zhao. 1997. A new nuclear gene for insect phylogenetics: Dopa decarboxylase is informative of relationships within Heliiothinae (Lepidoptera: Noctuidae). *Systematic Biology* 46: 269-283.
- Farris, J. S. 1989. The retention index and the rescaled consistency index. *Cladistics* 5: 417-419.
- Farris, J. S., M. Källersjö, A. G. Kluge, and C. Bult. 1994. Permutations. *Cladistics* 10: 65-76.
- Farris, J. S., M. Källersjö, A. G. Kluge, and C. Bult. 1995. Constructing a significance test for congruence. *Systematic Biology* 44: 570-572.
- Felsenstein, J. 1985a. Confidence limits on phylogenies with a molecular clock. *Systematic Zoology* 34: 152-161.
- Felsenstein, J. 1985b. Confidence limits on phylogenies: an approach using the bootstrap. *Evolution* 39: 783-791.
- Friedlander, T. P., J. C. Regier, and C. Mitter. 1992. Nuclear gene sequences for higher level phylogenetic analysis: 14 promising candidates. *Systematic Biology* 41: 483-490.
- Friedlander, T. P., J. C. Regier, and C. Mitter. 1994. Phylogenetic information content of five nuclear gene sequences in animals: Initial assessments of character sets from concordance and divergence studies. *Systematic Biology* 43: 511-525.
- Frisch, K. von. 1967. *The Dance Language and Orientation of Bees*. Cambridge, Massachusetts: Harvard University Press.
- Garnery, L., D. Vautrin, J. M. Cornuet, and M. Solignac. 1991. Phylogenetic relationships in the genus *Apis* inferred from mitochondrial DNA sequence data. *Apidologie* 22: 87-92.
- Gene Codes Corporation. 1995. *Sequencher* version 3.0. P.O. Box 3369, Ann Arbor, Michigan 48106.
- Genetics Computer Group. 1991. *Program Manual for the GCG Package*, version 7, April 1991, 575 Science Drive, Madison, Wisconsin, USA 53711.
- Hasegawa, M., H. Kishino, and T. Yano. 1985. Dating of the human-ape splitting by a molecular clock of mitochondrial DNA. *Journal of Molecular Evolution* 21: 160-174.
- Hennig, W. 1979. *Phylogenetic Systematics*. Urbana: University of Illinois Press.
- Hillis, D. M. 1991. Discriminating between phylogenetic signal and random noise in DNA sequences. Pp. 278-294, in M. M. Miyamoto and J. Cracraft (eds.) *Phylogenetic Analysis of DNA Sequences*. New York: Oxford University Press.
- Huelsenbeck, J. P. 1991. Tree-length distribution skewness: an indicator of phylogenetic information. *Systematic Zoology* 40: 257-270.
- Ito, M. and S. F. Sakagami. 1985. Possible synapomorphies of the parasitic bumblebees (*Psithyrus*) with some nonparasitic bumblebees (*Bombus*) (Hymenoptera: Apidae). *Sociobiology* 10: 105-119.
- Källersjö, M. J., J. S. Farris, A. G. Kluge, and C. Bult. 1992. Skewness and permutation. *Cladistics* 8: 275-287.
- Kerr, W. E. 1987. Sex determination in bees. XVII. Systems of caste determination in the Apinae, Meliponinae and Bombinae and their phylogenetical implications. *Revista Brasileira de Genética* 10: 685-694.
- Kimsey, L. S. 1984. A re-evaluation of the phylogenetic relationships in the Apidae (Hymenoptera). *Systematic Entomology* 9: 435-441.
- Kimsey, L. S. 1987. Generic relationships within the Euglossini (Hymenoptera: Apidae). *Systematic Entomology* 12: 63-72.
- Kishino, H. and M. Hasegawa. 1989. Evaluation of the maximum likelihood estimate of the evolutionary tree topologies from DNA sequence data, and the branching order in Hominoidea. *Journal of Molecular Evolution* 29: 170-179.
- Kluge, A. G. and J. S. Farris. 1969. Quantitative phyletics and the evolution of anurans. *Systematic Zoology* 18: 1-32.
- Kreil, G. 1975. The structure of *Apis dorsata* melittin: phylogenetic relationships between honeybees as deduced from sequence data. *FEBS Letters* 54:100-102.
- Larson, A. 1994. The comparison of morphological and molecular data in phylogenetic systematics. Pp. 371-390, in B. Schierwater, B. Streit, G. P. Wagner, and R. DeSalle (eds.), *Molecular Ecology and Evolution: Approaches and Applications*. Basel: Birkhäuser Verlag.
- Lindauer, M. 1956. Über die Verständigung bei indischen Bienen. *Zeitschrift für Vergleichende Physiologie* 38: 521-557.
- Lindauer, M. 1961. *Communication Among Social Bees*. Cambridge, Massachusetts: Harvard University Press.
- Luckow, M. and A. Bruneau. 1997. Circularity and independence in phylogenetic tests of ecological hypotheses. *Cladistics* 13: 145-151.
- Maddison, W. P. and D. R. Maddison. 1992. *MacClade: Analysis of Phylogeny and Character Evolution*, Version 3.06. Computer program and book. Sunderland, Massachusetts: Sinauer.
- Mason-Gamer, R. J. and E. A. Kellogg. 1996. Testing for phylogenetic conflict among molecular data sets in the tribe Tritaceae (Gramineae). *Systematic Biology* 45: 524-545.
- Mello, M. L. S. and W. E. Kerr. 1984. Histochemistry of salivary gland and Malpighian tubule secretion contributing to the cocoon in *Plebeia droryana* and *Scaptotrigona postica*. *Zoologischer Anzeiger (Jena)* 213: 177-189.
- Michener, C. D. 1944. Comparative external morphology, phylogeny, and a classification of the bees (Hymenoptera). *Bulletin of the American Museum of Natural History* 82: 151-326.
- Michener, C. D. 1969. Comparative social behavior of bees. *Annual Review of Entomology* 14: 299-342.
- Michener, C. D. 1974. *The Social Behavior of the Bees: A Comparative Study*. Cambridge, Massachusetts: Harvard University Press.
- Michener, C. D. 1990. Classification of the Apidae (Hymenoptera). *University of Kansas Science Bulletin* 54: 75-164.
- Michener, C. D. and D. A. Grimaldi. 1988a. A *Trigona* from late Cretaceous amber of New Jersey (Hymenoptera: Apidae: Meliponinae). *American Museum Novitates* 2917: 1-10.
- Michener, C. D. and D. A. Grimaldi. 1988b. The oldest fossil bee: Apoid history, evolutionary stasis, and antiquity of social behavior. *Proceedings of the National Academy of Science USA* 85: 6424-6426.
- Pamilo, P., A. Pekkarinen, and S. Varvio-Aho. 1981. Phylogenetic relationships and the origin of social parasitism in Vespidae and in *Bombus* and *Psithyrus* as revealed by enzyme genes. Pp. 37-48, in P. E. Howse and J. L. Clement (eds.), *Biosystematics of Social Insects*. London: Academic Press.
- Pamilo, P., A. Pekkarinen, and S. Varvio-Aho. 1987. Clustering of bumblebee subgenera based on interspecific genetic relationships (Hymenoptera, Apidae: *Bombus* and *Psithyrus*). *Annals Zoologici Fennici*

- 24: 19–27.
- Pederson, B. V. 1996. A phylogenetic analysis of cuckoo bumblebees (*Psithyrus*, Lepelletier) and bumblebees (*Bombus*, Latreille) inferred from sequences of the mitochondrial gene cytochrome oxidase I. *Molecular Phylogenetics and Evolution* 5: 289–297.
- Pereira-Martins, S. R. and W. E. Kerr. 1991. *Biologia de Eulaema nigrita*. 3. Inferencias evolutivas. *Papéis Avulsos de Zoologia (São Paulo)* 37: 245–250.
- Plant, J. D. and H. F. Paulus. 1987. Comparative morphology of the postmentum of bees (Hymenoptera: Apoidea) with special remarks on the evolution of the lorum. *Zeitschrift für Zoologische Systematik und Evolutionforschung* 25: 81–103.
- Prentice, M. 1991. Morphological analysis of the tribes of Apidae. Pp. 51–69, in D. R. Smith (ed.), *Diversity in the genus Apis*. Oxford: Westview Press.
- Richards, O. W. 1968. The subgeneric divisions of the genus *Bombus* Latreille (Hymenoptera: Apidae). *Bulletin of the British Museum of Natural History (Entomology)* 22: 209–276.
- Rohlf, F. J. and R. R. Sokal. 1995. *Statistical Tables* (Third Edition). New York: W.H. Freeman.
- Roig-Alsina, A. and C. D. Michener. 1993. Studies of the phylogeny and classification of long-tongued bees (Hymenoptera: Apoidea). *University of Kansas Science Bulletin* 55: 123–162.
- Ruttner, F. 1988. *Biogeography and Taxonomy of Honeybees*. Berlin: Springer-Verlag.
- Sakagami, S. F. and Y. Maeta. 1984. Multifemale nests and rudimentary castes in the normally solitary bee *Ceratina japonica* (Hymenoptera: Xylocopinae). *Journal of the Kansas Entomological Society* 57: 639–656.
- Sakagami, S. F. and C. D. Michener. 1987. Tribes of Xylocopinae and origin of the Apidae (Hymenoptera: Apoidea). *Annals of the Entomological Society of America* 80: 439–450.
- Sakai, S., H. Hoshiba, and E. Hoshiba. 1986. Integrated taxonomic information on honey bees. *Proceedings of the 30th International Congress of Apiculture, Nagoya, Japan., Apimondia (1986)*: 134–139.
- Sanderson, M. J. and M. J. Donoghue. 1989. Patterns of variation in levels of homoplasy. *Evolution* 43: 1781–1795.
- Schultz, T. R., R. B. Cocroft, and G. A. Churchill. 1996. The reconstruction of ancestral character states. *Evolution* 50: 504–511.
- Sheppard, W. S. and B. A. McPherson. 1991. Ribosomal DNA diversity in Apidae. Pages 89–102, in D. R. Smith (ed.), *Diversity in the genus Apis*. Oxford: Westview Press.
- Smith, D. R. 1991. *Diversity in the Genus Apis*. Oxford: Westview Press.
- Sokal, R. R. and Rohlf, F. J. 1995. *Biometry* (Third Edition). New York: W. H. Freeman.
- Swofford, D. L. 1991. *PAUP, Phylogenetic Analysis Using Parsimony*, version 3.1. Champaign, Illinois: Illinois Natural History Survey.
- Swofford, D. L. 1997. *PAUP*, Phylogenetic Analysis Using Parsimony*, version 4.0d56 (unpublished test version, used with author's permission). D. L. Swofford, Smithsonian Institution, Washington, DC.
- Swofford, D. L., G. J. Olsen, P. J. Waddell, and D. M. Hillis. 1996. Phylogenetic inference. Pp. 407–514, in D. M. Hillis, C. Moritz, and B. K. Mable (eds.), *Molecular Systematics* (Second Edition). Sunderland, Massachusetts: Sinauer Associates.
- Swofford, D. L., J. L. Thorne, J. Felsenstein, and B. M. Wiegmann. 1996. The topology-dependent permutation test for monophyly does not test for monophyly. *Systematic Biology* 45: 575–579.
- Templeton, A. R. 1983. Phylogenetic inference from restriction endonuclease cleavage site maps with particular reference to the evolution of humans and apes. *Evolution* 37: 221–244.
- Tingek, S., G. Koeniger, and N. Koeniger. 1996. Description of a new cavity nesting species of *Apis* (*Apis nuhuensis* n. sp.) from Sabah, Borneo, with notes on its occurrence and reproductive biology. *Senckenbergiana Biologica* 76: 115–119.
- Trueman, J. 1992. *Data Randomiser*, Version 3. Computer program and documentation. Distributed by J. Trueman, School of Life Sciences, Australian National University, Canberra, Australia.
- Wenzel, J. W. 1997. When is a phylogenetic test good enough? Pp. 31–45, in P. Grandcolas (ed.), *The Origin of Biodiversity in Insects: Phylogenetic Tests of Evolutionary Scenarios*, Mémoire Museum National d'Histoire Naturelle 173.
- Wheeler, W. and D. Gladstein. 1993. *Malign*, Version 1.91. Computer program and documentation, distributed by the authors, American Museum of Natural History, New York.
- Wille, A. 1979. Phylogeny and relationships among the genera and subgenera of the stingless bees (Meliponinae) of the world. *Revista de Biologia Tropical* 28: 41–64.
- Williams, P. H. 1985. A preliminary cladistic investigation of relationships among the bumble bees (Hymenoptera, Apidae). *Systematic Entomology* 10: 239–255.
- Williams, P. H. 1991. The bumble bees of the Kashmir Himalaya (Hymenoptera—Apidae, Bombini). *Bulletin of the British Museum of Natural History (Entomology)* 60: 1–204.
- Willis, L. G., M. L. Winston, and B. M. Honda. 1992. Phylogenetic relationships in the honeybee (*Genus Apis*) as determined by the sequence of the cytochrome oxidase II region of mitochondrial DNA. *Molecular Phylogenetics and Evolution* 1: 169–178.
- Winston, M. L. and C. D. Michener. 1977. Dual origin of highly social behavior among bees. *Proceedings of the National Academy of Science USA* 74: 1135–1137.
- Zeuner, F. E. and F. J. Manning. 1976. A monograph on fossil bees (Hymenoptera: Apoidea). *Bulletin of the British Museum of Natural History (Geology)* 27: 155–268.
- Zrzavy, J. 1997. Phylogenetics and ecology: All characters should be included in the cladistic analysis. *Oikos* 80: 186–192.

APPENDIX 1

Taxa Represented in Phylogenetic Analyses

Outgroups: *Exoneura bicolor* Smith, *Xylocopa virginica* (Linnaeus). Euglossini: *Eulaema polychroma* (Mocsary), *Eufriesia caeruleascens* (Lepelletier). Bombini: *Bombus pennsylvanicus* (De Geer), *Bombus avinoviellus* Skorikov, *Psithyrus variabilis* (Cresson). Meliponini: *Trigona necrophaga* Camargo & Roubik, *Trigona muzoensis* Schwarz, *Scaptotrigona luteipennis* (Friese), *Melipona compressipes* (Fabricius). Note: revised identifications of *T. necrophaga* and *T. muzoensis* (*T. "hypogaea"* and *T. "pallens"* of Cameron, 1991, 1993) are due to D. Roubik (pers. comm.). Apini: *Apis cerana* Fabricius, *Apis koschevnikovi* Buttel-Reepen, *Apis mellifera* Linnaeus, *Apis florea* Fabricius, *Apis dorsata* Fabricius.

Morphological Data Matrix

Taxa	Characters																	
	1	2	3	4	5	6	7	8	9	10	11	12	13	14	15	16	17	18
<i>Exoneura bicolor</i>	0	0	0	0	0	0	0	0	0	0	0	0	0	0	0	0	0	0
<i>Xylocopa virginica</i>	2	0	0	0	0	0	0	0	0	0	0	1	0	1	0	0	0	0
EUGLOSSINI																		
<i>Eulaema polychroma</i>	2	0	0	0	0	0	0	0	0	0	0	0	0	1	1	1	1	1
<i>Eufriesia caeruleascens</i>	2	0	0	0	0	0	0	0	0	0	0	0	0	1	1	1	1	1
BOMBINI																		
<i>Bombus pennsylvanicus</i>	2	0	0	0	1	0	0	0	0	0	1	0	1	1	1	1	1	0
<i>Bombus avinoviellus</i>	2	0	0	0	1	0	0	0	0	0	1	0	1	1	1	1	1	0
<i>Psithyrus variabilis</i>	2	0	0	0	1	0	0	0	0	0	1	0	1	1	1	1	1	0

MELIPONINI

<i>Trigona necrophaga</i>	1110111111	1110000011	11101
<i>Trigona muzuensis</i>	1110111111	1110000011	11101
<i>Scaptotrigona luteipennis</i>	1110111111	1110000011	11101
<i>Melipona compressipes</i>	1110111111	1110000011	11101

APINI

<i>Apis cerana</i>	1111111111	1111110011	11101
<i>Apis koschevnikovi</i>	1111111111	1111110011	11101
<i>Apis mellifera</i>	1111111111	1111110011	11101
<i>Apis florea</i>	1111111111	1111110011	11101
<i>Apis dorsata</i>	1111111111	1111110011	11101

Morphological character descriptions

- 1: Mandibular grooves. (0) Present. (1) Almost or completely absent. (2) Very well developed.
- 2: Hypopharyngeal plate. (0) Sensory lobes elongate. (1) Sensory lobes short, transverse.
- 3: Stipites. (0) Posteriorly produced into a dorsal flange overlapping cardines laterally in repose. (1) Not produced posteriorly as a flange.
- 4: Basistipital process. (0) Normally developed. (1) Reduced.
- 5: "Basigaleal bar". (0) Not differentiated. (1) Differentiated as a distinct process.
- 6: Postmentum. (0) Continuous. (1) Divided into mentum and lorum.
- 7: Prosternal constriction. (0) Absent. (1) Present.
- 8: Prosternal apophyseal pit. (0) Present. (1) Absent.
- 9: Prosternal setae. (0) Present. (1) Absent.
- 10: Basisternum. (0) Normally developed. (1) Enlarged.
- 11: Antero-lateral mesoscutal process. (0) With parascutal carina present. (1) With parascutal carina absent.
- 12: Metapleural ridge. (0) Extending to postero-lateral corner of mesopleuron. (1) Curved before postero-lateral corner of mesopleuron.
- 13: Metatibial spurs. (0) Present. (1) Absent.
- 14: Auricle. (0) Absent. (1) Present.
- 15: Strigilis. (0) Without anterior velum. (1) With anterior velum.
- 16: Stigma. (0) Large. (1) Small.
- 17: Jugal lobe. (0) Present. (1) Reduced or absent.
- 18: Alar papillae. (0) Absent. (1) Present.
- 19: Gonobase. (0) Normally developed. (1) Reduced or absent.
- 20: SVII and SVIII of male. (0) Normally developed. (1) Reduced or absent.
- 21: Cuticle. (0) Even. (1) With very uneven patches of darker cuticle.
- 22: Larval food. (0) Not highly supplemented with pharyngeal gland secretions. (1) Highly supplemented with pharyngeal gland secretions.

- 23: First recurrent vein (1r-m). (0) Longer, oblique, not angulate or moderately so. (1) Short and angulate.
- 24: Arolia. (0) Present. (1) Greatly reduced. (2) Absent.
- 25: Corbicula. (0) Absent. (1) Present.

APPENDIX 2

Maximum Likelihood Kishino-Hasegawa Test (ML K-H)

In order to minimize likelihood differences (and correspondingly misleading hypothesis-test results) due to conflict below the tribal level, it was necessary to generate maximum-likelihood (ML) trees for the ML K-H tests. (We refer the reader to the caveats in the text regarding our use of the ML criterion.) These were constructed as follows: First, the most-parsimonious tree (MPT) for the DNA data (the "DNAMPT," Fig. 3b) was evaluated under eight models involving all combinations of values for the general time-reversible and "HKY85" (Hasegawa et al., 1985) substitution models, rate heterogeneity across sites, and proportion of invariable sites (Swofford et al., 1996). Likelihood-ratio tests of the results (Sokal and Rohlf, 1995) indicated that the most parameter-rich model supplied a significantly better explanation of the data than any of the others ($-\ln$ likelihood = 3009.1184; comparison with competing less-parameter-rich model: $c^2_{11} = 5.3914$; $0.025 < P < 0.01$).

The parameters supplied by this model were then employed in two ML searches with 10 random-addition heuristic-search replicates and TBR branch-swapping: (1) an unconstrained search and (2) a constrained search in which the monophyly of the corbiculate bees and the monophyly of each of the tribes was enforced. Based on the ML K-H test, neither of the resulting trees was significantly better at explaining the data than the DNAMPT ($P = 0.2846$ and $P = 0.2947$, respectively). The tree resulting from the unconstrained search contained questionable features, including a paraphyletic outgroup (caused by (*X. virginica* + Euglossini + Apini) and a paraphyletic *Bombus*; the tree resulting from the constrained search was identical in topology with the DNAMPT at the tribal level, but disagreed in certain features of within-tribe topologies in the Apini and the Meliponini. The latter tree (the ML "minimal constraint" tree) was then evaluated under the eight models described above, with likelihood-ratio tests indicating that the data were best explained by a general time-reversible substitution model assuming gamma-distributed among-site rate variation and no sites invariant ("GTR + G") rather than by the most parameter-rich model ($-\ln$ likelihood = 3002.5343; $c^2_{11} = 3.4364$; $0.05 < P < 0.10$).

The parameters derived from the "minimal constraint" tree and the "GTR + G" model were then fixed in three subsequent ML searches that constrained the monophyly of the corbiculate bees and the tribes and that employed 10 random-addition heuristic-search replicates and TBR branch-swapping as follows: (1) A search in which the tribal-level topology of the morphology tree (Fig. 3a) was constrained, (2) a search in which the monophyly of (Bombini + Meliponini + Apini) was constrained, and (3) a search in which the monophyly of (Apini + Meliponini) was constrained. The resulting trees were compared with the ML "minimal constraint tree" in three ML K-H tests, summarized in Figs. 4b, 5b, and 6b, respectively. The "GTR + G" model was used in all ML K-H tests, with free parameters estimated from the data for the particular topologies.

Una Especie Nueva de *Smeringodynerus* (Hymenoptera: Vespidae: Eumeninae) de México

By

ALICIA RODRIGUEZ-PALAFIX¹

ABSTRACT A new species of *Smeringodynerus* Snelling, *S. byroni* sp. nov. (Hymenoptera: Vespidae: Eumeninae) is described from the states of Jalisco, Morelos and Chiapas, Mexico.

Keywords: Hymenoptera; Vespidae; Eumeninae; *Smeringodynerus*; New species; Solitary wasp; Mexico.

INTRODUCCION

El género *Smeringodynerus* fue creado por Snelling (1975), con base en *Odynerus morelios* de Saussure, que anteriormente había sido colocado en *Euodynerus*. Desde la descripción de Snelling, *Smeringodynerus* era considerado monotípico (Vecht and Carpenter, 1990). En este trabajo se describe una segunda especie.

El género es exclusivamente americano y se caracteriza por presentar cerdas negras sobre el cuerpo. Está estrechamente relacionado con *Cephalodynerus* (Snelling, 1975), del cual puede ser separado por poseer el segundo esternito fuertemente truncado en vista de perfil, por presentar cerdas negras conspicuas en la cabeza y por la ausencia del surco basomedial. Sin embargo, el reconocimiento de *Smeringodynerus* como un género distinto de *Cephalodynerus* es dudoso y su estatus podría cambiar (J. M. Carpenter, comunicación personal).

Los ejemplares de la nueva especie que aquí se describe fueron capturados durante dos años de trabajo de campo en los estados de Morelos y Jalisco y diversas colectas en otros estados de México.

Las colecciones depositarias del material tipo son: Instituto de Biología, Universidad Nacional Autónoma de México (UNAM); Colección de la Estación de Biología Chamela, UNAM (EBCC); Bohart Entomological Museum, Universidad de California en Davis, (UCDC); American Museum of Natural History, Nueva York, (AMNH); Snow Entomological Museum, Universidad de Kansas (SEMC). Acrónimos de acuerdo a Arnett and Samuelson (1986).

AGRADECIMIENTOS

La mayor parte de los ejemplares utilizados fueron colectados como parte del proyecto: "Biodiversidad en Insecta [Odonata, Coleoptera (Cantharoidea, Cerambycidae), Diptera (Syrphidae) e Hymenoptera (Apoidea, Vespidae)] en tres zonas del Pacífico Mexicano", financiado por el CONACyT, convenio 4751N. Ricardo Ayala revisó y hizo sugerencias al manuscrito. El Dr.

James M. Carpenter y un revisor anónimo revisaron e hicieron sugerencias al manuscrito. Machos de *S. morelios* fueron prestados por los Dres. John A. Chemsak y Cheryl Barr, Essig Museum of Entomology, Universidad de California en Berkeley.

Smeringodynerus byroni, sp. nov.

(FIGS. 1, 2, 5, 6, 9, 11, 12, 13, 14)

Descripción del Macho: Longitud: 10.8 mm, ala anterior: 8.2 mm. Integumento en general negro, con marcas amarillas sobre los cóndilos mandibulares, una línea en el margen interno del lóbulo inferior del ojo hasta la emarginación ocular, banda apical en los segmentos abdominales 2 al 6 y el clípeo excepto una mancha central parda; el escapo pardo oscuro, las tibias con una mácula y espinas pardo oscuro; alas ambarinas transparentes con el tercio apical infumado, vena radial rojiza.

Pubescencia: Ocre conspicua, apresada y larga sobre la cabeza y tórax; sobre el clípeo blanquecina, abundante y más larga que el diámetro del ocelo medio; ocre rojiza en tibias y tarsos; ocre pálida en el abdomen.

Puntuación: En general regular y uniforme en todo el cuerpo.

Estructura: Clípeo 1.2 veces más ancho que largo, con una emarginación apical igual que el diámetro del ocelo medio que delimitan dientes romos, con puntuación más fina y más separada que en el resto del cuerpo; el tubérculo interantenal sin puntos; puntuación sobre la frente y vértex separada por menos que un diámetro de un punto y un poco más separada en las genas; ocelos posteriores separados por una distancia similar al doble del diámetro del ocelo y con una ligera depresión latero-posterior. Artejo antenal 13 angosto y con sus lados subparalelos en vista dorsal, sin pelos sobresalientes. Carina pronotal oblicua, ángulos humerales proyectados y agudos; puntuación del pronoto y mesoscuto como en el vértex; paratégula curvada, robusta y con el ápice redondeado; carina propodeal anterior no lamelada, sólo ligeramente

¹ Estación de Biología Chamela, IBUNAM, Apartado Postal 21, San Patricio, Jalisco, 48980 MÉXICO. E-mail: aliciar@ibiologia.unam.mx



Figs. 1-4. 1-*Smeringodynerus byroni* sp. nov, holotipo, vista lateral. 2-*S. byroni* sp. nov, holotipo, vista dorsal de la cabeza y tórax. 3-*S. morelios* vista lateral. 4-*S. morelios* vista dorsal de la cabeza y tórax. Escala = 1 mm.

proyectada en el extremo superior. 1er segmento abdominal muy pequeño, menos de la mitad de la longitud del segundo, el terguito visto de perfil no proyectado en su parte media y con puntos más pequeños y más separados que en el vértex, espaciándose hacia la base y llegando hasta el ápice, margen en vista posterior punteado; 2do. terguito con puntos pequeños, separados por más que el diámetro de un punto, haciéndose más pequeños y espaciados hacia la base y más grandes en el ápice, próximo al margen distal con dos prominencias poco pronunciadas, el margen ligeramente levantado y completamente liso; 2do. esternito uniformemente punteado a partir de la truncación basal, con sólo algunos puntos más grandes en el ápice.

Genitalia: Como se ilustra en las Figs. 11, 12, 13 y 14.

Hembra: Similar al macho, excepto por la longitud del ala anterior que oscila entre 9.6-10.4 mm y por el clipeo que es completamente negro y 1.5 veces más ancho que largo.

Variación.—Algunos machos presentan variación en la coloración: el clipeo desde completamente amarillo con el borde inferior pardo oscuro hasta casi completamente negro; la presencia de una banda apical amarilla en el ápice del 1er. terguito cubriendo todo el margen o sólo parcialmente. Entre los individuos, un macho presenta la pubescencia muy pálida sobre todo el integumento, tornándose en algunos casos plateada.

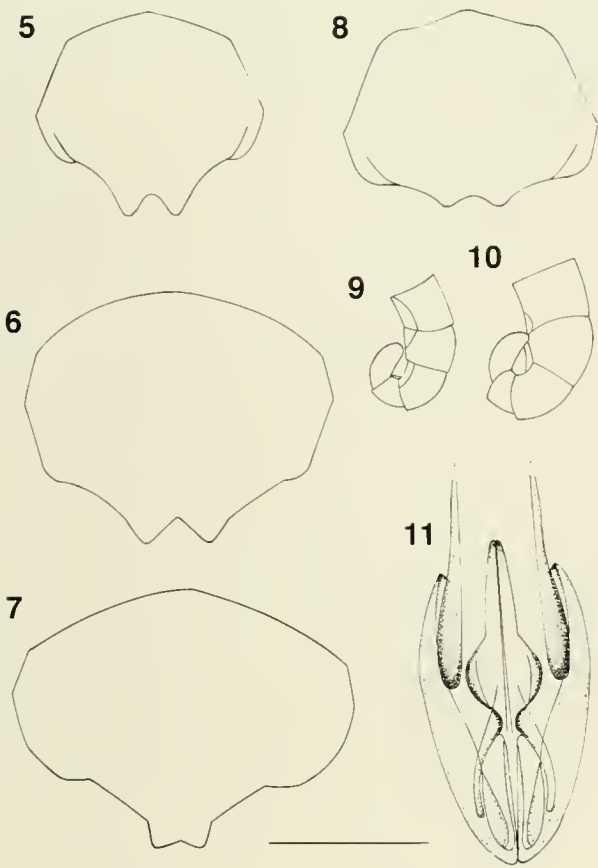

Figs. 5–11. 5, 6, 9 y 11. *Smeringodynerus byroni* sp. nov. 5—clípeo del macho, holotipo. 6—clípeo de la hembra. 9—últimos artejos antenales del macho, holotipo. 11—genitalia del holotipo, vista dorsal, sin pubescencia. 7, 8 y 10. *S. morelios*. 7—clípeo de la hembra. 8—clípeo del macho. 10—últimos artejos antenales del macho. Escala = 1 mm.

Diagnosis.—Esta nueva especie puede ser separada fácilmente de *S. morelios* (Figs. 3, 4, 7, 8, 10) por la puntuación uniforme del vértex y la ausencia de prominencias glabras sobre el vértex; el clípeo fuertemente emarginado; por la pubescencia ocre conspicua en la cabeza y tórax; 1er. segmento abdominal pequeño y menos proyectado en perfil; puntuación uniforme sobre el 2do. esternito y por el patrón de coloración casi completamente negro en contraste con las alas ambarinas transparentes que presentan el tercio apical infumado. Los machos son de menor tamaño que las hembras, la longitud de ala anterior oscila entre 7.8–9.5 mm.

Comentarios.—Esta especie es sólo conocida para México en los estados de Chiapas, Jalisco y Morelos. Fue colectada en áreas con bosque tropical deciduo en un rango de altitud de 720 a 963 m. La mayoría de los individuos

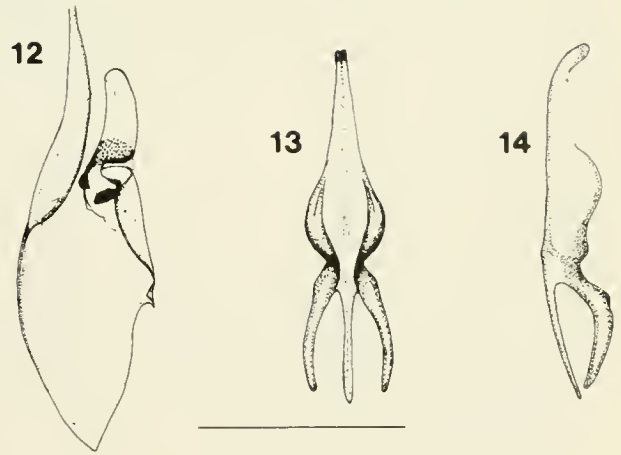

Figs. 12–14. *Smeringodynerus byroni* sp. nov, genitalia del holotipo. 12—vista lateral del parámetro y volsela, sin pubescencia. 13 y 14—vista ventral y lateral del eedeago. Escala = 1 mm.

fueron registrados sobre suelo húmedo y las flores de: *Melampodium* sp. (Asteraceae), *Buddleia sessiliflora* (Berberaceae) y *Vitex mollis* (Vitaceae).

Etimología.—*S. byroni* es dedicado a Byron A. Alexander, destacado himenopterólogo y amigo, como un humilde homenaje póstumo.

Ejemplares Examinados.—*Holotipo macho*: MEXICO: Morelos: 2.5 km O Ajuchitlán, 16–II–1996, Alt. 950 m, 18°28.065'N 98°59.546'O, M. E. Guardado, depositado en UNAM.

Paratipos.—4 machos misma localidad que el holotipo pero con los siguientes datos: 14–III–1996, A. Rodríguez s/41 RA (EBCC); 11–IV–1996, sobre suelo húmedo, M. E. Guardado (AMNH); 11–V–1996, sobre suelo húmedo, B. Rodríguez (UNAM); 6–X–1996, sobre suelo húmedo, M. E. Guardado (UCDC); 4 machos de la siguiente localidad: MEXICO: Morelos, 2.5 km N, 4 km O Huautla, Estación CEAMISH, Alt. 940 m, 18°27.671'N 99°02.475'O con los siguientes datos: 9–VII–1996, sobre suelo húmedo, F. A. Noguera (EBCC); 17–III–1996, R. Ayala s/73RA (EBCC); 8–VIII–1996, sobre suelo húmedo, M. E. Guardado (SEMC); 11–IV–1996, R. Ayala s/73RA (EBCC); 1 macho: MEXICO: Jalisco, 13 km NO Tonaya, 18–VII–1993 Alt. 935m, A. Rodríguez y F. A. Noguera (EBCC); 1 macho: MEXICO: Jalisco, 6.6 km SO San Buenaventura, 4–VI–1997, Alt. 840 m, 19°45.06'N 104°03.55'O, s/suelo húmedo, R. Ayala (EBCC); 3 hembras: misma localidad que el holotipo pero con los siguientes datos: 14–II–1996, sobre suelo húmedo, A. Rodríguez (SEMC); 12–IV–1996, R. Ayala R23 (EBCC); 18–XI–1996, A. Rodríguez (AMNH); 1 hembra: MEXICO: Jalisco, 6.6 km SO San Buenaventura, 10–II–1997, Alt. 840

m, 19°45.06'N 104°03.55'O, suelo húmedo, A. Rodríguez (EBCC); 1 hembra, MEXICO: Jalisco, 4.7 km NE San Buenaventura, 1-V-1997, Alt. 900 m, 19°48.426'N 104°01.882'O, V. H. Toledo (UNAM); 1 hembra: MEXICO: Jalisco, San Buenaventura, 2-VIII-1997, Alt. 720 m, 19°47.61'N 104°03.32'O, Col. A. Rodríguez (UCDC); 1 hembra, MEXICO: Chiapas, 15 km N Tuxtla Gutiérrez, 8-IV-1993, Alt. 963 m, 16°48.36'N 93°06.20'O, A. Rodríguez y F. A. Noguera (EBCC).

LITERATURA CITADA

- Arnett, R. H. and G. A. Samuelson. 1986. *The Insect and Spider Collections of the World*. E. J. Brill/Flora and Fauna Publications, Florida, USA. 304 pp.
- Snelling, R. R. 1975. A new North American genus of Eumenidae (Hymenoptera: Vespoidea). *Proceedings of the Entomological Society of Washington* 77: 56-58.
- Vecht, J. van der and J. M. Carpenter. 1990. A catalogue of the genera of the Vespidae (Hymenoptera). *Zoologische Verhandelingen* 260: 1-62.

Behavior of a Cleptoparasitic Bee, *Triepeolus distinctus* (Hymenoptera: Nomadinae), Before Departing From the Nest of Its Host, *Dieunomia triangulifera* (Hymenoptera: Halictidae)

By

CLARE T. WUELLNER^{1,2} AND MARK S. HIXON³

ABSTRACT The cleptoparasitic bee, *Triepeolus distinctus* (Apidae), is an important natural enemy of the gregarious ground-nesting bee *Dieunomia triangulifera* (Halictidae). A cleptoparasite steals into its host's nest and lays its egg in the host's cell. Before leaving the host's nest, females of *T. distinctus* sit in the nest entrance, slowly moving forward while exhibiting several behaviors, including grooming and previously undescribed behaviors called novel behaviors (i.e., soil-rubbing with the tip of the abdomen and shuffling of the tarsi on the soil). These behaviors are collectively referred to as "pre-departure" behavior. After one female of *T. distinctus* has entered a nest and then exhibited pre-departure behavior, other females that subsequently investigated the entrance of the same nest did not enter it. This suggested that the animals were depositing chemical secretions, possibly used for either marking or host mimicry. To identify chemicals possibly being used for chemical communication, extracts from the Dufour's glands, venom glands, and glandular pouches were analyzed by use of gas chromatography/mass spectrometry techniques (GC/MS). Additionally, Dufour's glands of *D. triangulifera* were analyzed to see if there was chemical overlap with components found in glands of *T. distinctus*. No such overlap in chemical components was found, indicating that chemical mimicry is not occurring.

Keywords: Apoidea; Chemical marking; Chemical masking; Chemical mimicry; Dufour's gland; Glandular pouch; Grooming; Venom gland.

INTRODUCTION

Bees possess exocrine glands that secrete chemicals used for communication. For instance, secretions from the Dufour's glands (alkaline glands) have been shown to be involved in trail-laying within a nest (*Bombus*: Hefetz et al., 1993), nest discrimination for returning females (*Halictus*: Brooks and Cane, 1984; *Eucera*: Shimron et al., 1985), host recognition by bumble bee social parasites (*Psithyrus*: Fisher et al., 1993; and Cederberg, 1983), and possibly kin/nonkin recognition (Hefetz and Graur, 1988; Hefetz et al., 1986; for review see Michener and Smith, 1987). In cleptoparasitic bees specifically, Tengö and Bergström (1976 and 1977) have shown chemical masking, or "perfuming," by bees of the genus *Nomada*. When the male mates with the female, he sprays her with volatile secretions from cephalic glands. The scent he deposits mimics the scent of the host species of bee, presumably facilitating entry into the host nest by the female cleptoparasite. The present study investigates whether a cleptoparasitic species of bees (i.e., bees that lay eggs cuckoo-like in cells of host bees instead of provisioning their own cells) likewise use exocrine glands for chemical communication.

Triepeolus distinctus Cresson, is a nomadine cleptoparasite. The subfamily Nomadinae (Apidae) is composed entirely of cleptoparasitic bees. All cleptoparasitic species have lost behaviors and structures, such as scopae, that are associated with nest-building and provisioning.

The host of *T. distinctus* is the nonsocial halictid bee, *Dieunomia triangulifera* Vachal. Each female maintains her own nest but lives in nesting aggregations. Nests can be as dense as 98/m², and each nest, on average, has 3.4 cells (calculated from data in Minckley et al., 1994). This presents a complex resource patch in which *T. distinctus* must locate suitable cells to parasitize. Additionally, the window of time *T. distinctus* has for laying an egg in a host cell is brief: the cell must be at least partly provisioned, but not yet sealed. Also, the parasite must avoid the host female bee. A nest might be unsuitable because it has no cells at the proper stage for parasitism. Or the nest might have a cell suitable for parasitism already parasitized by another female of *T. distinctus*. If female cleptoparasites investigated every cell in every nest, much time would be wasted. It would be selectively advantageous for females to decrease the amount of time spent examining unsuitable cells, thereby increasing the number of suitable cells that they can visit in a given searching period.

¹ Department of Zoology, University of Texas, Austin, TX 78712. E-mail: ctw@mail.utexas.edu

² Address for correspondence.

³ Department of Chemistry, University of Washington, Seattle, WA 98195-0001. E-mail: mshixon@gibbs.chem.washington.edu

Bees and sphecid wasps are well-known for their ability to memorize locations of nests and food resources. Extensive studies of their orientation behavior have been completed by Tinbergen (1972a, 1972b) and Frisch (1967); for review, see Jander (1997) and Zeil et al. (1996). Bees and wasps are capable of memorizing several locations. Female sphecid wasps (*Ammophila* spp.), for instance, maintain several nests at one time, keeping track of each nest location and whether the offspring therein require additional provisions (Evans, 1965; Baerends, 1941).

Cane (1983) studied visual cues used by female cleptoparasitic bees (*Nomada pseudops*, *N. australis*, and *N. oblitterata*: Apidae; and *Sphecodes persimilis*: Halictidae). He observed orientation behavior as the cleptoparasites left host nests. His findings could lead to the conclusion that females of *Nomada* remember host nests and return to them as new cells are provisioned.

Further, Cane (1983) established that olfactory cues at the hosts' nest entrances were used by the cleptoparasites to determine if nests were suitable. Chemical cues are used by other species of ground-nesting bees to locate nests (see Weislo, 1992 and references therein). The nest entrances might be permeated with individual-specific odors, which the nest owner might recognize. At the field site studied herein, there are tens of thousands of host nests. Memorization by the cleptoparasite of even a small fraction of the locations of nests would be more complex and take more time than simply marking nests with chemical cues.

We studied the components of the cleptoparasite bees' behavior just before departing from the nest, and also the chemical composition of extracts from the abdominal glands of *T. distinctus*. The glands analyzed included: Dufour's glands, venom glands, and glandular pouches. Glandular pouches are common to the reproductive tracts of all known nomadine bees, but are not found in other taxa of bees. These structures, described by Alexander (1996), are lateral evaginations of the oviduct. Alexander suggested several possible functions for these glands, including secretion of chemicals that restore integrity of the host cell lining, antifungal/antibiotic secretions to reduce the cleptoparasite's egg mortality from fungus and/or bacteria, and chemical "masking" of the cleptoparasite's egg so that the host bee is less likely to locate and destroy the foreign egg.

We considered the possibility that secretions of the glandular pouches might mask the cleptoparasite's presence by chemical mimicry of the host at the nest entrance. Chemical mimicry was also hypothesized as a possible function of secretions of two other abdominal glands of *T. distinctus*. To test the chemical mimicry hypothesis, we made a comparison between the chemical composition of Dufour's glands of *D. triangulifera* and the three abdomi-

nal glands of *T. distinctus*. If chemical components of glands from both species overlapped, this would suggest that *T. distinctus* is applying chemicals that mimic chemicals of *D. triangulifera*, thereby masking its recent visit to its host's nest.

ACKNOWLEDGMENTS

This paper is dedicated to Byron Alexander, whose own work inspired the research done herein. Byron was a wonderful friend and mentor. We miss him deeply. We are grateful to Todd Williams of The University of Kansas, Lawrence, Kansas for helping with the gas chromatography-mass spectroscopy analyses and for helpful comments. This research was funded by a P.E.O. Scholars Award (GN Chapter) and a grant from Sigma Xi.

MATERIALS AND METHODS

BEHAVIOR OF *TRIEPEOLUS DISTINCTUS*

During the 1995 and 1996 flight seasons (late Aug through early Sept), CW observed females of *T. distinctus* performing a suite of behaviors, hereafter referred to as pre-departure behavior (see "Results"). Female cleptoparasites visiting nests were monitored for how much time they spent in the host's nest and how much time they spent at the nest entrance performing pre-departure behaviors.

During the 1996 field season, pre-departure behavior of *T. distinctus* was videotaped in the field using a camcorder. From this videotape, an ethogram and a Markov diagram of pre-departure behavior were generated. To generate the Markov diagram, transitions between any of the component behaviors of pre-departure behavior were tallied. Occasionally the bee exhibited two grooming behaviors simultaneously (abdominal and facial/antennal grooming, see "Results" for descriptions of these behaviors). When two behaviors occurred simultaneously, whichever of the two behaviors had been initiated first was scored as the first behavior, and the second behavior to be initiated was scored as the second. All other behaviors were mutually exclusive.

Pre-departure behaviors were of two categories: grooming and novel behaviors. To test the null hypothesis that grooming and novel behaviors were equally likely to occur during the first half of a pre-departure episode versus the second half, a Chi-square contingency test of observed versus expected frequencies of novel behaviors was calculated.

On seven occasions (separate from those occasions for which the pre-departure behavior was videotaped), the host nest was watched after the cleptoparasite departed to record the response of the next cleptoparasite or host bee.

In all instances, the utmost care was taken to reduce observer interference with normal behavior. Shadows were not cast over the bees nor were sudden movements made that might have startled either species of bee. All human movement was kept to a minimum when the bees were being filmed. The zoom lens on the video camera allowed filming at a distance of approx 1 m. The cleptoparasites continued behaviors uninterrupted as long as movement did not startle them. When startled by movement (whether they were in the open or in nest entrances), they abruptly stopped their normal behavior and flew away. They did not retreat into nest entrances or seek other hiding places. No data were used that included any startled behavior.

PREPARATION OF ABDOMINAL GLANDS

Females of both *T. distinctus* and *D. triangulifera* were collected in the field and stored at -80°C for approx 2 months. All dissections were done under distilled water. The Dufour's glands, venom sacs, and glandular pouches of eight *T. distinctus* were collected in Teflon-capped glass vials, and extracted into 80 μl , 60 μl , and 200 μl of pentane, respectively. Dufour's glands of two females of *D. triangulifera* were collected in Teflon-capped glass vials and extracted into 100 μl of pentane. Glandular pouches were not dissected from females of *D. triangulifera* because they do not possess them. Neither were the venom glands of females of *D. triangulifera* dissected and analyzed.

CHEMICAL ANALYSIS

All spectral analyses were performed using a Hewlett Packard 5790 gas chromatograph equipped with a 30 m DB1 (dimethyl polysiloxane)(J and W Scientific, Folsom, CA) capillary column interfaced with a Ribermag R-10-10 quadrupole mass spectrometer (Nermag S.A.) at the Mass Spectrometry Laboratory, The University of Kansas, Lawrence, KS. Sample extracts were run in splitless injection mode (1 μl injection volume). The gas chromatograph oven was programmed with an initial isothermal period of 5 min at 80°C , followed by a temperature ramp of $5^{\circ}\text{C min}^{-1}$ to 260°C and a $25^{\circ}\text{C min}^{-1}$ ramp to 300°C held for 10 min. Total ion chromatograms were compiled from 1.2 second scans at 70 electron volts from 40 to 300 atomic mass units. All spectra were taken from chromatogram peak maxima with background subtraction.

After an initial gas chromatography-mass spectral analysis (GC-MS), 40 μl of 15% *bis* (trimethylsilyl)-trifluoroacetamide (BSTFA) in acetonitrile was added to the extracts. After a 2-hour incubation at room temperature, the samples were reanalyzed. Treatment of the extracts with BSTFA served three purposes. First, volatility was increased, which gave an earlier retention time and greater sensitivity. Second, reaction with BSTFA yielded

easily detectable ions to indicate molecular weights. Lastly, if samples treated with BSTFA were compared to untreated samples, gas chromatograph peaks that do not change have no active hydrogens and therefore are probably hydrocarbons. Peaks that do change can be identified as components that have active hydrogens, such as alcohols, carboxylic acids, thiols, and amines (McCloskey et al., 1968 and references within).

Identification of individual components of interest was made by examining retention time and the ion fragmentation patterns with comparison to a mass spectral library using the mass-spectral matching program Benchtop PBM 3.0 (Palisade Corp., Newfield, NY).

MOLECULAR STANDARDS

Cocktails containing 100 ng/ μl , 10 ng/ μl , and 1 ng/ μl of n-dodecane, n-tetradecane, n-hexadecane, n-octadecane, methyl stearate, n-heptadecanoic acid and 1-undecanol were analyzed by GC-MS for the determination of differences in paraffin retention index and estimates of detection limits. Underivatized (i.e., without BSTFA), the GC-MS was unable to detect n-heptadecanoic acid and 1-undecanol < 100 ng/ μl . The addition of BSTFA permitted their detection as trimethylsilyl (TMS) esters and ethers, respectively.

CHEMICALS

All solvents were HPLC grade or better. All reagents were obtained from Aldrich Chemical Company, except the paraffin standards, which were an N-paraffin mix standard (SN#8383, Alltech Association, Inc., Deerfield, IL).

RESULTS

PRE-DEPARTURE BEHAVIOR

If a female of *T. distinctus* visited a host bee's nest, she usually terminated her visit by spending time in the nest entrance, facing outward, moving gradually forward as she performed what appear to be grooming movements. The range of time spent inside the nest by female cleptoparasites was 14–389 s (Mean = 165.39 s, SD = 97.00, $n = 18$). The range of time spent performing pre-departure behavior was 7–111 s (Mean = 42.61 s, SD = 31.80, $n = 18$). The length of time spent performing these behaviors was correlated positively with the length of time the cleptoparasite had spent in the host's nest ($r = 0.584$, $n = 18$, $P < 0.011$).

The ethogram generated included the same nest-inspecting behaviors that Cane (1983) observed. On the other hand, CW did not observe orientation flights by females of *T. distinctus* following nest visitation, whereas Cane (1983), Linsley and MacSwain (1955), and Eickwort and

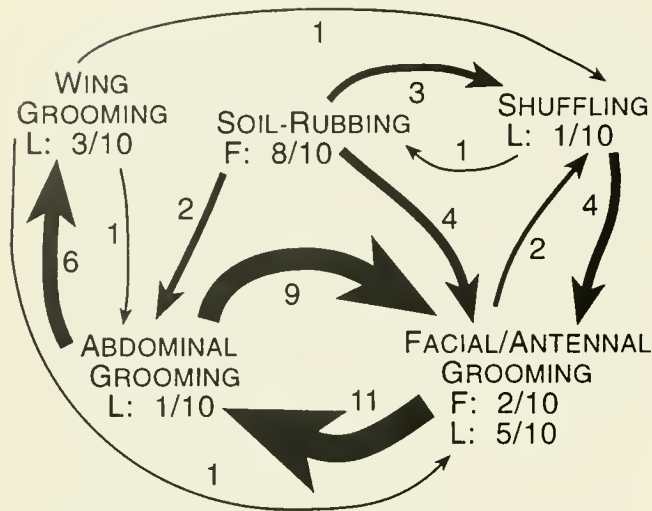

Fig. 1. Markov diagram of the behavioral components of pre-departure behavior, as explained in Table 1. Numbers near the connecting arrows indicate the number of shifts observed during 10 pre-departure episodes. "F" is the number of times this was the first behavior observed in 10 pre-departure episodes. "L" is the number of times this was the last behavior observed in 10 pre-departure episodes.

Abrams (1980) reported such orientation flights for various other cleptoparasitic species of bees. This variance is important because it indicates that this species of cleptoparasitic bee does not use visual cues to memorize the location of a nest. However, CW observed orientation flights in the following scenario: the cleptoparasite inspects the nest, exits, performs an orientation flight, perches within 10 cm of the nest entrance, waits till the nest owner leaves, reorients to relocate the nest entrance, and reenters the nest.

Ten episodes of pre-departure behavior were informative enough to be analyzed. As detailed in Table 1, pre-departure behavior included grooming behaviors (i.e., facial-antennal, abdominal, and wing), and two novel behaviors (i.e., shuffling and soil-rubbing). All behaviors from the time the female cleptoparasite appeared in the nest entrance after visiting a nest until she departed were recorded. As cleptoparasites performed pre-departure behavior, they gradually moved further and further out of the nest entrance. Therefore, for the last few behaviors, the entire cleptoparasite's body was usually visible.

The Markov diagram (Fig. 1) shows each behavioral component of pre-departure behavior and how often there was a transition between behaviors. Additionally, the diagram shows how many times out of ten pre-departure episodes began or ended with each behavior. Novel behaviors were highly likely to occur during the first part of pre-departure behavior ($\chi^2_1 = 9.94, P < 0.0025$). For eight of the ten individuals videotaped, when the female cuckoo

bee was first visible in the nest entrance, the bee's whole body was moving forward and backward; that is, the motion associated with soil-rubbing. The other two individuals were first seen doing facial-antennal grooming. Sometime during the pre-departure episode, nine of the ten individuals videotaped exhibited the forward and backward motion associated with abdominal grooming, and six did shuffling behavior. The behaviors done just prior to departing from the nest entrance included wing grooming ($N = 3$ of 10), abdominal grooming ($N = 1$ of 10), facial-antennal grooming ($N = 5$ of 10), and shuffling ($N = 1$ of 10).

On three of the seven occasions after a pre-departure behavior episode and subsequent departure of the

GROOMING BEHAVIORS	
ABDOMINAL	Tibiae and tarsi of hind legs groom the posterior ventral one-third of the abdomen. The tip of the abdomen is groomed most vigorously. Sometimes the female uses both hind legs simultaneously, sometimes one at a time. No grooming of the thorax, which is executed with the second leg (Jander 1976), was observed.
FACIAL-ANTENNAL	Femora, tibiae, and tarsi of the front legs groom the eyes and antennae.
WING	Tibiae and tarsi of hind legs groom the upper surface of the forewings, which are folded over the dorsal surface of the abdomen. The wing is pulled by the leg to the side of the animal and groomed by repeatedly rubbing the leg back and forth from the base to the tip of the wing. Jander and Jander (1978) describe this wing-cleaning movement in detail.

NOVEL BEHAVIORS	
SHUFFLING	All six tarsi are rubbed on the substrate. All six tarsi are on the ground for this behavior. Front and hind tarsi of one side and middle tarsus of the opposite side move synchronously.
SOIL-RUBBING	The tip of the abdomen is inserted into the soil. This behavior was seen only once because the bee's abdomen usually is not visible when the animal is sitting in the host's nest entrance. However, the forward and backward motion of the animal's body as it performs this behavior is discernible even when only the anterior part the animal is visible.
OTHER BEHAVIORS	
PERCHING	Resting on the ground near a nest entrance, waiting for the host female, <i>Dieunomia triangulifera</i> , to exit her nest.
ORIENTATION	Flight in arcs, facing the nest entrance. The arcs, at first are small and close to the nest entrance. The arcs then become progressively and simultaneously wider, further from the nest entrance, and higher from the ground.

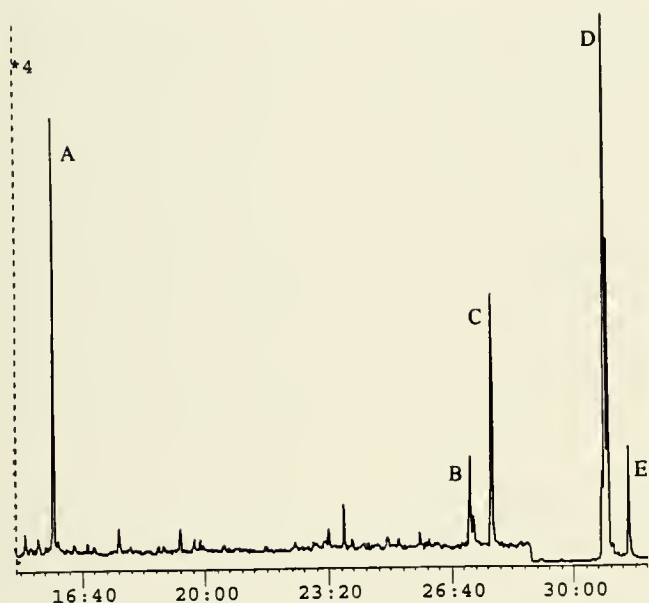

Fig. 2. Chromatogram of the derivatized (with BSTFA) reaction of *Triepolus distinctus* glandular pouches. Peak "A" = unidentified, two active hydrogen groups, two oxygens, and a molecular weight of 259. Peak "B" = C_{16} fatty acid. Peak "C" = a long-chain fatty acid TMS ester. Peak "D" = monounsaturated C_{18} fatty acid TMS ester. Peak "E" = a saturated stearic acid TMS ester. Peaks "A," "B," and "C" are magnified times four.

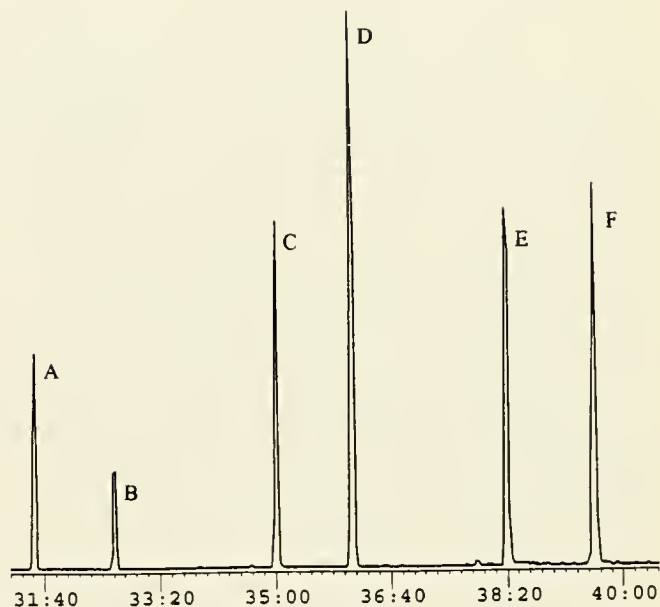

Fig. 3. Chromatogram of the derivatized (with BSTFA) reaction of the Dufour's glands of *Dieunomia triangulifera*. The first series (peaks A, C, and E) = unidentified, no active groups, no aromatics, and highly branched. The second series (peaks B, D, and F) = terminal alkene (center of distribution = C_{38}).

cleptoparasite, a second *T. distinctus* was seen to inspect the nest entrance. In all three instances, the second cleptoparasite briefly inspected the nest entrance but then departed. On the other four occasions females of *D. triangulifera* returned to their recently-visited nests before a second *T. distinctus* inspected the nest entrance. In all four instances, the host bee had no apparent reaction at the nest entrance. The mean time host bees spent inside parasitized nests (Mean = 9.75 min, $SD = 4.53$, $N = 4$) was not significantly different from mean time spent inside nests not known to be parasitized (Mean = 8.21, $SD = 3.32$, $N = 36$; t -test, $t = 3.18$, NS).

CHEMICAL ANALYSIS

Pentane-extractable components were found in all three glands of *T. distinctus*, and in the Dufour's gland of *D. triangulifera*. All three glands in *T. distinctus* had straight-chain hydrocarbon series (center of distribution = C_{34} or C_{36}). This series was the only notable component of the venom glands.

In the underivatized (i.e., without BSTFA) reaction of the glandular pouches of *T. distinctus*, components included two contaminants (phthalate and butylated hydroxytoluene), a straight-chain hydrocarbon series (center of distribution = C_{34} or C_{36}), and a substituted terminal

alkene. The derivatized (i.e., with BSTFA) extract of glandular pouches of *T. distinctus* had five peaks identified as fatty acids (Fig. 2). Fatty acids are not usually encountered in gas chromatography extraction because they do not extract well into non-polar solvents such as pentane. The component at peak "A" had two TMS groups (i.e., had two active hydrogen groups), two oxygens, and a molecular weight of 259. The component at peak "B" was a C_{16} fatty acid. The component at "C" was a long-chain fatty acid TMS ester. The component at "D" was a monounsaturated C_{18} fatty acid TMS ester. The component at "E" was a saturated stearic acid TMS ester.

The Dufour's glands of *T. distinctus* had the series of saturated hydrocarbons (center of distribution = C_{34} or C_{36}) mentioned above. The BSTFA reaction brought out a monounsaturated C_{18} fatty acid.

The Dufour's glands of *D. triangulifera* showed two series in which chromatography was unaltered by treatment with BSTFA, indicating that neither series was comprised of compounds with active hydrogens (Fig. 3). The first chromatographic series (peaks A, C, and E) contained no aromatics, and based on the fragmentation patterns were highly branched hydrocarbons. The second chromatographic series (peaks B, D, and F) was composed of terminal alkenes with a center of distribution at C_{38} .

DISCUSSION

BEHAVIOR

Pre-departure behavior is noteworthy because the cleptoparasite seems to be taking some risk by remaining in the host bee's nest longer than necessary. The risk is not because the female cleptoparasite is in any danger from the host; neither *D. Yanega* (pers. comm.) nor CW have seen any signs of interspecific aggression between *D. triangulifera* and *T. distinctus* when females encounter each other. Rather, the danger potentially could be to the cleptoparasite's egg if the returning host is able to recognize a foreign egg or make the association between the adult cleptoparasite's presence and the possibility that one of her cells has been parasitized. Such associative learning has been observed for wasps (B. Alexander, pers. comm.). Why, then, would the cleptoparasite potentially reduce her own fitness by remaining in the nest entrance where she could be seen and/or attacked?

Pre-departure episodes included grooming behaviors previously reported (Jander, 1976; Jander and Jander, 1978) and two novel behaviors (shuffling and soil-rubbing) not reported previously. These novel behaviors could have two possible functions. The most parsimonious explanation is that these are also grooming behaviors. Although Jander (1976) did include a representative *Triepeolus* in his study of grooming behavior, he did not study grooming behavior in a completely natural setting. Therefore, these novel behaviors might be grooming behaviors specifically associated with host nest visitation. Use of the substrate in grooming has been reported, but only for grooming antennae (e.g., Jander, 1966).

A second possible explanation is that the novel behaviors are used to deposit chemicals at the nest entrance. These behaviors resemble chemical-depositing movements described for other hymenopterans (see below), and it would not be difficult to see how chemical-depositing behaviors could evolve from this complex set of grooming-like movements. The fact that the novel behaviors are followed by grooming behaviors is congruous with findings that grooming behavior is often used as a displacement behavior when an animal is making a transition from one activity to another (Pfumm, 1983; Jiersel and Bol, 1958; Tinbergen, 1952). In this instance, grooming might be a transition behavior between marking the nest and leaving the nest.

CHEMICAL ANALYSIS

The GC/MS analyses of the three glands of *T. distinctus* and the Dufour's glands of *D. triangulifera* give some insight into the chemical composition and possible functions of these gland products. No volatile chemicals likely to be used as pheromones were detected in the products of the

glandular pouches. The ultrastructure of the glandular pouches most resemble secretory cells (Cutler and Alexander, this volume). Given the location of the glandular pouches in the reproductive tract and the components identified, it is more likely that the glandular pouches are involved in egg laying, protection of the eggs from desiccation after oviposition, or closing the lining of the host cell after insertion of the egg in the cell wall. The fatty acids found, especially the C₁₆ and C₁₈ acids, are important precursor molecules for chemicals that could serve hydrophobic and/or adhesive functions. Because no components of the glandular pouches of *T. distinctus* overlap with the components found in the Dufour's gland of *D. triangulifera*, it is unlikely that the glandular pouches produce "masking" chemicals, as suggested by Alexander (1996).

None of the components found in the Dufour's glands or in the venom glands of *T. distinctus* overlapped with those of *D. triangulifera*. Had the components overlapped, this could have suggested a chemical mimicry function. Females of *D. triangulifera* returning to their nests that had been visited by cleptoparasites did not show signs of recognition of the visit. If *T. distinctus* is leaving chemicals at the nest entrance during the pre-departure episode, the chemicals could function in intraspecific marking. Although the sample size of second visitations by female cleptoparasites is small, the reactions of the second visitors suggest that a previously attractive nest after visitation and a pre-departure episode by the first cleptoparasite was unattractive. This suggests that the cleptoparasite was marking the nest entrance. A chemical cue left at parasitized nests would serve to prevent revisitation of the same nest twice, thus avoiding wasted time and energy.

CHEMICAL MARKING

Marking chemicals deposited by cleptoparasites undoubtedly evolved as cues that individuals recognized and used to avoid parasitizing the same resource twice. Such a signal, which was obvious to and recognized by the marking individual, might also be obvious to and recognized by con- and heterospecifics. Whether the recognized chemical is repellent or attractive seems to depend on the system. Cane (1983) found that recently parasitized host nests were more attractive than unparasitized nests to other cleptoparasites. He found that chemical cues left by the first successful female of *Nomada* drew the attention of subsequent cleptoparasites (Cane 1983). Linsley and MacSwain (1955) found that some host cells contained two or more eggs of *Nomada*. Perhaps in the systems studied by Cane (1983) and Linsley and MacSwain (1955), a second cleptoparasite had a reasonable chance of destroying the egg of the first.

A repellent effect has been shown in other studies. Indeed, marking as a means of avoiding superparasitism has been suggested for other Hymenoptera (e.g. Salt, 1935; Guillot and Vinson, 1972). Marking either the host or surrounding substrate has been reported for ichneumonids and braconids. Studies have shown that marking chemicals serve as markers to which the same individual (Hefetz, 1987; 1990), conspecifics (Vinson, 1972), and even other species of natural enemies respond (Price, 1970; 1972). Braconid parasitoids can distinguish between parasitized and unparasitized hosts and tend to avoid hosts that have been parasitized. The behavioral data presented herein suggest that females of *T. distinctus* also avoid recently-parasitized nests. Therefore, marking might serve as a signal allowing avoidance of superparasitism for *T. distinctus*.

Parasitic Hymenoptera can apply marking chemicals either via the ovipositor, by inserting the tip of the abdomen into the substrate, or by dragging the end of the abdomen over the substrate. Substrate-marking seems less common than host-marking. For some species of ichneumonids, secretions from Dufour's glands have been demonstrated to be the source of marking chemicals (e.g., Guillot and Vinson, 1972), although simply walking over the substrate is a sufficient marker for some ichneumonids (Price, 1970). No ichneumonid or braconid wasp is known to use orientation behavior. For nomadine bees, only orientation has been reported previously as a possible method of avoiding revisiting a nest. If chemical cues are being used to avoid nest revisitation, then observation of responses by conspecifics to chemical extracts should yield important results.

LITERATURE CITED

- Alexander, B. A. 1996. Comparative morphology of the female reproductive system of nomadine bees (Hymenoptera: Apidae: Nomadinae). *Memoirs of the Entomological Society of Washington* 17: 14-35.
- Baerends, G. P. 1941. Fortpflanzungsverhalten und Orientierung der Grabwespe *Ammophila campestris* Jur., *Tijdschrift voor Entomologie* 84: 68-275. [German]
- Brooks, R. W., and Cane, J. H. 1984. Origin and chemistry of the secreted nest entrance lining of *Halictus hesperus* (Hymenoptera: Apoidea). *Journal of the Kansas Entomological Society* 57: 161-165.
- Cane, J. H. 1983. Olfactory evaluation of *Andrena* host nest suitability by kleptoparasitic *Nomada* bees (Hymenoptera: Apoidea). *Animal Behaviour* 31: 138-144.
- Cederberg, B. 1983. The role of trail pheromones in host selection by *Psithyrus rupiestris* (Hymenoptera, Apidae). *Annales Entomologici Fennici* 49: 11-16.
- Cutler, B. and B.A. Alexander. The ultrastructure of the wall and lining epithelium of glandular pouches in nomadine bees (Hymenoptera: Apidae: Nomadinae). *Scientific Papers*. This volume.
- Eickwort, G. C. and J. Abrams. 1980. Parasitism of sweat bees in the genus *Agapostemon* by cuckoo bees in the genus *Nomada* (Hymenoptera: Halictidae, Anthophoridae). *Pan-Pacific Entomologist* 56: 144-152.
- Evans, H. E. 1965. Simultaneous care of more than one nest by *Ammophila azteca* Cameron (Hymenoptera, Sphecidae). *Psyche* 72: 8-23.
- Frisch, K. von. 1967. *The Dance Language and Orientation of Bees*. Cambridge: Harvard University Press. xiv + 566 pp.
- Guillot, F. S. and S. B. Vinson. 1972. Sources of substances which elicit a behavioural response from the insect parasitoid, *Campoletis perdinctus*. *Nature* 235: 169-170.
- Hefetz, A. 1987. The role of Dufours gland secretions in bees. *Physiological Entomology* 12: 243-253.
- Hefetz, A. 1990. Individual badges and specific messages in multicomponent pheromones of bees (Hymenoptera, Apidae). *Entomologia Generalis* 15: 103-113.
- Hefetz, A. and D. Graur. 1988. The significance of multicomponent pheromones in denoting specific compositions. *Biochemical Systematics and Ecology* 16: 557-566.
- Hefetz, A., G. Bergstrom, and J. Tengö. 1986. Species, individual and kin specific blends in Dufour's gland secretions of halictine bees: chemical evidence. *Journal of Chemical Ecology* 12: 197-208.
- Hefetz, A., J. Tengö, G. Lubke, and W. Francke. 1993. Inter-colonial and intra-colonial variation in Dufour's gland secretion in the bumble bee species *Bombus hypnorum* (Hymenoptera: Apidae). Pp. 469-480, in Weise, K., F.G. Gribakin, A.V. Popov, G. Renninger, (eds.), *Sensory Systems of Anthropods*. Boston: Birkhauser Verlag.
- Jander, R. 1976. Grooming and pollen manipulation in bees (Apoidea): the nature and evolution of movements involving the foreleg. *Physiological Entomology* 1: 179-194.
- Jander, R. 1997. Macroevolution of a fixed action pattern for learning: the exploration flights of bees and wasps. Pp. 79-99, in G. Greenberg and E. Tobach, (eds.), *Comparative Psychology of Invertebrates: The Field and Laboratory Study of Insect Behavior*. New York: Garland Publishing, Inc.
- Jander, R. and U. Jander. 1978. Wing grooming in bees (Apoidea) and the evolution of wing grooming in insects. *Journal of the Kansas Entomological Society* 51: 653-665.
- Jander, U. 1966. Untersuchungen zur Stammesgeschichte von Putzbewegungen von Tracheaten. *Zeitschrift für Tierpsychologie* 23: 799-844.
- Jiersel, J. J. and A. C. A. von Bol. 1958. Preening of two tern species: a study on displacement behaviour. *Behaviour* 13: 1-88.
- Linsley, E. G. and J. L. MacSwain. 1955. The habits of *Nomada opacella* Timberlake with notes on other species (Hymenoptera: Anthophoridae). *Wasmann Journal of Biology* 13: 253-276.
- McCloskey, J. A., R. N. Stillwell, A. M. Lawson. 1968. Use of deuterium-labeled trimethylsilyl derivatives in mass spectrometry. *Analytical Chemistry* 40: 233-236.
- Michener, C. D. and B. H. Smith. 1987. Kin recognition in primitively eusocial insects. Pp. 209-242, in D.J.C. Fletcher and C.D. Michener, (eds.), *Kin Recognition in Animals*. NY: John Wiley & Sons, Ltd.
- Minckley, R. L., W. T. Wcislo, D. Yanega, and S. L. Buchmann. 1994. Behavior and phenology of a specialist bee (*Dieunomia*) and sunflower (*Helianthus*) pollen availability. *Ecology* 75: 1406-1419.
- Pfumm, W. 1983. Zum Sammel- und Putzverhalten der Honigbiene auf einer blühenden Zwergmispel (*Cotoneaster horizontalis*). *Behaviour* 83: 112-131. [German]
- Price, P. W. 1970. Trail odours: Recognition by insects parasitic in cocoons. *Science* 170: 546-547.
- Price, P. W. 1972. Behaviour of the parasitoid *Pleolophus indistinctus*. *Annals of the Entomological Society of America* 63: 1502-1509.
- Salt, G. 1935. Experimental studies in insect parasitism. III. Host selection. *Proceedings of the Royal Society of London (B)* 117: 413-435.
- Shimron, O., A. Hefetz and J. Tengö. 1985. Structural and communicative functions of Dufour's gland secretion in *Encera palestinae* (Hymenoptera: Anthophoridae). *Insect Biochemistry* 15: 635-638.
- Tengö, J. and G. Bergström. 1976. Odor correspondence between *Melitta* females and males of their nest parasite *Nomada flavopicta* K. (Hymenoptera: Apoidea). *Journal of Chemical Ecology* 2: 57-65.

- Tengö, J. and G. Bergström. 1977. Cleptoparasitism and odor mimetism in bees: do *Nomada* males imitate the odor of *Andrena* females? *Science* 196: 1117-1119.
- Tinbergen, N. 1952. Derived activities: their causation, biological significance, origin and emancipation during evolution. *Quarterly Review of Biology* 27: 1-32.
- Tinbergen, N. 1972a. The homing of *Philanthus triangulum*. Pp. 103-127, in N. Tinbergen, *The Animal in its World: Explorations of an Ethologist*. Vol. 1: Field Studies. Cambridge, Massachusetts: Harvard University Press.
- Tinbergen, N. 1972b. Landmark preference by homing *Philanthus*. Pp. 146-196, in N. Tinbergen, *The Animal in its World: Explorations of an Ethologist*. Vol. 1: Field Studies. Cambridge, Massachusetts: Harvard University Press.
- Vinson, S. B. 1972. Competition and host discrimination between two species of tobacco budworm parasitoids. *Annals of the Entomological Society of America* 65: 229-236.
- Wcislo, W. T. 1992. Attraction and learning in mate-finding by solitary bees, *Lasioglossum (Dialictus) figueresi* Wcislo and *Nomia triangulifera* Vachal (Hymenoptera: Halictidae), in relation to sociality. *Ethology* 92: 108-123.
- Zeil, J., A. Kelber, and R. Voss. 1996. Structure and function of learning flights in bees and wasps. *The Journal of Experimental Biology* 199: 245-252.

Description of Preimaginal Instars of Four Species of Elampini, with Some Notes on the Phylogenetic Importance of Larval Characters in this Tribe (Hymenoptera: Chrysididae)

By

JOSÉ TORMOS¹, KARL V. KROMBEIN², JOSEP D. ASÍS¹, AND SEVERIANO F. GAYUBO¹

ABSTRACT The mature larvae of four species of Elampini: *Hedychridium solierellae* Bohart and Brumley, 1967, *Omalus aeneus* (Fabr., 1787), *Philoctetes intermedius* (Aaron, 1885), and *Pseudolopyga taylori* (Bodenstein, 1939), are described. These larvae (in the case of *Philoctetes* Abeille and *Pseudolopyga* Krombein are postdefecating larvae [prepupae]) exhibit the two autapomorphies that would define the tribe Elampini: antennal papillae well developed and few and protuberant marginal sensilla on labrum. *Pseudolopyga* Krombein is characterized by a labium without setae, and *Hedychridium* Abeille by its labial palpi with 4 apical sensilla. *Omalus* Panzer, *Pseudomalus* Ashmead, and *Philoctetes* Abeille cannot be differentiated on the basis of their larval morphology, suggesting a greater phylogenetic proximity among them, as postulated by Kimsey and Bohart (1990) in their analysis of imaginal morphology.

Keywords: Chrysididae; Chrysidinae; Elampini; Preimaginal instars; Parasitic Hymenoptera.

INTRODUCTION

The preimaginal stages of the family Chrysididae, which includes approximately 3000 species (Kimsey and Bohart, 1990), are very little known (Asís et al., 1994; Tormos et al., 1996, 1997). In the tribe Elampini, the mature larvae of only 4 species (3 palearctic and 1 holarctic) have been adequately described: *Hedychridium elegantulum* Buysson, 1887 (Tormos et al., 1997), *Hedychrum rutilans* Dahlbom, 1854 (Maneval, 1936), *Omalus biaccinctus* (Buysson, 1893) (Tormos et al., 1996) and *Pseudomalus auratus* (L., 1758) (Enslin, 1929; Soika, 1934). Short descriptions of the mature larva of *Omalus aeneus* (Fabr., 1787) and of the first larval stages of *Hedychridium solierellae* (Bohart and Brumley, 1967) and *Pseudolopyga taylori* (Bodenstein, 1939) have been offered by Evans (1987) and Carrillo and Caltagirone (1970), respectively. Also, Grandi (1959) described the "larva I" of *Pseudomalus auratus*.

In this paper, descriptions of the mature larvae of 4 species (1 holarctic and 3 nearctic) are offered: *Hedychridium solierellae*, *Omalus aeneus*, *Philoctetes intermedius* (Aaron, 1885), and *Pseudolopyga taylori*; also the phylogenetic value of preimaginal characters is discussed.

The methodology used in the preparation of larval specimens, as well as terminology and organization employed in the descriptions, are similar to those employed by Evans (1987). The material belongs to the Smithsonian Institution collection (Washington D.C.).

ACKNOWLEDGMENTS

Financial support for this paper was provided from the Junta de Castilla y León, project SA 18/96.

We would like to dedicate this paper to the memory of Byron A. Alexander, who made important contributions to the knowledge of systematics and natural history of aculeate wasps. His sudden death has been a tragic loss for all entomologists, and particularly for his friends around the world and for those researchers working on Hymenoptera.

DESCRIPTIONS

Hedychrydium solierellae
Bohart and Brumley, 1967

Carrillo and Caltagirone (1970) reared this chrysidid from nests of the sphecoid wasps *Solierella peckhami* (Ashmead, 1897) and *S. blaisdelli* (Bridwell, 1920), also describing its cocoon.

Our description is based on five mature larvae obtained from trap nests in *Sambucus* at Antioch and Arbuckle, California, in 1966 (Smithsonian Institution collection); the absolute measurements refer to one of those specimens.

General aspect.—Body (length 2.1 mm, width 1 mm) robust; abdominal segments not divided into annulets. Anus terminal, a transverse slit. Pleural lobes developed.

¹ Unidad de Zoología, Facultad de Biología, Universidad de Salamanca, E-37071 Salamanca, SPAIN. E-mail: tormos@gugu.usal.es

² Department of Entomology, National Museum of Natural History, Smithsonian Institution, Washington, DC 20560.

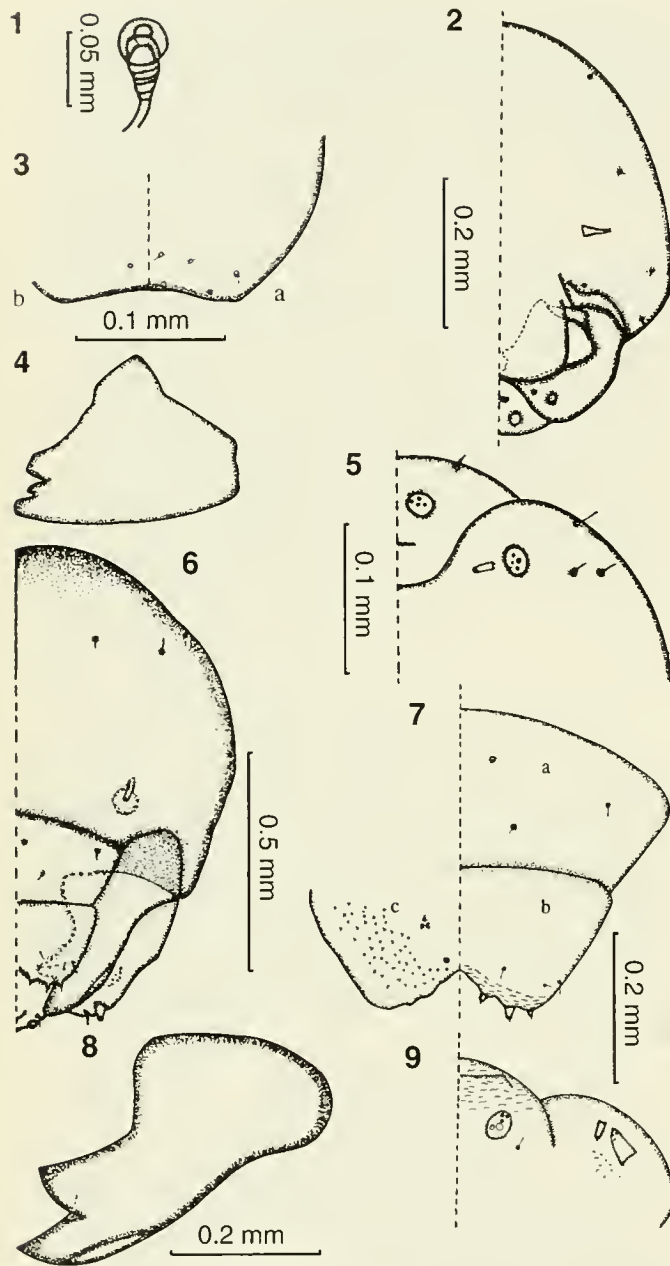

Figs. 1-9. 1-5. Mature larva of *Hedychridium solierellae* Bohart and Brumley. 1-spiracle. 2-cranium (frontal view). 3-labrum (a) and epipharynx (b). 4-mandible. 5-maxillae and labium. 6-9. Mature larva of *Omalus aeneus* (Fabr.) 6-cranium (frontal view). 7-clypeus (a), labrum (b) and epipharynx (c). 8-mandible. 9-maxillae and labium.

Integument with abundant scattered setae ($l = 18 \mu\text{m}$). Spiracles (Fig. 1) (mean diameter $36 \mu\text{m}$, range $34\text{--}40 \mu\text{m}$, $n = 18$) with peritreme; atrium and opening into subatrium simple, naked.

Cranium.—(Fig. 2) ($w = 500 \mu\text{m}$, high $= 300 \mu\text{m}$) with few setae ($l = 8 \mu\text{m}$) and scattered sensilla ($w = 3 \mu\text{m}$). Coronal suture present and parietal bands absent. Antennal

orbits (diam. $38 \mu\text{m}$) inconspicuous; antennal papilla long ($l = 46 \mu\text{m}$, $w = 17 \mu\text{m}$), located slightly below middle of cranium, with three small sensilla on apex. Labrum (Fig. 3a) ($w = 280 \mu\text{m}$, $h = 135 \mu\text{m}$) slightly emarginate, with 4 marginal sensilla ($w = 5 \mu\text{m}$) and 6 medial setae ($l = 12 \mu\text{m}$). Epipharynx (Fig. 3b) with 2 medio-apical sensilla (diam. $3 \mu\text{m}$).

Mouthparts.—Mandibles (Fig. 4) ($l = 185 \mu\text{m}$, $w = 135 \mu\text{m}$) tridentate. Maxillae (Fig. 5) ($l = 235 \mu\text{m}$, $w = 150 \mu\text{m}$) with 3 setae ($l = 22 \mu\text{m}$) on external part. Maxillary palpi (diam. $22 \mu\text{m}$) with 5 sensilla (diam. $5 \mu\text{m}$) at center; galeae ($l = 18 \mu\text{m}$, $w = 7 \mu\text{m}$) long. Labium (Fig. 5) ($w = 145 \mu\text{m}$) with 2 setae ($l = 14 \mu\text{m}$) behind palpi; palpi short (diam. $22 \mu\text{m}$), with 4 sensilla (diam. $5 \mu\text{m}$) at center; spinneret a transverse slit ($l = 72 \mu\text{m}$).

Omalus aeneus (Fabr., 1787)

The description is based on one mature larva, obtained from a nest of the sphecid wasp *Passaloecus cuspidatus* Smith, 1856 (Krombein, 1967) at Derby, New York, in 1957 (Smithsonian Institution collection). Krombein (1967) described the cocoon of this species.

General aspect.—Body (length $= 4.8 \text{ mm}$, width $= 1.9 \text{ mm}$) robust. Segments not humped, the abdominal ones not divided into annulets. Anus terminal, a transverse slit. Pleural lobes developed. Integument microspinulose ($l = 4 \mu\text{m}$), with sparse setae ($l = 11 \mu\text{m}$). Spiracles (mean diameter $49 \mu\text{m}$, $n = 16$) with peritreme; atrium simple, opening into subatrium naked.

Cranium.—(Fig. 6) (width 1.05 mm , height $620 \mu\text{m}$) With sparse setae ($l = 10 \mu\text{m}$). Coronal suture present; parietal bands absent. Antennal orbits (diam. $59 \mu\text{m}$) circular, located below middle of cranium; antennal papilla long ($l = 39 \mu\text{m}$, $w = 14 \mu\text{m}$), with three small sensilla at apex. Clypeus (Fig. 7a) with 4 setae ($l = 15 \mu\text{m}$) and 2 sensilla ($w = 10 \mu\text{m}$). Labrum (Fig. 7b) ($w = 450 \mu\text{m}$) emarginate, with 6 setae ($l = 19 \mu\text{m}$) and 6 protuberant, marginal sensilla ($l = 22 \mu\text{m}$, $w = 19 \mu\text{m}$). Epipharynx (Fig. 7c) spinulose, with 8 sensilla ($w = 2 \mu\text{m}$).

Mouthparts.—Mandibles (Fig. 8) ($l = 456 \mu\text{m}$, $w = 200 \mu\text{m}$) bidentate. Maxillae (Fig. 9) ($l = 223 \mu\text{m}$, $w = 155 \mu\text{m}$) papillose in mesal region. Maxillary palpi ($l = 39 \mu\text{m}$, $w = 29 \mu\text{m}$) longer than wide, with 4 sensilla on apex; galeae ($l = 29 \mu\text{m}$, $w = 10 \mu\text{m}$) well developed, with 1 apical sensillum ($l = 4 \mu\text{m}$). Labium (Fig. 9) ($w = 190 \mu\text{m}$) with sclerotized margins, with 2 setae ($l = 19 \mu\text{m}$) on each side of palpi; palpi short ($l = 19 \mu\text{m}$, $w = 26 \mu\text{m}$) with 5 sensilla on apex; spinneret a transverse slit ($l = 85 \mu\text{m}$).

Philoctetes intermedius (Aaron, 1885)

The description is based on one prepupa, obtained from an aggregation of nests of the ground-nesting sphecid

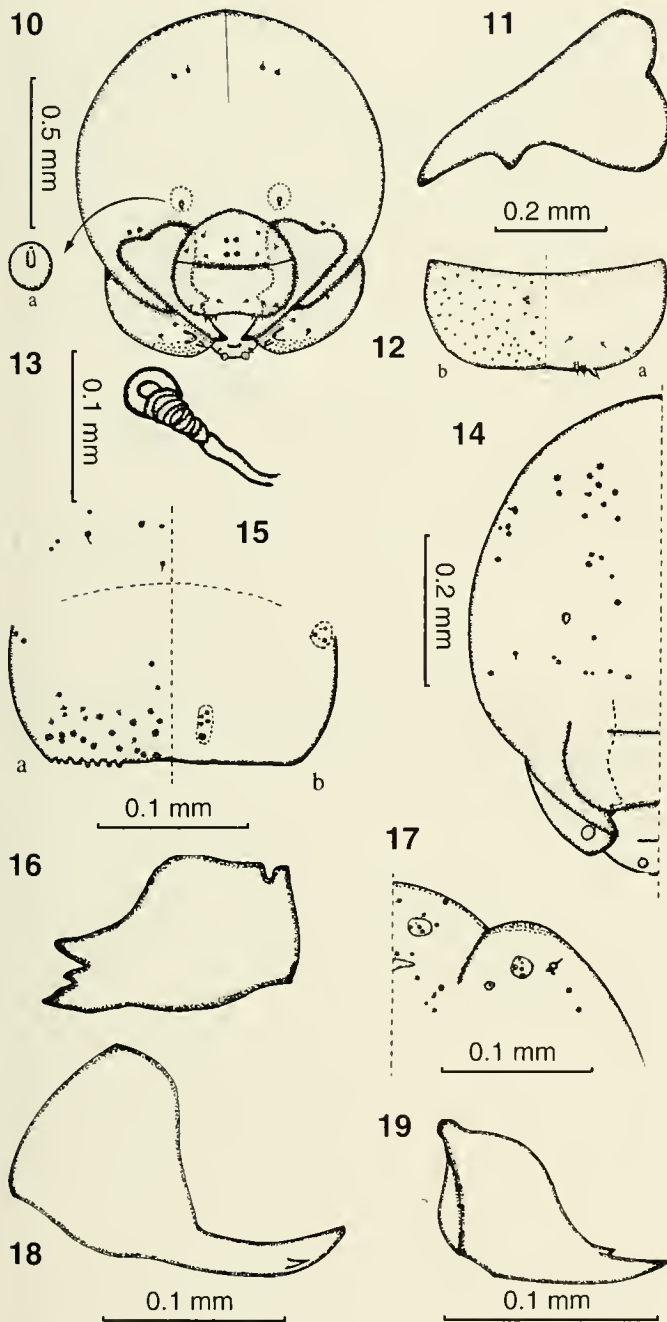

Figs. 10–19. 10–12. Prepupa of *Philoctetes intermedius* (Aaron). 10—cranium (frontal view) and antennal orbit and papilla (a). 11—mandible. 12—labrum (a) and epipharynx (b). 13–19. Mature larva and first and second instar of *Pseudolopyga taylori* (Bodenstein). 13—spiracle. 14—cranium (frontal view). 15—labrum (a) and epipharynx (b). 16—mandible. 17—maxillae and labium. 18—mandible first instar. 19—mandible second instar.

wasp *Diodontus virginianus* (Rohwer, 1917) (Krombein, 1963) from Plummers Island, Maryland, in 1963 (Smithsonian Institution collection). Krombein (1963) described the cocoon of this species.

General aspect.—Body (length 4.5 mm, width 1.7 mm) robust; abdominal segments not divided into annulets. Anus terminal, a transverse slit. Pleural lobes developed. Integument microspinulose ($l = 4 \mu\text{m}$), with sparse setae ($l = 19 \mu\text{m}$). Spiracles (mean diameter $38 \mu\text{m}$, $n = 16$) with peritreme; atrium and subatrium naked.

Cranium.—(Fig. 10) (width 1.1 mm, height $730 \mu\text{m}$) with few setae ($l = 15 \mu\text{m}$) and sensilla (diam. $8 \mu\text{m}$). Coronial suture present and parietal bands absent. Antennal orbits (diam. $38 \mu\text{m}$) circular, located below middle of cranium; antennal papilla (Fig. 10a) ($l = 30 \mu\text{m}$, $w = 15 \mu\text{m}$) long, with three small sensilla ($l = 4 \mu\text{m}$) at apex. Clypeus with 6 setae ($l = 11 \mu\text{m}$) and 4 sensilla ($w = 8 \mu\text{m}$). Labrum (Fig. 12a) ($w = 437 \mu\text{m}$, $h = 152 \mu\text{m}$) slightly emarginate, with 6 setae ($l = 15 \mu\text{m}$) and 6 protuberant, marginal sensilla ($l = 23 \mu\text{m}$, $w = 19 \mu\text{m}$). Epipharynx (Fig. 12b) spinulose, with 8 sensilla ($w = 4 \mu\text{m}$).

Mouthparts.—Mandibles (Fig. 11) ($l = 482 \mu\text{m}$, $w = 228 \mu\text{m}$) completely sclerotized, bidentate. Maxillae (Fig. 10) ($l = 485 \mu\text{m}$, $w = 195 \mu\text{m}$) with apex papillose. Maxillary palpi ($l = 48 \mu\text{m}$, $w = 39 \mu\text{m}$) longer than wide, with 4 sensilla (diam. $9 \mu\text{m}$); galeae ($l = 39 \mu\text{m}$, $w = 20 \mu\text{m}$) well developed, with 1 apical sensillum ($l = 4 \mu\text{m}$). Labium (Fig. 10) ($w = 230 \mu\text{m}$) with 2 setae ($l = 8 \mu\text{m}$) on each side of palpi; palpi short ($l = 40 \mu\text{m}$, $w = 38 \mu\text{m}$) with 5 sensilla ($w = 9 \mu\text{m}$); spinneret a transverse slit ($l = 75 \mu\text{m}$).

Pseudolopyga taylori (Bodenstein, 1939)

Carrillo and Caltagirone (1970) reared this chrysidid from nests of the sphecoid wasps *Solierella peckhami* (Ashmead) and *S. blaisdelli* (Bridwell).

FIRST INSTAR

The description is based on six specimens, obtained at Albany, California, in 1966 (Smithsonian Institution collection); the absolute measurements refer to one of those specimens. The description agrees with that offered by Carrillo and Caltagirone (1970), to which the following aspects should be added:

General aspect.—Integument with tiny spinules. Spiracles small (diam. of atrium $8 \mu\text{m}$), probably not functional.

Cranium.—With placoid sensilla (3–4) on pleurostomial area. Antennal orbits (diam. $31\text{--}40 \mu\text{m}$) circular, located below middle of cranium; antennal papilla ($l = 10\text{--}15 \mu\text{m}$, diam. $10\text{--}15 \mu\text{m}$) with three sensilla on apex. Labrum slightly bilobate, with punctations (probably corresponding to sensilla) on its surface.

Mouthparts.—Mandibles (Fig. 18) ($l = 162\text{--}190 \mu\text{m}$, $w = 85\text{--}90 \mu\text{m}$) unidentate, with a spine on external apical margin. Maxillae without palpi, although where these

should appear there are 5 sensilla arranged directly over the surface. Labium without palpi, although as in the case of the maxillae, the place where they should be is occupied by a group of 5 sensilla.

SECOND INSTAR

The description is based on six specimens obtained at Albany, California, in 1966 (Smithsonian Institution collection); the absolute measurements refer to one of those specimens. The following should be added to the description offered by Carrillo and Caltagirone (1970):

General aspect.—Body ($l = 2.25$ mm, $w = 0.69$ mm). Integument with tiny spinules. Spiracles (diam. of atrium $18\text{--}20$ μm).

Cranium.—Antennal papilla ($l = 17$ μm , $w = 10$ μm).

Mouthparts.—Mandibles (Fig. 19) ($l = 105$ μm , $w = 65$ μm) bidentate.

PREPUA

The description is based on nine specimens obtained from trap nests in *Sambucus*, at Arbuckle, California, in 1966 (Smithsonian Institution collection); the absolute measurements refer to one of those specimens.

General aspect.—Body (length 1.1 mm, width 0.8 mm) robust; abdominal segments not divided into annulets. Anus terminal, a transverse slit. Pleural lobes developed. Integument with small scattered setae ($l = 5$ μm). Spiracles (Fig. 13) (mean diameter 36.5 μm , range $35\text{--}40$ μm , $n = 18$) with peritreme; atrium and opening into subatrium simple, naked.

Cranium.—(Fig. 14) (width 600 μm , height 300 μm) with numerous sparse punctures (diam. 8 μm) and few scattered setae ($l = 7$ μm). Coronal suture and parietal bands absent. Antennal orbits inconspicuous; antennal papilla long ($l = 25$ μm , $w = 15$ μm), located slightly below middle of cranium, with three small sensilla (diam. 10 μm) on apex. Labrum (Fig. 15a) ($w = 365$ μm , $h = 185$ μm) slightly emarginate, with 60 sensilla ($w = 5$ μm) of which 16 ($l = 5$ μm) are marginal and protuberant, and 12 setae ($l = 5$ μm). Epipharynx (Fig. 15b) with 20 sensilla (diam. 10 μm), distributed in four groups of 5: 2 at medio-apical level and 2 at latero-basal level.

Mouthparts.—Mandibles (Fig. 16) ($l = 305$ μm , $w = 108$ μm) tridentate. Maxillae (Fig. 17) ($l = 285$ μm , $w = 140$ μm) with 1 seta ($l = 6$ μm) and 4 sensilla (diam. 5 μm) on external part; mesal margin papillose. Maxillary palpi (diam. 25 μm) with 5 sensilla (diam. 5 μm) at center; galeae present, each represented by one isolated sensillum (diam. 10 μm). Labium (Fig. 17) ($w = 230$ μm , $h = 190$ μm) with 12 sensilla (diam. 5 μm) anterior to spinneret and palpi, and 8 sensilla (diam. 5 μm) behind palpi; palpi short (diam. 30

μm) with 5 sensilla (diam. 5 μm) at center; spinneret a transverse slit ($l = 60$ μm).

The morphology of the cocoon corresponds with the description by Carrillo and Caltagirone (1970) for a cocoon constructed in spring. Krombein (1963) had found a small pore on the cocoon, not mentioned by the previous authors. The only new observation is a darkened ring (brownish-black) on each of the poles.

DISCUSSION

Tormos et al. (1997) characterized the mature larvae of Chrysididae, also pointing out the autapomorphic characters that would define the tribe Elampini: (a) antennal papillae well developed; (b) marginal sensilla of labrum scarce and protuberant; (c) antennal orbits low; and (d) presence of galeae. However, the last two characters mentioned are also present in the larvae of Amiseginae (Tormos et al., unpublished data), a subfamily which, together with Loboscelidiinae, would constitute the adelphotaxon of Chrysidinae (Chrysidini + Elampini) (Kimsey and Bohart, 1990). Accordingly, these two characters (c) and (d) would probably be symplesiomorphic for Chrysidinae, only the first two characters (a) and (b) remaining as autapomorphic for Elampini.

In the four species described, characters (a) and (b) are well defined, although a certain variability as regards the number and development of the marginal sensilla of the labrum can be appreciated; these sensilla are not very protuberant in *H. solierellae* and are numerous (16) in *P. taylori*. Although these two species show greater variability within the tribe Elampini with respect to the arrangement of the marginal sensilla of the labrum, for the time being the character continues to be valid to separate the larvae of Elampini from those belonging to the Chrysidini, since in this latter tribe all known larvae have numerous and not very protuberant sensilla on the labrum.

Since there are a few species of Elampini whose mature larvae are known (two species each of *Hedychridium* Abeille and *Omalus* Panzer and one species each from the genera *Hedychrum* Latreille, *Philoctetes* Abeille, *Pseudolopyga* Krombein and *Pseudomalus* Ashmead), it seems premature to attempt to characterize taxa of this tribe from preimaginal instars. Despite this, from an analysis of the known mature larvae, it may be deduced that *Pseudolopyga* can be characterized by its labium without setae (the larvae of the other genera of Elampini studied have them); likewise, *Hedychridium* has labial palpi with 4 apical sensilla. By contrast, *Omalus*, *Pseudomalus*, and *Philoctetes*, cannot be differentiated on the basis of the larval morphology and are very similar. This could reflect a greater phylogenetic proximity among these three genera, as advanced by

Kimsey and Bohart (1990) from their analysis of imaginal morphology.

Some characters are variable within genera and therefore, at least for the time being, should not be used to establish suprageneric phylogenetic hypotheses: (a) number of mandibular teeth; (b) number of sensilla on the maxillary palpi; (c) number of sensilla on the epipharynx, and (d) number of setae on the labrum. The presence or absence of a coronal suture and parietal bands, together with the greater or lesser development of the galeae, should be analyzed in greater depth.

Until now, only one immature larva of Elampini has been described in detail: *Pseudomalus auratus* (Grandi, 1959). Of the early preimaginal instars of *P. taylori* studied, the presence of a spine on the external apical zone of the mandible of the first larval instar as well as the presence of a final segment complete—not bilobate—are striking; both structures differ with respect to the larva of *Pseudomalus auratus*.

LITERATURE CITED

- Asís, J.D., J. Tormos, and S.F. Gayubo. 1994. Biological observations on *Trypoxylon attenuatum* and description of its mature larva and its natural enemy *Trichrysis cyanea* (Hymenoptera: Sphecidae: Chrysididae). *Journal of the Kansas Entomological Society* 67:199–207.
- Carrillo, J.L., and L.E. Caltagirone. 1970. Observations on the Biology of *Solierella peckhami*, *S. blaisdelli* (Sphecidae), and two species of Chrysididae (Hymenoptera). *Annals of the Entomological Society of America* 63:672–681.
- Enslin, E. 1929. Beiträge zur Metamorphose der Goldwespen. *Zeitschrift für wissenschaftliche Insektenbiologie* 24:116–130.
- Evans, H.E. 1987. Order Hymenoptera. Pp. 597–710, in F.W. Stehr (ed.), *Immature insects*. Vol. 1. Dubuque, IA, Kendall/Hunt Publ. Co.
- Grandi, G. 1959. Contributi alla conoscenza degli Imenotteri Aculeati. *Bolletino dell'Istituto di Entomologia della Università di Bologna* 28:239–292.
- Kimsey, L.S., and R.M. Bohart. 1990. *The Chrysidid Wasps of the World*. Oxford University Press. Oxford. 652 pp.
- Krombein, K.V. 1963. The host-parasite relationship of *Xylocelia virginiana* Rohwer and *Omalus intermedius* (Aaron) (Hymenoptera: Sphecidae, Chrysididae). *Proceedings of the Entomological Society of Washington* 65:264.
- Krombein, K.V. 1967. *Trap-nesting Wasps and Bees. Life Histories, Nests, and Associates*. Smithsonian Press. Washington. 570 pp.
- Maneval, H. 1936. Nouvelles notes sur divers Hyménoptères et leurs larves. *Revue Française d'Entomologie* 3:18–32.
- Soika, A.G. 1934. Études sur les larves des hyménoptères. *Annales de la Société Entomologique de France (N.S.)* 103: 337–344.
- Tormos, J., J.D. Asís, and S.F. Gayubo. 1996. Description of the mature larvae of *Chrysis gracillima* and *Omalus biaccinctus* and new data on the biology of *Trichrysis cyanea* (Hymenoptera: Chrysididae). *Florida Entomologist* 79:56–63.
- Tormos, J., J.D. Asís, and S.F. Gayubo. 1997. Description of the mature larvae of *Chrysis angustula* Schenk and *Hedychiridium elegantulum* Buysson (Hymenoptera, Chrysididae) and phylogenetic importance of larval characters. *Journal of Entomological Sciences* 32: 113–119.

Local Acoustics versus Host Plant Resources: Determinants of Calling Sites in a Tropical Katydid, *Orophus conspersus* (Orthoptera: Tettigoniidae)

By

SARA L. TALIAFERRO¹, DANIEL VICKERMAN², MICHAEL D. GREENFIELD^{3,4}

ABSTRACT Determinants of calling locations of male bush katydids, *Orophus conspersus*, were studied in a field plot at La Selva Biological Station, Costa Rica. We investigated whether calling sites (1) were influenced by attraction toward or repulsion by calling conspecific or heterospecific neighbors, (2) were on or near preferred host plants, or (3) had superior broadcast characteristics. Host plant preferences were determined by a series of laboratory feeding trials, which indicated marked differences in the insects' acceptance of the various plant species in the plot. We concluded that the dispersion of male katydids appears random within the habitat and that neither proximity to preferred food plants nor quality of specific broadcast sites appears to influence the location of male calling. Rather, males call on the tallest local vegetation, possibly because these sites serve as visual beacons.

Key Words: Animal dispersion pattern; Male spacing; Sexual advertisement signaling.

INTRODUCTION

Sexual advertisement in Tettigoniidae (katydids) occurs almost exclusively as male song that either attracts females from a distance or elicits a female (acoustic) reply. Evolution of these acoustic advertisements may have been shaped by sexual selection acting to exaggerate particular characteristics of the song and by natural selection acting to render the males less conspicuous to phonotactic predators and parasitoids (Bailey and Rentz, 1990). Accordingly, males may choose sites that afford superior song propagation, provide protection from natural enemies, offer reduced competition from neighboring males (Shaw et al., 1982; Arak et al., 1990), are rich in food resources, or have adequate oviposition substrates. The two latter factors may lead males to form "resource-based leks" (sensu Alexander, 1975) at particular sites.

Of the various factors that may influence reproductive behavior of tettigoniids and other orthopterans, it is well-documented that females often require specific host plant resources and conditions for feeding and subsequent egg development and oviposition (Spooner, 1968; Feaver, 1977; Meixner and Shaw, 1979; Shaw et al., 1981; Greenfield et al., 1989). Because a female's fitness may be strongly affected by the quality and availability of such resources, reproductive activities may be temporally and spatially linked to the abundance of preferred host plants. In some

species the timing of reproductive cycles and the location of reproductive behavior are influenced by aspects of plant quality. For example, the desert locust, *Schistocerca gregaria* (Acrididae: Cyrtacanthacridinae), does not become sexually mature until the arrival of seasonal rains, which prompt a flush of new growth in the primary food resources (Ellis et al., 1965; Osborne, 1973). Orthopterans may also use preferred food resources as mating territories, as seen in another desert grasshopper, *Ligurotettix coquilletti* (Acrididae: Gomphocerinae). Males of *L. coquilletti* call from and defend individual creosote bushes (*Larrea tridentata*), their primary host plant. Moreover, only certain creosote bushes are regularly defended, and these plants are distinguished by low concentrations of nordihydroguaiaretic acid (NDGA), a phenolic compound in the extra-foliar resin. Greenfield et al. (1989) found that males remaining on bushes with high NDGA titers suffered both reduced survival and growth as well as infrequent matings: Females did not remain long on low-quality bushes (Shelly et al. 1987). Although the distribution of females was partly influenced by males' acoustic signals, the spatial arrangement of host plants of varying quality largely determined the dispersion of both females and males.

The previous examples are taken from habitats with a distinct seasonality and discrete patches of host plants. Insect orientation and mating behaviors may not follow

¹ Department of Botany and Genetics Program, University of Kansas, Lawrence, KS 66045. Present address: Snow Entomological Collection, Division of Entomology, Natural History Museum, University of Kansas, Lawrence, KS 66045.

² Department of Entomology and Department of Systematics & Ecology, University of Kansas, Lawrence, KS 66045. Present address: Department of Entomology, University of California, Riverside, CA 92521.

³ Department of Entomology, University of Kansas, Lawrence, KS 66045. E-mail: greenfie@ukans.edu

⁴ Address for correspondence.

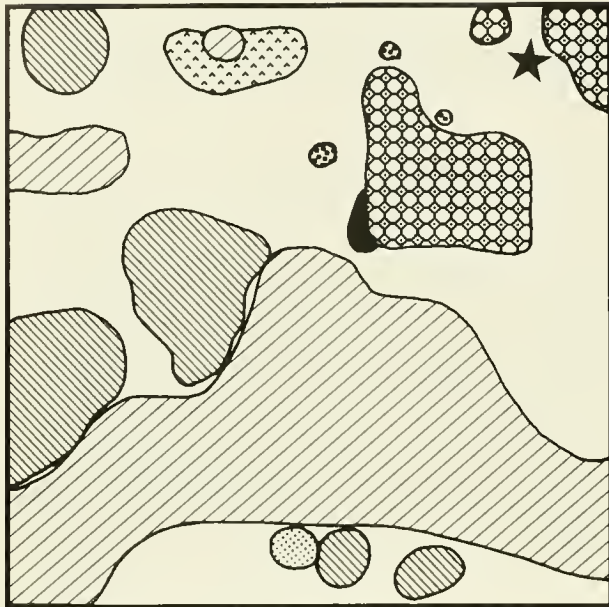









-  *Piper aretum* (Piperaceae)
-  *Hamelia patens* (Rubiaceae)
-  *Heliconia imbricata* (Heliconiaceae)
-  *Pothomorphe peltata* (Piperaceae)
-  *Tripogandra serrulata* (95%; Commelinaceae),
Cyathula prostrata (5%; Amaranthaceae)
-  *Phenax sonnerati* (Urticaceae)
-  *Laportea aestuans* (Urticaceae)
-  *Solanum lancaeifolium* (single plant; Solanaceae)

Fig. 1. Distribution of plant species in a representative 5 m × 5 m section of the study area. *Brachiaria fasciculata* (Gramineae) predominates in the unshaded area, but 2% is *Cyathula achyranthoides* (Gramineae).

the above patterns in a habitat with high plant species diversity and complete ground cover. Confronted with a multitude of potential host plants, females might be less restricted in their movements as they forage. Thus, it may be more critical for males to remain at a site that is suitable for broadcasting calls rather than on preferred host plants. Ideally, a superior broadcasting site would be on or adjacent to preferred host plants and within the home ranges of one or more females.

Some song characteristics of neotropical Tettigoniidae further suggest that the acoustic properties of their calling sites may be more important than in temperate species. The songs of neotropical katydids are usually brief and

sporadic (Belwood, 1990). Call length is normally less than 1 second, and calls may be repeated only following many seconds to several minutes of silence. These call features may represent adaptations for avoiding foliage-gleaning bats (Belwood, 1990), a major guild of insectivores in the neotropics (Heller, 1995). Sound frequencies are generally high, and they are ultrasonic (>20 kHz) in many species (Morris et al. 1994). Neotropical katydids also move very little (generally <1 m) during a 24-hour period (Belwood, 1990). Restricted movement coupled with brief, sporadic calls could make location of males by females rather difficult (Belwood, 1990). High frequency calls, while more readily localized than low frequency ones (Michelsen and Larsen, 1985), would not propagate well over long distances (Griffin, 1971). Thus, features of the calling site that enhance song broadcasting (see Stephen and Hartley, 1991) may be more critical than in other orthopterans.

We studied the determinants of calling sites in a bush katydid, *Orophus conspersus* Bruner von Wattenwyl (Tettigoniidae: Phaneropterinae), at La Selva Biological Station in the Caribbean lowlands of Costa Rica. We investigated whether males of *O. conspersus* called from sites that (1) were dispersed in accordance with attraction toward or repulsion by con- or hetero-specific calling neighbors, (2) were situated on or near preferred host plants, or (3) afforded superior broadcasting characteristics.

ACKNOWLEDGMENTS

This paper is dedicated to the memory of Byron Alexander for his devotion to teaching, scholarship, and fellowship. We would like to thank the Organization for Tropical Studies and its La Selva Biological Station for permission to use their facilities and reserve and for logistic assistance with this project. The Tinker Fund (Latin American Studies), the Department of Entomology, and the Hungerford Fund (Dept. of Entomology) of the University of Kansas provided financial support. We thank Orlando Vargas and G. Stevens for their help in plant identification and several anonymous referees for valuable criticism of the manuscript. This paper reports a project conducted during Field Entomology 1996, Biology 789 (University of Kansas).

METHODS

STUDY SITE

We studied *O. conspersus* within a 30 × 5 m plot that included various woody and herbaceous plants and grasses. This site was a patch of weedy growth along the edge of an area originally cleared for agriculture. The plot was gridded by flagging every 2 m along its length and every 1 m along its width. We created narrow paths along the transverse grid lines so that observations could be made without excessive disturbance of the animals. A vegeta-

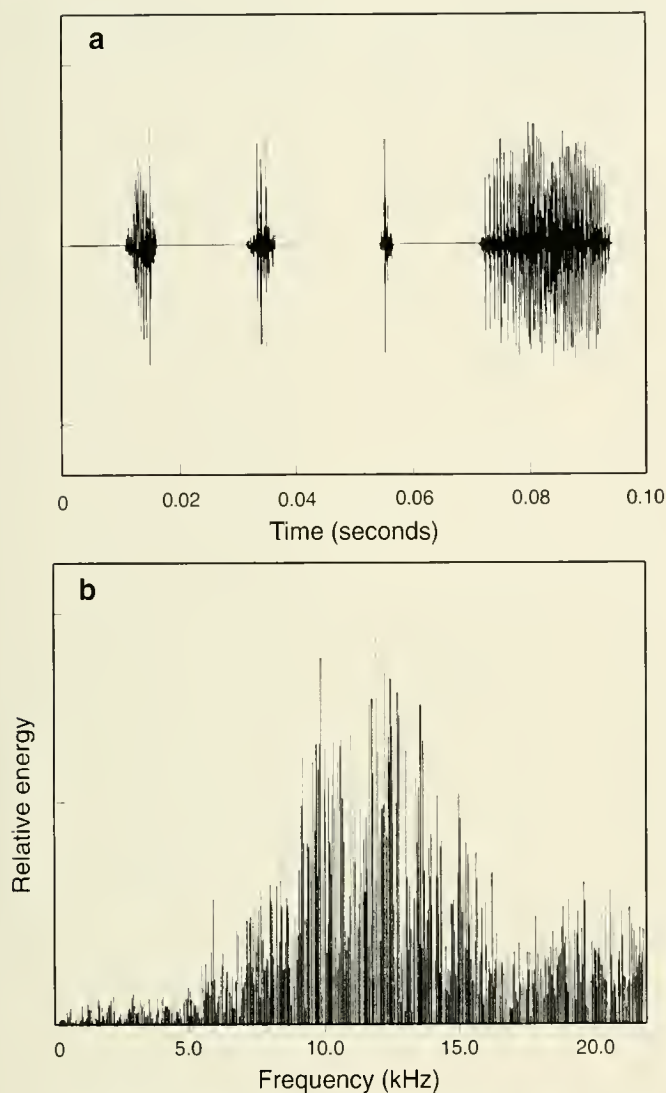

Fig. 2. Calling song of male *Orophus conspersus*; (a) oscillogram, (b) frequency spectrogram. The y-axis is scaled linearly in both (a) and (b). Refer to methods section for equipment.

tion map was generated, and the percent cover of all plant species was estimated within each 2×1 m section (Fig. 1). Twenty-nine plant species in 18 families were found within the plot. Voucher specimens were collected and deposited in the Herbarium of the University of Kansas Natural History Museum.

NATURAL HISTORY OF *OROPHUS CONSPERSUS*

Orophus conspersus is a folivorous katydid found throughout the lowlands of Central America (Rentz, 1983; Nickle, 1992). These katydids may breed continuously throughout the year, although the greatest numbers of adults appear during the rainy season (Rentz, 1983). They are excellent leaf mimics when at rest; both sexes exist in

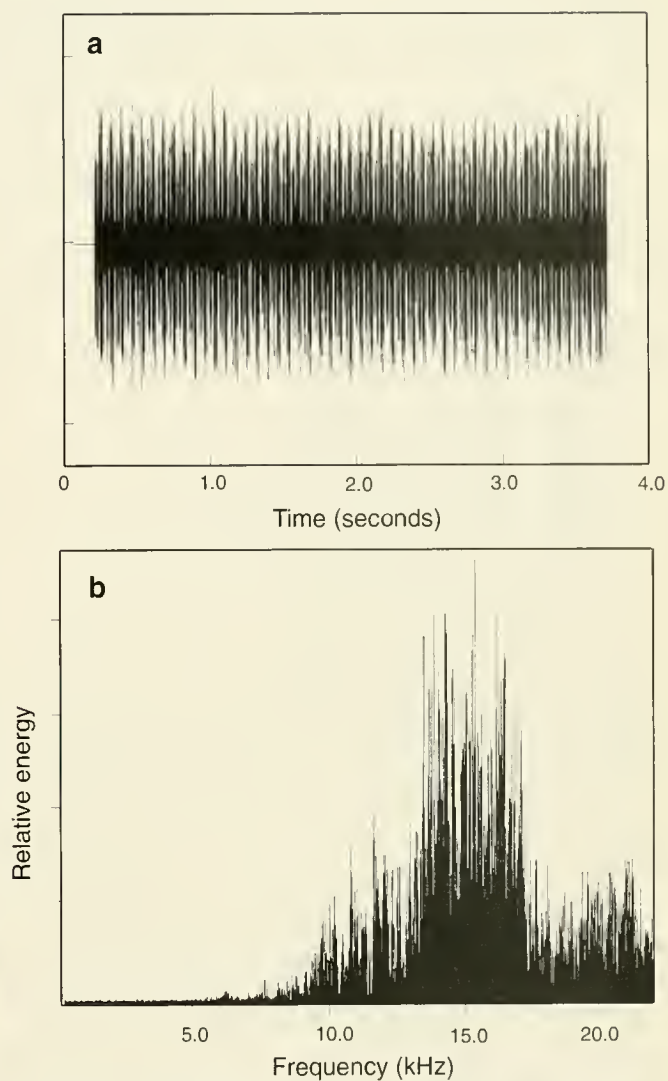

Fig. 3. Calling song of male *Neoconocephalus affinis*; (a) oscillogram, (b) frequency spectrogram. The y-axis is scaled linearly in both (a) and (b). See methods section for equipment used.

two color morphs, greenish-yellow and yellow-brown. Males and females move upward to more conspicuous locations on the vegetation during evening hours, when feeding and mating activities occur. The male calling song (Fig. 2) is a brief "ticking" repeated several times per minute at irregular intervals. Observers can easily monitor this song from at least 5 meters.

STUDY FOCI

Censusing.—From 7 June to 14 June 1996 we conducted a nightly census of calling males of *O. conspersus* between 2030 and 2300 hours, the period of peak acoustic activity. Each 2×1 m section within the plot was monitored during two separate 1-min intervals by two differ-

Table 1. Distribution of plants and *Orophus conspersus* in the field plot and acceptance of the various plant species by *O. conspersus* as determined by laboratory trials. Broadcast sightings are cumulative over the 7-day census period and measure the number of observations of calling males on a given plant species. Percent cover is the estimated percent of the plot covered by a given plant species. Standardized insect distribution is the number of broadcast sightings on a plant species divided by its percent cover. Feeding acceptance is the average time (minutes) spent feeding by the katydids tested in a feeding trial on a given plant species. Values marked by * represent plant species tested on two nights.

FAMILY	SPECIES	BROADCAST SIGHTINGS	PERCENT COVER	STANDARDIZED INSECT DISTRIBUTION	FEEDING ACCEPTANCE
Amaranthaceae	<i>Cyathula achyranthoides</i>	0	0.47	0	0.2
	<i>Cyathula prostrata</i>	0	0.13	0	1.2
Anacardiaceae	<i>Spondias mombin</i>	0	0.32	0	—
Caryophyllaceae	<i>Drymaria cordata</i>	0	0.02	0	—
Commelinaceae	<i>Tripogandra serrulata</i>	0	2.04	0	2.6
Compositae	<i>Mikania micrantha</i>	0	0.27	0	3.1*
	<i>Vernonia brachiata</i>	0	1.3	0	1.5
Cucurbitaceae	<i>Melothria pendula</i>	0	0.16	0	0.7
Cyperaceae	<i>Cyperus tenuis</i>	0	0.08	0	0
	<i>Rhynchospora contracta</i>	0	0.13	0	—
	<i>Scleria pterota</i>	0	0.12	0	0
Gramineae	<i>Axonopus compressus</i>	0	5.24	0	0
	<i>Brachiata fasciculata</i>	1	33.2	0.03	0.3
	<i>Paspalum conjugatum</i>	1	23.1	0.04	1.4
Heliconiaceae	<i>Heliconia imbricata</i>	2	4.85	0.41	0
Lauraceae	<i>Nectandra membranacea</i>	1	0.21	4.76	0
Malvaceae	<i>Sida rhombifolia</i>	0	0.67	0	3.8*
Phytolaccaceae	<i>Rivina humilis</i>	0	0.08	0	—
Piperaceae	<i>Piper arietinum</i>	7	12.8	0.54	0*
	<i>Pothomorphe peltata</i>	0	0.48	0	1.0
Rubiaceae	<i>Hamelia patens</i>	3	8.10	0.37	2.5*
Solanaceae	<i>Browallia americana</i>	0	0.17	0	0
	<i>Solanum americanum</i>	0	0.18	0	0
	<i>Solanum lanceifolium</i>	2	0.18	11.10	0
Thelypteridaceae	<i>Thecopsis torresiana</i>	0	0.02	0	—
Umbelliferae	<i>Hydrocotyle verticillata</i>	0	3.61	0	0
	<i>Spananthe paniculata</i>	2	0.59	3.39	0.5
Urticaceae	<i>Laportea aestuans</i>	0	0.27	0	3.1
	<i>Phenax somneratii</i>	0	0.91	0	4.5*

ent observers. The second observer followed the survey route of the first, approximately 20 min later. When a calling male was observed, his precise location was determined and later marked with flagging tape by the second observer. The height of the calling site and the identity of the plant species were determined the following day.

We also monitored the locations of calling males of *Neoconocephalus affinis* (Beauvois) (Tettigoniidae: Copiphorinae), the other acoustic insect commonly heard singing within the plot at night. This coneheaded katydid produced a continuous, loud song with frequencies similar to that of *O. conspersus* (Fig. 3). Thus, the potential for interspecific acoustic interference, possibly affecting dispersion and calling site selection in *O. conspersus*, existed (Samways, 1977; Greenfield, 1988; Schatral, 1990).

Feeding preferences.—We tested the feeding preferences of *O. conspersus* for the various plant species found within the study plot. Each night before censusing, male and female katydids were collected from areas adjacent to the study plot and placed in 30 × 30 × 30 cm cages where they were provided water from a damp sponge but no food. They did not appear to be weakened by hunger in 24 hours. The following night we placed five katydids at a time on a plant sprig supported in a flask of water and held in a 30 × 30 × 30 cm screen cage. Katydids placed as such readily palpated foliage and fed on certain plant species. Using dim red light, we observed feeding by the katydids for 40 min. Five katydids were used at a time, because all five could feed on the plant sprigs without interference; this number could also be tracked by an observer.

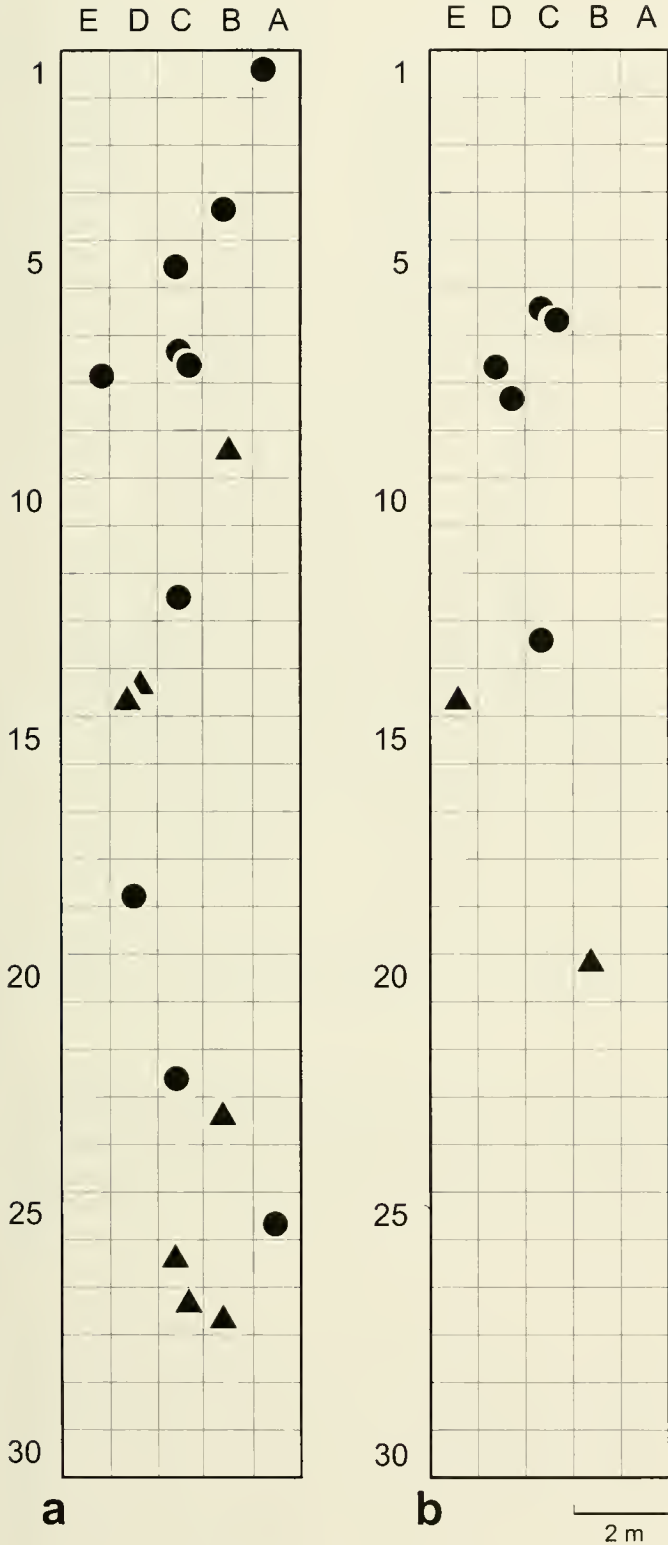

Fig. 4. Distributions of calling males of *Orophus conspersus* (●) and *Neoconocephalus affinis* (▲) in the field plot on 2 representative census nights; (a) 9 June, (b) 12 June.

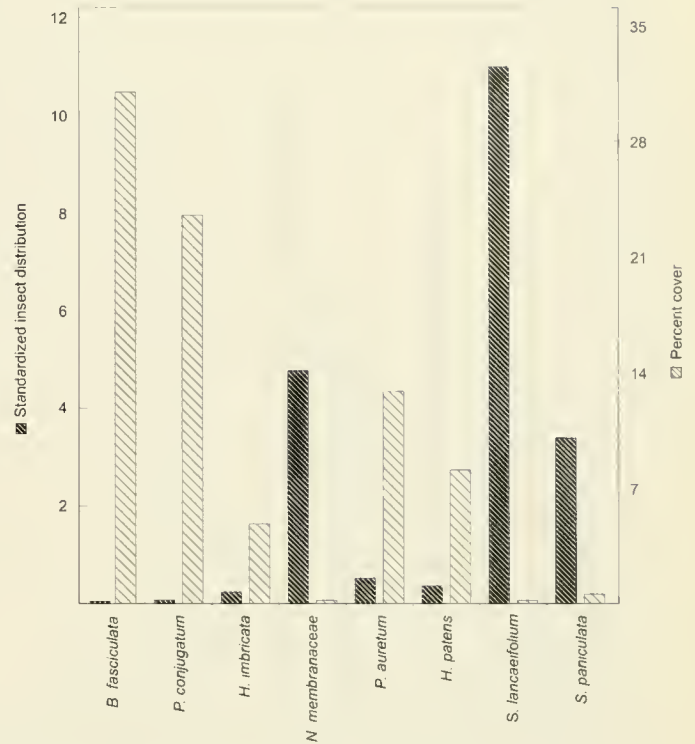

Fig. 5. Standardized insect distribution (see Table 1) and percent cover (see Table 1) for each plant species on which singing males were observed.

Both holding and observation cages were maintained in a screened laboratory room subject to ambient (outdoor) temperature.

Five katydids were tested as above in 40-min trials on 19 of the 29 plant species found within the plot; five additional plant species were tested twice, for a total of 10 katydids tested (Table 1). Five rare plant species were not tested. Of the katydids used, 62% were male and 38% were female. Palpation and nibbling of the sprig and the total amount of time spent actually consuming foliage or flowers were noted for each individual. Upon completion of a trial, the katydids were marked with enamel dots to prevent recapture and released where they had been collected.

Song propagation.—We broadcast recordings of the calling songs of *O. conspersus* at various locations within the plot to determine whether certain sites afforded more superior sound propagation properties than others. Calling songs of six males of *O. conspersus* were recorded with a Casio DA-7 digital cassette tape recorder (48 kHz sampling rate) fitted with a Shure BG-4.0 condenser microphone (flat from 40–18,000 Hz). The recordings were transferred to a computer where they were analyzed with a digital signal-processing program (CoolEdit; Syntrillium, Phoenix, AZ). From these analyses, we selected a representative call (Fig. 2), one with temporal and spectral characteristics average for the sampled males, and prepared a

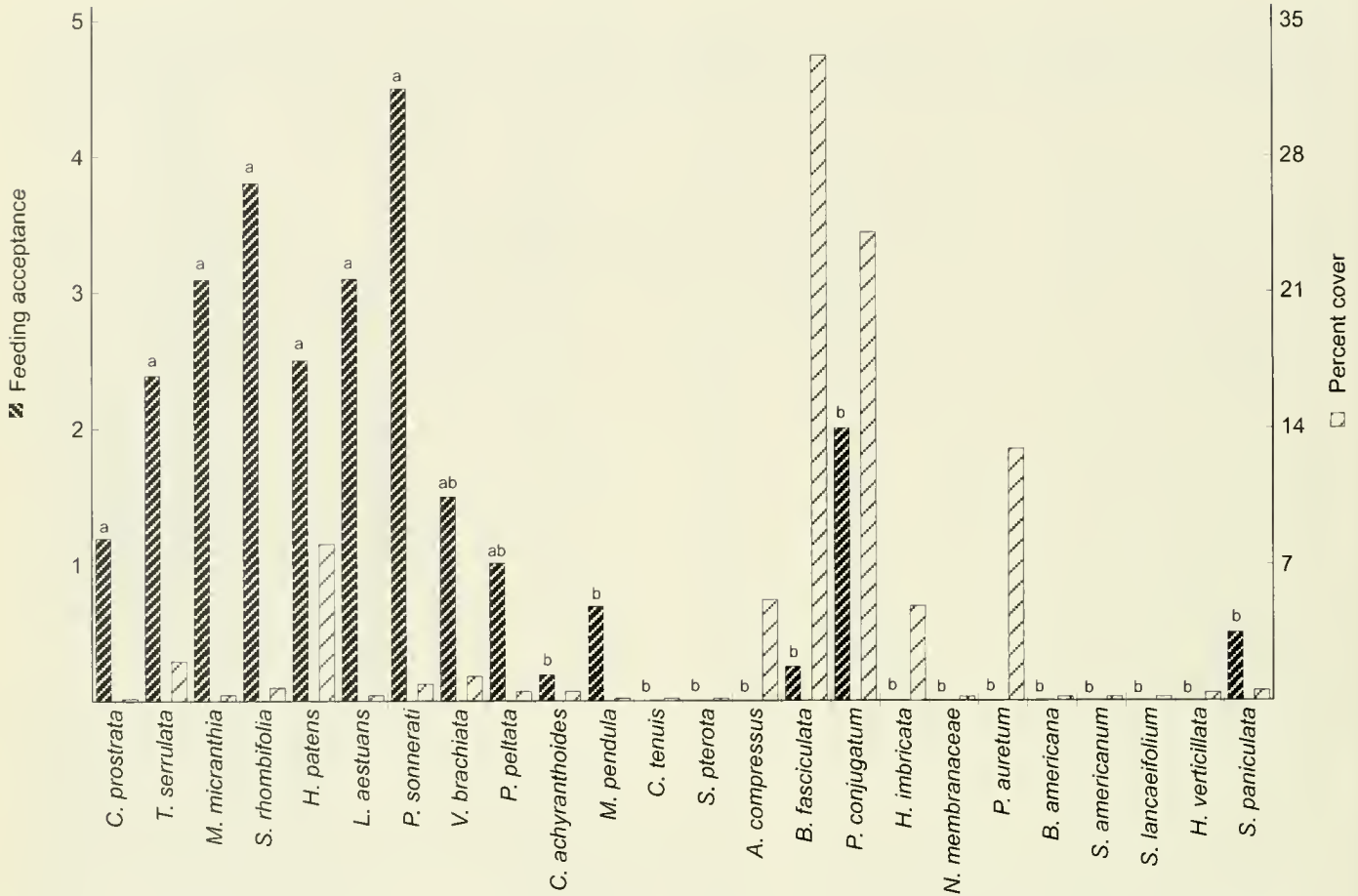

Fig. 6. Feeding acceptance (see Table 1) of the various plant species in the field plot by *Orophus conspersus* and percent cover (see Table 1) of these species. Bars with the same letters are not significantly different from each other ($P > 0.05$) as indicated by Mann-Whitney U-tests, which examined the times spent feeding by individual insects. Percent cover of a plant species and its feeding acceptance by *O. conspersus* were uncorrelated (Spearman rank correlation; $r = -0.34$; $P > 0.05$).

playback stimulus in which that call was repeated, via a loop-back process, every 6.0 s. This stimulus was then transferred back to a cassette tape on the digital tape recorder.

To test the sound propagation properties of a specific site, we broadcast the playback stimulus from an amplified loudspeaker (Radio Shack model 1377; custom amplifier) driven by the digital tape recorder. We set the sound pressure level (SPL) of the stimulus to a standard 68 dB (0 dB = 20 μ Pa), measured 1.0 m horizontal distance in front of the loudspeaker, which was directed horizontally 0.1 m above the ground in an open area adjacent to the plot. SPL was set by adjusting the gain control of the loudspeaker until the broadcast, measured with a General Radio model 1982 precision sound-level meter (its octave bandwidth filter centered at 8 kHz and PEAK setting), reached the desired 68 dB. Using this gain setting, we broadcast the playback stimulus at selected sites. Recordings of these broadcasts showed that our loudspeaker reproduced the

spectral features of the original recording. At each site we successively oriented the loudspeaker in the four cardinal directions and made a minimum of six repeated SPL measurements for each direction. Measurements were taken during the nightly activity period of *O. conspersus*, but never during the intermittent showers that occurred on some nights.

Using the above protocol, we tested song propagation at three different heights above the ground, 0.1, 0.8, and 1.6 m, at two different sites within the vegetation in the plot. SPL measurements were compared among these heights and with measurements made 0.1 m above the ground at two additional sites in an open adjacent area. We then tested song propagation at another eight sites within the plot, six sites which were used by calling males of *O. conspersus* during our censusing and two sites at which calling males were not observed. Vegetation and other physical characteristics of the two latter sites resembled those of the six calling sites. The average height of the six calling sites was 1.1 m.

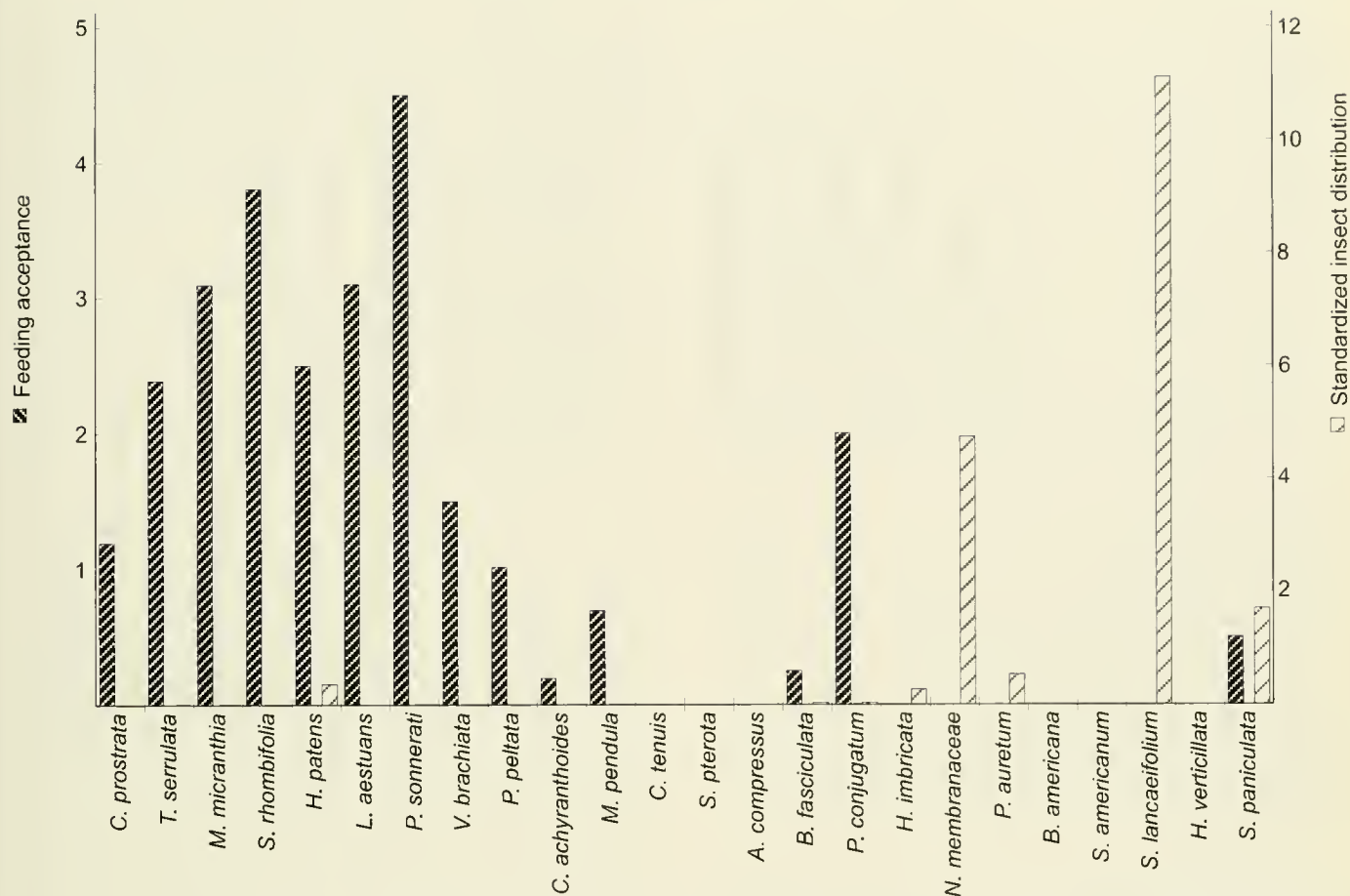

Fig. 7. Feeding acceptance (see Table 1) of the various plant species in the field plot by *Orophilus conspersus* and standardized insect distribution (see Table 1) on these species. Standardized insect distribution and feeding acceptance were uncorrelated (Kolmogorov-Smirnov two-sample test; $D = 22.0$; $P > 0.05$).

STATISTICAL ANALYSES

All analyses were performed using Minitab Statistical Software (PC Version, Release 8, 1991, State College) except the Kolmogorov-Smirnov tests and the coefficients of dispersion, which were calculated as per Sokal and Rohlf (1981).

RESULTS

CALLING SITE DISPERSION

One to 10 calling males of *O. conspersus* were observed on different census nights. The coefficient of dispersion (Sokal and Rohlf, 1981: 87) of their calling sites ranged from 0.57 to 2.84 (1.0 = random dispersion pattern; $CD > 1$, "clumped"; $CD < 1$, "repulsed") among census nights, and the average over all seven nights was 1.14 (Fig. 4).

During the seven nights of censusing within the plot, calling males of *O. conspersus* were observed on eight of the 29 plant species (Table 1). The insects did not use these species of plants as calling sites in proportion to their rela-

tive abundance (Fig. 5). For example, grasses (Gramineae) were the most abundant plants within the plot as measured by percent cover (61%), but *O. conspersus* seldom called from them (10% of total sightings). On the other hand, two plant species, *Piper auretum* and *Hamelia patens*, that combined covered only 20% of the plot accounted for over 50% of the calling sites observed (Fig. 5). *P. auretum* and *H. patens* were among the taller plants within the plot (4 m high, on average).

Calling sites of *O. conspersus* ranged from 0.70 to 1.85 m above the ground, with an average height of 1.24 m. Vegetation in the plot ranged from 0.6 (grasses and forbs) to 4 m in height (*Piper auretum* and *Hamelia imbricata*, for instance); males generally called on taller plants (height > 2 m), but they did not call from the uppermost parts of these plants (see also Rentz, 1983).

Between one and seven calling males of *N. affinis* were observed on different census nights. Coefficients of dispersion of their calling sites ranged from 0.43 to 1.16 among

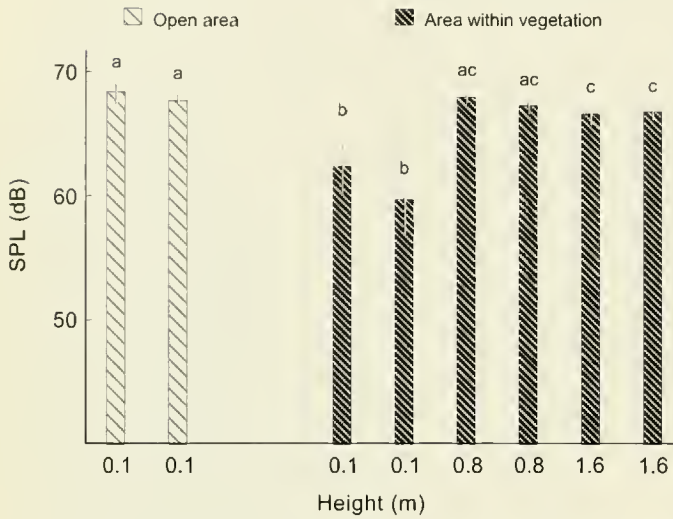

Fig. 8. Sound pressure levels (SPL) of recorded calls of *Orophus conspersus* broadcast from various heights at 2 different locations in an open area and at 2 different locations within dense vegetation in the plot. SPLs were measured at a 1 m horizontal distance from the broadcasting loudspeaker. Bars indicate means of at least 6 measurements taken in each of the 4 cardinal directions; means were calculated by converting dB to Pa, averaging the Pa values, and then reconvertng the averages to dB. Vertical lines indicate ranges. Heights with same letters are not significantly different from each other ($P > 0.05$) as indicated by Mann-Whitney U-tests, which examined individual SPL readings at each height and location.

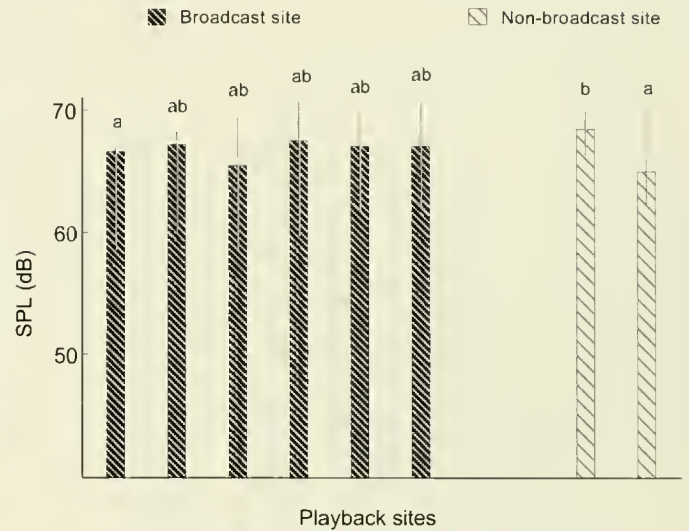

Fig. 9. Sound pressure levels (SPL) of recorded calls of *Orophus conspersus* broadcast from a height of 1.1 m at each of 8 different locations in the plot; 6 broadcast sites and 2 non-broadcast sites. SPLs were measured at a 1 m horizontal distance from the broadcasting loudspeaker. Bars indicate means of at least 6 measurements taken in each of the 4 cardinal directions; means were calculated by converting dB to Pa, averaging the Pa values, and reconvertng the averages to dB. Vertical lines indicate ranges. Bars with the same letters are not significantly different from each other ($P > 0.05$) as indicated by Mann-Whitney U-tests, which examined individual SPL readings at each site.

census nights, and the average over all seven nights was 0.77 (Fig. 4).

FEEDING PREFERENCES

Ten of the 24 plant species tested were neither eaten nor palpated by *O. conspersus* (Table 1). Of the remaining 14 species, only seven were consumed over significantly longer intervals than the ten uneaten species (Fig. 6). *O. conspersus* did not feed on the tough, fibrous blades of Cyperaceae or Gramineae, but they did eat bracts under seeds or soft seed coats. They did not feed on any parts of Solanaceae (Fig. 6).

We observed no correlation between percent cover of a plant species and preference for it in feeding trials (Fig. 6). More importantly, there was no correlation between the popularity of a plant species as a calling site and the preference for it in feeding trials (Fig. 7). For example, *H. patens* served as a most popular calling site, but *O. conspersus* ate only its young foliage. On the plant, young leaves of *H. patens* occur only at the apex, whereas *O. conspersus* was never observed there. Further, only 32% of the broadcast sites were located within a 1.0-m radius of a plant species preferred in feeding trials, and only 19% of the broadcast sites were near preferred plant species other than *H. patens*.

SONG PROPAGATION

We found that the song of *O. conspersus* was propagated more effectively in open areas and higher above the ground. At an elevation of 0.1 m, playback stimuli were attenuated to a significantly greater extent within the vegetation of the plot than in adjacent open areas (Fig. 8). And within the vegetation of the plot, attenuation was significantly greater at 0.1 m than at 0.8 or 1.6 m, but no difference was noted between 0.8 and 1.6 m (Fig. 8). Attenuation of test sounds appeared the same whether broadcast from locations used as calling sites or from other locations at comparable sites (Fig. 9).

DISCUSSION

Calling males in various Orthoptera aggregate at valuable resources (Campbell and Clarke, 1971; Shaw et al., 1981; Shelly et al., 1987), while others exhibit regular dispersion patterns (Meixner and Shaw, 1979; Bailey and Thiele, 1983; Schatral and Yeoh, 1990; Rheinlaender and Römer, 1990), presumably as a consequence of territorial defense (Greenfield, 1997) and/or to maximize rates of encounter with females (Arak et al., 1990). Nonetheless, we found that coefficients of dispersion of *O. conspersus* on successive census nights ranged between aggregated

and uniform values. These fluctuations probably reflect small sample sizes of individuals and cannot be regarded as conclusive, yet they are consistent with an overall pattern of random dispersion. Neither aggregated nor uniform dispersion would be expected in *O. conspersus*, as preferred food resources do not form discrete patches, and there exists no evidence for territorial or aggressive behavior.

Does the distribution of valuable food resources, or preferred host plants, influence selection of calling sites in *O. conspersus*? Little information is available on feeding preferences in Tettigoniidae; e.g., neotropical Phaneropterinae are assumed to be rather generalist folivores (Rentz, 1983; Nickle, 1992). Our study indicated, however, that *O. conspersus* readily consumed leaves of fewer than 20% of the plant species available in its habitat and harbored no special preference for the more common species. Despite this level of oligophagy, though, we found no evidence that the fine-scale (within habitat) selection of a calling site was influenced by its value as a food resource. And the one plant species preferred in feeding trials that was also a popular calling site, *H. patens*, is unlikely to serve as a food source in the field.

Local acoustics appear to represent the strongest influence on selection of calling sites in *O. conspersus*, but the impact of this factor too appears limited. The song propagation characteristics of sites near the ground within the vegetation of the plot, where the insects rest during the day, are clearly inferior. Thus, the elevation of calling sites above the ground affords males reduced attenuation of their songs and the potential for advertising to a greater number of receptive females (Paul and Walker, 1979). Reverberation, and consequently distortion of critical temporal features of the song, may also be reduced at these elevated calling sites. Our findings also show that calling at elevations above those typically used would not improve a male's broadcasting ability. Use of such elevated sites also may render him less easily localized by females approaching via walking (see Walker, 1983). Nonetheless, the specific sites selected by calling males are not acoustically distinguished from general locations at their elevation. Rather, males generally select sites on the tallest vegetation, even though they do not avail themselves of the full height of these plants. Possibly, these plants represent visual "beacons" for males and females during crepuscular movements. Additionally, their stems and foliage may serve as superior platforms for calling males. We observed no interest by the many bats at our field plot in *O. conspersus* or in loudspeaker-broadcast songs of *O. conspersus*, and therefore we do not suggest that the fine-scale selection of calling sites is influenced by any local protection from bats or other phonotactic natural enemies.

Our study considered various social and physical factors that may influence where males advertise within their preferred habitat. We found that other than selecting broadcast sites on the tallest vegetation, males of *Orophus conspersus* appeared to be randomly dispersed within the plot. Neither proximity to preferred food sources nor superiority of broadcast quality were obvious factors influencing advertisement locations of males. Future studies should further examine the orientation of males toward taller plants and their selection of particular sites on those plants. Oviposition substrates, not considered in our study, may also play a role in determining males' calling sites. During our feeding trials, two different females were observed attempting to oviposit into leaves of *Heliconia imbricata* and *Axonopus compressus*, respectively (see Rentz, 1983). If plant species and leaves vary in their quality as potential oviposition substrates, males might preferentially call from the more desirable sites. This would be particularly likely if (last male) sperm precedence and the opportunity to mate with a female just prior to oviposition exist.

LITERATURE CITED

- Alexander, R.D. 1975. Natural selection and specialized chorusing behavior in acoustical insects. Pp. 35-77, in D. Pimentel (ed.), *Insects, Science, and Society*. Academic Press, New York.
- Arak, A., T. Eiriksson, and T. Radesäter. 1990. The adaptive significance of acoustic spacing in male bushcrickets *Tettigonia viridissima*: a perturbation experiment. *Behavioral Ecology and Sociobiology* 26: 1-7.
- Bailey, W.J. and D.C.F. Rentz. 1990. *The Tettigoniidae: Biology, Systematics, and Evolution*. Crawford House Press, Bathurst, Australia, 395 pp.
- Bailey, W.J. and D.R. Thiele. 1983. Male spacing behavior in the Tettigoniidae: an experimental approach. Pp. 163-184, in D.T. Gwynne and G.K. Morris (eds.) *Orthopteran Mating Systems: Sexual Competition in a Diverse Group of Insects*. Westview Press, Boulder, CO.
- Belwood, J.J. 1990. Anti-predator defenses and ecology of neotropical forest katydids, especially the Pseudophyllinae. Pp. 8-26, in W.J. Bailey and D.C.F. Rentz (eds.), *The Tettigoniidae: Biology, Systematics, and Evolution*. Crawford House Press, Bathurst, Australia.
- Campbell, D.J. and P.J. Clarke. 1971. Nearest neighbor tests of significance for nonrandomness in the spatial distribution of singing crickets *Teleogryllus commodus* (Walker). *Animal Behaviour* 19: 750-756.
- Ellis, P.E., D.B. Carlisle, and D.J. Osborne. 1965. Desert locusts: sexual maturation delayed by feeding on senescent vegetation. *Science* 149: 546-547.
- Feaver, M. 1977. Aspects of behavioral ecology of three species of *Orchelimum* (Orthoptera: Tettigoniidae). Ph. D. dissertation, University of Michigan, Ann Arbor. 199pp.
- Greenfield, M. D. 1988. Interspecific acoustic interactions among katydids (*Neoncoucephalus*): inhibition-induced shifts in diel periodicity. *Animal Behaviour* 36: 684-695.
- Greenfield, M.D. 1997. Sexual selection in resource defense polygyny: lessons from territorial grasshoppers. Pp. 75-88, in: Choe, J.C. and B.J. Crespi (eds.), *The Evolution of Mating Systems in Insects and Arachnids*. Cambridge University Press, Cambridge, U.K.
- Greenfield, M.D., T.E. Shelly, and A. Gonzalez-Coloma. 1989. Territory selection in a desert grasshopper: the maximization of conversion efficiency on a chemically defended shrub. *Journal of Animal Ecology* 58: 761-771.

- Griffin, D.R. 1971. The importance of atmospheric attenuation for the echolocation of bats (Chiroptera). *Animal Behaviour* 19: 55-61.
- Heller, K.-G. 1995. Acoustic signalling in palaeotropical bushcrickets (Orthoptera: Tettigoniidae: Pseudophyllidae): does predation pressure by eavesdropping enemies differ in the Palaeo- and Neotropics? *Journal of Zoology (London)* 237: 469-485.
- Meixner, A.J. and K.C. Shaw. 1979. Spacing and movement of singing *Neoconocephalus nebrascensis* males (Tettigoniidae: Copophorinae). *Annals of the Entomological Society of America* 72: 602-606.
- Michelsen, A. and O.N. Larsen. 1985. Hearing and sound. Pp. 495-556, in G.A. Kerkut and L.I. Gilbert (eds.), *Comprehensive Insect Physiology, Biochemistry and Pharmacology*. Vol. 6. Pergamon Press, Oxford, U.K.
- Morris, G.K., A.C. Mason, P. Wall, and J.J. Bellwood. 1994. High ultrasonic and tremulation signals in neotropical katydids (Orthoptera: Tettigoniidae). *Journal of Zoology* 233(1): 129-163.
- Nickle, D.A. 1992. Katydids of Panama (Orthoptera: Tettigoniidae). Pp. 142-184, in D. Quintero and A. Aiello (eds.), *Insects of Panama and Mesoamerica, Selected Studies*. Oxford University Press, London.
- Osborne, D.J. 1973. Mutual regulation of growth and development in plants and insects. Pp. 33-42, in H.F. Van Emden (ed.), *Insect/Plant Relationships*. Blackwell, Oxford.
- Paul, R., and T.J. Walker. 1979. Arboreal singing in a burrowing cricket, *Anurogryllus arboreus*. *Journal of Comparative Physiology A* 132: 217-223.
- Rentz, D.C.F. 1983. *Orophus conspersus* (Esperanza, Bush Katydid). Pp. 749-750, in D.H. Janzen, (ed.), *Costa Rican Natural History*. University of Chicago Press, Chicago, IL.
- Rheinlaender, J., and Römer, H. (1990) Acoustic cues for sound localization and spacing in orthopteran insects. Pp. 248-264, in W.J. Bailey and D.C.F. Rentz (eds.), *The Tettigoniidae: Biology, Systematics, and Evolution*. Crawford House Press, Bathurst, Australia.
- Samways, M.J. 1977. Bush cricket interspecific acoustic interactions in the field (Orthoptera, Tettigoniidae). *Journal of Natural History* 11: 155-168.
- Schatral, A. 1990. Interspecific acoustic behaviour among bushcrickets. Pp. 152-165, in W.J. Bailey and D.C.F. Rentz (eds.), *The Tettigoniidae: Biology, Systematics, and Evolution*. Crawford House Press, Bathurst, Australia.
- Schatral, A. and P. Yeoh. 1990. Spatial distribution, calling and interspecific acoustic interactions in two species of the Australian tettigoniid genus *Tymphanophora* (Orthoptera: Tettigoniidae). *Journal of Zoology* 221: 375-390.
- Shaw, K.C., R.C. North, and A.J. Meixner. 1981. Movement and spacing of singing *Amblycorypha parvipennis* males. *Annals of the Entomological Society of America* 74: 436-444.
- Shaw, K.C., R.J. Bitzer, and R.C. North. 1982. Spacing and movement of *Neoconocephalus ensiger* males (Conocephalinae: Tettigoniidae). *Journal of the Kansas Entomological Society* 55(3): 581-592.
- Shelly, T.E., M.D. Greenfield, and K.R. Downum. 1987. Variation in host plant quality: influences on the mating system of a desert grasshopper. *Animal Behaviour* 35: 1200-1209.
- Sokal, R.R. and F.J. Rohlf. 1981. *Biometry: The Principles and Practice of Statistics in Biological Research*. 2nd ed. W.H. Freeman and Company, New York. 859 pp.
- Spooner, J.D. 1968. Pair-forming acoustic systems of phaneropterine katydids (Orthoptera, Tettigoniidae). *Animal Behaviour* 16:197-212.
- Stephen, R.O. and J.C. Hartley. 1991. The transmission of bush-cricket calls in natural environments. *Journal of Experimental Biology* 155: 227-244.
- Walker, T.J. 1983. Mating modes and female choice in shorttailed crickets (*Anurogryllus arboreus*) Pp. 240-267, in D.T. Gwynne and G.K. Morris (eds.), *Orthopteran Mating Systems: Sexual Competition in a Diverse Group of Insects*. Westview Press, Boulder, CO.

Revision of the Species of the Subgenera of *Exomalopsis* Spinola, 1853, Occurring in South America. I: *Diomalopsis* Michener & Moure, 1957 (Hymenoptera: Apidae), and a Revised Key to the Subgenera

By

EDUARDO A. B. ALMEIDA¹ AND FERNANDO A. SILVEIRA¹

ABSTRACT Two species are considered in *Exomalopsis* (*Diomalopsis*): *E. bicellularis*, the type species from southeastern Brazil, and *E. alexanderi*, described here as new, from Paraguay. Characters traditionally used to define *Diomalopsis* are discussed and new synapomorphies presented. A revised key for the subgenera of *Exomalopsis* is provided to incorporate characters recently discovered.

Keywords: Taxonomy; Solitary bee; Exomalopsini; *Exomalopsis*; *Diomalopsis*; Apidae.

INTRODUCTION

The scope of *Exomalopsis* was recently changed by Silveira (1995) who considered *Anthophorula* Cockerell, 1897, and *Anthophorisca* Michener & Moure, 1957, as subgenera of a separate genus, *Anthophorula*. The remaining species of *Exomalopsis* were then distributed in four subgenera: *Exomalopsis s.str.* (including *Megomalopsis* Michener & Moure, 1957), *Phanomalopsis* and *Diomalopsis* (both described by Michener & Moure, 1957) and *Stilbomalopsis* Silveira, 1995. This is the first of three papers dealing with the species of the subgenera of *Exomalopsis* occurring in South America. In the next two we will treat *Phanomalopsis* and *Exomalopsis s.str.*

Diomalopsis was described by Michener & Moure (1957) for a single species, *Exomalopsis bicellularis*, from southern Brazil. Here we discuss some characters used by them to define the group; new synapomorphies are indicated for the subgenus; and a new species is described. Additionally, a revised key for the subgenera of *Exomalopsis* is provided.

ACKNOWLEDGMENTS

This paper was prepared with the support of the Brazilian council for development of science and technology (CNPq), which granted fellowships to both authors. We are indebted to T.L.Griswold, of the USDA-ARS Bee Biology and Systematics Laboratory and Utah State University at Logan, to J.M.F.Camargo, of the Universidade de São Paulo at Ribeirão Preto, and to J.S. Moure, from the Universidade Federal do Paraná, Curitiba, for the loan of the material examined. D.A.Yanega corrected English mistakes in the manuscript; and G.W.Fernandes kindly allowed us to use his photographic equipment for the preparation of figures. The support by the late B.A.Alexander

and C.D.Michener to F.A.S. during his stay at the University of Kansas was a stimulus for undertaking this work.

MATERIAL AND METHODS

Morphological terminology used here is mainly that of Michener (1944), with the following additions: The word *vertex* is used in reference to the topmost area of the head between the lateral ocelli and the eye. Following Silveira (1995), we refer to the occipital carina and occipital fringe of previous authors as the *postocellar ridge* and *postocellar fringe*, respectively. The band of erect plumose hairs along the posterior margin of the scutellum is the *scutellar fringe*. The patch of erect plumose hairs on the mid metanotum, contiguous with the scutellar fringe, is the *metanotal tuft*. Metasomal terga and sterna are referred to, respectively, as T-1, T-2, etc., and S-1, S-2, etc. In referring to regions of the antenna, it is assumed that the antenna is extended so that its long axis is perpendicular to the plane of the face and parallel to the long axis of the bee's body.

Size of punctures is expressed in an absolute but subjective scale representing a size class (minute, very fine, moderately coarse and coarse). Density of punctures, however, is expressed relative to the size of punctures (number of puncture diameters between the margins of two closest punctures). Thus, distance between dense, fine punctures is actually smaller than that between dense, coarse punctures.

RESULTS

Subgenus *Diomalopsis* Michener & Moure

Diomalopsis Michener & Moure, 1957:431. Type species: *Exomalopsis bicellularis* Michener & Moure, 1957 (original designation).

¹ Laboratório de Sistemática e Ecologia de Abelhas, Departamento de Zoologia, ICB, Universidade Federal de Minas Gerais. C.P. 486. 31.270-901 Belo Horizonte, MG, BRAZIL. E-mail: ealmeida@mono.icb.ufmg.br

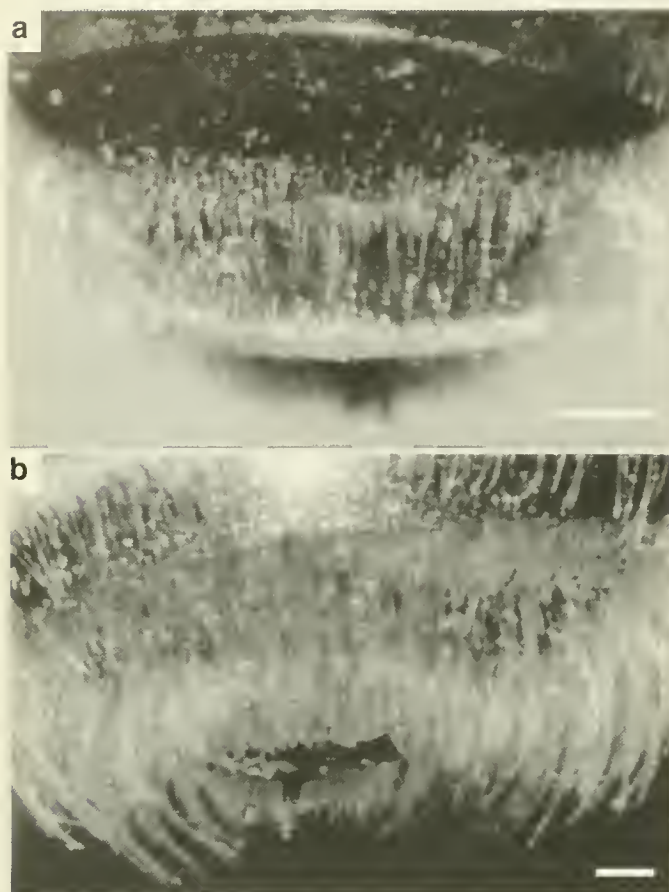

Fig. 1. Apical fimbriae of T-5 and T-6 of female of (a) *E. (Diomalopsis) alexanderi* (paratype) and (b) *E. (Phanomalopsis) snowi*. Scale line = 0.2 mm.

In their description of the subgenus, Michener & Moure called the attention to the following characters which distinguish this group from *Exomalopsis s.str.*: 1) head short behind ocelli but without evidence of a postocellar ridge (preoccipital carina in their paper); 2) paraocular carina present; 3) pterostigma longer than length of marginal cell on wing margin, over five times as long as prestigma and much wider than latter; 4) two submarginal cells; 5) seventh sternum of male with broadly truncate distal process bearing thickened or peg-like hairs; eighth sternum with postapodomal part large, truncate apically, strongly constricted basally, hairy; 6) dorsal gonocoxal bridge short. They observed that the lack of a preoccipital carina and presence of paraocular carinae resemble characters of *Anthophorula*, *Anthophorisca* and some species of *Phanomalopsis*, and that characters 3, 5 and 6 above were "completely unlike those of any other *Exomalopsis*" known to them. The paraocular carinae, however, are also present at least in several species of the subgenera *Exomalopsis s.str.* and *Phanomalopsis* (*sensu* Silveira, 1995), being absent only in the species of *Stilbomalopsis* Silveira examined by us.

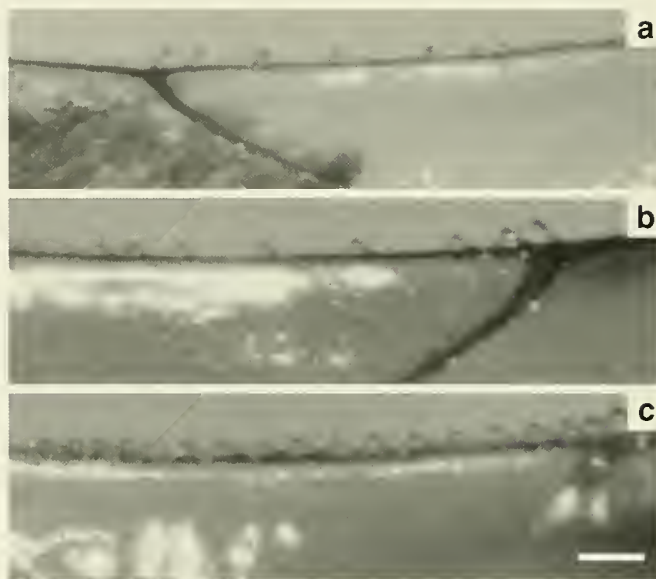

Fig. 2. Hamuli of right wing of female of (a) *E. (Diomalopsis) alexanderi* (paratype) and of left wing of female of (b) *E. (Diomalopsis) bicellularis* and (c) *E. (Phanomalopsis) snowi*. Scale line = 0.1 mm.

In Silveira (1995), *Diomalopsis* was defined by the following unique apomorphies (only one species was available then): Disc of S-7 of male subtriangular, with basilateral expansions (Fig. 8f in Silveira, 1995; his character 60-6); disc of S-8 of male with a median longitudinal carina for almost all the sternal length (Fig. 9g in Silveira, 1995; his character 66-1—also present, among the *Exomalopsini*, in *Eremapis* Ogloblin and *Anthophorula*) and apical process of S-8 of male long with a single, broad, flat, hairy lobe, separated from disc by long, strongly constricted stalk (character 67-9). With the addition of another species, three characters can be established as synapomorphies for the subgenus: 1) two submarginal cells (highly variable in other groups, but consistently three in all other subgenera of *Exomalopsis*); 2) the apical fimbriae of T-5 and T-6 of females, the hairs of which are dense, long and have straight apices (in other groups the fimbriae are generally made of thin, short, and curved hairs; Fig. 1) and 3) the arrangement of the hamuli on the margin of the posterior wing. In all other subgenera of *Exomalopsis*, the hamuli are closely and evenly spaced; in *Diomalopsis*, they are characteristically arranged (Fig. 2) with a set of three, close hamuli at either end of the row, and one or two between them.

Exomalopsis (Diomalopsis) bicellularis
Michener & Moure

Fig. 2b

Exomalopsis (Diomalopsis) bicellularis Michener & Moure, 1957:449-450.

Michener & Moure (1957) gave an extensive description for both sexes of this species.

Holotype male.—Curitiba, Paraná, Brazil; September, 1943 [R.B.Lange]. Deposited at the Departamento de Zoologia, Universidade Federal do Paraná, Curitiba, Brazil (Moure's collection) (Curitiba is at 25° 20' S, 49° 10' W).

Paratypes.—One female and one male, same locality, date and collector as holotype. The female is deposited with the holotype, the male in the Snow Entomological Division of the Natural History Museum, University of Kansas, Lawrence, Kansas. One female paratype, same locality, November 1, 1956 [C.D.Michener & R.B.Lange], in the collection of C.A.Campos Seabra, which is being moved to the Museu Nacional, Rio de Janeiro, Brazil.

Besides the types at Lawrence and Curitiba, the following material was examined: two males deposited in the Departamento de Zoologia, Universidade Federal do Paraná, Curitiba, Brazil (Moure's collection), one from Curitiba, Paraná, Brazil; 950 m.a.s.l., September 27, 1955 [Michener & Lange] and the other from Guarapuava, Paraná, Brazil; 1120 m.a.s.l.; September 7, 1955 [Michener & Moure] (Guarapuava is at 25°20'S, 51°30'W). Three females (collected on July 20, 1992, May 2 and October 13, 1993) and one male (collected on May 10, 1992) deposited at the Departamento de Biologia, Universidade de São Paulo, Ribeirão Preto, Brazil (Camargo's collection), from Salesópolis, São Paulo, Brazil; Estação Ecológica da Boracéia, 800–900 m.a.s.l.; 23°32'S, 45°51'W [Wolfgang Wilms].

Exomalopsis (Diomalopsis) alexanderi n.sp.

Figs. 1a, 2a

This species can best be distinguished from *E. bicellularis* by its smaller size (length less than 5 mm in *alexanderi* and more than 6 mm in *bicellularis*), the brownish tegula (in *bicellularis* it is black), the pale yellow hairs on the mesosoma and the whitish tomentum on the paraocular areas (both black in *bicellularis*).

Female.—*Body color:* Black, except as follows: apical margin of clypeus dark ferruginous; pregradular region of S-2 to S-4 ferruginous; tarsi, tibial spurs and strigilis light ferruginous; apical half of mandible, flagellum dorsally, pedicel, scape, tegula and wing veins dark brown; tibiae, femora, trochanters, disc of S-1 and S-2 brownish black; flagellum ventrally and pterostigma light brown; wings hyaline with brownish tint.

Pubescence: Pale yellow, except: scopa fuscous medially and posteriorly on tibia and posteriorly on basitarsus; whitish on paraocular areas, clypeus, genae, coxae, trochanters, femora, propodeum, mesepisterna, venter of mesosoma, laterally on appressed hairs of T-1 and T-2, apical bands of T-3 and T-4, metasomal sterna; apical fim-

brae of T-5 and T-6 black, depending on light incidence. Hairs semierect, forming apical fringe on labrum; on clypeus semierect and fine, homogeneously distributed; on supraclypeal area semidecumbent; inferiorly on paraocular area decumbent; on the rest of frons semierect and more densely plumose; on gena, semierect and fine, becoming more erect away from eye; on postocellar fringe short, erect, and densely plumose; on pronotum long erect and densely plumose; on disc of mesoscutum semidecumbent and densely plumose, longer on anterior third; on anterior margin of scutellum short and plumose; scutellar fringe and metanotal tuft long, erect, and densely plumose; on anterior third of propodeum short and semidecumbent, decumbent on lateral areas; on mesepisternum semidecumbent, long, and plumose; laterally on marginal areas of T-1 to T-3 forming appressed patches; on posterior edges of T-3 to T-5 forming ill-defined bands. Denser on apex than on base of forewing.

Punctures: On labrum coarse and dense (one diameter or less apart from each other), leaving a median longitudinal band and two apico-lateral areas smooth; on clypeus moderately coarse and sparse (one to two diameters apart), intermixed with finer punctures; on supraclypeal area moderately fine and sparse (one to three diameters apart), becoming denser toward supra-antennal area and leaving a median longitudinal band smooth; on front and vertex fine and sparse (two to four diameters apart); on gena fine and very sparse (three to five diameters apart), becoming denser toward vertex; behind ocelli coarse and dense (one or less diameter apart); between ocelli fine and sparse (two to four diameters); on disc of mesoscutum moderately fine and sparse (one to three diameters), becoming denser on posterior third medially; on scutellum moderately fine and sparse (one to three diameters apart) on anterior margin, disc impunctate; on lateral portions of metanotum and on mesepisternum, minute and sparse (two to five diameters apart); on propodeum fine and sparse (two to four diameters apart) on anterior third, impunctate posteriorly; dorsal surface of T-1 mostly shiny and impunctate, but moderately fine and sparse (one to three diameters apart) on lateral areas and along transverse carina; on T-2 fine and sparse (two to three diameters apart) laterally and anteriorly, very minute and sparse (more than five diameters apart) elsewhere; on T-3, and T-4 fine and sparse (two to four diameters apart); on T-5 fine and very dense (less than one diameter apart).

Structure: Labrum trapezoidal, disc plane, lateral parts folded back at right angle to disc; clypeus gently convex, disc plane, apical margin delimited by a strongly punctured transverse line; frontal sulcus short and ill-defined; hamuli, seven per wing and unevenly spaced; disc of T-1 one-fourth of dorsal surface of tergum.

Measurements of holotype (mm): Approximate length of body = 4.8; of forewing = 4.4. Length and width of head = 1.42, 1.81. Maximum, inferior and superior distance between eyes = 1.06, 1.03, 0.97. Interocellar and ocellar-ocular distances = 0.31, 0.23. Diameters of mid and lateral ocelli = 0.14, 0.13. Length and diameter of scape = 0.49, 0.13. Length of pedicel, 1st, 2nd, 3rd and terminal flagellomeres = 0.14, 0.18, 0.11, 0.11, 0.25. Diameter of 5th flagellomere = 0.13. Length and width of mesoscutum = 1.06, 1.53. Length and width of prestigma = 0.14, 0.11. Length and width of preostigma = 0.76, 0.23. Length and width of marginal cell (measured on wing margin) = 0.63, 0.36.

Male.—Unknown.

Holotype female.—Paraguay, San Pedro Cororo, Rio Ypane; Malaise trap; XI-27/30-1983 [M. Wasbauer]. Deposited at the ARS-USDA Bee Biology & Systematics Laboratory, Utah State University, Logan, Utah, U.S.A. (No geographic coordinates were found for the type locality. The Ypane river flows between 56°W and 57°30'W and between 23°S and 23°30'S.)

Paratype females.—Same locality, date and collector as holotype. Three deposited with the holotype; one deposited in the Snow Entomological Division of the Natural History Museum, University of Kansas, Lawrence, Kansas; one in the collection of the Departamento de Zoologia da Universidade Federal de Minas Gerais, Belo Horizonte, Brazil.

Key to Subgenera of *Exomalopsis*

In his paper, Silveira (1995) included a key for the subgenera of *Exomalopsis* in which the subgenera *Exomalopsis*, *Phanomalopsis* and *Diomalopsis* were separated in a triplet. This was done because the only character available to distinguish clearly the female *Diomalopsis* was that it possesses two instead of three submarginal cells. Since this character is highly variable among bees, it was felt that no emphasis should be given to it in a key. Now, two additional unique characters have been found for the female *Diomalopsis*, and the examination of thousands of specimens of all other subgenera of *Exomalopsis* suggested that none of them includes species with two submarginal cells. For this reason, a revised key for the subgenera of *Exomalopsis* is provided below:

1. Vertex in frontal view convex; lateral ocelli below level of summit of head; paraocular carina absent; marginal zone of T-1 and T-2 of female smooth and glabrous; white, dense, apical fascia present on T-2 to T-4 of female, sometimes interrupted medially; apical

process of S-7 of male present as narrow, transverse sclerite fused laterally to arms of disc; apical process of S-8 of male a single bare lobe. *Stilbomalopsis*

—Vertex in frontal view straight; lateral ocelli at least partly above level of summit of head; paraocular carina present; marginal zone of T-1 and/or T-2 of female punctate and pilose; apical fascia absent or present on T-2 to T-4 of female; apical process of S-7 of male absent or complex and with two free basi-lateral lobes under ventral surface; apical process of S-8 of male bearing two apical arms (short or long); if a single lobe, the lobe is hairy. 2

2. Vertex of female between ocellus and eye strongly excavated; postocellar ridge present, sometimes limited to portion just to sides of lateral ocelli; S-6 of male with median elevated area that broadens toward apex of sternum, forming a carina or spine at each side. *Exomalopsis* s.str.

—Vertex of female between ocellus and eye not excavated or only gently excavated; postocellar ridge absent; S-6 of male entirely flat. 3

3. Three submarginal cells; hamuli evenly spaced (Fig.2c); vertex of female between ocellus and eye gently excavated; pre-marginal line on T-1 of female depressed, forming transverse sulcus; apical fringe of T-5 and T-6 thin (sometimes dense), hairs short, their apices arched (Fig.1b); apical process of S-8 of male bearing a pair of arms; S-7 and S-8 of male without peg-like setae. *Phanomalopsis*

—Two submarginal cells; hamuli unevenly spaced (Fig.2a,b); vertex of female between ocellus and eye convex; pre-marginal line on T-1 of female not depressed; apical fringe of T-5 and T-6 dense, hairs long, their apices straight (Fig.1a); apical process of S-8 of male a single bare lobe; S-7 and S-8 of male with peg-like setae. *Diomalopsis*

LITERATURE CITED

- Michener, C. D. 1944. Comparative external morphology, phylogeny, and a classification of the bees (Hymenoptera). *Bulletin of the American Museum of Natural History* 82: 151-326.
- Michener, C. D. and J. S. Moure. 1957. A study of the classification of the more primitive non-parasitic anthophorine bees (Hymenoptera, Apoidea). *Bulletin of the American Museum of Natural History* 112: 395-452.
- Silveira, F. A. 1995. Phylogenetic relationships and classification of Exomalopsini with a new tribe Teratognathini (Hymenoptera: Apoidea). *The University of Kansas Science Bulletin* 55: 425-454.

New Species, Phylogenetic Placement, and Mammal Associations of *Loberopsyllus* (Languriidae: Xenoscelinae)¹

By

RICHARD A. B. LESCHEN² AND JAMES S. ASHE³

ABSTRACT The phylogenetic position of the genus *Loberopsyllus* Martinez and Barrera is considered, and two new species are described: *L. oculatus* n. sp. from southern Mexico and *L. explanatus* n. sp. from Costa Rica. A key to the species, an expanded definition of the genus that includes a free-living species, and a review of the biology and the cricetine rodent hosts are included. We hypothesize that phoresy on mammals arose subsequent to the origin of wing reduction in *Loberopsyllus*.

Keywords: Languriidae; Phylogenetic placement; Biology; Mammal hosts; New species; *Loberopsyllus*.

INTRODUCTION

Though many species of beetles are associated with mammal nests, there are only a few taxa that are phoretic on their mammal hosts. These are: platypssylline Leiodidae on beavers, mice, shrews and moles (Wood, 1965), amblyopinine Staphylinidae on rodents and opossums (Seevers, 1955; Ashe and Timm, 1987; Ashe et al., 1996), dung beetles on monkeys, wallabies, and sloths (Halffter and Matthews, 1966; Matthews, 1972; Ratcliffe, 1980; Lawrence and Britton, 1991), and the languriid genus *Loberopsyllus* on rodents (Martinez and Barrera, 1966; Barrera, 1969).

Byron Alexander would have been amazed if shown the extraordinary photographs of *Loberopsyllus* hanging like beads on the rump of a mouse (Barrera, 1969). So it is in his honor that we include this paper in his memorial volume, describe two new species and provide additional host information and comments on the biology of *Loberopsyllus*. Moreover, the discovery of a "free-living" species from montane Mexico provides fresh insight into character evolution and the systematic placement of *Loberopsyllus* in Languriidae.

Specimens are deposited in the following museums: Cornell University Insect Museum, Ithaca (CUIC); Field Museum of Natural History, Chicago (FMNH); Florida State Collection of Arthropods, Gainesville (FSCA); Montana State University Insect Collection, Bozeman (MONT); R. A. B. Leschen Collection (RALC); Snow Entomological Collection, KU Natural History Museum, University of Kansas, Lawrence (SEMC); T. Lanzewizki Collection, Marburg, Germany (TLAN); Universidad de Costa Rica, San Pedro (UCRS); Zoology Institute, Lund University,

Lund (LUND). Several inquiries to obtain type specimens of *L. traubi* and *L. halffteri* from Escuela Nacional de Ciencias Biológicas, Mexico City, Mexico, were unsuccessful; however, a paratype of *L. traubi* was located in FSCA.

ACKNOWLEDGMENTS

We thank Roy Danielsson (LUND), Mike Ivie (MONT), Horst Korn, Thomas Lanzewizki, Al Newton (FMNH), Paul Skelley (FSCA) and Quentin Wheeler (CUIC) for loans or gifts of material and Bob Timm (KUNHM, University of Kansas) for comments on mammal taxonomy.

Sara Taliaferro arranged the figures and Rod Hanley provided a review of the manuscript. Travel to FSCA for RABL was provided by NSF grant DEB-9222863.

Genus *Loberopsyllus* Martinez and Barrera

Loberopsyllus Martinez and Barrera, 1966: 11. Type species: *Loberopsyllus traubi* Martinez and Barrera, 1966: 11 (original designation).

Diagnosis.—Dorsal setae sparse; elytral punctuation confused; antennal insertions hidden in dorsal view; subocular glandular duct present; procoxal cavities closed externally (or nearly so); mesosternum and mesepimeron fused; broad single knob articulation of meso- and metasternum present; posterior condyles of metasternum well-developed; intercoxal process of ventrite I broad; elytral base with thick bead.

Description.—Length 1.40–2.94 mm. Body unicolorous, red-brown, dark brown, or black; glabrous or subglabrous; form parallel sided and moderately flattened to convex; dorsal setae sparsely distributed, simple, short, appressed. Dorsal and ventral surfaces with microsculpture. Punctuation of elytron fine and confused, scutellary striole absent. Head with margin of clypeus

¹ Contribution no. 3219 from the Snow Entomological Collection, Museum of Natural History, The University of Kansas.

² Manaaki Whenua Landcare Research, Private Bag 92 170, 120 Mt Albert Road, Auckland, NEW ZEALAND. E-mail: leschenr@landcare.ci.nz

³ Snow Entomological Collection, Division of Entomology, Natural History Museum, University of Kansas, Lawrence, KS 66045. E-mail: ashe@falcon.cc.ukans.edu

straight; vertexal line absent; frontoclypeal suture present; subgenal spine present; gular sutures absent; subocular glandular ducts present, arising from below eye, not extending into prothorax. Antennal insertion hidden in dorsal view; antennomeres of club relatively compact. Anterior portion of gula with a distinct, but not well-impressed, straight line. Eyes (Figs. 19, 20) present or absent; when present, with ocular setae. Supraocular line (Figs. 19, 20) and labral bead present, reduced or absent. Pronotum (Figs. 16–18) more or less parallel sided; anterior margin not invaginated; sides not explanate; lateral margins smooth; basal pronotal impressions present but poorly developed. Pronotal lateral bead without glandular ducts. Posterior margin of prosternal process emarginate. Procoxal cavities closed externally (or nearly so). Mesosternum and mesepimeron (Figs. 3, 11) fused; mesepimeron without pit. Mesosternum (Figs. 3, 11) with or without delimited coxal rests; with broad single knob articulation of the meso- and metasternum (Fig. 3). Metasternum (Figs. 3, 11) with median longitudinal line; subcoxal lines absent; posterior condyles of metasternum well-developed. Metendosternite reduced; anterior tendons and lateral processes absent. Abdominal ventrites I and II connate; ventrite I (Figs. 3, 11) with or without subcoxal lines, intercoxal process broad. Abdominal support structures present. Abdominal tergite VII hidden beneath elytra. Scutellum (Figs. 5, 12) poorly developed and slightly visible in dorsal view. Elytral base with thick bead; elytra fused in apterous forms. Hind wing reduced to narrow strip or completely absent; submedial fleck weakly developed in brachypterous form. Tibia more or less parallel-sided; outer margin without spines or crenulations; inner margin without tubercles. Tarsomeres slightly lobed below or strongly dilated with modified setae in apterous forms (pro- and mesotarsomeres more strongly dilated than metatarsomeres).

Male.—Without stridulatory file on head. Venter without glandular pores. Aedeagus (Figs. 7, 15) with two elongate struts. Spiculum ventrale asymmetrical (Fig. 13). Protarsomeres I–III with modified setae.

Female.—Without stridulatory file on head. Stylus inserted subapically on coxite (Figs. 6, 14). Spermatheca c-shaped.

Phylogenetic position.—We include *L. oculatus* in *Loberopsyllus* because it shares several diagnostic characters with other members; mainly, the mesosternum and mesepimeron fused, meso-metasternum with a single and broad internal articulation, posterior condyles of metasternum well developed, and basal margin of elytra with thick bead (Figs. 3, 11, 16–18). Other characters concordant with these are the reduced scutellum (Figs. 5, 12), microsculpture distinct on the body, and the dorsal surface glabrous or subglabrous.

The genus *Loberopsyllus* was originally described as a member of Cryptophagidae by Martinez and Barrera (1966) but was later transferred to Pharaxonothini (Xenoscelinae) of the Languriidae by Sen Gupta (1968), based on its externally open procoxal cavities, absence of subcoxal lines on ventrite I (Fig. 11), simple tarsomeres, and relatively short trochanters. Among these characters, that of the trochanter is based on relative length, which is not clearly defined, and is not considered further here. Though the remaining characters are certainly present in many Pharaxonothini, they are also present in some members of the subfamilies Cryptophilinae, Languriinae, and Setariolinae. This set of characters, therefore, does not conclusively confirm the placement of *Loberopsyllus* in Pharaxonothini. Moreover, the presence of subcoxal lines on ventrite I in *L. oculatus* (Fig. 3) is contradictory evidence for placement of the genus in Pharaxonothini (Sen Gupta and Crowson, 1971).

Two characters suggest that *Loberopsyllus* may be included either in Cryptophilinae or Toraminae. These taxa have a broad intercoxal process of ventrite I as shown in Figs. 3, 11. Outside of these subfamilies it is present in the genus *Paphezia* Zablotny and Leschen (1996) which is provisionally included in Xenoscelinae. Most Cryptophilinae and all Toraminae have a double knob articulation of the meso-metasternal junction (dicondylic), whereas all Xenoscelinae have a button-like articulation (monocondylic). However, some species of *Cryptophilus* Reitter and all *Xenoscelinus* Grouvelle (Cryptophilinae) lack condylic articulations that resemble the flattened or broad articulation present in *Loberopsyllus* (Figs. 3, 11).

The posterior condyles of the metasternum in *Loberopsyllus* (Figs. 3, 11) are homologous to areas that surround the socket for reception of the intercoxal process of ventrite I in other languriid taxa. These areas are typically less developed in other languriids but have the striations that are also present in *Loberopsyllus*. Posterior condyles are also well developed in *Xenoscelinus* and somewhat developed in the brachypterous genus *Lobosternum* Reitter (Toraminae; see Leschen, 1997).

We conclude that *Loberopsyllus* is doubtfully placed in Xenoscelinae based on contradictory evidence provided above. Because few cladograms exist for languriids (and the related erotylids) it is difficult to determine whether these characters are primitive or derived, and conclusive subfamilial placement of this genus must await further study.

Distribution.—*Loberopsyllus* is distributed in southern Mexico and Costa Rica.

Included species.—*Loberopsyllus halffteri* Martinez and Barrera, *L. explanatus* new species, *L. oculatus* new species, and *L. traubi* Martinez and Barrera.

Key to the Species of *Loberopsyllus*

- 1. Eye present, supraocular line present (Fig. 19), color black or dark brown. *L. oculatus*
- Eye absent, supraocular line reduced or absent (Fig. 20), color red-brown or brown. 2
- 2. Elytral margin distinctly explanate (Fig. 17). *L. explanatus*
- Elytral margin not explanate (Fig. 18). 3
- 3. Lateral pronotal margins moderately convex and widest at middle, length of aedeagal struts equal to that of tegmen. *L. traubi*
- Lateral pronotal margins parallel; length of aedeagal struts almost 2 times that of tegmen. *L. halffteri*.

Loberopsyllus oculatus, new species
(Figs. 1–7, 16, 19)

Diagnosis.—Eyes present; procoxal rests present; ventrite I with subcoxal lines; margin of elytron not explanate.

Description.—Length 1.90–2.08 mm (\bar{x} = 1.95, N = 8). Color of body brown (teneral), dark brown or black; antennae, mouthparts and legs dark or light brown. Average width of puncture 0.002 mm; punctuation moderately dense dorsally, moderately sparse ventrally, punctures separated by 1–3 diameters. Microsculpture of fine points present on head, pronotum and venter. Body setae fine and sparse, decumbent. Head moderately punctate, punctures of vertex separated by about 1–3 diameters; poorly-developed alveolate microsculpture on lateral margin behind eye. Eye (Fig. 19) poorly developed, coarsely faceted, 3–4 facets at greatest length. Supraocular line (Fig. 19) present. Antenna (Fig. 2) relatively long, extending to posterior margin of pronotum; relative lengths of antennomeres 1.6 : 2 : 1.3 : 1.3 : 1.3 : 1 : 1 : 1.3 : 1.6 : 2 : 2.3. Mandible (Fig. 1) with apex curved; mola spinose. Mentum carinate at middle (Fig. 4). Pronotum (Fig. 16) widest at middle, about 0.70 times as long as wide (pronotal length/maximum pronotal width = 0.69–0.70, \bar{x} = 0.70); depth = 0.40–0.58, \bar{x} = 0.51 mm; punctuation dense, punctures of disc separated by about 1–2 diameters. Prosternal process slightly emarginate at middle. Elytra about 1.39 times as long as wide (elytral length/maximum elytral width = 1.37–1.40, \bar{x} = 1.39) and 2.38 times as long as pronotum (elytral length/pronotal length = 2.39–2.41, \bar{x} = 2.40); glabrous, punctures not strongly impressed, separated by 1–3 diameters. Epipleuron distinct to level of ventrite IV. Mesosternum (Fig. 3) with procoxal rests; areolate punctures present. Mesonotum (Fig. 5) with moderately developed scutellum, fused solidly to sclerotized metanotum. Abdomen with internal support structures on ventrites II–IV; ventrite I

(Fig. 3) with subcoxal lines. Hind wing reduced to narrow strip, submedial fleck present. Tarsomeres not markedly dilated, without modified setae.

Male.—Internal sac and flagellum well developed, subequal in length to aedeagal struts (Fig. 7).

Female.—Gonocoxites setose along entire apical margin (Fig. 6).

Comments.—*Loberopsyllus oculatus* can easily be distinguished from the remaining species of *Loberopsyllus* by the characters listed in the diagnosis.

Etymology.—The name is derived from the Latin word *oculatus*, meaning having eyes.

Holotype.—Mexico, Oaxaca, 82 km N. Oaxaca City, hwy. 175, 2900 m, 29.IX.1990, leg R. Baranowski, sifting litter, mixed oak forest (LUND).

Paratypes.—Mexico, Oaxaca: 5 specimens, same data as holotype (LUND, RALC, SEMC); 3 specimens, same but 84 km S. Valle Nacional, 2850 m, 4.IX.1990, pine-oak boreal forest (LUND); 1 specimen (slide-mounted), same but 21 km N. Villa Diaz Ordaz, 3100m, 7.IX.1990, boreal forest (RALC); 2 specimens, 2 mi. S. Cerro Pelon, 8–9000 ft., 3.IX.1982, M. I. Ivie (MONT).

Loberopsyllus explanatus, new species
(Figs. 8–15, 17, 20)

Diagnosis.—Eyes absent; procoxal rests absent; ventrite I without subcoxal lines; margin of elytron explanate.

Description.—Length 2.53–2.94 mm (\bar{x} = 2.78, N = 10). Color of body red-brown; antennae, mouthparts and legs light red brown. Average width of puncture 0.002 mm; punctuation dense dorsally (not on elytra) and ventrally, punctures separated by 1–3 diameters. Alveolate microsculpture of points present on entire body, poorly developed on venter and elytra. Body setae short, fine and sparse. Head densely punctate. Eye absent (Fig. 20). Supraocular line (Fig. 20) absent or reduced to fine line (visible at high magnification). Antenna (Fig. 8) relatively long, extending to posterior margin of pronotum; relative lengths of antennomeres 2 : 2 : 1.8 : 1.4 : 1.4 : 1 : 1.2 : 1.2 : 2 : 2. Mandible (Fig. 9) with apex angulate; mola striate. Mentum broad at middle (Fig. 10). Pronotum (Fig. 17) widest at anterior, about 0.77 times as long as wide (pronotal length/maximum pronotal width = 0.72–0.73, \bar{x} = 0.72); depth = 0.70–0.85, \bar{x} = 0.78 mm; punctuation dense. Prosternal process emarginate at middle. Elytra about 1.44 times as long as wide (elytral length/maximum elytral width = 1.38–1.46, \bar{x} = 1.44) and 2.36 times as long as pronotum (elytral length/pronotal length = 1.71–2.50, \bar{x} = 2.36); subglabrous, rugose, punctures absent. Epipleuron distinct to level beyond ventrite V. Mesosternum (Fig. 11)

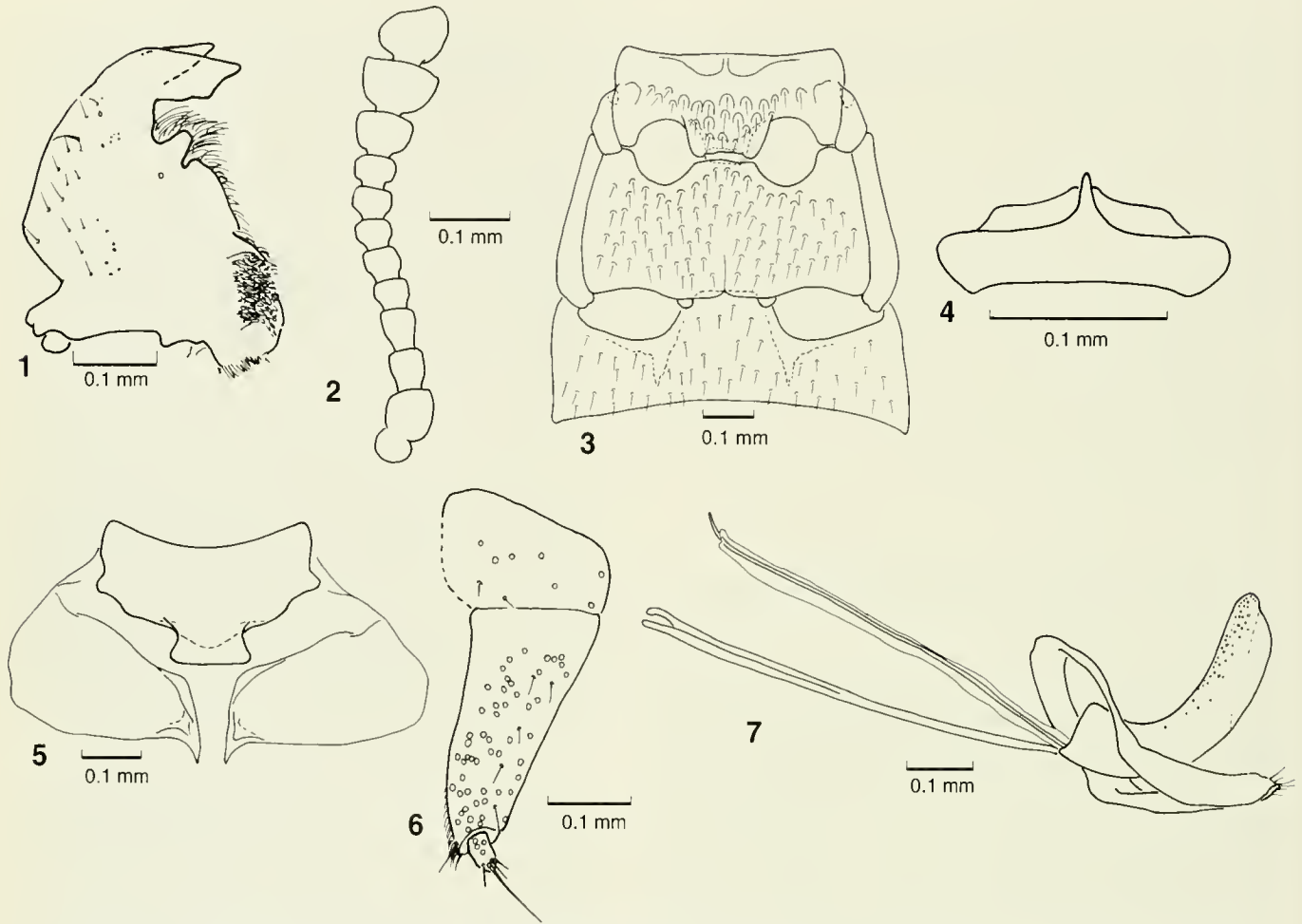

Figs. 1-7. *Loberopsyllus oculatus*, new species. 1-Left mandible, dorsal view. 2-Antenna. 3-Meso- and metasternites and ventrite I. 4-Mentum, ventral view. 5-Pteronotum. 6-Right gonocoxite, ventral view. 7-Aedeagus, left lateral view.

without procoxal rests; alveolate punctures absent. Mesonotum (Fig. 11) with poorly-developed scutellum, metanotum well sclerotized. Abdomen with internal support structures on ventrite IV; ventrite I (Fig. 11) without subcoxal lines. Without hind wing. Tarsomeres dilated, with modified setae.

Male.—Internal sac and flagellum not apparent (Fig. 15).

Female.—Gonocoxites setose at distal margin (Fig. 14).

Comments.—*L. explanatus* can be distinguished from other species by the explanate elytral margin and the well-developed microsculpture of the body.

Etymology.—The name is derived from the Latin combination of *ex-* and *planatus*, meaning out and level, respectively, for the form of the elytral margin.

Holotype.—Costa Rica, Cartago, 3 km E. Interamerican Hwy., km 99, Talamanca Cordillera, 9°35'N, 83°43'W, 2750 m, 1.VI.1994, T. Lanzewizki, ex: *Scotinomys xerampelinus* (SEMC).

Paratypes.—Costa Rica, Cartago: 2 specimens, same data as holotype (SEMC, TLAN); 7 specimens, same data as holotype except 4.V.1994 (FMNH, RALC, SEMC, TLAN); 13 specimens (3 slide-mounted), 1 km N. Vila Mills, III.1991, Horst Korn, ex: *Scotinomys xerampelinus* (RALC, SEMC, TLAN, UCRS); 4 specimens, Cerro de la Muerte, ex: *Bombus ephippiatus* nest, G. Chavarria, VIII.1993 (CUIC, SEMC).

BIOLOGY AND EVOLUTION OF *LOBEROPSYLLUS*

Loberopsyllus oculatus is free-living in leaf litter (see above), and the remaining species of the genus are associated with cricetine rodents. Host records for *Loberopsyllus* include *L. traubi* and *L. halffteri* on *Neotomodon alstoni* Merriam (Martinez and Barrera, 1966; Barrera, 1969), new records for *L. traubi* on *Nelsonia neotomodon* Merriam (Mexico: Cerro Tancitaro, 10,200 ft, 24.XII, FMNH, 28 specimens), and *L. explanatus* on *Scotinomys xerampelinus* (Bangs) (this paper). The record of *L. explanatus* from a nest of *Bombus ephippiatus* Say (see Chavarria, 1994) is probably

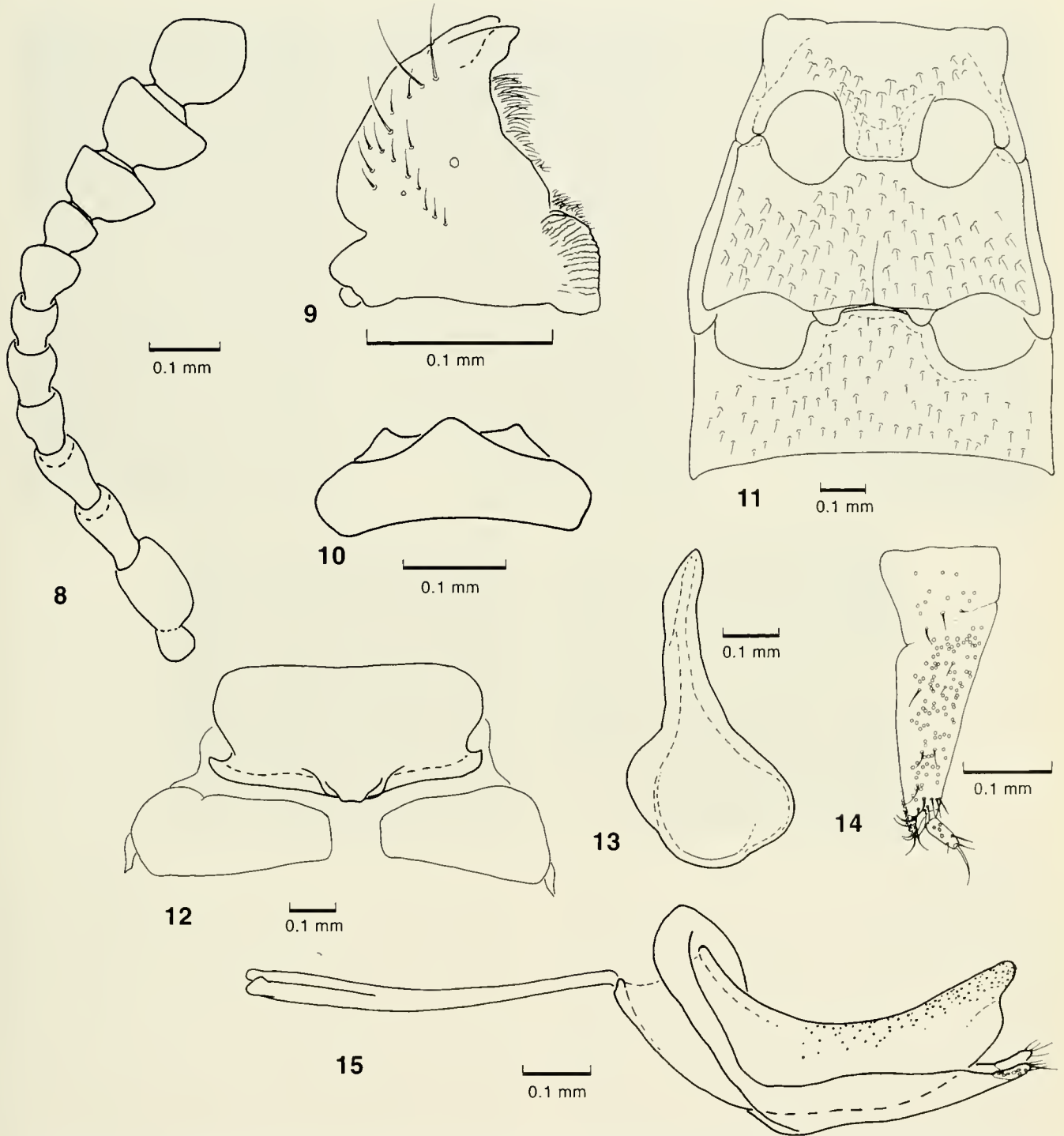

Figs. 8-15. *Loberopsyllus explanatus*, new species. 8-Antenna. 9-Left mandible, dorsal view. 10-Mentum, ventral view. 11-Meso- and metasternites and ventrite I. 12-Pteronotum. 13-Spiculum ventrale, dorsal view. 14-Right gonocoxite, ventral view. 15-Aedeagus, left lateral view.

related to a coincidental association of the bee with an abandoned rodent nest.

Subsequent to the description of *Loberopsyllus* by Martinez and Barrera (1966), Barrera (1969) published some extraordinary observations on host specificity, phoresy, and

diet of *L. traubi* on its host *N. alstoni*. Based on several field collections and a laboratory study, Barrera (1969) concluded that *L. traubi* is specific to *N. alstoni*. This pattern of host specificity also appears to be true for *L. explanatus* because the only specimens are from *S. xerampelinus*.



Figs. 16-20. 16-*Loberopsyllus oculatus*, new species, dorsal view of paratype. 17-*L. explanatus*, new species, dorsal view of holotype. 18-*L. traubi*, dorsal view. 19-*L. oculatus*, dorsolateral view of head. 20-*L. explanatus*, dorsolateral view of head.

Barrera (1969) also described and provided photographs of *L. traubi*, the beetles riding on the rump and thighs of its host rodent. Specimens of *L. explanatus* were also found in the fur near the rumps of the animals (T. Lanzewizki, in litt.), and it is clear that they are phoretic because most specimens were collected from rodent specimens caught in traps. Feeding of *L. traubi* was observed by Barrera (1969) on captured rodents; adults apparently groom the host's hair for dead skin and other organic debris. Dissections confirmed that the adult beetles feed on a variety of organic matter. The gut of one dissected specimen of *L. explanatus* from the series taken in a *Bombus* nest contained pollen.

Barrera (1969) concluded from his study that aptery and eyelessness are adaptations in *Loberopsyllus* to phoresy and an association with rodents. This conclusion, in part, is contradicted by the discovery of the free-living species

L. oculatus. Because of the brachypterous condition in *L. oculatus* and an apterous condition in the symbionts, it is possible that the free-living ancestor of *Loberopsyllus* was already flightless, and the mammal association evolved subsequently. Moreover, because most members of Languriidae are free-living and are capable of flight, it is likely that these two characters are primitive features in the family. A historical pattern of behavioral evolution including the following transformations would be consistent with this hypothesis: free-living, flighted → free-living, flightless → mammal association + phoresy. Eyelessness, strongly angulate mandibles, dilated tarsomeres, and characters associated with a more compact body (e.g., elytral fusion, loss of procoxal rests) may be correlated with mammal symbiosis. Additional observations on *Loberopsyllus* and its relatives will lead to a better understanding of the evolution of this group.

LITERATURE CITED

- Ashe, J. S. and R. M. Timm. 1987. Predation by and activity patterns of "parasitic" beetles of the genus *Amblyopinus* (Coleoptera: Staphylinidae). *Journal of Zoology*, London 212: 429-437.
- Ashe, J. S., R. M. Timm, and M. H. Gallardo. 1996. Systematics, distribution, and host specificity of *Edrabius* Fauvel (Insecta: Coleoptera: Staphylinidae). *Proceedings of the Entomological Society of Washington* 109: 731-743.
- Barrera, A. 1969. Notes on the behavior of *Loberopsyllus traubi*, a cucujoid beetle associated with the volcano mouse, *Neotomodon alstoni* in Mexico. *Proceedings of the Entomological Society of Washington* 71: 481-486.
- Chavarría, G. 1994. First neotropical mutualistic associations in bumblebee nests (Hymenoptera: Apidae). *Psyche* 101: 112-118.
- Halffter, G. and E.G. Matthews. 1966. The natural history of dung beetles of the subfamily Scarabaeinae (Coleoptera: Scarabaeidae). *Folia Entomologica Mexicana* 12-14: 1-312.
- Lawrence, J. F. and E. B. Britton. 1991. Coleoptera. Pp. 543-683, in CSIRO (ed.), *The Insects of Australia: a Textbook for Students and Researchers*, Vol. II. Second ed., Cornell University Press, Ithaca.
- Leschen, R. A. B. 1997. The *Empocryptus*-group (Languriidae: Toraminae): relationships and a new genus associated with a lepidopteran cocoon. *Coleopterists Bulletin* (in press).
- Martínez, A. and A. Barrera. 1966. Hallazgo de Cryptophagidae, anoftalmos y apteros, asociados a mamíferos (Ins., Coleopt.). *Ciencia (Mexico)* 25: 11-16.
- Matthews, E. G. 1972. A revision of the scarabaeine dung beetles of Australia. I. Tribe Onthophagini. *Australian Journal of Zoology Supplemental Series* 9: 1-330.
- Ratcliffe, B. C. 1980. New species of Coprini (Coleoptera: Scarabaeidae: Scarabaeinae) taken from the pelage of three-toed sloths (*Bradypus tridactylus* L.) (Edentata: Bradypodidae) in central Amazonia with a brief commentary on scarab-sloth relationships. *Coleopterists Bulletin* 34: 337-50.
- Sen Gupta, T. 1968. Review of the genera of the tribe Loberini (Coleoptera: Languriidae). *Breviora* 303: 1-27.
- Sen Gupta, T. and R. A. Crowson. 1971. A review of the classification of the family Languriidae (Coleoptera: Clavicornia) and the placement of Languriidae in the natural system of Clavicornia. *Memoirs of the Zoological Survey of India* 15: 1-42.
- Seevers, C. H. 1955. A revision of the tribe Amblyopinini: staphylinid beetles parasitic on mammals. *Fieldiana (Zoology)* 37: 211-264.
- Wood, D. M. 1965. Studies on the beetles *Leptinellus validus* (Horn) and *Platypsyllus castoris* Ritsema (Coleoptera: Leptinidae) from beaver. *Proceedings of the Entomological Society of Ontario*, 95: 33-63.
- Zablotny, J. E. & R.A.B. Leschen. 1996. Two new genera of flightless Languriidae (Coleoptera: Cucujoidea) from the Australo-Pacific. *Coleopterists Bulletin* 50: 382-390.

Floating and Nest Adoption in a Nesting Aggregation of the Mexican Opuntia Bee *Diadasia knabiana* (Apidae)

By

RUDOLF JANDER¹

ABSTRACT Females in nesting aggregations of the Mexican Opuntia Bee, *Diadasia knabiana*, adhere to one of two distinct behavioral strategies: Owners maintain individual nests and provision brood cells; floaters are not connected to a particular nest and search for orphaned nests which they adopt as future owners. Floaters occupy nests without owners present and wait for some time. If the owner returns from foraging, the floaters peacefully and ritually yield to the owner and continue searching for unoccupied nests. If no owner returns, floaters adopt the orphaned nests and start provisioning cells with pollen. Owners benefit from the temporary occupation of their nest by floaters because floaters keep out mutillid parasites. Thus the relation between owners and floaters is mutualistic. Based on scattered published observations, floating appears to be widespread among Apoidea (bees and sphecocomorph wasps) that nest in aggregations. It is suggested that one benefit of nesting in aggregations is the opportunity for bees without nests late in the season to adopt orphaned nests.

Keywords: Nesting aggregation; Floating; Solitary bee; Emphorini; *Diadasia*.

INTRODUCTION

Numerous species in all families of bees and sphecocomorph wasps (Apoidea) nest in aggregations (Michener, 1974; Brockmann and Dawkins, 1979). Such aggregations are most common in ground-nesting bees. This provokes the question: Why do nesting bees aggregate? A simple answer could be shortage of suitable nesting sites. Overall this answer is unsatisfactory because most of the time many seemingly equivalent sites remain unoccupied. Therefore, if there were benefits to aggregate nesting, we would have a more general and hence more satisfactory explanation for this socializing behavior. Against this theoretical background, I studied the behavioral activity in a nesting aggregation of the Mexican Opuntia Bee, *Diadasia knabiana* Ckll. Thereby became of particular relevance "floating", the search for orphaned nests by female bees without nests, and the adoption of orphaned nests by such floaters.

I shared with Byron Alexander the fascination for the macro-evolution of the higher Hymenoptera. This paper is the fifth in my series tracing the macro-evolution of various aspects of bee behavior (Jander and Jander, 1970; Jander, 1976; Jander and Jander, 1978; Jander, 1997). Since Byron had recently turned his interest to the genus *Diadasia*, it is particularly appropriate to dedicate this study to his memory.

ACKNOWLEDGMENTS

I thank R. Ayala and S. Bullock at Chamela for help in locating nesting aggregations of the Opuntia Bees and biological information about the bees and the opuntia on which they feed. S.L. Buchmann, G.W. Byers, R.W. Brooks, C.D. Michener, and an anonymous reviewer made valuable suggestions for improving the manuscript.

BEE, STUDY SITE, AND METHODS

Mexican Opuntia Bees *Diadasia knabiana* (Apidae, Apinae, Emphorini; Roig-Alsina and Michener, 1993) are prone to building their individual nests in dense aggregations. At least in the study area, this bee is monoleptic on the pollen and nectar of *Opuntia excelsa*, an arborescent cactus commonly found in the deciduous tropical Mexican forest. It blooms approximately from mid-June to early August, the beginning of the humid season (S. Bullock and R. Ayala, personal communication). The bees, somewhat less than two centimeters in length, nest in bare, more or less level ground in small to huge aggregations (hundreds of nests) during the blooming period of the opuntias. Dirt roads in the forests are excellent places for such aggregations. The continuously open, circular nest entrances are about 8 mm in diameter. They may be surrounded by tumuli of loose excavated soil and sometimes are topped by a turret, a brittle, short, sharply angled earthen tube

¹ Department of Entomology and Department of Ecology and Evolutionary Biology, University of Kansas, Lawrence, KS 66045.
E-mail: rjander@eagle.cc.ukans.edu

that opens horizontally. The foraging period of the bee during the morning hours until about noon coincides with the blooming of the host plant. Nothing has been published about the biology of this species, although there are studies on a few of the 45 or so congeners (Eickwort et al., 1977; Linsley and MacSwain, 1952, 1957, 1958; Linsley et al., 1952; Neff et al., 1982; Ordway, 1984; Schlising, 1972, and others).

I investigated these bees during three weeks from mid July to early August 1986 at the Biological Station "Chamela" (Universidad Nacional Autonoma de Mexico)(19°39' N, 105°03' W) close to the Pacific coast, south of Puerto Vallarta, Jalisco. The aggregation studied was located 900 meters from the Station headquarters along a dirt road called the "Camino Antiguo Sur". The aggregation comprised several hundred nests scattered over roughly an elliptical area of 10 × 2 m. The study period was late in the bees' flight season. No males were seen, but pollen-collecting was still under way.

Much of the time spent near the nesting aggregation was used for observing and classifying the bees' action patterns, and establishing the contexts in which these action patterns occurred. Special attention was paid to search flights and to the peculiar exploration flights, which are known as a synapomorphic trait of brood-caring aculeate Hymenoptera (Jander, 1997). The observational information was supplemented by experimental interventions, which will be described below together with the specific questions to be answered.

OWNERS AND FLOATERS

In the aggregation area I observed two sharply distinct groups of bees with conspicuously different behavior, nest owners and floaters.

Owners kept returning to one particular burrow, which they defended against other bees that tried to enter. Owners regularly shuttled between foraging sites and their nest, typically returning with scopal loads of cactus pollen.

Floaters were not associated with one particular nest and they never carried pollen. Instead, floaters kept searching for orphaned nests. "Floating," in the behavioral literature, usually refers in territorial species to non-aggressive individuals without territory that are wandering through the habitat in search of orphaned territories (Wilson, 1975; examples: the butterfly *Pararge aegeria*, Davies, 1978, or lizards, Stamps, 1983). Analogous criteria hold for floaters in hymenopteran nesting aggregations, except that the defended area or "territory" includes only the nesting burrow proper and not the whole home range (e.g., Jang et al., 1996, or Wuellner, 1997).

FLIGHT PATTERNS ABOVE NESTING SITES

Most of the observable behaviors at nesting sites during the late foraging season were flight patterns. In addition, there were rare agonistic encounters between bees, there was expelling of mutillid wasps from the nests, there was some excavation of soil, or bees were sitting in their nest entrances in a head up (pre-departure) or head down (plugging and protecting) position.

The three major categories of near-nest flight patterns that are typical for aculeate Hymenoptera (Jander, 1997) could also be distinguished in this species: 1) local search flights, 2) local exploration flights and 3) distal shuttle flights (homing and leaving) of foragers. Local search flights and local exploration flights comprised two distinct sub-categories: forward-flying in alternating loops, and lateral oscillations while facing an object.

1) All searching within the nesting aggregation was for nest entrances. The great majority of searchers were floaters. They constituted a whirling, humming cloud over the nesting area, spreading slightly beyond it. The mean cruising height of these bees was 14 cm (SD = ±3 cm, n = 100), as determined by reading from a vertical measuring stick to the nearest centimeter. In still air the search paths formed irregular, left-right-alternating loops with the linear distance between turns being mostly less than 0.5 m as estimated against a grid of 1 m squares laid over the ground. With increasing, steady winds the looping flights changed more and more into up-wind meander-flights, irregularly interrupted by compensating down-wind dashes.

Once a searching bee was near the entrance of a nest that she did not own, the close-range searching of floaters and of temporarily disoriented nest owners was strikingly different. Floaters, with rare exceptions, immediately entered the burrow for an inspection visit. Owners, instead, preferred focal search flights.

The focal search (inspection) flights of aculeate Hymenoptera typically consist of horizontal, laterally oscillating movements while facing the object of interest (Jander, 1997). In the Mexican *Opuntia* Bees, the amplitude of the focal search oscillations spanned up to some 10 cm. Most of the focal search flights observed were followed by forward-flying searching loops.

Occasionally after inspecting, lost owners briefly entered foreign burrows, but rarely penetrated more than a body length, then backed out again. More variable were inspection visits by floaters. In all cases when the owner was known to be inside the nest, floaters backed out quickly. Whenever they stayed inside, no other bee was there. In a number of instances they did not stay in unoccupied nests, but I have no record of the frequency ratio between staying in or leaving unoccupied nests.

2) Exploration flights are fixed action patterns for learning that are only found in the aculeate Hymenoptera (Jander, 1997). Wasps and bees perform exploration flights near locations to which they intend to return in the future. During exploration flights enough local features of the environment are learned to support pinpoint return orientation (Collett, 1992; Zeil, 1996; Jander, 1997). Consistent with these functions, bees and wasps invariably perform exploration flights prior to their very first departure and oftentimes prior to their first departure for the day. In addition, any major disturbances of nest environments that impede nest finding are usually followed by an exploration flight prior to the next departure. In the past the exploration flights of the aculeate Hymenoptera had commonly, but less distinctively, been called "orientation flights"; another modern label is "learning flights" (Zeil, 1996).

These general rules, defining the contexts in which exploration flights tend to occur, were confirmed for the Mexican *Opuntia* Bees. Casual observations established that there were exploration flights prior to the first departure of the day, but rarely later. In provisioning bees that no longer explored at departure, I could provoke exploration by the following alteration of the nest environment: While provisioning bees were away from home I placed a rectangular piece of yellow cardboard (20 × 25 cm) with its long side exactly beside their nest entrances. Of 32 different individuals treated this way 29 were clearly disturbed when homing. Instead of the few seconds of standard homing search above the ground they searched for at least a minute and frequently inspected other nest entrances until they finally found their own nests. On their next departure 20 of the 29 disturbed bees performed an exploration flight, which strikingly contrasts with their pre-disturbance departures, none of which included an exploration flight. None of the three bees that homed undisturbed by the yellow cardboard performed an exploration flight on subsequent departures.

In the Mexican *Opuntia* Bee, near-nest exploration is composed of three distinct behaviors: a) pre-exploratory behavior, b) focal exploration, and c) peripheral exploration, which shall be described in some detail. Focal exploration and peripheral exploration flights are integral components of the exploration flights found in all brood-caring aculeate Hymenoptera (Jander, 1997).

a) Pre-exploratory behavior, or "watching," was behavior inside the nest entrance. Prior to intensive exploration, the bee first faces out of the nest entrance for a prolonged period of time as if watching. The face is at ground level and occasionally rotates to and fro in the horizontal plane, which is about the bee's longitudinal axis if the entrance opens vertically and about its dorso-ventral axis if

the nest opens horizontally. Whenever some motion or a shadow passes over the watching bee, she retreats more or less deeply down the burrow, depending on the magnitude of stimulation. In a number of cases I saw the pre-exploring bee leave the nest entrance, take a few steps, turn around and re-enter, head first.

b) Focal exploration invariably is the first phase of a complete exploration flight, seen immediately upon the bee's emergence from the nest entrance. The focally exploring bee is oriented, almost "glued", with her longitudinal axis toward the nest entrance, flying as if attached to a pivot with lateral, arcuate oscillations a few centimeters above ground. Such facing arcs may cover up to a full circle when the nest entrance opens without turret on horizontal unobstructed ground. If the turret is intact or the bare nest entrance opens more or less horizontally on a slope, focal exploration is restricted to the horizontal sector facing the entrance. The typical duration of a focal exploration flight is about a second.

c) Peripheral exploration is preceded by focal exploration most of the time; alternatively, bees sometimes begin peripheral exploration immediately after take-off. In peripheral exploration the forward flying bees alternated between lefthand and right-hand turns, many of them covering more than 180 degrees, thus causing crossovers of trajectories. Hence, an apt description is figure-eight looping. Initial exploratory looping often appeared to be as irregular (random) as in search flights, but all turned into more systematic, figure-eight looping, with smooth and sharp turns alternating. During looping the bee faced away from the nest entrance most of the time. As the exploratory looping unwound, the diameters of the loops kept increasing while the bee was gaining height. The long axes of the final, large figure-eight loops at the aggregation under study were always parallel to the road, that is, stayed within the open space of the forest aisle. The largest loops spanned up to ten meters and more. After a few seconds of exploratory looping, the bees took off straight, gradually gaining more height and disappearing from sight.

3) Pure shuttle flights for foraging, marked by distinct flight patterns at departure and arrival, are performed by well established owners. Floaters, too, obviously must sometimes leave the aggregation, at least for foraging, but this was not studied.

Departing established foragers leave the nest entrance expeditiously with a straight, gradually ascending flight. Since most of the bees, on taking off from the nest, face in a direction different from the subsequent straight departure flight, a correction is necessary. This is done immediately after take-off by means of a departure turn, sometimes covering more than a semicircle, but never more than a full circle (several hundred observations). The departure

turn starts sharply and then smoothly grades into the straight departure flight while the bee continually gains height.

Foragers returned from their journeys after an average span of nine minutes ($SD = \pm 3$ min, $n = 36$), in the aggregation under study. The arriving forager—after an unobserved descent—approached its nest with irregular loops, which proved, except for their brevity, to be indistinguishable from unambiguous search loops. Indeed, when I first observed these bees, still ignorant about the distinction between floaters and owners, I mistook the searching and nest-entering floaters for owners returning without pollen. Because of this similarity in form and context, I refer to these flight maneuvers as the homing search loops. Hundreds of homing search flights invariably terminated within a few seconds with the foraging bee entering its own nest, unless the environment had been altered. Homing errors can readily be recognized because owners only inspect (by inspection flights and inspection visits) foreign nests and never spend time inside them as they do in their own nests; furthermore, they do not unload pollen in foreign nests. Once close over a horizontal nest entrance the homing bee stops flight and then drops into the entrance, disappearing quickly from sight. Inside her own nest, it takes the bee an average of one minute and 18 seconds ($SD \pm 14$ s, $n=65$) to unload and come out again for the next foraging excursion.

INTERACTIONS AMONG FLOATERS, OWNERS AND MUTILLID PARASITES.

Owners, floaters, and at least two species of unidentified mutillid wasps searched for and entered nest entrances in the nesting aggregation studied. Thus three types of encounters between individuals of conflicting interest were inevitable. This is how they typically unfolded:

1) Floater-owner interactions were the most common of the three types. Floaters searched for nests all day long, not just during the foraging period in the morning hours. When I paid prolonged attention to individual floaters they were seen entering most but not all nests encountered; they always entered without a preceding inspection flight. Thereafter they usually left immediately, but sometimes they stayed. Staying never occurred when the owner was known to be inside (35 cases recorded); however, floaters often left, even when the owner was known to be absent.

All floaters that were observed to stay inside a nest were sooner or later met by the returning owners (more than 200 observations). In virtually all these encounters the returning owner entered and immediately backed out again to assume a looping "waiting flight" for a few seconds. During these waiting periods the floaters usually voluntarily left the owners' nests. If they failed to yield at

first, the owner repeated the routine, sometimes several times, until the floater finally left. Only twice did I witness a brief venter-to-venter grappling fight outside the nest between the emerging floater and the returning owner. In both cases the floater emerged head first and the owner—identified by its pollen load—won the fight.

At the end of July, I systematically recorded for 200 returning foragers whether they encountered floaters in their nest. They did so in 90 (45%) of these returns. One-third (31 of 90) of above floaters, caught "red-handed" by returning owners, left the nest head first, the others tail first. Since there was a permanent cloud of searching floaters during this recording period, I estimated that the total number of floaters was roughly that of the owners. A week later the relative number of floaters had precipitously declined but was not systematically sampled.

Given the above numbers, together with the average foraging trip duration of nine minutes, and assuming random arrival of floaters to vacant nests, the following intranidal behavior sequence of floaters is inferred. Upon entering the foreign nest head first, a floater stayed in the shaft of the nest, head down, for an average of six minutes. Thereafter it turned around and waited head upward for the owner to return. If the underground nest architecture was like that of *Diadasia opuntiae* (Ordway, 1984), the best place to turn around was in a terminal chamber at the lower end of the shaft.

Among the 90 yielding floaters mentioned, 89 instantly resumed floating, i.e., searching for and entering foreign nests. Only one re-entered the very nest from which it had just been "expelled" while the owner was still inside, but immediately left again. One of the yielding floaters left the aggregation in the same direction that most of the foragers used to depart for collecting pollen. Many additional, casually observed floaters invariably resumed searching after yielding.

I individually color-marked five floaters. One day later three were still floating. Three days later I found only two, one still floating, the having taken over a nest. She was busy provisioning with pollen, an activity that she continued for several more days until I left. Floating is thus a highly sustained activity; yet ultimately a floater may become an owner, a behavioral transition that will be described below.

2) Owner-owner interactions were never observed, except when I intervened. Specifically, I never saw more than one bee with a pollen load returning to a particular burrow.

3) Mutillids searched for nests in many ways similar to the way floaters searched for them, except that they walked on the ground. Their search paths had the shapes

of irregular alternating turns. On encountering a nest entrance, they briefly stopped, "inspected" with their antennae, then entered or continued searching. The basis for such decisions could not be clarified. There was no evidence that they discovered nest entrances other than by stumbling upon them.

Returning owners encountering a mutillid in their burrow chase or push it out prior to unloading their pollen load. This is done either head first or backward. In the latter case I noticed twice that the owner stayed for a few seconds near the entrance, tightly plugging the shaft with its curled abdomen, prior to moving again down the nest. Besides "pushing out" and "obstructing re-entry," no other visible interactions between bees and mutillids occurred. All expelled mutillids immediately continued random searching, obviating the need for special sustained nest defense measures after such an expulsion. Never did I see any of the some hundred of searching mutillids wait at a nest entrance for an owner to depart so that they could then safely intrude, an obviously simple and optimal strategy. Also, I never saw any interactions between mutillids and bees outside the nests.

Returning owners encountered in their nests either a floater, or a mutillid or neither. In one hundred returns of owners to nests with a floater inside, not a single mutillid was expelled by the returning owner. On the other hand, among two hundred returns tallied when no floater was inside, the owners expelled a mutillid in twelve (6%) instances. This frequency difference in the presence or absence of mutillids inside the nest, contingent on floater presence, is significant at $p < 2\%$ (Fischer's two-tailed exact probability test; null hypothesis: encountering mutillids in the nest at the same rate irrespective of the presence or absence of a floater). From this analysis I infer that floaters in burrows at least reduce, if not even prevent visits by mutillids.

4) As for floater-mutillid interactions, I have only two direct observations. In both instances the floater was already inside the nest, and the intruding mutillid was immediately pushed out by the floater. The interesting question of whether floaters expel mutillids that had entered a nest before them, or whether they avoid entering such a nest, is still open.

TRANSFORMATION OF FLOATERS INTO OWNERS

Observation of the undisturbed aggregation established that floaters do not usurp the nests that are owned, yet they may become owners. Hence, the most likely scenario is the takeover of orphaned nests by floaters. To test this hypothesis I removed five owners from their nests and

watched the re-occupation of the nests. Within one day all five orphaned nests were re-owned by pollen-provisioning owners; all—with little doubt—had been floaters. In three cases I actually observed a floater finding and then occupying an orphaned nest. An abbreviated protocol of such a dramatic behavioral transformation is instructive:

Time	Events
8:45	I remove the owner.
9:50	A floater finds the nest and enters.
9:55	Faces out of the entrance.
10:04	Walks out of the nest twice, a few straight centimeters, turns around and re-enters, head first.
10:05	Exits for first exploration flight followed by straight departure.
10:06	Returns to the nest and, almost immediately, exits for another exploration flight, followed by straight departure.
10:11	Returns to the nest, occasionally facing out of entrance and retreating.
10:23	Pushes out another floater that had briefly entered.
10:27	Departure without preceding exploration.
10:44	Return with a pollen load, thus expressing full-owner behavior.
	End of systematic record.

Occasional observations showed that this new owner kept provisioning for at least another hour.

This sequence of floater-owner transition is considered typical, based on the close similarity of three such sequences observed. All three owners-in-the-making performed two exploration flights prior to leaving the nesting area for their first pollen-collecting trip. Interestingly, after two of the three first exploration flights the returning bees made one homing mistake. They alighted at another, nearby nest entrance, briefly inspected, continued with a brief homing search flight and then found and entered their own new nest. After their second exploration flight all three bees returned errorless to their nests. Since exploration flights last only a few seconds, this is remarkably fast learning of the local homing cues; the term "snapshot learning" is apt and adds another connotation to the recently developed hypothesis of a snapshot (picture like) memory for orientation cues in bees (Cartwright and Collett, 1983; Wehner et al., 1996).

DISCUSSION

The issues to be discussed are 1) the fitness costs and benefits of nesting in aggregations, 2) the evolution of com-

munal nesting, and 3) homology relations of some of the behaviors observed.

1) Nesting in aggregations certainly has its costs. Because of shared exploitation, the average flight distances to resources must be greater than for bees that disperse their nest sites. Proximity is bound to increase the chances of aggressive interactions about nests and the resources therein. Such aggression has been observed, for instance, in the megachilid bees *Hoplitis anthocopoides* and *Chalicodoma pyrenaica* (Fabre, 1879; Eickwort, 1975) and in the sphecids wasps *Sphex speciosus* and *Sphex ichneumoneus* (Lin, 1963; Brockmann and Dawkins, 1979). Proximity of nests facilitates intraspecific parasitism and stealing or robbing provisions such as prey in sphecids or pollen in bees (Brockmann, 1993; Hogendoorn and Velthuis, 1993). Overall, intraspecific parasitism is widespread among apoid and vespoid Hymenoptera (Field, 1992). Densities of heterospecific parasites in nesting aggregations can be high and may cause the destruction of whole aggregations (Lin, 1964; Batra, 1965; Michener, 1966a and 1974; Wuellner, 1997). Finally, it appears plausible that predators can decimate a population much more easily if the individuals are aggregated rather than dispersed.

In spite of all these substantial costs, many species of bees, sphecids wasps, and vespoid wasps keep nesting in aggregations. There is no avoiding the conclusion that aggregate nesting confers some fitness benefits. However, until recently only hypothetical benefits for aggregate nesting could be offered (Wcislo and Cane, 1996). Analogical reasoning is not helpful either. Many vertebrates, especially 85% of the seabirds, breed in aggregations ("colonially"), and as explanation, again, only hypothetical fitness benefits can be offered (Danchin and Wagner, 1997).

Now we can recognize an unambiguous fitness benefit from aggregate nesting in *Diadasia knabiana*: the opportunity for adopting orphaned nests. This benefit certainly offsets some and perhaps all of the costs incurred by aggregate nesting. Nest adoption must be of critical importance for individuals that lose their nest burrows or that emerge late in the breeding season. By adopting an orphaned burrow, instead of building a new one, much time and energy is saved that is then available for provisioning the brood. There may be individuals that cannot reproduce at all, unless they have the opportunity to adopt an orphaned nest. In an aggregation floaters can inspect in a short time a large number of nests in order to find one that is orphaned. Discovering an orphaned nest when nests are widely dispersed would either require an inordinate amount of time or might never succeed.

Floating or floating-like behavior occurs in various species of the redefined family of the Apidae (Roig-Alsina and Michener, 1993). In addition to *Diadasia knabiana*, it

occurs in *Diadasia diminuta* (Eickwort et al. , 1977), in *Diadasia afflicta* (Neff et al. , 1982), in *Anthophora bombooides* (Brooks, 1983) and in *Centris segregata* (Coville et al. 1983). In the Halictidae (redefined in Alexander and Michener, 1995) there is conspicuous floating behavior in aggregations of *Dieunomia triangulifera* (Wuellner, 1997), and in the Colletidae (Alexander and Michener, 1995) this is so in *Crawfordapis luctuosa* (Jang et al. , 1996). Finally, in the Sphecidae there is evidence for floating behavior in *Cerceris zonata* (Elliott et al. , 1981a), *Cerceris watlingensis* (Elliott et al. , 1981b) and in *Lindenius* (Miller and Kurczewski, 1973). With this evidence from various species, floating may well be a behavioral characteristic to be expected in all nesting aggregations of bees and sphecomorph wasps.

This widespread, if not universal occurrence of floating in such aggregations is a plausible indicator that adoption of orphaned nests and the associated fitness benefit is common. However, currently there is little direct evidence showing that adoption of orphaned nests is as common as apparent floating. There is the possibility, as pointed out by Wuellner (1997), that what appears to be floating might instead in some species be searching for conspecific nests to be parasitized. Intraspecific parasitism is indeed common in apooids and vespooids (Field, 1992).

The most surprising observation was the high tolerance owners showed towards floaters encountered in their nests. The typical peacefulness of the yielding ritual is more indicative of a collaborative or mutualistic relationship rather than of a competitive relationship. Indeed, there are the benefits documented above for both the floater and the owner. The floater might find an orphaned nest and the owner receives protection against parasitic mutillids and perhaps other parasites. An additional benefit for the owner might be a sort of life insurance. Should she prematurely die, the floater takes over the care of the nest and perhaps increases the survival chances of the previous owner's brood. An analogous benefit for colony members of vespid colonies (*Ropalidia marginata*) was suggested by Gadagkar (1990,1996) and dubbed "assured fitness return." Given the plausible assumption that parasite protection is a byproduct of a floater's waiting in an owners nest, the symbiotic relationships between floaters and owners can be regarded as "byproduct mutualism" (Dugatkin, 1997)

Not surprising is the absence of aggression of the floater toward the owner of the nest. Winning a fight would mean full access to a valuable resource, the nest. However, the general rule tells us that in such asymmetrical contests the owners usually win fights (Huntingford and Turner, 1987). Thus the floater in the owner's nest is better off by being peaceful and yielding.

2) Investigators interested in the evolution of social life in insects have paid most attention to the evolution of

eusociality, the most advanced and most complex state of sociality (e.g., Michener, 1974, 1985; Gadagkar, 1994; Crozier and Pamilo, 1996; Bourke, 1997). Less analyzed are the very first evolutionary steps towards rudimentary sociality as they are expressed in the transformation series from solitary nesting to aggregated nesting and then to communal nesting (burrow sharing). Lin and Michener (1972) were the first to focus on this earliest phase of social evolution, thereby recognizing mutualism as an important driving force. Corroborating this idea are the clear-cut mutualistic benefits of fitness established for the members of the aggregations of Mexican *Opuntia* Bees. Importantly, this is an example of rudimentary, mutualistic pro-social behavior among solitary bees. It is easy to envision this pro-social behavior to be a precursor ("pre-adaptation") to communal nesting for the following reasons. Communal nesting requires mutual tolerance, which is seen in the floater-owner interactions. Furthermore, the floaters share a burrow with the owners, though for a very short time. However, should the owner not return, the floater is instantly ready to adopt the burrow for its own reproduction. Surely, not much has to change from this state of affairs to evolve communal breeding. Indeed, R. Brooks observed (California, Imperial County) in *Diadasia lutzii* that two or three provisioning females sometimes shared a single burrow (personal communication). Another ground-nesting apid bee known for burrow sharing among provisioning females is *Exomalopsis solani* (Michener, 1966b).

3) The similarity of action pattern between searching and exploring is worth mentioning. Both activities have two similar constituents. Focal exploration flights with lateral oscillatory movements while facing the nest entrance by nest owners are similar to focal inspection flights while searching for nests in disoriented nest owners and occasionally in floaters. Peripheral figure-eight search by exploring owners is similar to the looping flight patterns of floaters searching for nest entrances. These similarities further corroborate the conclusion that the exploration flights of the aculeate Hymenoptera are homologous with search flights from which they originally evolved (Jander, 1997).

Sitting in the nest entrance prior to exploration by owners appears homologous with sitting in the nest entrance by floaters while they wait for the nest owner to return and with nest-entrance guarding in many species of burrow-nesting bees.

LITERATURE CITED

- Alexander, B., and C. D. Michener 1995. Phylogenetic studies of the families of short-tongued bees (Hymenoptera: Apoidea). The University of Kansas Science Bulletin 55: 377–424.
- Batra, S. W. T. 1965. Organisms associated with *Lasioglossum zephyrum* (Hymenoptera: Halictidae). Journal of the Kansas Entomological Society 38: 367–389.
- Bourke, A. F. G. 1997. Sociality and kin selection in insects. Pp. 203–227 in J. R. Krebs and N. B. Davies (eds.), *Behavioural Ecology. An Evolutionary Approach*. Blackwell Science: Oxford.
- Brockmann, H. J. 1993. Parasitizing conspecifics: comparison between Hymenoptera and birds. *Trends in Ecology and Evolution* 8: 2–3.
- Brockmann, H. J., and R. Dawkins. 1979. Joint nesting in a digger wasp as an evolutionarily stable preadaptation to social life. *Behaviour* 71: 201–245.
- Brooks, R. W. 1983. Systematics and bionomics of *Anthophora*: the *bomboides* group and species groups of the New World (Hymenoptera: Apoidea, Anthophoridae). University of California Publications in Entomology 98: 1–88.
- Cartwright, B. A., and T. S. Collett. 1983. Landmark orientation in bees. Experiments and models. *Journal of Comparative Physiology* 151: 521–543.
- Collett, T. S. 1992. Landmark learning and guidance in insects. *Philosophical Transactions of the Royal Society, London* 337B: 295–303.
- Coville, R. E., G. W. Frankie, and S. B. Vinson 1983. Nests of *Centris segregata* (Hymenoptera: Anthophoridae) with a review of the nesting habits of the genus. *Journal of the Kansas Entomological Society* 56: 109–122.
- Crozier, R. H., and P. Pamilo 1996. *Evolution of Social Insect Colonies. Sex Allocation and Kin Selection*. Oxford University Press: New York. 306 PP.
- Danchin, E., and R. H. Wagner 1997. The evolution of coloniality: the emergence of new perspectives. *Trends in Ecology and Evolution*. 12: 342–347.
- Davies, N. B. 1978. Territorial defense in the speckled wood butterfly (*Pararge aegeria*): The resident always wins. *Animal Behaviour* 26: 138–147.
- Dugatkin, L. A. 1997. *Cooperation among Animals: An Evolutionary Perspective*. Oxford University press: New York.
- Eickwort, G. C. 1975. Gregarious nesting of the mason bee *Hoplites anthocopoides* and the evolution of parasitism and sociality among megachilid bees. *Evolution* 29: 142–150.
- Eickwort, G. C., K. R. Eickwort, and E. G. Linsley 1977. Observations on nest aggregations of the bees *Diadasia olivacea* and *D. diminuta* (Hymenoptera: Anthophoridae). *Journal of the Kansas Entomological Society* 50: 1–17.
- Elliott, N. B., W. M. Elliott, and P. Salbert 1981. Nesting behavior of *Cerceris zonata*. *Annals of the Entomological Society of America*. 74: 127–129.
- Elliott, N. B., T. Shlotzhauer, and W. M. Elliott 1981. Nest use by females of the presocial wasp *Cerceris watlingensis*. *Annals of the Entomological Society of America* 79: 994–998.
- Fabre, J. H. 1879. *Souvenirs Entomologiques*. Vol. II. Paris.
- Field, J. 1992. Intraspecific parasitism as alternative reproductive strategy in nest-building wasps and bees. *Biological Reviews* 67: 99–126.
- Gadagkar, R. 1990. Evolution of eusociality: the advantage of assured fitness returns. *Philosophical Transactions of the Royal Society, London* 329B: 17–25.
- Gadagkar, R. 1994. Why the definition of eusociality is not helpful to understand its evolution and what should be done about it. *Oikos* 70: 485–487.
- Gadagkar, R. 1996. The evolution of eusociality, including a review of the social status of *Ropalidia marginata*. Pp. 248–271 in S. Turillazzi, and M. J. West-Eberhard (eds.) *Natural History and Evolution of Paper-Wasps*. Oxford University Press: New York.
- Hogendoorn, K., and H. H. W. Velthuis 1993. The sociality of *Xylocopa pubescens*: does a helper really help? *Behavioral Ecology and Sociobiology* 32: 247–257.

- Huntingford, F. A., and A. K. Turner 1987. *Animal Conflict*. Chapman and Hall: New York. 460 pp.
- Jander, R. 1976. Grooming and the pollen manipulation in bees (Apoidea). The nature and evolution of the movement involving the foreleg. *Physiological Entomology* 1: 179–194.
- Jander, R. 1997. Macroeolution of a fixed action pattern for learning. The exploration flight of bees and wasps. Pp. 79–99 in G. Greenberg and E. Tobach (eds), *Comparative Psychology of Invertebrates. The Field and Laboratory Study of Insect Behavior*. Garland Publishing: New York.
- Jander, R., and U. Jander 1970. Über die Phylogenie der Geotaxis innerhalb der Bienen (Apoidea). *Zeitschrift für vergleichende Physiologie* 66: 355–368.
- Jander, R., and U. Jander 1978. Wing grooming in bees (Apoidea) and the evolution of wing grooming in insects. *Journal of the Kansas Entomological Society* 51: 653–665.
- Jang, Y., C. T. Wuellner, and C. T. Scott 1996. Floating and fidelity in nest visitation of *Crawfordapis luctuosa* (Hymenoptera: Colletidae). *Journal of Insect Behavior* 9: 493–504.
- Lin, N. 1963. Observations of suspected density dependent fighting between females of the cicada killer wasp *Sphectus speciosus*. *Bulletin of the Brooklyn Entomological Society* 58: 121–123.
- Lin, N. 1964. Increased parasite pressure as a major factor in the evolution of social behavior in halictine bees. *Insecta Socialia* 11: 187–192.
- Lin, N., and C. D. Michener. 1972. Evolution of sociality in insects. *The Quarterly Review of Biology* 47: 131–159.
- Linsley, E. G., and J. W. MacSwain 1952. Notes on some effects of parasitism upon a small population of *Diadasia bituberculata* (Cresson). *Pan-Pacific Entomologist* 28: 131–135.
- Linsley, E. G., and J. W. MacSwain 1957. The nesting habits, flower relationships, and parasites of some North American species of *Diadasia* (Hymenoptera:Anthophoridae). *Wasman Journal of Biology* 15: 199–235.
- Linsley, E. G., and J. W. MacSwain 1958. The significance of floral constancy among bees of the genus *Diadasia* (Hymenoptera: Anthophoridae). *Evolution* 12: 219–223.
- Linsley, E. G., J. W. MacSwain, and R. E. Smith 1995. The bionomics of *Diadasia consociata* Timberlake and some biological relationships of emporine and anthophorine bees (Hymenoptera, Anthophorinae). *University of California Publications in Entomology* 9: 267–290.
- Michener, C. D. 1966a. The bionomics of a primitively social bee, *Lasioglossum versatum* (Hymenoptera: Halictidae). *Journal of the Kansas Entomological Society* 39: 193–217.
- Michener, C. D. 1966b. Evidence of cooperative provisioning of cells in *Exomalopsis*. *Journal of the Kansas Entomological Society* 39: 315–317.
- Michener, C. D. 1974. *The Social Behavior of the Bees*. Harvard University Press: Cambridge, Mass. 404 pp.
- Michener, C. D. 1985. From solitary to eusocial: need there be a series of intervening species? *Fortschritte der Zoologie* 31: 245–305.
- Miller, R. C., and F. E. Kurczweski 1973. Intraspecific interactions in aggregations of *Lindeni* (Hymenoptera, Sphecidae, Crabroninae). *Insecta Socialia* 20: 365–378.
- Neff, J. L., B. B. Simpson, and J. L. Dorr 1982. The nesting biology of *Diadasia afflicta* Cress. (Hymenoptera: Anthophoridae). *Journal of the Kansas Entomological Society* 55: 499–518.
- Ordway, E. 1984. Aspects of the nesting behavior and nest structure of *Diadasia opuntiae* Ckll. (Hymenoptera: Anthophoridae). *Journal of the Kansas Entomological Society* 57: 216–230.
- Roig-Alsina, A., and C. D. Michener. 1993. Studies of the phylogeny and classification of long-tongued bees (Hymenoptera: Apoidea). *The University of Kansas Science Bulletin* 55: 123–173.
- Schlisling, R. A. 1972. Foraging and nest provisioning behavior of the oligolectic bee *Diadasia bituberculata* (Hymenoptera: Anthophoridae). *Pan-Pacific Entomologist* 8: 175–188.
- Stamps, J. 1983. Territoriality and the defense of predator-refugia in juvenile lizards. *Animal Behaviour* 31: 857–870.
- Wcislo, W. T., and J. H. Cane 1996. Resources utilization by solitary bees (Hymenoptera: Apoidea), and exploitation of their stored food by natural enemies. *Annual Reviews of Entomology* 41: 257–286.
- Wehner, R., B. Michel, and P. Aronson 1996. Visual navigation in insects: Coupling egocentric and geocentric information. *Journal of Experimental Biology* 199: 129–140.
- Wilson, E. O. 1975. *Sociobiology: The New Synthesis*. Harvard University Press: Cambridge, MA. 997 pp.
- Wuellner, C. T. 1997. Nest site preference and alternative reproductive strategies of solitary bee *Dieunomia triangulifera*, and behavior of its natural enemy, *Triepolus distinctus* (Hymenoptera: Apoidea). *Dissertation, University of Kansas*.
- Zeil, H. 1996. The control of optic flow during learning flights. *Journal of comparative Physiology* 180A: 25–37.

Novel Use of Walking Trails by the Amazonian Bumble Bee, *Bombus transversalis* (Hymenoptera: Apidae)

By

SYDNEY A. CAMERON,^{1,2,4} JAMES B. WHITFIELD,² MILES COHEN,³ AND NATALIE THORP³

ABSTRACT During field observations of the Amazonian bumble bee, *Bombus transversalis* (Olivier), in southeastern Peru near the Rio Tambopata, we observed the use of walking trails by a subset of colony members. Workers involved in construction and maintenance of the external nest envelope follow ground trails that lead outward from the nest, gleaning and scraping root hairs and other leaf material from the substrate. Trail workers cut leaves into pieces approximately 2 cm² and push them behind them in the direction of the nest with their front legs. Trails radiated from the nest in opposite directions, extending 2–3 m into the forest. At least 20 workers patrolled the trails, collecting materials along them and at apparent collection sites at the ends of the trails. Observations of marked individuals indicate that workers are (at least temporarily) constant to one trail at a time.

Keywords: *Bombus transversalis*; Bumble bees; Trails; Pheromones.

INTRODUCTION

Ants are the preeminent ground-dwellers among social Hymenoptera. Their biomass dominates the world's tropical rain forest ecosystems, an ecological success rivaled only by the distantly related termites (Isoptera) (Wilson, 1971). Ants and termites alone among the social insects are flightless (only dispersing reproductives are winged) and both have developed walking trails as transport highways for the coordinated collection of food and other colony resources (Hölldobler & Wilson, 1990). Thus trail-use has evolved at least twice among ground-dwelling social insects, providing a striking example of evolutionary convergence in behavior. The other two groups of highly social insects, within the apid bees and vespid wasps, principally use flight for foraging. They are not known to use ground trails for locating colony resources (Wilson, 1971; Michener, 1974), although some species of stingless bees are known to follow scent marks or aerial odor trails during flight (Wille, 1983; Nieh & Roubik, 1995). Thus we were surprised in May 1995 to find the use of terrestrial trails by the Amazonian bumble bee, *Bombus* (*Fervidobombus*) *transversalis* (Olivier), whose trails resemble the ground trails of ants.

Bombus transversalis occurs only in tropical lowland rain forest habitat of the Amazon Basin. Unlike many bumble bees, which typically build their nests below ground in abandoned rodent burrows or other pre-exist-

ing cavities, *B. transversalis* constructs its nests on the surface of the soil in terra firme (never flooded) forest, on well-drained sites. Nests are fashioned from leaves, twigs and rootlets interwoven into a conical, protective nest canopy (Dias, 1958; Olesen, 1989), which bears a resemblance to some ant colonies (e.g., *Pheidole* or *Formica*) (Hölldobler & Wilson, 1990). Moreover, the colonies can become unusually large, producing several thousand offspring (Dias, 1958), whereas most *Bombus* colonies produce only a few hundred individuals. Although other species within the subgenus *Fervidobombus* nest on the soil surface and can form large colonies (Michener and LaBerge, 1954; Sakagami, 1976), only *B. transversalis* is known to construct a nest canopy of thatched leaves and twigs. Only two previous studies have described the nests of *B. transversalis*, that of Dias (1958) from the Belém region of Brasil, and that of Olesen (1989) based on a colony found in Ecuador along the Rio Napo. Those studies focused on brood counts and descriptions of nest architecture, hence details of nesting biology and foraging activity of this species are unknown or obscure.

Here we describe the characteristics of trail-making in this species, observed during a study of the nesting biology and foraging behavior of a colony located in Peru along the Rio Tambopata (12°50'S, 69°17'W), approximately 280 m above sea level. Cameron and Whitfield (1996) provided a brief initial report on trail-making behavior by this colony of *B. transversalis*. In this report we expand upon the find-

¹ Department of Biological Sciences, University of Arkansas, Fayetteville, AR 72701. E-mail: scameron@comp.uark.edu

² Department of Entomology, University of Arkansas, Fayetteville, AR 72701.

³ Explorer's Inn, Tambopata Nature Reserve, Madre de Dios, PERU.

⁴ Address for correspondence.



Fig. 1. Nest canopy of *B. transversalis* near main trail at the Tambopata Preserve. A few bees can be spotted on the exterior of the canopy. This photo was taken from a vantage point to the left of and closer to the nest than that of Fig. 2.

ings presented in that paper, with new details of the nest structure and worker population, the rates and proportions of workers performing various tasks, and temporal and spatial patterns of trail construction and use.

ACKNOWLEDGMENTS

We especially thank T'ai Roulston for alerting us to the existence of colonies of *B. transversalis* at the Tambopata Reserve; Natalie Thorp actually located the study nest. Christina Forster's help was invaluable in collecting some of the foraging and trail activity data. We thank the management of Explorer's Inn and the Tambopata Reserve for allowing us to study the colony. We acknowledge the support of a National Science Foundation grant (GER-94-50117) to SAC. This paper is dedicated to the memory of Byron Alexander, for his boundless enthusiasm and meticulous attention to detail in the fields of bee and wasp natural history.

METHODS

Two colonies were found along marked trails on the Tambopata Nature Reserve (see Pearson and Dressler, 1985

for studies of orchid bees along the same trail system). These are the first colonies of *B. transversalis* reported and observed in Peru. One colony was active and the other was inactive but had been vigorous seven months earlier (September 1994, pers. comm. T'ai Roulston) when it was first discovered. The active colony was located along "Main Trail", just past km 2.1 on the northwest side of the trail. It was situated near a stilt-rooted *Cecropia* tree on a slight rise about one m from the trail (Fig. 1). The inactive nest was located along "Swamp Trail" at approximately km 2.16. Each nest was located within approximately 100 meters of standing water. Our observations on trail use and foraging activity pertain only to the active colony.

We first observed the colony for ten days, from 20–30 May 1995, during the early part of the dry (lower water) season. Subsequently, we made periodic observations over the following months until the colony's demise during the rainy season in November 1995. We first described the nest dimensions, worker population size, and the location and length of two trails leading from the nest, apparently

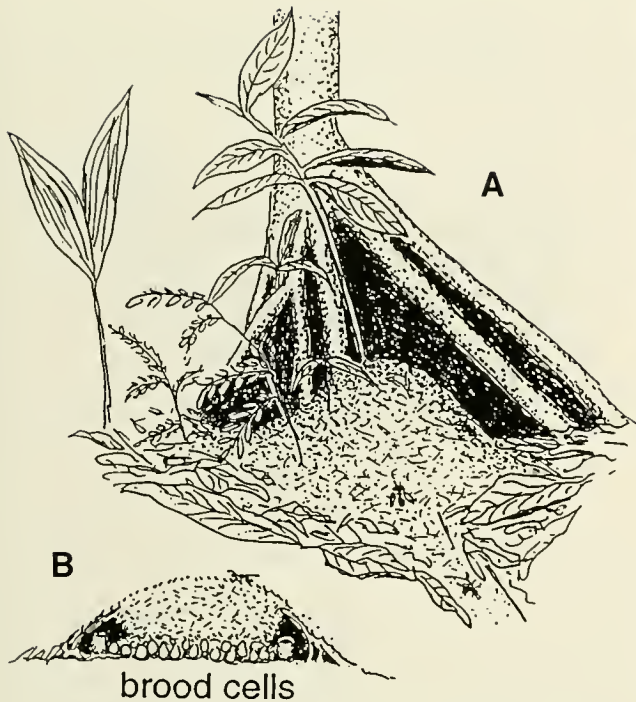

Fig. 2. Diagrams of *Bombus transversalis* nest located near *Cecropia* tree in forest site, (A) the external cone-shaped nest canopy of the colony, and (B) cross-sectional drawing of the brood comb beneath nest canopy.

cleared by a subset of workers (Cameron & Whitfield, 1996). Subsequently we uncovered the nest at the end of the initial 10 days of behavioral observations to determine the size and structure of the colony. All workers, including foragers, were collected alive to obtain adult and brood counts and then released back into the reassembled nest, which the workers quickly repaired.

Females were captured with aerial nets and given a distinctive color mark on the thoracic dorsum, abdomen, and/or wing using paint pens (Faber Castell). Different colors were assigned to workers engaged in (1) nest construction and trail-following at the eastern side of the colony, (2) nest construction and trail-following at the western side of the colony, and (3) colony defense (guards determined by their propensity to attack any intruder within three to four m of the nest). Foragers were easily distinguishable from other workers by their swift, direct flight in and out of the nest entrance, and they required no marking. Approximately 50 workers were marked.

During the first five days of observation, we made behavioral scans of workers outside the nest. For ten-minute periods, once each hour from sunrise to sunset, we counted all individuals active on the nest canopy, walking along trails, and flying in and out of the nest to collect food (foragers). We also marked bees that attacked us dur-



Fig. 3. Photograph of the brood comb and honey pots around the perimeter.

ing these observations, regarding them as guard bees. Thereafter, we continued periodically to mark workers and make similar behavioral scans until November 1995, at which time the colony expired and was excavated a second time.

Species identification of the bees was confirmed by comparison with descriptions from Milliron (1973). Voucher specimens are deposited in the Arthropod Museum, University of Arkansas, Fayetteville.

RESULTS

COLONY SIZE AND NEST ARCHITECTURE

When observations began in late May 1995, the colony was in a pre-reproductive, rapid growth stage of development (see Cameron, 1989, for a description of bumble bee colony stages and behavioral castes), containing one queen and 338 workers, not including foragers away from the nest during the excavation (perhaps 10–20 workers).

The tightly woven thatching of the cone-shaped nest canopy (Fig. 2A, basal dimensions = 86.36 cm east/west, 68.58 cm north/south; 35.56 cm high; thickness of thatching = 5.1 cm) protected the brood and food-storage vessels (Fig. 2B), as well as the queen and workers engaged in nursing activities. The brood comb, in a slight depression (4–5 cm), was entirely dry and free of fungal decay or wax moths. Extremely hard, dry mud mixed with straw (5 cm thick) formed an inner band around the brood clump, lining the inner circumference of the thatched canopy at its base. The composition of this inner lining resembled a primitive clay pot. The oval-shaped comb (Fig. 3) measured 28 cm across the long axis and 20.3 cm along the short. From 26–30 wax honey pots were positioned around the perimeter of the brood comb (Fig. 3); none of these contained pollen. Some of the honey pots were unusually large

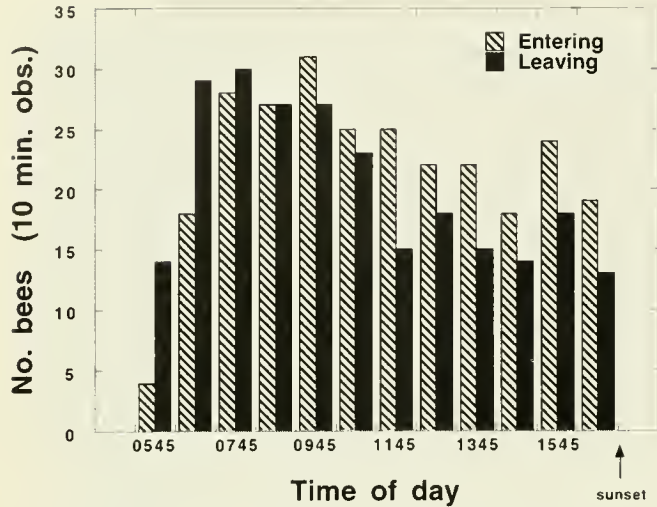

Fig. 4. Worker traffic in and out of the colony on 24 May 1995. Each bar shows traffic during a 10 min interval every hour.

(3.5 cm tall \times 1.3 cm diam.) and all were dark in color with a pebbled, coarse texture. The position, shape and texture of the honey pots suggested that they were not modified from pupal cocoons, but rather were constructed entirely of wax and perhaps sand or soil (judging from the pebbled appearance) for the sole function of storing nectar. Pollen pots, on the other hand, were modified from pupal cocoons and dispersed throughout the brood comb. New brood existed atop the older comb, consisting of the remains of empty pupal cocoons. The thickness of the entire brood clump was approximately 8.5 cm.

To minimize the amount of time the brood was exposed to the open air, we counted all brood cells on only one-half of the comb. Because egg cells, larval cells, and pupal cocoons appeared evenly distributed throughout the comb, it is reasonable to multiply this count by two to obtain an estimate of the entire brood. Thus one-half of the comb contained six egg cells, 75–80 larvae distributed among four discrete larval clumps, and 40–50 worker-sized pupal cocoons. There were no gyne cocoons, easily distinguishable from worker or male cocoons by their larger size (2 \times –3 \times).

FORAGING ACTIVITY

Specialized workers foraged for nectar and pollen throughout the nearly 12-h period of light, beginning at sunrise (0530) and continuing until sunset (1700) (Fig. 4). During peak activity (0745–0945), foragers flew in and out of the nest at an average rate of six bees per minute.

TRAIL-FOLLOWING

Females were seen following one another, often in tandem, along a cleared ground-trail that extended approxi-

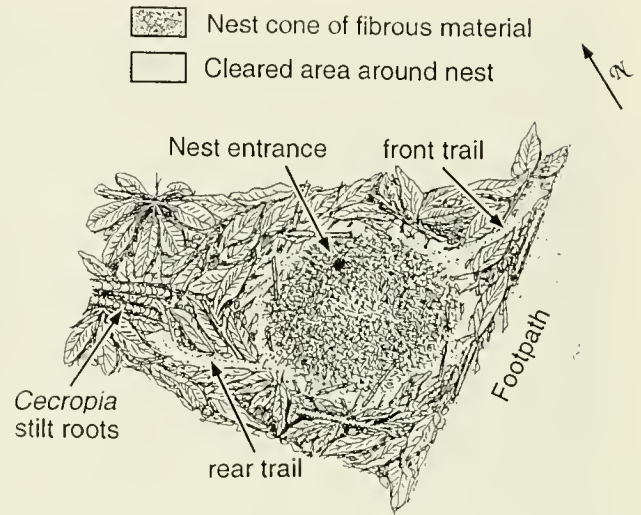

Fig. 5. Simplified diagram of nest with two trails, front and rear.

mately 1.6 m from the nest canopy 280° WNW (rear trail, Fig. 5) to a spot beneath some fallen *Cecropia* leaves. This was the only area around the nest that was cleared of vegetation. Along this worn path, from one to several workers at a time were seen walking onto the trail from the nest canopy, where previously they had been engaged in canopy construction (teasing and smoothing the matted leafy outer covering of the nest with their mandibles). These workers initially drew our attention by their jabbing head movements along the soil surface and their tendency to move aside pieces of vegetation encountered in their path from the nest to the trail terminus beneath *Cecropia* leaves. At the end of the trail, workers disappeared beneath the fallen leaves, where they often remained for a period of five minutes or more, emerging from their hidden position to fly back to the nest canopy (sometimes they walked back) and begin smoothing and teasing the outer layer of nest thatching. From under the pile of dry leaves a crackling noise was audible as workers seemed to be cutting up pieces of leaves and rootlets for use in canopy construction. Because we did not wish to disturb the colony during the observations, we did not collect workers returning to the nest canopy to determine what, if anything, they carried back.

It was difficult to get closer than 1–2 m from the nest without some of the guards seeing us and attacking, necessitating protective clothing. During an attack, a large fraction of the workers on the nest canopy were disturbed, flying around in the immediate vicinity of the colony or attacking the intruder. It took five to ten minutes for the colony to return to normal after such an attack.

These preliminary observations on trail-following behavior on the west side of the nest led us to observe the

Trail Construction

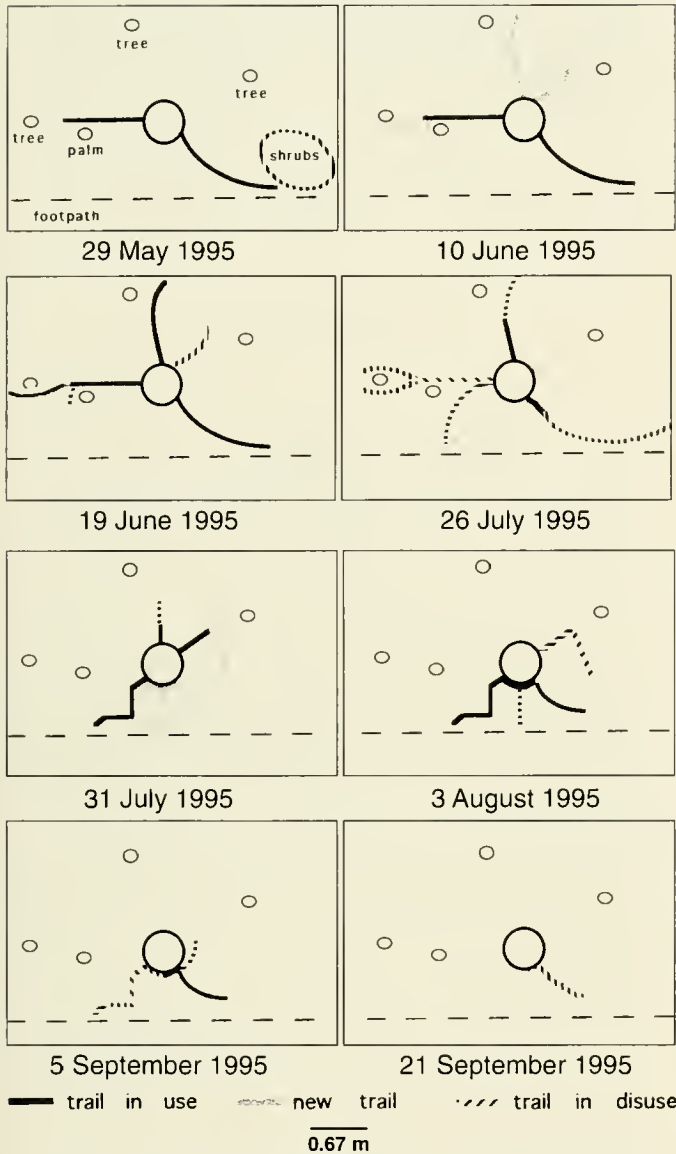

Fig. 6. Temporal patterns of *B. transversalis* trail construction and use during May–November 1995.

bees on the opposite side of the nest canopy to the east (120° ENE), the side containing the single entrance to the colony (front trail, Fig. 5). Here, a second trail extended about 2 m straight out from the nest along the forest floor (Fig. 1). Like the western trail (rear trail, Fig. 5), this one was clear of vegetation and terminated underneath dense leaves. Individual workers followed this trail to the end, spent several minutes under the dense leaf material, then flew back to the canopy to begin working on the thatching. The behavior of the bees along this front trail was indistinguishable from that of the bees along the rear trail. No trails were yet seen north or south of the nest.

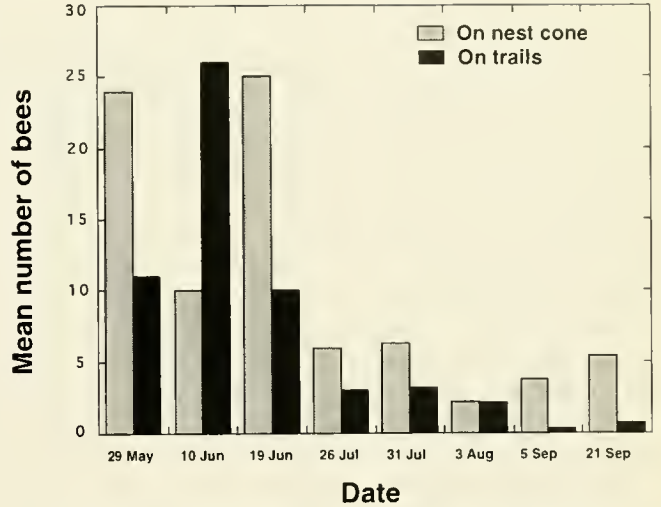

Fig. 7. Numbers of workers engaged in patrolling the nest cone, and in trail construction and use at intervals during the colony cycle.

TRAIL SPECIFICITY

To determine whether workers were constant to individual trails, from 10–15 individuals were collected along each trail and marked with a distinct color (silver for the rear (W) trail, green for the front (E)). Several hours later only the silver-marked workers were seen along the rear trail and only the green along the front trail, suggesting that the two trails were used by different groups. This same distribution of marked workers was observed the following day. After two days however, several of the silver workers were seen along the front trail.

TEMPORAL PATTERNS OF TRAIL CONSTRUCTION AND USE

During the initial 10-day observation period only two trails were visible (Fig. 6, 29 May). In subsequent weeks and months additional trails were constructed, and some trails were eventually abandoned (Fig. 6). New trails appeared to be actively maintained as outbound bees (perhaps a different group from those collecting leaves for the nest canopy) removed any fragments of leaves or twigs from the trails as they encountered them. When we dropped litter onto a trail, it was discovered and removed in five minutes or less by workers, who pushed it sideways off the trail using their mandibles, or scraped it backwards (under the body) toward the nest canopy using the forelegs.

A significant, but changing, proportion of workers was visible either on the nest canopy or on the trails (Fig. 7). Workers on the canopy appeared to be building and maintaining the elaborate thatching, using materials brought to them by the trail bees. Construction and use of the trails declined considerably in the later months of the colony cycle (Figs. 6, 7).

DISCUSSION

Our observations of the behavior of trail use in *Bombus transversalis* suggest that trails may provide a direct, unobstructed and reliable route to a source of material for nest canopy construction. Such a canopy is found in no other species of *Bombus*. Its design is doubtless an important feature for living in moist tropical rain forest (for an account of nest site selection by another neotropical species of *Fervidobombus* found in lowland forest see Janzen, 1971). It is a stiff mass of leaves, rootlets, and fibers woven into an aerated waterproof cone 10–15 cm thick. Collection of nest thatching is made efficient by the spatial arrangement of trails. The bees minimized the overlap in collection of leaf litter on the forest floor by constructing the first two trails on opposite sides of the nest (almost 180° apart), then adding subsequent trails at maximally distant positions relative to the first (90° and 45°, respectively). By maintaining the trails, which terminate in patches of dense leaf-litter, workers have a continuing supply of building materials to incorporate into the expanding canopy (Cameron and Whitfield, 1996).

An additional function of the trails may be in colony defense. The colony must protect its investment, especially the queen and new brood, from enemies that threaten to overrun the nest. Trails allow workers to monitor the vicinity of the colony, not only for vertebrate intruders but, more importantly, for predatory ants. Evidence in support of this idea was provided when we later penetrated the nest envelope to photograph the brood cells within. We collected all of the external and many of the internal bees beforehand. Within ten minutes of the disturbance, ants found their way into the colony and began stealing stored honey. We assume the ants were able to enter the colony because the normal, aggressive defense system of the guards and trail bees had been breached. The intact colony was able to successfully repel an attack by army ants (*Eciton*) on the morning of 19 October.

We suggest that the terrestrial trails may be considered a physical extension of the colony, analogous to the home ranges of many ants (Hölldobler and Wilson, 1990). Such home ranges are commonly marked with territorial or colony recognition pheromones (Hölldobler and Wilson, 1990). It is not yet known if pheromones are used to scent-mark trails to assist in orientation or to demarcate a colony boundary. Bumble bees apply marking pheromones in at least three contexts: (a) departing foragers deposit a pheromone from the Dufour's gland when passing between the brood cells and the nest entrance (Cederberg, 1977, 1990; Tengö et al., 1991; Oldham et al., 1994); (b) foragers scent-mark the location and vicinity of rewarding food sources (Cameron, 1981; Schmitt & Bertsch, 1990;

Schmitt, 1990); and (c) males mark leaves, twigs, and tree trunks when establishing mating territories (Svensson & Bergström, 1977). Nest entrance pheromones serve as species-specific and colony-specific recognition signals (Cederberg, 1977, 1990). If the trails cleared by *B. transversalis* are marked by Dufour's gland secretions, this would represent a simple evolutionary extension of the nest-marking function to that of home-range marking, as occurs in ants (Hölldobler & Wilson, 1990).

LITERATURE CITED

- Cameron, S. A. 1981. Chemical signals in bumble bee foraging. *Behavioral Ecology and Sociobiology* 9: 257–260.
- Cameron, S. A. 1989. Temporal patterns of division of labor among workers in the primitively eusocial bumble bee, *Bombus grisecollis* (Hymenoptera: Apidae). *Ethology* 80: 137–151.
- Cameron, S. A. and J. B. Whitfield. 1996. Use of walking trails by bees. *Nature* 379: 125.
- Cederberg, B. 1977. Evidence for trail marking in *Bombus terrestris* workers (Hymenoptera, Apidae). *Zoon* 5: 143–146.
- Cederberg, B. 1990. Pheromones and behavior in bumble bees and cuckoo bumble bees. M.Sc. Thesis, Uppsala University, Sweden.
- Dias, D. 1958. Contribuição para o conhecimento da bionomia de *Bombus incarum* Franklin da Amazônia (Hymenoptera: Bombidae). *Revista Brasileira Entomologia* 8: 1–20. [in Portuguese].
- Hölldobler, B. and E. O. Wilson. 1990. *The Ants*. Harvard University Press, Cambridge, MA.
- Janzen, D. H. 1971. The ecological significance of an arboreal nest of *Bombus pullatus* in Costa Rica. *Journal of the Kansas Entomological Society* 44: 210–216.
- Michener, 1974. *The Social Behavior of the Bees*. Harvard University Press, Cambridge, MA.
- Michener, C. D. and W. E. LaBerge. 1954. A large *Bombus* nest from Mexico. *Psyche* 61: 63–67.
- Milliron, H. E. 1973. A monograph of the Western Hemisphere bumblebees (Hymenoptera: Apidae; Bombinae). II. The genus *Megabombus* subgenus *Megabombus*. *Memoirs of the Entomological Society of Canada* 89: 81–237.
- Nieh, J.C. and D.W. Roubik. 1995. A stingless bee (*Melipona panamica*) indicates food location without using a scent trail. *Behavioral Ecology and Sociobiology* 37: 63–70.
- Oldham, N. J., J. Billen, and E. D. Morgan. 1994. On the similarity of the Dufour gland secretion and the cuticular hydrocarbons of some bumblebees. *Physiological Entomology* 19: 115–123.
- Oleson, J. M. 1989. Behaviour and nest structure of the Amazonian *Bombus transversalis* in Ecuador. *Journal of Tropical Ecology* 5: 243–246.
- Pearson, D. L. and R. L. Dressler. 1985. Two-year study of male orchid bee (Hymenoptera: Apidae: Euglossini) attraction to chemical baits in lowland south-eastern Peru. *Journal of Tropical Ecology* 1: 37–54.
- Sakagami, S. F. 1976. Specific differences in the bionomic characters of bumblebees. A comparative review. *Journal of the Faculty of Science, Hokkaido University Series VI, Zoology* 20: 390–447.
- Schmitt, U. 1990. Hydrocarbons in tarsal glands of *Bombus terrestris*. *Experientia* 46: 1080–1082.
- Schmitt, U. and A. Bertsch. 1990. Do foraging bumblebees scent-mark food sources and does it matter? *Oecologia* 82: 137–144.

- Svensson, B. and G. Bergström. 1977. Volatile marking secretion from the labial glands of north European *Pyrobombus* D.T. males (Hymenoptera, Apidae). *Insectes Sociaux* 24: 212-224.
- Tengö, J., A. Hefetz, A. Bertsch, U. Schmitt, G. Lübke and W. Francke. 1991. Species specificity and complexity of Dufour's gland secretion of bumble bees. *Comparative Biochemistry and Physiology* 99B: 641-646.
- Wille, A. 1983. Biology of the stingless bees. *Annual Review of Entomology* 28: 41-64.
- Wilson, E. O. 1971. *The Insect Societies*. Belknap Press of Harvard Univ. Press, Cambridge, MA.

Influence of Three Factors on African Honey Bee Swarms' Preference for Bait Hives in Mexico

By

CARLOS H. VERGARA¹

ABSTRACT The influence of three factors on the capture rate of Africanized honey bees swarms was measured using bait hives. High bait hives (3–4 m above ground), away from apiaries and lured with pheromone captured more swarms than bait hives with any other factor combination. Height is the most important factor in attracting swarms. Occupation of bait hives away from apiaries seems to be dependent on feral colony density in the area. The effect of Nasonov pheromone lures was not clear.

Keywords: Nasonov pheromone; African honey bees; Bait hives; Mexico.

INTRODUCTION

African honeybees (AHB) have moved in 40 years from Brazil to Southern United States, occupying South and Central America, and colonizing also subtropical areas of Argentina, where they have been found up to the 39° South latitude parallel (Dietz & Vergara, 1995; Rubink et al., 1996; Loper, 1997).

The use of bait hives as a means of attracting and capturing swarms has been a common beekeeping practice for a long time. It has been shown that European honey bees (EHB) swarms exercise considerable care when selecting a nest site and that they prefer to occupy cavities of 40 liters over cavity sizes of 10 or 100 liters (Seeley, 1982), and also prefer 31 liters over 13.5 liters cavities (Schmidt & Hurley, 1995). In a series of experiments AHB showed a preference for cavity sizes of 40–80 l over cavity sizes of 10–20 l (Rinderer et al., 1981; Rinderer, et al., 1982), but Schmidt & Hurley (1995) found that 13.5 l cavities are best for trapping AHB swarms, and that they are rejected by most EHB swarms. It is also known that EHB swarms prefer bait hives located at 3 m above ground level, or higher, although bait hives placed at least 2 m over ground level are acceptable and more attractive than bait hives placed below 2 m (Seeley, 1982; Seeley and Morse, 1978). However, height preference has not been investigated using AHB. Synthetic Nasonov gland pheromone components have been found to increase the attractiveness of bait hives to EHB (reviewed by Witherell, 1985; Schmidt & Thoenes, 1992), and their use as a lure for bait hives has become very frequent in programs directed to control or monitor swarm populations.

The effect of the proximity of artificial congregations of colonies (i.e., bee yards) on bait hive attractiveness has not been investigated for any race of honeybees. However, it is known that reproductive swarms of EHB apparently

prefer nest sites near the parent colony (Seeley & Morse, 1977). According to Taylor & Otis (1978), uneven rates of colonization by AHB in South America could be explained because the colonizing swarms show a tendency to be attracted to the vicinity of established colonies. African bees in Zambia are often attracted to bait hives placed near resident feral colonies, and, according to Silberrad (1976), "a resident colony has a certain attraction for passing swarms which are quite capable of trying to take it over". However, no previous research has been done with combinations of these three factors under conditions normally encountered by beekeepers.

The purpose of the present study was to determine the effect of proximity of apiaries, height above ground, and presence of synthetic Nasonov pheromone in attracting AHB swarms to bait hive stations.

ACKNOWLEDGMENTS

This study was supported in part by Grant 25–21–RC293–136/ USDA/ ABIP-DIETZ to Dr. Alfred Dietz. The University of Georgia provided vehicles and logistical support during the field work.

Adalberto Pérez de León, Pablo, Benjamín and Floriberto Mora, Marcelino Pérez, Juan García and Tilo Raúl helped with field work. I am also grateful to Dr. George W. Byers and two anonymous reviewers for helpful suggestions to improve the manuscript.

MATERIALS AND METHODS

The bait hives used in the present experiment were standard Langstroth hive bodies which had been previously occupied by honeybees.

Bait hive stations were established either within bee yards ("Dependent" locations [D]) or 1.7–5 km from the nearest bee yard ("Independent" locations [I]). Each bait

¹ Departamento de Química y Biología, Universidad de las Américas-Puebla, 72820 Santa Catarina Mártir, Puebla, MÉXICO.
E-mail: cvergara@mail.pue.udlap.mx

Table 1. Number of swarms captured in each line and each bait hive category, and the corresponding calculated swarm-capture indexes.

A Line	B Months	C Bait hives in each category	D B × C	E	BAIT HIVE CATEGORIES								TOTAL
					F D,H,P	G D,H,P-	H D,L,P	I D,L,P-	J I,H,P	K I,H,P-	L I,L,P	M I,L,P-	
1A	8	12	96	Swarms Index ¹	17 177	5 52	1 10	1 10	32 333	15 156	1 10	1 10	73 760
1B	24	15	360	Swarms Index	24 67	12 33	3 8	3 8	63 175	31 86	3 8	6 17	145 403
2	33	9	297	Swarms Index	2 7	1 3	0 0	0 0	5 17	5 17	1 3	2 7	16 54
3	9	9	81	Swarms Index	1 12	0 0	0 0	1 12	5 62	2 25	1 12	1 12	11 136
TOTAL				Swarms Index	44 263	18 89	4 19	5 31	105 587	53 284	6 34	10 46	245 1353

¹ Index = [Number of swarms per category / Column D] × 1,000

hive station established during the study period consisted of 12 bait hives, arranged in the following manner:

Six bait hives were hung from tree branches at a height of at 3–4 m above ground (High bait hives [H]). The other 6 were secured to the base of the same tree at a height of 0.4–0.5 m above ground (Low bait hives [L]). The presence or absence of pheromone lure in the bait hives was randomly determined among six pairs of H/L bait hives. That is, three of the H/L bait hive pairs received pheromone lures ("Pheromone" [P]) and the other three bait hive pairs were not provisioned with pheromone ("No Pheromone" [P-]). Thus, 8 different bait hive categories were used in the study:

- | | |
|-----------|-----------|
| 1. D,H,P | 5. I,H,P |
| 2. D,H,P- | 6. I,H,P- |
| 3. D,L,P | 7. I,L,P |
| 4. D,L,P- | 8. I,L,P- |

The pheromone lure used was synthetic Nasonov pheromone blend consisting of 1:1:1 mixture of E:Z citral (Sigma Chemical), geraniol (Sigma Chemical), nerolic and geranic acids, dissolved in mineral oil at a concentration of 1% (vol/vol). The mixture of nerolic and geranic acids was synthesized by Dr. Karl Espelie (Department of Entomology, University of Georgia) according to Pickett et al. (1980). This pheromone blend was held in 0.5 ml polyethylene centrifuge microtubes, secured inside the bait hive.

Three monitoring lines of managed EHB were used during the study. The first monitoring line was established in Tabasco, between November 1987 and October 1990. During the period of November 1987 to October 1988, a total of 240 colonies, in 6 apiaries, was used. Four D and four I bait hive stations were maintained in line 1 for the

period March–October, 1988. This data set will be referred to as line 1A. Between November 1988 and October 1990 five D and five I bait hive stations were used and the number of colonies was reduced to 140, in 7 apiaries. The data set collected during this period will be called line 1B.

A second monitoring line was maintained between Nautla and Martínez de la Torre in the central part of Veracruz, from February 1988 to October 1990. Six apiaries, each with 20 colonies, were established along this line. Three D and three I bait hive stations were placed along monitoring line 2.

Between March and October 1990, a third monitoring line was established in the northern part of Veracruz, between Tamiagua and Tuxpan. Six apiaries of 20 colonies each were maintained on line 3, as well as three D and three I bait hive stations.

All bait hives were inspected periodically during the duration of the study for honey bee swarms. Any bait hives containing non-honey bee occupants were removed, reconditioned and replaced on the tree.

Since the number of bait hive stations, as well as the duration of the experiment, changed across data sets, it was necessary to calculate a unified swarm capture index. A total swarm capture index was calculated for each line by dividing the total number of swarms captured in each line and each bait hive category during the study period over the product of multiplying the number of bait hives in each category by the number of months the bait hives were in place. The number obtained was multiplied by 1,000.

Pair-wise comparisons were performed using the X² test (Siegel & Castellan, 1988) for:

Table 2. Total numbers of swarms captured and capture indexes for D, I, H, L, P, and P- and pair-wise comparisons H vs. L, P vs. P-, and D vs. I.

Line		Total Dependent (F+G+H+I) ¹	Total Independent (J+K+L+M)	Total High (F+G+J+K)	Total Low (H+I+L+M)	Total Pheromone (F+H+J+L)	Total No Pheromone (G+I+K+M)
1A	Swarms	24	49	69	4	51	22
	Index ¹	250	510	719	42	531	229
1B	Swarms	42	103	130	15	93	52
	Index	117	286	361	42	258	144
2	Swarms	3	13	13	3	8	8
	Index	10	44	44	10	27	27
3	Swarms	2	9	8	3	7	4
	Index	25	111	99	37	86	49
TOTAL	Swarms	71	174	220	25	159	86
	Index	401	951	1222	130	902	450
χ^2		15.37**		67.91**		11.94**	

¹ Same as in Table 1

**Significant at the 0.001 level

1. Dependent vs. Independent bait hives, i.e. the sum of all categories where dependent bait hives were used versus the sum of all categories where independent bait hives were used.
2. High vs. Low bait hives. Same as in 1., but for High and Low bait hives.
3. Pheromone vs. No Pheromone. Same as in 1., but for Pheromone and No Pheromone bait hives.

The numbers of swarms captured every month in every bait hive category and each monitoring line were transformed to ranks and subsequent analysis of variance of a 2³ factorial design (Steel & Torrie, 1980) were performed for each of the four data sets, in order to compare with each other the two levels of each of the three factors examined and to determine any significant first and second order interactions between factors. The application of rank transformation to the data and the use of parametric analysis on the ranked values is equivalent to performing a non-parametric test on the unranked values (Conover, 1980).

RESULTS

The number of swarms captured in each line and the corresponding calculated swarm capture indexes are shown in Table 1. The highest capture index was found in all monitoring lines for IHP bait hives, except for line 2, where equal capture indexes were found for IHP and IHP- bait hives. The highest capture index for line 1A was recorded in March, although high numbers were also obtained in April, May and July. The largest number of swarms captures was recorded for line 1B during February–May 1989 and February–May 1990. A secondary swarm activity peak was recorded during November 1988.

The period of greatest swarms activity for line 2 was between July and November 1989. Before July 1989, only two swarms had been captured along this line. In line 3 the highest number of swarms was captured during May–June. A secondary period of swarming was observed during August and September.

Table 2 shows the total number and capture indexes for D, I, H, L, P, and P- and the pair-wise comparisons H vs. L, P vs. P-, and D vs. I. A statistically significant difference was found at the 0.001 level between the members of all the pairs compared.

Table 3 presents the F values obtained for the analysis of variance performed for all monitoring lines. For bait hive location, there is a significant effect at the 0.05 level in lines 1A and 2, and at the 0.01 level in line 1B. For bait hive height there is also a significant effect at the 0.05 level in line 2, and at the 0.01 level in lines 1A and 1B. Also, there is a significant interaction, at the 0.05 level between bait hive location and bait hive height in line 1A and at the 0.01 level in line 1B.

DISCUSSION

The most important factor in attracting and capture honeybee swarms in bait hives was the height at which the bait hives were located. The total number of swarms captured by H bait hives was significantly different from the total number captured by L bait hives, and was higher than the number of swarms captured in any other category. When the effect of bait hive height was analyzed separately for each line, high bait hives also captured significantly higher numbers of swarms, except for line 3. The importance of putting bait hives high up into trees has been rec-

Table 3. Analysis of Variance and F values obtained for all monitoring lines.

Factor		Line 1A	Line 1B	Line 2	Line 3
Bait hive Location (A)	F	5.266*	10.268**	5.757*	1.233
Dependent vs. Independent	d.f.	1 35	1 131	1 185	1 41
Bait hive height (B)	F	34.928**	50.702**	5.757*	0.155
High vs. Low	d.f.	1 35	1 131	1 185	1 41
Pheromone (C)	F	1.478	1.468	0.062	0.104
Present vs. Absent	d.f.	1 35	1 131	1 185	1 41
Interaction AB	F	5.266*	6.654**	0.656	0.155
	d.f.	1 35	1 131	1 185	1 41
Interaction AC	F	0.025	0.002	0.078	0.104
	d.f.	1 35	1 131	1 185	1 41
Interaction BC	F	1.478	3.372	0.608	0.155
	d.f.	1 35	1 131	1 185	1 41
Interaction ABC	F	0.025	0.334	0.062	1.081
	d.f.	1 35	1 131	1 185	1 41

* Significant at the 0.05 level

**Significant at the 0.01 level

ognized since antiquity, and scientific confirmation has been obtained for EHB (Seeley, 1982; Seeley and Morse, 1978). The results presented here suggest that AHB swarms also prefer to occupy bait hives placed at heights of at least 3 m above ground. To my knowledge, there is no information on similar tests performed with African honey bees, but other authors, as a rule, always located the bait hives they used at least 2 m above ground level (Schmidt & Thoenes, 1992; Winston et al., 1993; Schmidt, 1994; Schmidt & Hurley, 1995.)

The situation is similar for bait hive location. The total number of swarms captured by D bait hives was significantly different from the total number captured by I bait hives and the effect of bait hive location with respect to apiaries was statistically significant for lines 1A, 1B and 2 (Table 3). Again, the effect of this factor was not significant for line 3.

The results obtained for bait hive height and bait hive location could indicate that the effect of these factors is noticeable only when the density of invading swarms reaches a hypothetical threshold value, which possibly had not been met in line 3, since this line was located at the northernmost locality examined in this study, and the front of invading African swarms was coming from the south. This suggestion is based on the situation observed in line 1A, where the feral AHB population was in the build-up phase that occurs during the first two years following the first findings of AHB in a given area (Boreham & Roubik, 1987). The first report of AHB captured in Tabasco occurred in July 1987 (Vergara et al., 1993). Also, line 3 was in place only during 9 months, and no swarms were captured dur-

ing the first three months. This means that the data presented here represent only 6 months of sampling. Any statistical analysis of this data set would be less sensitive than analyses performed for the other three lines, where the numbers of swarms captured was high or very high from the beginning.

The use of synthetic Nasonov pheromone blends has been reported by several authors to make bait hives more attractive to swarms. The difference in swarm capture between baited and unbaited bait hives has been dramatic in many cases (reviewed by Witherell, 1985; Schmidt, 1994). In the present study the difference in swarm capture between P and P- bait hives was significantly different for the total (Table 2), but when the effect of presence of pheromone was analyzed, it was not significant for any of the lines (Table 3). This result could be an artifact of the experimental design, since lured and unlured bait hives were separated in some cases only by 2 or 3 m. This short distance could cause the effect of making the whole station function as if all the bait hives had pheromone lures. An experiment using separate unlured and lured bait hive stations, as well as combinations of lured and unlured bait hives in the same station, could clarify this effect. However, Schmidt and Thoenes (1992), Winston et al. (1993) and Schmidt (1994) have used similar designs to the one used for this study, and found significant differences in swarm capture rates between the different treatments (i.e. lured vs. unlured, different mixtures of Nasonov pheromone components, presence or absence of nerolic acid in the mixture, etc.). Also, the fact that the hives used as bait hives in the present study had been previously occupied by bees could obscure the effect of the pheromone lures. Moreover, the analysis of the effect of synthetic Nasonov pheromone bait is confounded by the existing interaction between bait hive height and presence/absence of pheromone lures.

The low number of honeybee swarms attracted to bait hives in line 2 could be partially explained by the particular topographic conditions of this line. The D and I bait hive stations in line 2 were located along a road running in a southwest-northeast direction and roughly parallel to the Bobos River. The south bank of the river is the northernmost end of a mountain range running for 50–60 km very close to the coast of the Gulf of Mexico. The distance from the coast line is approximately 5–15 km to the 100 m contour and 20–30 km to the 500 m contour. The mountains reach an altitude of over 2,000 m above sea level in a relatively short distance (55 km) from the coast near Tenochtitlán (Veracruz). This particular topographic condition could conceivably have a highly directional effect on swarm movement to the northeast. This directional movement would lead swarms in the colonizing front

away from the bait hive stations, and toward the mangroves found by the coast in this area. These mangroves may also provide more attractive food sources than the grazing lands and citrus fruit plantations extensively found along line 2.

LITERATURE CITED

- Boreham, M. M. & D. W. Roubik. 1987. Population change and control of Africanized honey bees (Hymenoptera: Apidae) in the Panama Canal area. *Bulletin of the Entomological Society of America* 33: 34–39.
- Conover, W. J. 1980. *Practical Nonparametric Statistics*. 2nd ed. John Wiley and Sons. New York. 493 pp.
- Dietz, A. & C. Vergara. 1995. Africanized honey bees in temperate zones. *Bee World* 76: 56–71
- Loper, G. M. 1997. Genetic evidence of Africanization of feral colonies in South Arizona between 1993 and 1995. *American Bee Journal* 137: 669–671
- Pickett, J. A., I. H. Williams, A. P. Martin & M. C. Smith. 1980. Nasonov pheromone of the honeybee, *Apis mellifera* (Hymenoptera: Apidae) Part I. Chemical characterization. *Journal of Chemical Ecology* 6: 425–434.
- Rinderer, T. E., A. M. Collins, A. B. Bolten & J. R. Harbo. 1981. Size of nest cavities selected by swarms of Africanized honeybees in Venezuela. *Journal of Apicultural Research* 20: 160–164.
- Rinderer, T. E., K. W. Tucker and A. M. Collins. 1982. Nest cavity selection by swarms of European and Africanized honeybees. *Journal of Apicultural Research* 21:98–103
- Rubink, W. L., P. Luévano-Martínez, E. A. Sugden, W. T. Wilson & A. M. Collins. 1996. Subtropical *Apis mellifera* (Hymenoptera: Apidae) swarming dynamics Africanization rates in northeastern Mexico and southern Texas. *Annals of the Entomological Society of America* 89:243–251
- Schmidt, J. O. 1994. Attraction of reproductive honey bee swarms to artificial nests by Nasonov pheromone. *Journal of Chemical Ecology* 20: 1053–1056
- Schmidt, J. O. & A. C. Thoenes. 1992. Criteria for nest site selection in honey bees (Hymenoptera: Apidae): preferences between pheromone attractants and cavity shapes. *Environmental Entomology* 21: 1130–1133
- Schmidt, J. O. & R. Hurley. 1995. Selection of nest cavities by Africanized and European Honey Bees. *Apidologie* 26:467–475
- Seeley, T. D. 1982. How honey bees find a home. *Scientific American*. 247:158–168
- Seeley T. D. & R. A. Morse. 1977. Dispersal behavior of honey bee swarms. *Psyche* 86: 103–113
- Seeley T. D. & R. A. Morse. 1978. Nest site selection by the honey bee, *Apis mellifera*. *Insectes Sociaux* 25: 323–337.
- Siegel, S. & N. J. Castellan 1988. *Nonparametric Statistics for the Behavioral Sciences*. Second edition. McGraw-Hill Book Company. Singapore. 399 pp.
- Silberrad, R. E. M. 1976. *Bee-keeping in Zambia*. Apimondia, Bucharest. 74 pp.
- Steel, R. G. D. & J. H. Torrie. 1980. *Principles and Procedures of Statistics. A biometrical Approach*. McGraw-Hill Inc. New York, xxi + 622 pp.
- Taylor, O. R. & G. W. Otis. 1978. Swarm boxes and Africanized bees: some preliminary observations. *Journal of the Kansas Entomological Society* 51: 807–817
- Vergara, C., A. Dietz & A. Pérez de León. 1993. Female parasitism of European honey bees by Africanized honey bee swarms in Mexico. *Journal of Apicultural Research* 32:34–40
- Winston, M. L., K. N. Slessor, W. L. Rubink & J. D. Villa. 1993. Enhanced pheromone lures to attract honey bee swarms. *American Bee Journal* 133: 58–60
- Witherell, P. C. 1985. A review of the scientific literature relating to honey bee bait hives and swarm attractants. *Am. Bee. J.* 125: 823–829.

Population Genetics of the Greater Wax Moth, *Galleria mellonella* L. (Lepidoptera: Pyralidae)

By

AMY M. McMILLAN¹

ABSTRACT Greater wax moths, *Galleria mellonella* L., are beehive parasites with populations that are patchy and discrete. This type of population structure often produces genetic differentiation between patches of populations. However, the transport of commercial beehives throughout the United States may serve to increase migration among wax moth populations and cause genetic homogeneity across patches of populations. This study used the allozymic genetic structure of the greater wax moth to make inferences about the gene flow between populations of this habitat-specialized and destructive insect pest.

Twenty-two electrophoretic enzyme loci were resolved out of the forty enzymes tested. Greater wax moths had low detectable allozymic diversity with only six polymorphic loci. Three reliably scored polymorphic loci were surveyed for six population samples of the greater wax moth: four samples from Kansas, one from Alabama, and one from Louisiana. These three loci had an average observed heterozygosity of 0.320. The within-population inbreeding coefficient, F_{IS} , was not different from zero, which suggests random mating within sampling units. Wright's F_{ST} estimates indicated significant genetic differentiation among all samples (average $F_{ST} = 0.118 \pm 0.004$). A separate analysis of the Kansas samples also showed genetic differentiation on a local scale (average $F_{ST} = 0.164 \pm 0.013$). Indirect estimates of Nm , the number of migrants per generation, averaged 1.86 (all samples) and 1.28 (Kansas samples). The results of this study indicate greater wax moths have differentiated populations with fairly low gene flow (migration) at both local and regional scales.

Keywords: Dispersal; Differentiation; Allozymes; Wright's F-statistics, Honey bee.

INTRODUCTION

Populations of the greater wax moth are widely distributed in most warm temperate and tropical regions of the world wherever honey bees (*Apis mellifera*) are found (Eishen et al., 1986). Larvae of *Galleria mellonella* L. consume honeybee comb and comb contents (Nielsen and Brister, 1979). Bee colonies with declining numbers of workers are most vulnerable (Roling, 1985; Eishen et al., 1986). Wax moths also can be particularly damaging to honey bee comb that is in storage (Delange, 1987). Adult moths do not feed and live two to three weeks (Nielsen and Lambremont, 1976). Adults can fly but probably remain close their birthplace to mate and oviposit (Nielsen and Brister, 1977; Flint and Merkle, 1983). Based on this limited demographic information, dispersal may be rare, which would tend to promote genetic differentiation among populations (Wright, 1951). However, honey bee colonies are moved around the United States for commercial pollination services (Marison, 1993), and some wax moth movement may occur this way, resulting in more frequent migration and colonization events than might be expected without hive transportation. If transportation of

beehives is resulting in the movement and mixing of greater wax moths, then the genetic differentiation between wax moth populations would be below that expected from sedentary populations.

Genetic differentiation among sampled populations is often measured using Wright's F_{ST} , which is a population fixation index (Wright, 1951). Several studies comparing genetic differentiation among various insect groups have found that where habitat use is highly specialized populations tend to differentiate (Pashley et al., 1985; McCauley and Eanes, 1987; Sweeney et al., 1987). Recently, Peterson and Denno (1997) determined with allozyme surveys that population-genetic subdivision is increased when dispersal ability is limited. On the other hand, migratory species, such as monarch butterflies, tend to have low genetic differentiation among population samples (Eanes and Koehn, 1978).

This study was conducted to quantify the genetic structure of six discrete population samples of *Galleria mellonella* for polymorphic loci and population subdivision, as measured with Wright's F_{ST} . F_{ST} estimates calculated from the genetic data gathered for this study were used to

¹ Department of Entomology, University of Kansas, Lawrence, KS 66045. Present address: 59 Shaws Mill Road, Gorham, ME 04038.
E-mail: mcmillan@maine.edu

estimate indirectly the number of migrants exchanged between populations on a local and regional scale (Wright, 1951).

ACKNOWLEDGMENTS

Byron Alexander was a great man and he will be sorely missed. Byron was a steady person who could always be relied upon to give honest, insightful advice, and that ability is what I miss most about him. He loved hymenopterans and I think it would have appealed to his sense of humor to have a paper on honeybee pests in his memorial volume.

Thanks to R. Gomulkiewicz for financial and advisory support, R. Hagen and D. Smith for electrophoretic expertise and facilities, and R. Bean, R. Collins, M. Greenfield, R. Minkley (and family), C. Pennuto, O. Taylor, H. Spangler, and the Experimental and Applied Ecology program for wax moth collections and collection sites. Two anonymous reviewers provided insightful comments to improve the manuscript. This study was funded by a General Research Fund grant from the University of Kansas to R. Gomulkiewicz.

METHODS

Six wax moth populations were sampled in 1993 and 1994 to assess the genetic structure found in natural populations of these moths. Four sample sites were located in Kansas (BAL94, BEAN, HAW, and NESAs) and one each in Alabama (AL) and Louisiana (LA). The AL and LA larvae were handpicked from infested hives and shipped to Lawrence in 1994. BAL94 and NESAs were collected with baited boxes (cardboard boxes containing freeze-sterilized comb placed in the field an unknown distance from infested hives and collected when infested), whereas HAW and BEAN were collected from infested comb from extant hives. The BAL94 site was located in a field approximately 25 km south of Lawrence in 1994 and BEAN was collected within 1.7 km of the BAL94 site in 1993. NESAs were collected from a field approximately 25 km north of Lawrence in 1994. The HAW hive was located in Lawrence and collected in 1994. Larvae from all populations were placed on freeze-sterilized comb in the laboratory. Adults were collected following emergence and frozen at -80°C until they were used for electrophoresis.

An additional large sample of larvae was collected from a comb storage area on the University of Kansas west campus (KU sample). These individuals were used for the initial screening of the enzyme systems and for allozymic diversity estimates but were not used in the F -statistics analysis. The KU sample differed from the other collection sites in that infested hive from a number of apiaries were probably represented whereas the other samples came from a single, discrete source area.

Table 1. Allele frequencies and heterozygosity estimates for six population samples of *Galleria mellonella* at three allozyme loci. All samples fit Hardy-Weinberg expectations. NESAs, BAL94, BEAN, and HAW samples are from western Kansas (see text).

Locus	Sample	N	'Fast' Allele Frequency	Heterozygosity	
				Observed	Expected
<i>Pgm</i>	NESA	31	1.000	0.000	0.000
	BAL94	32	1.000	0.000	0.000
	BEAN	31	0.742	0.323	0.383
	HAW	31	0.694	0.419	0.425
	AL	30	0.850	0.233	0.255
	LA	22	0.773	0.455	0.351
<i>Gpi</i>	NESA	35	1.000	0.000	0.000
	BAL94	32	0.766	0.469	0.359
	BEAN	34	0.691	0.441	0.427
	HAW	34	0.897	0.206	0.185
	AL	31	0.581	0.452	0.487
	LA	22	0.795	0.409	0.325
<i>Mpi</i>	NESA	28	0.357	0.571	0.459
	BAL94	32	0.734	0.406	0.390
	BEAN	33	0.742	0.273	0.382
	HAW	31	0.371	0.355	0.467
	AL	30	0.550	0.433	0.495
	LA	22	0.659	0.500	0.449

Enzyme electrophoresis was conducted on thin-layer cellulose acetate plates, using stain recipes and methods of Richardson et al. (1986) and Hagen and Scriber (1991). Twenty-two loci were resolved, out of the 40 enzyme systems tested. Six of the 22 resolved loci were polymorphic but only three polymorphic loci were reliably scored. The three reliably scored, polymorphic loci were used for all F -statistics analyses.

Allele and genotype frequencies were calculated separately for each sample and locus. Genotype frequencies for each polymorphic locus in each sample were tested for agreement with Hardy-Weinberg proportions, using a chi-square goodness-of-fit test. The genetic divergence between populations and total and within-population inbreeding coefficients were estimated by Wright's F -statistics, using QBASIC programs by M. Whitlock and J. Long (formulas in Long, 1986, and Weir, 1996). Significant difference from zero of all F -statistics was calculated with a conversion of Wilk's lambda to an F value using the QBASIC program by J. Long (Long, 1986; Chakraborty and Danker-Hopfe, 1991). Indirect estimates of the number of migrants per generation (Nm) for each locus and all loci combined were calculated by $F_{ST} = 1/(4Nm+1)$ (Wright, 1951).

RESULTS

ALLOZYME SURVEY

The three loci used for the F -statistic analysis were phosphoglucosmutase (*Pgm*, EC 2.7.5.1), glucose phosphate

Table 2. F -statistics, gene flow estimates, and significance test results for three polymorphic loci from (a) six population samples of *Galleria mellonella* and (b) four western Kansas population samples of *G. mellonella*.

Locus	F_{IS}	F_{ST}	F_{IT}	Nm
a) <i>Pgm</i>	0.028	0.122***	0.146	1.80
<i>Gpi</i>	-0.084	0.126***	0.052	1.74
<i>Mpi</i>	0.071	0.107***	0.171*	2.08
Combined ¹	0.005	0.118	0.123	1.86
(s.e.)	0.029	0.004	0.023	
b) <i>Pgm</i>	0.098	0.198***	0.276**	1.01
<i>Gpi</i>	-0.132	0.127***	0.012	1.72
<i>Mpi</i>	0.082	0.166***	0.234*	1.25
Combined ¹	0.016	0.164	0.174	1.28
(s.e.)	0.047	0.013	0.052	

¹ Jackknifed combined estimators and estimator standard errors (Weir 1996).

* $p < .05$; ** $p < .01$; *** $p < .001$

isomerase (*Gpi*, EC 5.3.1.9), and mannose-6-phosphate isomerase (*Mpi*, EC 5.3.1.8). These enzyme systems were best resolved using Buffer I of Richardson et al. (1986). Each of these enzymes had one locus with two alleles designated as fast or slow by relative mobility. These loci were not sex-linked; both males and females appeared as heterozygotes. The average observed heterozygosity at these loci was 0.320 (Table 1). Three additional loci appeared polymorphic but were not reliably scored (peptidase, using phenylalanine-proline as substrate, and two esterases). Fourteen further enzyme systems were resolved for at least 12 individuals from the KU sample, yielding 16 putative monomorphic loci, using various buffer systems from Richardson et al. (1986). These were *Aat*, *Ac*, *Ada*, *Ak*, *Ald*, *Aldh*, *Fum*, *G3pdh*, *Hk*, *Idh*, *Mdh*, *Me*, *P3gdh*, and one locus of phe-pro peptidase. Abbreviations follow Richardson et al. (1986), who include the full name, EC number, and activity information on each. Some of these loci were also resolved for individuals from the study populations and were consistently monomorphic for the same allele found in the KU sample.

GENETIC STRUCTURE

All population samples were in agreement with Hardy-Weinberg proportions at each of the polymorphic loci (Table 1). F -statistics were calculated for six sample locations of wax moths for the three polymorphic loci (*Pgm*, *Gpi*, and *Mpi*). Each locus showed significant population subdivision ($F_{ST} > 0$; Table 2). F -statistics were also calculated separately for the four Kansas populations. These calculations showed genetic differentiation between sample populations on even a local scale (Table 2). The F_{ST} estimates calculated for the sampled wax moths in this study are some of the highest reported in Lepidoptera (e.g.,

Table 3). Indirect estimates of Nm (number of migrants per generation) ranged from 1 to 2 individuals per generation (Table 2).

DISCUSSION

Although overall genetic polymorphism appears low in wax moths, as evidenced by the small number of polymorphic loci among all the allozyme loci screened in this study, expected heterozygosity values for the three reliably scored polymorphic loci are generally higher than those reported elsewhere for Lepidoptera (Graur, 1985). Of these enzymes, *Pgm* and *Gpi* had a fixed allele in at least one population suggesting some genetic drift within populations (Table 1). *Mpi* was polymorphic in all populations. Studies such as this assume selectively neutral allozyme loci. However, the lack of any monomorphic populations at the *Mpi* locus might suggest that this locus is closely linked to a selectively critical gene, maintaining its polymorphism (Vrijenhoek, 1994) or is selectively important itself (i.e., Watt, 1977; 1994). A larger number of sample populations or additional polymorphic allozyme loci would help to clarify this pattern.

Hardy-Weinberg chi-square goodness-of-fit tests and the F_{IS} estimates test for random mating within populations. If either measure is significant, deviations from random mating are suspected. The results of the significance tests for F_{IS} and the agreement with Hardy-Weinberg proportions suggest random mating within populations. F_{ST} measures random genetic drift between population samples and significant F_{ST} estimates indicate genetic differentiation of population samples. The estimates from this study were highly significant ($p < .001$, Table 2). The combined F_{ST} values found for all populations in this study (ranging from 0.107 to 0.126) suggest greater wax moths exhibit an intermediate to high level of genetic differentiation regionally (Table 2 (a); Wright, 1978; Long, 1986). The high degree of differentiation found among the Kansas population samples (F_{ST} values from 0.127 to 0.198; Table 2 (b)) was unexpected. The eastern edge of Kansas is part of the annual transportation route for commercial honey bee hives and presumably wax moths (Marison, 1993). Furthermore, these sampling sites were relatively close to each other (distance between sites varied from ~1.5 km to ~50 km). Both of these conditions are expected to genetically homogenize populations at a local scale. However, the F_{ST} estimates from this study suggest dispersal of wax moths is limited.

Personal observations of colonization events during this study suggest new populations of greater wax moths are probably colonized by a small number of dispersing, mated, female founders. This type of population formation samples only a small number of genes from the origi-

Table 3. Comparative genetic differentiation estimates (F_{ST}) for several Lepidoptera species.

Species		Number of Populations	Loci	F_{ST}	Sampling Range	Reference
<i>Alabama argillacea</i>	Cotton leafworm	2	13	0.007	Mexico, Brazil	Pashley, 1985
<i>Danaus plexippus</i>	Monarch butterfly	29	6	0.009	East, Midwest U.S.	Eanes and Koehn, 1978
		18	6	0.032	Australia	Hughes and Zalucki, 1984
<i>Anticarsia gemmatalis</i>	Velvetbean caterpillar	6	19	0.021	East U.S., Mexico, Central America	Pashley and Johnson, 1986
<i>Erebia embla</i>		4	5	0.024	Central Sweden	Douwes and Stille, 1988
<i>Dendrolimus pini</i>	Pine moth	3	10	0.029	Belorussia, Ukraine	Emel'yanov and Goncharenko, 1992
<i>Diatraea grandiosella</i>	Southwestern cornborer	7	4	0.037	Midwest U.S.	McCauley et al., 1990
		8	4	0.272	Mexico, Midwest U.S.	McCauley et al., 1990
<i>Zeiraphera dimiana</i>	Larch budmoth	7	13	0.083	Britain, West Europe	Emelianov et al., 1995
<i>Spodoptera frugiperda</i>	Fall armyworm	9	12	0.084	East U.S., Mexico, Puerto Rico	Pashley et al., 1985
<i>Euphydryas chalcedona</i>	Chalcedona checkerspot	10	8	0.090	California	cited in Pashley et al., 1985
<i>Dioryctria disclusa</i>	Webbing coneworm	14	8	0.111	East U.S.	Richmond, 1995
<i>Euphydryas editha</i>	Checkerspot	21	8	0.118	California	cited in Pashley et al., 1985
<i>Galleria mellonella</i>	Greater wax moth	6	3	0.133	Midwest, Southeast U.S.	present study
<i>Parnassius mnemosyne</i>	Mountain butterfly	24	9	0.135	South France	Napolitano and Descimon, 1994

nating population, which can have a large affect on the population genetic structure across populations (Wade and McCauley, 1988) and may be the underlying reason for the high F_{ST} s found in this study. It is also consistent with the low allozymic diversity (i.e., many monomorphic loci) found in wax moths. Another explanation for the relatively high genetic differentiation in this study may be that dispersal ability of wax moths is limited (i.e., Peterson and Denno, 1997). Several bait boxes that were set out for infestation were never colonized by wax moths. However, some of my artificial hives were successfully colonized, which supports the hypothesis that colonization mode may be more important than dispersal ability in structuring greater wax moth populations. This study also suggests commercial movement of bee hives is not homogenizing wax moth populations in the areas sampled. A separate study of summer populations in the north and winter populations in the south of the United States may reveal a different pattern.

The F_{ST} values calculated for *G. mellonella* in this study indicate genetic differentiation of wax moth populations. These F_{ST} estimates are some of the highest reported for Lepidoptera and are similar to those of insects that rely on patchy resources and/or have a limited dispersal capacity in the spatial scale studied (Pashley et al., 1985; McCauley and Eanes, 1987; Sweeney et al., 1987). Greater wax moth samples from this study have genetic differentiation estimates similar to butterflies with restricted population patches (e.g., the mountain butterfly, Napolitano and Descimon, 1994) or populations known to be sedentary (e.g. checkerspot butterfly, Pashley et al., 1985) (Table 3). The F_{ST} values calculated in this study are much higher

than those reported for species with very large resource patches or excellent dispersal abilities (e.g., monarch butterflies, Eanes and Koehn, 1978; Table 3).

It is clear from this study that populations of the greater wax moth are genetically differentiated at a local and regional scale, as evidenced by high F_{ST} estimates, despite human vectored movement of commercial beehives. Knowledge of population substructure at these scales may assist apiarists in planning control measures for this damaging pest. Further allozyme screening and a larger number of wax moth populations will be needed for a more thorough population analysis to verify these preliminary results. More demographic information about *G. mellonella*, including direct observation of dispersal and population founding, would help to confirm the data on genetic structure gathered for this study.

LITERATURE CITED

- Chakraborty, R. and H. Danker-Hopfe. 1991. Analysis of population structure: a comparative study of different estimators of Wright's fixation indices. Pp. 203-254, in C. R. Rao and R. Chakraborty (eds.), *Handbook of Statistics*. Vol. 8. Amsterdam, The Netherlands: Elsevier Science Publishers, B. V.
- Delange, H. J. 1987. Wax moth: Timely notes on why and how. *Gleanings in Bee Culture*, November: 658, 661.
- Douwes, P. and B. Stille. 1988. Selective versus stochastic processes in the genetic differentiation of populations of the butterfly *Erebia embla* (Thnbg) (Lepidoptera, Satyridae). *Hereditas* 109: 37-43.
- Eanes, W. F. and R. K. Koehn. 1978. An analysis of genetic structure in the monarch butterfly, *Danaus plexippus* L. *Evolution* 32: 784-797.
- Eischen, F. A., T. E. Rinderer, and A. Dietz. 1986. Nocturnal defensive responses of Africanized and European honeybees to the greater wax moth (*Galleria mellonella* L.). *Animal Behaviour* 34: 1070-1077.
- Emel'yanov, I. M. and G. G. Goncharenko. 1992. Genetic variation, popu-

- lation structure and gene flow in the pine moth *Dendrolimus pini* L. (Lepidoptera) in Belorussian and Ukrainian forests. *Soviet Genetics* 28: 438–448. Translated from *Genetika* 28: 72–84.
- Emelianov, I., J. Mallet, and W. Baltensweiler. 1995. Genetic differentiation in *Zeiraphera diniana* (Lepidoptera: Tortricidae, the larch budmoth): polymorphism, host races or sibling species? *Heredity* 75: 416–424.
- Flint, H. M., and J. R. Merkle. 1983. Mating behavior, sex pheromone responses, and radiation sterilization of the greater wax moth (Lepidoptera: Pyralidae). *Journal of Economic Entomology* 76: 467–472.
- Graur, D. 1985. Gene diversity in Hymenoptera. *Evolution* 39: 190–199.
- Hagen, R. H. and J. M. Scriber. 1991. Systematics of the *Papilio glaucus* and *P. troilus* species groups (Lepidoptera: Papilionidae): inferences from allozymes. *Annals of the Entomological Society of America* 84: 380–395.
- Hughes, J. M. and M. P. Zalucki. 1984. Genetic variation in a continuously breeding population of *Danaus plexippus* L. (Lepidoptera: Nymphalidae). *Heredity* 52: 1–7.
- Long, J. C. 1986. The allelic correlation structure of Gainj- and Kalam-speaking people. I. The estimation and interpretation of Wright's *F*-statistics. *Genetics* 112: 629–647.
- Marison, A. 1993. America's beekeepers: hives for hire. *National Geographic* 183: 73–93.
- McCauley, D. E. and W. F. Eanes. 1987. Hierarchical population structure analysis of the milkweed beetle, *Tetraopes tetraophthalmus* (Forster). *Heredity* 58: 193–201.
- McCauley, D. E., F. J. Breden, G. M. Chippendale, and J. A. Mihm. 1990. Genetic differentiation of populations of the southwestern corn borer (Lepidoptera: Pyralidae) from the United States and Mexico. *Annals of the Entomological Society of America* 83: 586–590.
- Napolitano, M. and H. Descimon. 1994. Genetic structure of French populations of the mountain butterfly *Parnassius mnemosyne* L. (Lepidoptera: Papilionidae). *Biological Journal of the Linnean Society* 53: 325–341.
- Nielsen, R. A. and C. D. Brister. 1977. Greater wax moth: adult behavior. *Annals of the Entomological Society of America* 70: 101–103.
- Nielsen, R. A. and C. D. Brister. 1979. Greater wax moth: behavior of larvae. *Annals of the Entomological Society of America* 72: 811–815.
- Nielsen, R. A. and E. N. Lambremont. 1976. Radiation biology of the greater wax moth: inherited sterility and potential for pest control. Technical Bulletin No. 1539. Washington, D.C.: United States Department of Agriculture. 31 pp.
- Pashley, D. P. 1985. The use of population genetics in migration studies: a comparison of three noctuid species. Pp. 305–324, in C. Barfield, R. D. Berger, G. G. Kennedy, and D. R. MacKenzie (eds.), *Movement and Dispersal of Biotic Agents*. Baton Rouge, Louisiana: Louisiana State University.
- Pashley, D. P. and S. J. Johnson. 1986. Genetic population structure of migratory moths: the velvetbean caterpillar (Lepidoptera: Noctuidae). *Annals of the Entomological Society of America* 79: 26–30.
- Pashley, D. P., S. J. Johnson, and A. N. Sparks. 1985. Genetic population structure of migratory moths: the fall armyworm (Lepidoptera: Noctuidae). *Annals of the Entomological Society of America* 78: 756–762.
- Peterson, M. A. and R. F. Denno. 1997. The influence of intraspecific variation in dispersal strategies on the genetic structure of planthopper populations. *Evolution* 51: 1189–1206.
- Richardson, B. J., P. R. Baverstock, and M. Adams. 1986. *Allozyme Electrophoresis*. New York, New York: Academic Press. xii+410 pp.
- Richmond, J. A. 1995. Macrogeographic genetic variation in populations of the webbing coneworm (Lepidoptera: Pyralidae). *Journal of Entomological Science* 30: 349–358.
- Roling, M. 1985. The miller, the wax worm, the wax moth. *Gleanings in Bee Culture*, January: 39–40.
- Sweeney, B. S., D. H. Funk and R. L. Vannote. 1987. Genetic variation in stream mayfly (Insecta: Ephemeroptera) populations of eastern North America. *Annals of the Entomological Society of America* 80: 600–612.
- Vrijenhoek, R. C. 1994. Genetic diversity and fitness in small populations. Pp. 35–53, in V. Loeschcke, J. Tomiuk, and S. K. Jain (eds.), *Conservation Genetics*. Basel, Switzerland: Birkhauser Verlag.
- Wade, M. J., and D. E. McCauley. 1988. Extinction and recolonization: their effects on the genetic differentiation of local populations. *Evolution* 42: 995–1005.
- Watt, W. B. 1977. Adaptation at specific loci. I. Natural selection on phosphoglucose isomerase of *Colias* butterflies: Biochemical and population aspects. *Genetics* 87: 177–194.
- Watt, W. B. 1994. Allozymes in evolutionary genetics: self-imposed burden or extraordinary tool? *Genetics* 136: 11–16.
- Weir, B. S. 1996. *Genetic Data Analysis II: Methods for Discrete Population Genetic Data*. Sunderland, Massachusetts: Sinauer Associates, Inc. xii+445 pp.
- Wright, S. 1951. The genetical structure of populations. *Annals of Eugenics* 15: 323–354.
- Wright, S. 1978. *Evolution and the Genetics of Populations. Volume 4, Variability Within and Among Natural Populations*. Chicago, Illinois: University of Chicago Press. 580 pp.

A New Species of *Diadasiopus* (Acari: Acaridae) Associated with *Diadasia chiliensis* (Hymenoptera: Apidae) in Chile

By

BARRY M. O'CONNOR¹ AND GERALD DANESHVAR¹

ABSTRACT A new species of acarid mite, *Diadasiopus alexanderi*, is described from deutonymphs collected from the emphorine bee, *Diadasia chiliensis*, from six localities in central Chile. The new species is distinguished from the North American *D. eickworti* by the absence of pretarsus IV and tarsal seta *aa* I as well as other morphometric characteristics.

Keywords: Bee mite; Phoresy; Horstiinae; Emphorini; Solitary bee.

INTRODUCTION

O'Connor (1996) proposed the genus *Diadasiopus* for deutonymphs of a new species, *D. eickworti*, collected from the emphorine bee, *Diadasia opuntiae* Cockerell in California. Examination of specimens of other species of *Diadasia* has yielded additional records and new species of this genus of mites. In the present paper, we describe an unusual new species associated with *D. chiliensis* (Spinola) from the Andean region of South America. The species is dedicated to our colleague, the late Byron Alexander, who was studying *Diadasia* at the time of his death, and who provided many of the specimens used in our study. In the following description, all measurements are given in micrometers (μm). Lengths of setae and solenidia are given for the holotype specimen.

ACKNOWLEDGMENTS

The late Byron Alexander, Snow Entomological Museum, University of Kansas, provided mite-bearing bees for this study. Additional material was provided by Brian Brown and Roy Snelling, Los Angeles County Museum, Los Angeles. Ted Jaekel, Camille Angleys and Jason Steinberg assisted in preparing the mite specimens. Funding for this project was provided by a Research Experience for Undergraduates supplement to a grant to BMOC from the National Science Foundation (PEET program) (NSF-DEB 9521744).

Diadasiopus alexanderi

O'Connor & Daneshvar, new species

(Figs. 1–10)

Description.—Deutonymph. Body broadly rounded, length of holotype, mean, range of 43 specimens 172, 163 (143–180); width 113, 107 (92–121). Gnathosoma consisting of well-developed rounded subcapitular remnant bearing greatly reduced palpal remnants apically. Each palpal

remnant (only a slight elevation on subcapitulum) bears apical palpal solenidion (length 23), dorsal palpal tibial seta (length 13); palpal supracoxal seta absent.

Dorsum (Fig. 1). Sejugal furrow present. All dorsal setae filiform. Propodosoma with internal vertical setae (*vi*—length 16) about twice as long as external verticals (*ve*—length 9); external scapular setae (*sce*—length 46) 3.3 times longer than internal scapulars (*sci*—length 14); lengths of hysterosomal setae *c*₁, 10; *c*₂, 16; *cp*, 23; *c*₃, 15; *d*₁, 8; *d*₂, 17; *e*₁, 7; *e*₂, 17; *f*₂, 14; *h*₁, 8; *h*₂, 15; *h*₃, 24. Supracoxal seta of leg I (*scx*) filiform, length 14. Propodosoma mostly covered by weakly defined sclerite; sclerite with distinct pattern of longitudinal to oblique lines. Internal vertical setae (*vi*) at body apex anterior to sclerite, external vertical setae (*ve*) slightly posterolateral to internal verticals. External scapular setae distinctly posterolateral to internal scapulars. Hysterosomal sclerite poorly defined, weakly sclerotized, with distinct longitudinal lines covering sclerite. Setae *c*₂ approximately on same transverse line as *c*₁, other setae as in Fig. 1. Cupule *ia* posteromedial to seta *c*₂, *im* posterior to opisthotal gland opening (*gla*), *ip* on ventral surface lateroventral to seta *e*₂, *ih* ventrolateral to attachment organ. Opisthotal gland opening anterolateral to setae *d*₂.

Venter (Fig. 2). Coxal fields very weakly sclerotized. Anterior coxal apodemes I fused posteromedially into long sternal apodeme with slightly bifurcate end. Posterior apodemes I fused with anterior apodemes II. Anterior apodemes II curve strongly posterolaterally, not fused with posterior apodemes II. Posterior apodemes II less well-sclerotized than others, ending freely. Anterior apodemes III extending around trochanters laterally, medial portion curved posteriorly, fused with anterior apodeme IV. Anterior apodemes IV anteriorly directed, fused with anterior apodeme III, each apodeme with a very weakly sclerotized element extending posteriorly from mid-section, fusing to

¹ Museum of Zoology and Department of Biology, The University of Michigan, Ann Arbor, MI 48109–1079. E-mail: bmoc@umich.edu

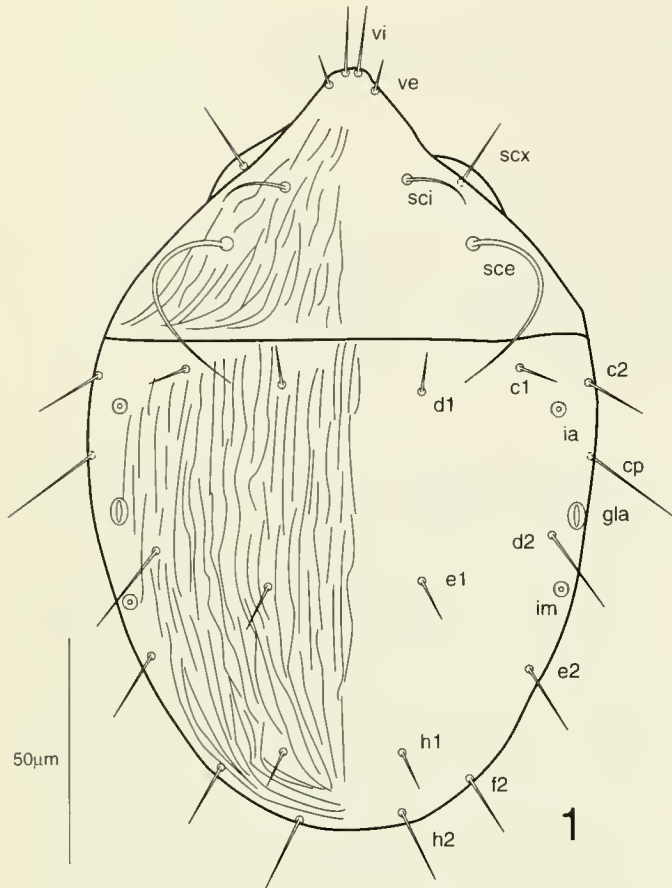

Fig. 1. *Diadasiopus alexanderi* n. sp., Deutonymph, dorsum.

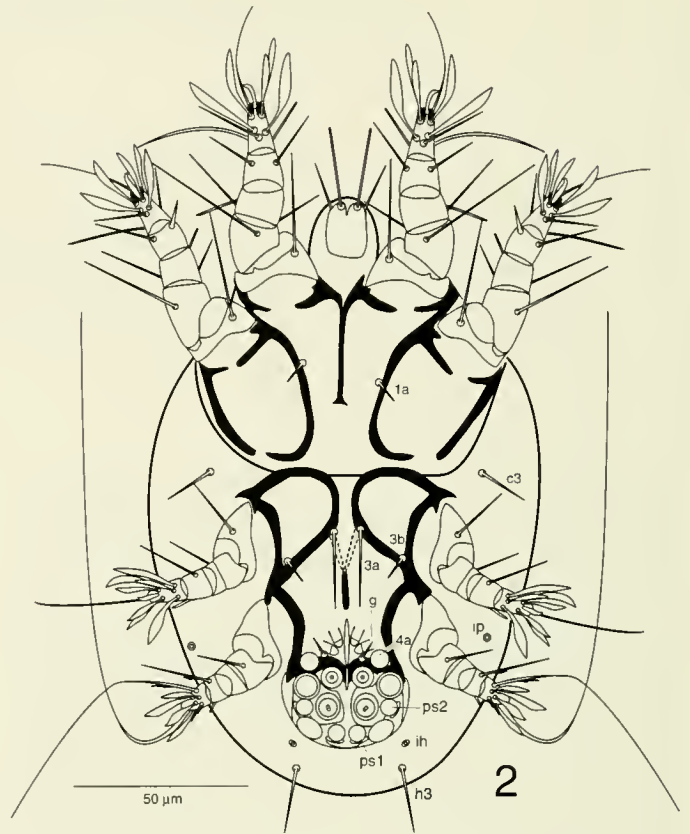

Fig. 2. *Diadasiopus alexanderi* n. sp., Deutonymph, venter.

form a short, more strongly sclerotized median apodeme. Pair of large apodemes extending posteriorly from coxae IV, fused with lateral apodeme extending under attachment organ. Coxal setae *1a*, *3b*, *g* filiform, approximately equal in length, seta *3a* filiform, over twice as long as *3b* (length 20), setae *4a* conoidal; lengths in holotype: *1a*, 7; *3a*, 20; *3b*, 7. Genital setae positioned lateral to posterior end of genital opening, length 9. Both pairs of genital papillae similar, two-segmented, rounded medially. Attachment organ well-developed, with anterior suckers relatively small, median suckers slightly larger; anterior (*ps*₁), posterior (*ps*₂) conoids relatively small, anterior conoids lateral to median suckers, posterior conoids almost contiguous, behind median suckers; anterior lateral, posterior lateral cuticular suckers well-developed.

Legs (Figs. 3–10). Legs relatively short, all segments freely articulating. Lengths in holotype (measured from base of femur to tip of tarsus, I - 55, II - 54, III - 33, IV - 30. Setation (with lengths of filiform setae in parentheses): trochanters with filiform setae *pR* I–II (28–34), *sR* III (20); femora with filiform setae *vF* I (40–43), *vF* II (32–33), *wF* IV (15); genua with filiform setae *mG* I–II (28–30), *cG* I (14–

15), *cG* II (11), *uG* III (16–17); tibiae with filiform setae *gT* I, *hT* I–II (18–21), *gT* II thicker, spinelike (9), *kT* III–IV filiform, *kT* III (22) with almost vestigial basal barbs, barbs on *kT* IV (25) more conspicuous; tarsus I with *wa*, *d* filiform, *la*, *ra*, *p*, *q*, *f* foliate, *aa*, *e*, *ba* I absent; tarsus II similar to I but *ba* present, filiform (17–18); tarsus III with *d* elongate, filiform, *r*, *w*, *s*, *p*, *q*, *e*, *f* foliate; tarsus IV with *r* short, basal spine (8), *w* elongate, filiform, with basal barbs (73), *s*, *p*, *q*, *e* foliate, dorsal seta *d* short spine, terminal seta *f* filiform (127). Solenidia: tarsus I with *ω*1 (15–17) thin, distinctly expanded apically, almost as long as tarsus (15–17), in basal portion of tarsus; *ω*3 (13–16) thinner, positioned on anterior side of tarsus lateral to *ω*1; *ω*2 absent; tarsus II with *ω*1 similar to that on tarsus I; tibiae I–II with *φ* long, filiform (I 43–48, II 34), *φ* III distinctly shorter (12), with rounded tip, *φ* IV very short (4); genua I–II with *σ* thin, (I 37, II 9), *σ* III absent. Pretarsi I–III consisting of relatively long, somewhat hooked empodial claws (I–II 9, III 6–7), with condylophores visible in tarsal apices, empodial claw IV completely absent; membranous ambulacra absent.

Type.—Holotype deutonymph from *Diadasia chiliensis* (Spinola), CHILE: Linares Prov., Cordillera Parral, Fundo

Malcho [Parral at 36°09'S, 71°50'W]; January 1957, L. Peña; host in the Snow Entomological Division, Natural History Museum, University of Kansas (KU), labeled "Mites removed, B. M. OConnor 96-0916-023;" mite specimens bear the same voucher number.²

Paratypes.—All deutonymphs from *D. chiliensis* from Chile, as follows: 12, same data as holotype; 9, same data, (KU), BMOC 96-0916-024; 10, same data, host in the Los Angeles County Museum (LACM), BMOC 97-0331-021; 10, Curicó Prov., Andes Mts., El Coigo, 750–1000m. elev., October–November 1959, L.E. Peña, (LACM), BMOC 97-0331-022; 12, Coquimbo Prov., Hacienda Illapel, 600m. elev., 31°36'S, 71°07'W, 7 June 1954, L.E. Peña, (KU), BMOC 96-0916-025; 10, Coquimbo Prov., Tongoy, 30°15'11"S, 71°29'34"W, 6 January 1956, coll. Wagenknecht, (KU), BMOC 96-0916-026; 3, Coquimbo Prov., Condoriaco, 1350m. elev., 29°42'08"S, 70°49'53"W, 23 November 1955, coll. Wagenknecht, (KU), BMOC 96-0916-027; 7, Coquimbo Prov., El Calabaco, November 1959, (LACM), BMOC 97-0331-020.

Type deposition.—Holotype and 23 paratype deutonymphs deposited in the Snow Entomological Division, Natural History Museum, University of Kansas, Lawrence; 15 paratypes deposited in the Los Angeles County Museum, Los Angeles; 20 paratypes deposited in the Museum of Zoology, University of Michigan, Ann Arbor; 5 paratypes deposited in the Acarology Laboratory, Ohio State University, Columbus; 5 paratypes deposited in the U.S. National Museum of Natural History, Washington; 5 paratypes deposited in the Departamento de Zoología, Universidad de Concepción, Chile.

DISCUSSION

Diadasiopus alexanderi differs from *D. eickworti*, the only

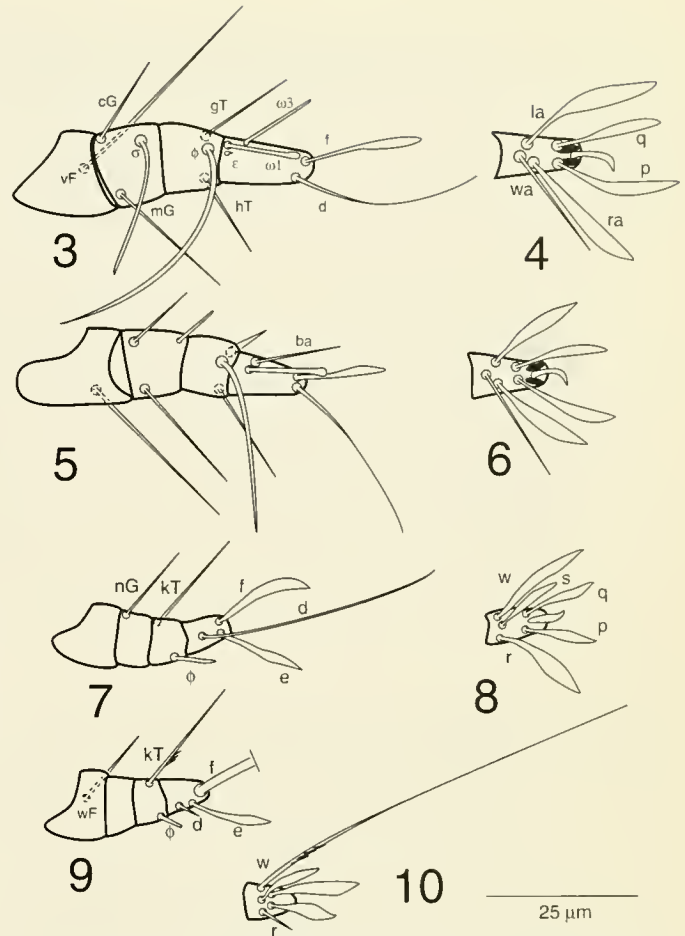

Figs. 3–10. *Diadasiopus alexanderi* n. sp. Deutonymph, legs. 3—Leg I, dorsal. 4—Tarsus I, ventral. 5—Leg II, dorsal. 6—Tarsus II, ventral. 7—Leg III, dorsal. 8—Tarsus III, ventral. 9—Leg IV, dorsal. 10—Tarsus IV, ventral.

² The type host (BMOC 96-0916-023) and one other (BMOC 96-0916-024) in the KU collection are actually labeled as follows: "ARGENTINA—Córdoba, Fundo Malcho, Jan. 1957 (L. Peña)." The specimen from the LACM (BMOC 97-0331-021) is labeled: "Fundo Malcho—Cord. Parral, Chile—Jan. 1957. L. E. Peña—collector." Fundo Malcho (=Malcho farm) could not be located in existing gazetteers of either Chile or Argentina. As a professional collector, Peña shipped large numbers of insect specimens to North American museums in the 1950's, typically unprepared and with field labels only. Correspondence in the archives of the Insect Division of the University of Michigan Museum of Zoology between Peña and L. K. Gloyd dated 18 March 1957 accompanied specimens collected in January 1957. One locality is listed as follows: "Malcho: Andean forestic region in Parral." It seems likely that the specimens of *Diadasiopus chiliensis* ultimately deposited in the KU and LACM collections may have been collected during the same field expedition. Field labels may have borne the abbreviation "Cord." as printed on the label of BMOC 97-0331-021 in the LACM. This could have been misinterpreted as the Argentine province of Córdoba, rather than as Cordillera. The label on the LACM specimen and the correspondence in the UMMZ collection indicate that the type locality is actually in the mountains around Parral, Chile, rather than in the central Argentine province.

other described species in the genus, by a number of characteristics. Loss of pretarsus IV and seta *aa* of tarsus I are highly unusual and require some emendation of the original generic diagnosis. The new species is the only species in the family Acaridae in which a non-regressive deutonymph lacks the pretarsus on leg IV. In most acarid deutonymphs, the empodial claws of all four pretarsi are similar in shape and size. Among certain other bee-associated genera, some reduction in the posterior empodial claws is observed. In *Horstia*, empodial claws III–IV are shorter and less hooked than those of legs I–II. In *Sennertionyx*, empodial claw IV is distinctly smaller than those of legs I–III. In *Diadasiopus eickworti*, empodial claws I–II are similar in size, empodial claw III is somewhat smaller, and empodial claw IV is smaller still.

In other acarid mites, tarsal seta *aa* I is typically either consistently present in all species in a genus, or absent in all. Loss of this seta in *D. alexanderi* and its retention in *D. eickworti* is an unusual situation.

Other distinguishing features of the new species include the smaller body size, filiform dorsal setae (mostly spine-like in *D. eickworti*), relatively longer *vi* setae (twice as long as *ve*, both similar in length in *D. eickworti*), similar lengths of coxal setae *1a* and *3b* (*1a* distinctly longer than *3b* in *D. eickworti*), fusion of the posterior medial extensions of anterior apodeme IV to form a median apodeme

(unfused in *D. eickworti*). Certain leg setae are relatively longer in the new species when compared with *D. eickworti*; these include *nG* and *kT* III, *kT* IV, *w* and *f* IV.

LITERATURE CITED

- OConnor, B.M. 1996. Two new mites (Acari: Acaridae) associated with long-tongued bees (Hymenoptera: Apidae) in North America. *Journal of the Kansas Entomological Society* 69 (4) suppl.: 15-34.

Life on the Edge: Object Orientation and Aquatic Locomotion in *Paederus arduus* Sharp (Coleoptera: Staphylinidae)

By

SANDRA HAASE-STATZ^{1,2} AND ELIZABETH F. SMITH¹

ABSTRACT Male and female *Paederus arduus* beetles were collected from marsh vegetation and brought into the laboratory for characterization of their aquatic locomotion abilities and shoreline orientation preferences. Frame-by-frame analysis of videotape showed that *P. arduus* maneuvers easily on the water surface using a normal tripod gait. It also uses the down-turned tip of its abdomen as a 'keel' to assist in stabilization, turning, and possibly braking. When beetles were placed in a water-filled arena and allowed to orient toward light areas (water horizon), dark areas (land horizon), or vertical light-dark edges (emergent vegetation), they consistently chose edges over solid areas, a response that intensified when the edge stimulus was enhanced. There were no detectable differences between male and female responses. *Paederus arduus* maneuvers capably on the water surface and shows strong orientation toward visual patterns consistent with those produced by emergent vegetation. These abilities and responses are probably adaptive for an insect living in riparian areas.

Keywords: Coleoptera; Staphylinidae; Paederinae; *Paederus arduus*; Behavior; Orientation; Vision; Locomotion; Gait.

INTRODUCTION

The ability of many invertebrates to identify objects in their environments and orient toward them is well known (Cole, 1980; Hamilton, 1977, 1978; Hamilton and Winter, 1982; Jander, 1963b and references cited therein). Depending upon the needs of the animals, they may orient toward broad light areas, broad dark areas, horizontal edges, or vertical edges (Jander, 1971). Additionally, it is known that some terrestrial invertebrates with aquatic locomotive abilities utilize different gait patterns in the water from those used for terrestrial locomotion (Caponigro and Eriksen, 1976; Franklin et al., 1977; Miller, 1972). The change in gait offers a more efficient means of movement (Franklin et al., 1977).

Most *Paederus* species inhabit riparian habitats, such as the edges of marshes, freshwater lakes, streams, and flood plains, at all altitudes and on all continents except Antarctica (Frank and Kanamitsu, 1987). However, natural histories have been described for only a handful of the over 600 described species, and in only one species, *P. rubrothoracicus* Goeze, has aquatic navigation been examined (Heberdey, 1944; Ercolini and Badino, 1961).

Life history studies of *Paederus* spp. indicate they are generalist predators that are typically found in litter or in relatively dense vegetation, where they feed on various dipteran larvae and immature Hemiptera (Ahmed, 1957; Focarile, 1964; Kurosa, 1958; Haase-Statz, 1995). They are univoltine in the temperate regions and bivoltine in the

tropics (Frank and Kanamitsu, 1987). Eggs are laid on the soil surface; there are two larval instars, and larvae mature in approximately 4 weeks under laboratory conditions (Ahmed, 1957; Kurosa, 1958; Manley, 1977; Haase-Statz, unpublished data).

Individuals of *Paederus arduus* Sharp were observed in swamp areas at La Selva Biological Research Station in Costa Rica. During the day, adults were active on the emergent vegetation, walking up and down the stems and between adjacent plants where leaves touched. At night the beetles were quiet, becoming active only if molested or exposed to artificial light for a prolonged period. Individuals were not observed on the water unless disturbed, but when displaced to the surface, they traveled across it quickly and with ease. This *Paederus* species has strongly-veined but short wings, approximately 1.5× elytral length (compared to 2× or more in a typical flying species). *P. arduus* may be capable of flight, but we never observed any individuals flying and were unable to induce them to fly.

All available natural history information on *Paederus* spp. indicates that females, at the very least, would need to be on land at some point in their life cycle, i.e., for oviposition. Time limitations made it impossible to determine whether *P. arduus* regularly travels to shore or even travels across water under normal circumstances. Assuming, however, that individuals might at some point find themselves on the water surface (either by accident or intent), we wondered whether *P. arduus* would exhibit natural

¹ Department of Entomology, Haworth Hall, University of Kansas, Lawrence, KS 66045.

² Present address: Department of Entomology, University of Wisconsin-Madison, Madison, WI 53706. E-mail: statz@entomology.wisc.edu

shoreline orientation. Specifically, we wanted to test whether individuals, if placed in a water-filled arena, would preferentially orient toward a broad dark area (indicative of shoreline), a broad light area (water horizon), or areas of vertical dark-light contrast (edges of plant stems). We also wanted to determine whether *P. arduus* would employ a normal terrestrial tripod gait for propulsion.

ACKNOWLEDGMENTS

Thanks to M. Greenfield, C. Morse, and A. Slaymaker for help with beetle capture and data collection. We are indebted to N. Slade and M. Greenfield for statistics advice. We thank M. Greenfield for review of an early draft of the manuscript, and we appreciate the thoughtful comments of two anonymous reviewers. J. H. Frank and J. S. Ashe provided identification assistance. We thank the Hungerford Fund, the Department of Entomology, the Panorama Society, and the Self Fellowship, all of the University of Kansas, for financial assistance. Finally, with deepest gratitude, we thank Byron Alexander for his inspiration, his enthusiastic teaching, and his kind friendship.

METHODS

BEETLE COLLECTION

Two populations of *Paederus arduus* Sharp were found in open swamp areas at La Selva Biological Research Station, Heredia Province, Costa Rica, in June 1996. At both sites, male and female adults were collected from stems of emergent vegetation approximately 20 m from the shoreline but within about 50 cm of the boardwalks traversing the swamps. Twenty-two individuals (15 males, 7 females) were collected. Throughout the course of the two-day study, they were housed individually in 2-oz. plastic containers in an ambient-temperature laboratory and were given access to water but not food.

OBJECT ORIENTATION

The orientation arena was constructed from an oil drum that had been sawed in half. It was 62 cm in diameter and 67 cm deep. The interior was spray painted to provide a white background, and the floor of the arena remained white in all experiments. The wall of the arena was divided into 8 segments of 45° each, which were numbered consecutively. Rectangles of black plastic were placed on the inner wall of the arena to create dark areas and edges (Fig. 1A).

In the first experiment (Normal Edge), a single black panel covered half of the arena such that three contiguous segments (37.5%) were solid black, the three opposite (37.5%) were solid white, and each of the two remaining segments encompassed a black-white interface (total of

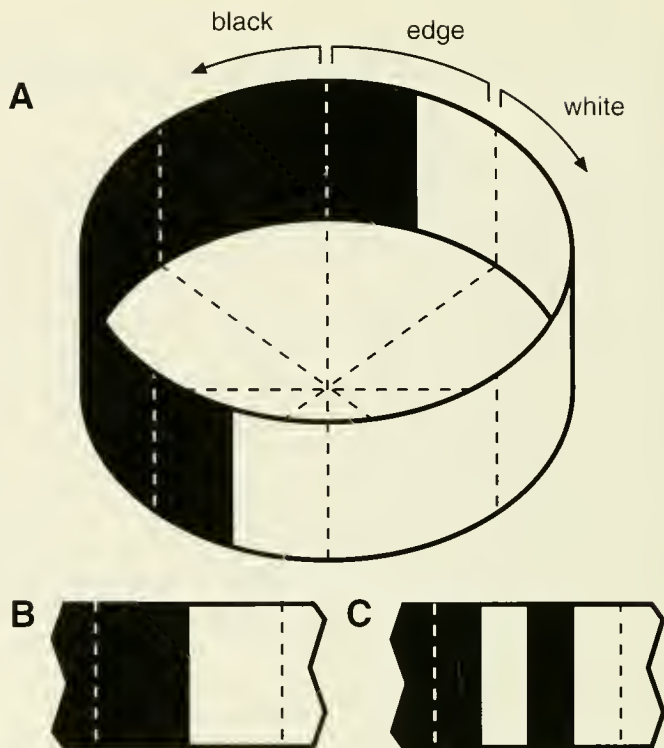

Fig. 1. A—Representation of the test arena as configured in Experiment 1. B—Pattern on 'edge' segment in Experiment 1 (Normal Edge). C—Pattern on 'edge' segment in Experiment 2 (Enhanced Edge). Illustrations are not to scale; see text. Dotted lines represent borders between segments.

25%; Fig. 1B). In the second experiment (Enhanced Edge), the solid panels remained the same, but the two 'edge' segments were modified: each was still 50% black and 50% white, but the colors were redistributed into four 11.25° stripes; therefore, the effective number of edges in each of the segments was increased from one to three (Fig. 1C).

The arena was filled with water to approximately 30 cm deep. A 60-watt incandescent light was suspended above the center of the arena to minimize light variation. In each trial, the beetle was placed on the water surface in the center of the arena, and its response was recorded based on the segment number where it first touched the wall. Each individual was used in four trials, with the arena turned 90° clockwise after each trial to control for any possible cues external to the arena. The same individuals were used in Experiments 1 and 2.

Data for each experiment were analyzed by the following methods. A chi-square contingency test, with columns corresponding to the trials and rows corresponding to the three possible segment types, was used to justify combining data from all four trials in analysis; trials were combined when $p \geq 0.10$. The analysis was then divided into two parts: first we tested for preference of edge over

non-edge; then, among non-edge responses, we tested for preference of black or white. 'Number of successes' was counted for each individual, with success defined as 'edge' in the first test and 'black' or 'white' in the second. Male *vs.* female responses were compared using an extension of Fisher's Exact test into a $2 \times k$ table with 'number of successes' as the column variable; male and female data were then combined if $p \geq 0.10$. A binomial-test p-value was calculated for each individual based on its responses and the probability of selecting the given segment by chance (25% in the first test, 50% in the second). The probability calculated was that of achieving the actual result or one more extreme given the null hypothesis of no preference; that is, the value calculated was the reverse cumulative probability ($p [\geq r \text{ successes in } n \text{ trials}]$). The p-values of individuals were then combined using Fisher's method for combining probabilities from independent tests of significance, which uses a chi-square statistic (Sokal and Rohlf, 1995, pp. 794–797). In testing for preference of black *vs.* white, we performed two one-tailed tests; this is simpler than performing a two-tailed test on a discrete asymmetrical distribution.

AQUATIC LOCOMOTION

To evaluate the locomotive gait of *P. arduus* on the water surface, a beetle was filmed laterally and dorsally on both a solid surface and on water, using a video camera. Gait patterns on the solid surface were used as a control to compare with gait patterns on water. The video was evaluated using frame-by-frame advancement. Dorsal views were most revealing, as leg position could be determined by water displacement.

PRESERVATION AND VOUCHER SPECIMENS

All individuals were killed in 95% EtOH. One male and one female were retained in 95% EtOH; two males and two females were relaxed and point-mounted. These six specimens have been deposited in the Snow Entomological Collection, University of Kansas Natural History Museum.

RESULTS AND DISCUSSION

OBJECT ORIENTATION

In both experiments, beetles showed a strong preference for edge panels. In the Normal Edge experiment, beetles chose an edge segment 42 times, a white segment 31 times, and a black segment 15 times out of 88 observations. In the Enhanced Edge experiment, an edge segment was chosen 63 times, white was chosen 15 times, and black was chosen 10 times.

For the first experiment (Normal Edge), a chi-square contingency test revealed no detectable difference in re-

sponse ratios among the four trials ($X^2 = 2.33$, $df = 6$, $p = 0.796$), so all trials were considered equivalent. In the first binomial test (edge *vs.* non-edge), individual probabilities ranged 0.051 (3 out of 4 times to edge) to 1.000 (0 in 4). A 2×4 extension of Fisher's exact test on sex (M or F) *versus* number of successes (0–3) yielded a $p = 0.523$, so data from the two sexes were analyzed together. Combining probabilities for all individuals according to Fisher's method yielded a $p = 0.018$ ($X^2 = 65.82$, $df = 44$). In other words, beetles showed a significant preference for edge over non-edge segments. In the analysis testing preference for black *vs.* white (excluding instances in which an edge was chosen), a 2×3 extension of Fisher's exact test yielded a $p = 0.823$, so male and female data were analyzed together. In a test for preference of black, individual probabilities ranged from 0.250 (2 in 2) to 1.000 (0 in ≤ 3), and for all individuals the combined $p = 1.000$ ($X^2 = 14.02$, $df = 44$). In a test for white, individual probabilities ranged from 0.125 (3 in 3) to 1.000 (0 in ≤ 3), and the combined $p = 0.803$ ($X^2 = 35.90$, $df = 44$). In other words, beetles showed no detectable preference for black or for white.

For the second experiment (Enhanced Edge), a chi-square test showed no differences among trials ($X^2 = 1.68$, $df = 6$, $p = 0.62$), so trials were considered equivalent. A 2×4 extension of Fisher's exact test yielded a $p = 0.524$, so data from both sexes were analyzed together. In the first binomial test (edge *vs.* non-edge), individual probabilities ranged from 0.004 (4 out of 4 times to edge) to 0.684 (1 in 4), and combining probabilities yielded a group $p < 0.001$ ($X^2 = 140.17$, $df = 44$). In other words, beetles showed a highly significant preference for the enhanced edge segments. Eight individuals chose edge segments in every trial; therefore only 14 individuals were used in the binomial test for black *vs.* white. Here, the 2×3 extension of Fisher's exact test showed no difference between females and males, $p = 0.266$, so data were pooled. In the test of preference for black, individual binomial probabilities ranged from $p = 0.500$ (1 in 1) to 1.000 (0 in ≤ 2), and the combined $p = 0.999$ ($X^2 = 9.97$, $df = 28$). In the test of preference for white, individual probabilities ranged from 0.250 (2 in 2) to 1.000 (0 in ≤ 2), and the combined $p = 0.945$ ($X^2 = 17.17$, $df = 28$). As in the previous test, beetles showed no significant preference for black or for white panels.

The orientation behavior of these beetles can only be evaluated in a limited context, due to the study's time frame. It is possible that the orientation behavior may be dependent on season, sex, and age; for example, females might orient toward broad dark areas if placed in water prior to mating or oviposition. However, it is impossible to evaluate the potential seasonality of orientation behavior in this species because there is no information regarding its life history. Orientation behavior could also be in-

fluenced by time of day or weather; however, for beetles displaced into the water in the field, we observed no differences among nocturnal, crepuscular, and diurnal behavior, and no observations were made under varying weather conditions. Therefore, the only conclusion that can be drawn is that during daylight hours in early June, adults of *P. arduus* show an orientation preference toward edges over both broad dark and broad light horizons. Furthermore, intensifying the 'edge' stimulus by the addition of stripes appeared to increase the attractiveness of the edge area. Vertical edges are visually suggestive of stems and other emergent objects, and rapid orientation toward them is most likely a response to potential predation by fish and frogs, which eat insects from the water surface.

AQUATIC LOCOMOTION

No differences were found between the stride pattern used by *P. arduus* for locomotion on water and that used on land. Forward propulsion on the water utilized an alternating tripod gait, in which the prothoracic and metathoracic legs on one side of the body and the mesothoracic leg of the other side of the body are down simultaneously.

However, when the beetles were initially placed on the water surface, a short period of scrambling occurred prior to the more methodical alternating tripod pattern. The legs moved more rapidly during the scrambling and there was no forward propulsion with this action. Due to the speed of the leg movement, it was not possible to determine whether the alternating tripod pattern was in use during scrambling.

Differences in the use and position of the abdomen were noted during forward propulsion. Specifically, the abdomen was curled ventrad with the abdominal apex placed on the water surface as opposed to curved dorsad as is commonly seen during terrestrial locomotion. The potential purpose of this behavior can be divided into three generalized functions: stabilization, turning, and slowing down.

There were two instances in which the beetle seemed to use the abdomen for stabilization. First, when the beetle initially found itself on the water surface, the abdomen was extended with its tip contacting the surface. The metathoracic legs were held still, splayed out and backward, and the pro- and mesothoracic legs moved rapidly (we were unable to determine the pattern) as the beetle established traction. After gaining traction, the beetle switched to a tripod pattern and forward movement began. During forward movement, the abdomen was sometimes curled dorsad, as is typical of many staphylinids as they run on land, and was sometimes curled ventrad with the tip dragging on the water surface. The tip of abdomen was also

used for stabilization during grooming; metathoracic and mesothoracic legs were held still and splayed out and backward while the prothoracic legs were groomed with the mandibles. The grooming of the prothoracic legs may be necessary for removing excess water from the heavily setose tibiae and tarsi.

The beetle also used the downturned abdomen as a keel on the water, pivoting on it to turn and turning the head in the direction of the abdomen to change course. The same technique is also used by some grasshoppers (Franklin et al., 1977).

The use of the abdomen as a brake for slowing down was the most difficult to evaluate. The abdomen was always brought down as the beetle approached an edge, which subsequently slowed its momentum. However, the beetle usually discontinued all leg movements simultaneously and glided to the edge of the arena. Based on the video footage, it is impossible to determine whether placement of the abdomen on the surface of the water as the beetle approaches an object functions primarily to decrease speed or primarily to provide stabilization as the beetle glides toward the edge.

One other curious habit was noticed: the beetles could balance on the water surface using only the pro- and mesothoracic legs. They assumed this position while stroking the abdomen with the metathoracic legs. Unlike the grooming of the prolegs, the purpose of this behavior is less obvious. The metathoracic legs are not heavily setose; therefore, it is unlikely that water build-up would be a problem. This behavior is common among several other species of *Paederus* prior to copulation (in both males and females) and prior to oviposition (Haase-Statz, personal observation). One hypothesis is that the gland located between the third and fourth abdominal sterna (Kellner and Dettner, 1992) secretes a chemical that alters the surface tension of the water, allowing the beetles to move more efficiently across the surface. Thus, the behavior of rubbing the metathoracic legs along the sides of the abdomen might help distribute this chemical from the gland opening to the tip of the abdomen and subsequently to the water surface. This was previously proposed to explain the ability of *P. rubrothoracicus* to run on the water surface (Jarrige, 1944). The release of a chemical to alter the surface tension for locomotion has been shown in *Stenus* (Coleoptera: Staphylinidae) (Jander, 1963a), but there is no physical evidence for it in *Paederus* spp.

CONCLUSION

From this study, we may conclude that when displaced into the water, *P. arduus* orients preferentially toward areas of vertical light-dark contrast, which are suggestive of plant stems. This response is probably adaptive for an in-

sect living in marshy habitats. It would be interesting to determine whether this beetle shows similar orientation preferences in a 'terrestrial' arena. We may also conclude that *P. arduus* can easily travel across the surface of the water using a standard tripod gait, and that its motion is aided by placement of the tip of the abdomen on the water surface during stabilization, turning, and possibly braking. The ventrad curving of the abdomen and its associated behaviors merit further study.

LITERATURE CITED

- Ahmed, M. K. 1957. Life history and feeding habits of *Paederus alferii* Koch. Bulletin of the Entomological Society of Egypt 41: 129-143.
- Caponigro, M. A. and C. H. Eriksen. 1976. Surface film locomotion by the water strider *Gerris remigis*. American Midland Naturalist 95: 268-278.
- Cole, S. L. 1980. Cross-shoreline orientation in three species of shore-dwelling insects. Ph. D. dissertation. University of Kansas, Lawrence, Kansas. 69 pp.
- Ercolini, A. and G. Badino. 1961. L'orientamento astronomico di *Paederus rubrothoracicus* Goeze (Coleoptera-Staphylinidae). Bollettino de Zoologia 28: 421-32. [in Italian]
- Focarile, A. 1964. Ecologia e geonemia di *Paederus* (s. str.) *melanurus* Arag. (Coleoptera, Staphylinidae). Memorie della Societa Entomologica Italiana 42: 80-96. [in Italian]
- Frank, J. H. and K. Kanamitsu. 1987. *Paederus*, sensu lato (Coleoptera: Staphylinidae): natural history and medical importance. Journal of Medical Entomology 24: 155-191.
- Franklin, R., R. Jander, and K. Ele. 1977. The coordination, mechanics and evolution of swimming by a grasshopper, *Melanoplus differentialis* (Orthoptera: Acrididae). Journal of the Kansas Entomological Society 50: 189-199.
- Haase-Statz, S. L. 1995. Taxonomy and natural history of North American *Paederus* (Coleoptera: Staphylinidae) north of Mexico. M. S. thesis. University of Wisconsin-Madison, Madison, Wisconsin. 84 pp.
- Hamilton, P. V. 1977. Daily Movements and visual location of plant stems by *Littorina irrorata* (Mollusca: Gastropoda). Marine Behavior and Physiology 4: 293-304.
- Hamilton, P. V. 1978. Adaptive visually-mediated movements of *Littorina irrorata* (Mollusca: Gastropoda) when displaced from their natural habitat. Marine Behavior and Physiology 5: 255-271.
- Hamilton, P. V. and M. A. Winter. 1982. Behavioural responses to visual stimuli by the snail *Littorina irrorata*. Animal Behavior 30: 752-760.
- Herberdey, R. F. 1944. Ein Wasserläufer unter den Käfern (*Paederus rubrothoracicus* Gze.). Zeitschrift für Morphologie und Oekologie der Tiere 40: 361-76. [in German]
- Jander, R. 1963a. Das Spannungsschwimmen von *Velia* und *Stenus*. Naturwissenschaften 6: 1-2. [in German]
- Jander, R. 1963b. Insect orientation. Annual Review of Entomology 8: 95-114.
- Jander, R. 1971. Visual pattern recognition and directional orientation in insects. Annals of the New York Academy of Science 188: 5-11.
- Jarrige, J. 1944. Les *Paederus* de France. Entomologiste 1: 5-9. [in French]
- Kellner, L.L. and K. Dettner. 1992. Comparative Morphology of abdominal glands in Paederinae (Coleoptera: Staphylinidae). International Journal of Insect Morphology and Embryology 21: 117-135.
- Kurosa, K. 1958. Studies on poisonous beetles. III. Studies on the life history of *Paederus fuscipes* Curtis (Staphylinidae). Japanese Journal of Sanitary Zoology 9: 8-12.
- Manley, G. V., 1977. *Paederus fuscipes* (Col. Staphylinidae): a predator of rice fields in West Malaysia. Entomophaga 22: 47-59.
- Miller, P. L. 1972. Swimming in mantids. Journal of Entomology 46: 91-97.
- Sokal, R. R. and F. J. Rohlf. 1995. *Biometry* (3rd ed.). W. H. Freeman and Company, New York. xix + 887 pp.

Odyneropsis, a Genus New to the United States, with Descriptions of Other New Cleptoparasitic Apidae (Hymenoptera: Apoidea)

By

TERRY GRISWOLD¹ AND FRANK D. PARKER¹

ABSTRACT *Odyneropsis apache* n. sp. represents the first record from the United States of this otherwise neotropical genus. Three other cleptoparasitic Apidae are described: *Melecta alexanderi* and *Neolarra ute* from the San Rafael Desert, Utah, USA, and *Neolarra alexanderi* from the Chihuahuan Desert, northern Mexico.

Keywords: Colorado Plateau; Great Basin; Chihuahuan Desert; Epeolini; Neolarrini; Melectini; Parasitic bee.

INTRODUCTION

Byron Alexander had both a keen interest in parasitic Apidae and a love of the deserts of the Southwest. Accordingly, it seems most fitting to recognize him in recording the following new species of parasitic bees from the southwestern United States and northern Mexico, names of which are needed for ongoing faunal studies.

In the descriptions that follow, the following abbreviations are used: F1, F2, ... for the segments of the antennal flagellum, T1, T2, ... and S1, S2, ... for the tergal and sternal segments respectively of the apparent metasoma. Types are deposited in the U.S. National Pollinating Insects Collection, Logan, Utah except as indicated.

ACKNOWLEDGMENTS

We gratefully acknowledge the loan of material by the late Floyd Werner, University of Arizona, Tucson, and permission by the present curator, Carl Olson, to deposit types at Logan. Thanks to Rebekah Andrus and George Bohart for reviewing the manuscript. This is a contribution from Utah Agricultural Experiment Station, Utah State University, Logan, Utah 84322-4810, Journal Paper No.7032 and USDA-ARS Bee Biology and Systematics Laboratory.

Odyneropsis apache new species

Female.—Length, 17 mm; length of forewing, 14 mm. Body reddish brown, darker apically on terga. Apex of mandible, tarsal claws black. Wings dark brown throughout, darkest in radial cell. Pubescence light. **Head:** Galea no longer than eye length. Mandible without inner tooth, but with low obtuse angle. Labrum twice as broad as long. Clypeus contiguously punctate except for narrow apical rim; median longitudinal carina for full length of clypeus; clypeus not strongly protruding, in lateral view one-half eye width. Frons and vertex densely punctate throughout. Ocelli not greatly enlarged, diameters slightly less than

flagellar width. Gena broad, nearly as wide as eye in lateral view; densely punctate throughout. **Thorax:** Pronotal collar with transverse dorsal carina extending for short distance on each side of midline. Scutellum with obtuse submedian angle posteriorly. Axilla elongate, with slender spine nearly as long as axillar-scutellar suture; with dorsal carina for almost entire length. Metanotum slightly protuberant, convex medially. Mesopleuron densely but not contiguously punctate. Midtibia with strong outer apical longitudinal carina. **Abdomen:** Terga coarsely punctate. T5 with oval depressed area on disk almost circular, surrounded by carina, apical margin of T5 angularly emarginate; pseudopygidial hairs separated except for narrow band along apical margin. Pygidium nearly as broad as long, lateral margins converging on truncate apex. Sterna densely punctate.

Male.—Length, 15–16 mm; length of forewing, 14 mm. As in female except: Hind basitarsus slender, parallel-sided. Pygidial plate parallel-sided to broadly rounded apex. Pubescence of S3–5 not overhanging sternal margins. S7 deeply notched. S8 produced to rounded right angle.

Type material.—Holotype female: USA, Arizona, Santa Cruz Co., Sycamore Canyon, near Ruby, 16–17 Aug 1961, Werner, Bequaert. Paratypes: 1 male, same data as holotype except J.C. Bequaert; 1 male, USA, Arizona, Pima Co., Box Canyon, Santa Rita Mts., 6 mi NW Greaterville, 28 July 1970, D.P. Levin. Holotype in the Logan collection, paratypes in Logan and University of Arizona, Tucson.

Distribution.—Known only from southeastern Arizona.

Discussion.—The combination of reddish-brown body, entirely dark wings, elongate axillae and dull, densely punctate terga will distinguish *Odyneropsis apache* from other members of the genus. All of the other *Odyneropsis* known to occur in North America (*O. apicalis* Ducke, *O. batesi* Cockerell, *O. columbiana* Schrottky, *O.*

¹ USDA-ARS Bee Biology & Systematics Laboratory, Utah State University, Logan, UT 84322-5310. E-mail: tgris@cc.usu.edu

gertschi Michener) are black-bodied. In *Odyneropsis apicalis* and *O. columbiana* the apices of the forewings are clear, contrasting with the darkly stained basal portion. *Odyneropsis batesi* has white appressed hair obscuring the posterior face of the propodeum and the basal portion of T1. *Odyneropsis gertschi* has shiny terga with T2–4 sparsely punctate.

Odyneropsis apache is the most northerly *Odyneropsis*, representing the first record of this genus from the United States. The northern limits of *Odyneropsis* mirror those of its known host, *Ptiloglossa*, which is represented in south-eastern Arizona by *P. arizonensis* Timberlake and *P. jonesi* Timberlake.

Melecta alexanderi new species

Female.—Length, 15 mm; length of forewing, 13 mm. Body black except mandibles yellowish apically. Wings dark brown, darkest in cells. Pubescence black without blue tints except rust-colored on vertex, dorsum of thorax; band on T1 gradually narrowed toward midline, narrowly interrupted medially. *Head*: Labrum with low, shiny longitudinal ridge. F1 slightly longer than F2. Frons uniformly punctate, without impunctate area below midocellus. Vertex with small impunctate area posterolateral to lateral ocellus. *Thorax*: Posterior spine on lateral lobe of scutellum moderately long. Midtibial spur strongly hooked apically. Hindtibia greatly broadened apically, almost one-half as wide apically as long. *Abdomen*: Terga appearing dull due to very dense punctation and pubescence. T1–4 without apical impunctate zones. Pygidium broad, gradually tapering to rounded apex. S2–3 with wide impunctate margins except for obscure median line of weak pubescence.

Male.—Length 11–13 mm; length of forewing, 10–12 mm. Color, pubescence, and punctation as in female except light pubescence dark yellow. *Head*: Antennal flagellar segments without pit-like sensoria. *Thorax*: Scutellar spine long. Midtibia without light pubescence on outer face. Hindbasitarsus nearly parallel-sided, widest at midpoint, somewhat narrowed at base. *Abdomen*: T7 without evident pygidial area, apex narrowly truncate without or with shallow notch. S4–5 without subapical hair brushes.

Type material.—Holotype female: USA, Utah, Wayne Co., 4 mi N Hanksville, N airport, 4500 ft, 12 May 1991, T. Griswold. Paratypes: 1 female, USA, Utah, Emery Co., 4 air mi N Gilson Butte, 5100 ft, 5–7 May 1981, *Cryptantha flava*, Veirs, Griswold, Bohart; 1 female, Utah, Tooele Co., East Dugway Dunes, Dugway Proving Grounds, 20 May 1997, T. Toler; 1 male, same except North Wig Dunes, 21 May 1997; 1 female, same except 4 June 1997; 1 male, Nevada, Lander Co., Campbell Creek Ranch, 14 June 1981, ethylene glycol pitfall trap, J. B. Knight. Types in Logan

collection.

Distribution.—Apparently endemic to the Colorado Plateau and Great Basin.

Discussion.—*Melecta alexanderi* belongs in the subgenus *Melecta* as defined by Linsley (1939). It can be distinguished from other nearctic *Melecta* by the dark, heavily stained wings and shiny longitudinal ridge of the labrum. In addition, the combination of F1 longer than F2, frons without impunctate area below median ocellus, rather dull, densely punctate terga, and wide impunctate margins of S2–3 (but not S4) is distinctive. Females run to *M. pacifica* Cresson in Hurd and Linsley's key (1951), which is described as a key to California species but includes all North American species. They differ most noticeably in the dark wings and broad pygidium. Males also run to *M. pacifica* in Hurd and Linsley's key except for the character related to T7. They differ from *M. pacifica* in the dark wings, long scutellar spines, and densely punctate, dull appearing terga.

Neolarra alexanderi new species

Male.—Length, 3 mm; length of forewing, 2 mm. Black except mandible apically, apical margins of terga, sterna reddish; mandible except apically, labrum, clypeus, antenna, pronotal lobe, and legs except coxae pale yellow. Wings clear, veins pale yellow except reddish stigma. Pubescence entirely white, dense over most of body, completely concealing integument on lower face to middle of frons, upper gena, mesopleuron, scutellum posteriorly, metanotum medially, fore and hindcoxae anteriorly, outer faces of mid and hindtibiae, posterior margins of terga. *Head*: Mouthparts short, not visible beyond mandibles in repose, not attaining posterior margin of fossa. Mandible long, reaching opposite margin of fossa in repose. Inner orbits of eyes distinctly converging ventrally. Antenna with F1 broader than long, F8–9 as long as broad. *Thorax*: Lateral angle of pronotum prominent, slightly curved anteriorly. Axilla no longer than broad, slightly curved to acute posterolateral point, long axis of segment approximately 35° from longitudinal axis of body. Metanotum scarcely projecting medially. Forewing with marginal cell longer than margin of stigma on submarginal cell. Recurrent vein joining submarginal cell two-thirds distance from base to apex. *Abdomen*: Apical process of T7 very slender, with longitudinal ridge except at tip, thus thickened in lateral view.

Female.—Length, 3.4 mm; length of forewing, 2.2 mm. As in male except: Oblong dark region centrally on disk of T5. Antenna with F1 as long as broad, F7–9 more than two times as wide as long. Apical margin of T5 not incurved. Pygidial plate broad, lateral margins not thickened, straight, converging slightly toward apex, apical margin strongly notched.

Type material.—Holotype male: MEXICO, Chihuahua, Samalayuca, 22 Sep 1970, G.E. & R.M. Bohart. Paratypes: 6 males, 8 females, same data. Types in the Logan collection.

Distribution.—Chihuahuan Desert of northern Mexico.

Discussion.—*Neolarra alexanderi* is a member of the subgenus *Phileremulus* Cockerell, and runs to *N. vigilans* (Cockerell) in Shanks' key (1978). As indicated in the discussion of *N. vigilans* (Shanks, 1978), it is a highly variable complex with a range of states for a number of characters used elsewhere in the genus to distinguish species. Additional material now available suggests that *N. vigilans* is actually a species complex. *Neolarra alexanderi* is one of the most distinctive of these segregates. It can be distinguished from all other species of *Phileremulus* by the shortened mouthparts. The combination of terga densely pubescent throughout with indistinct apical tergal bands, the short, diagonally-directed axillae, thickened flagellum, slender, but dorsoventrally thickened, apical process of male T7, and the form of the female pygidial plate will serve to distinguish it from all but *N. ute*, described below.

Neolarra ute new species

Male.—Length, 3.5–5 mm; length of forewing, 2.5–3 mm. Black except terga, sterna, trochanters and femora in part, tibiae reddish; mandible except apically, labrum, clypeus, antennae, pronotal lobe and tarsi yellow. Wings clear, veins yellow except dark stigma. Pubescence entirely white, dense over most of body, completely concealing integument on lower face to middle of frons, upper gena, mesopleuron, scutellum posteriorly, metanotum medially, fore and hindcoxae anteriorly, outer faces of mid and hindtibiae, and posterior margins of terga. **Head:** Mouthparts long, visible beyond mandibles in repose, slightly exceeding posterior margin of fossa. Mandible long, reaching opposite margin of fossa in repose. Inner orbits of eyes distinctly converging ventrally. Antenna with F1 broader than long, F8–9 slightly longer than broad. **Thorax:** Lateral angle of pronotum prominent, distinctly curved anteriorly. Axilla no longer than broad, curved to acute posterolateral point, long axis of segment approximately 50° from longitudinal axis of body. Metanotum scarcely projecting medially. Marginal cell longer than margin of stigma on submarginal cell. Recurrent vein joining submarginal cell two-thirds distance from base to apex. **Abdomen:** Apical process of T7 very slender, with longitudinal ridge except at tip, thus thickened in lateral view.

Female.—Length, 4–5 mm; forewing length, 2.5–3 mm. As in male except: Oval dark spot centrally on disk of T5.

Antenna with F1 as long as broad, F7–9 two times as wide as long. Apical margin of T5 slightly incurved. Pygidial plate broad, lateral margins not thickened, straight, converging slightly toward apex, apical margin strongly notched.

Type material.—Holotype male: USA, Utah, Emery Co., 2 mi E Little Gilson Butte, 24–26 Aug 1981, Veirs, Griswold, Parker. Paratypes: USA, Utah, San Juan Co.: 1 female, (label error as Garfield Co.), Grand Gulch, Hall Creek, 4500 ft, 22 Aug 1980, A.S. & K.A. Menke, F.D. Parker. Grand Co.: 1 female, Bartlett Flat, N Deadhorse Point, 5500 ft, 6 June 1982, T. & R. Griswold. Emery Co.: 1 female, 4 air mi N Gilson Butte, 5100 ft, 12–14 Sep 1983, Parkers & Griswold; 1 female, same except 16–17 Sep 1980, T. Griswold; 3 females, 12 mi N Hanksville, Emery County line, 22–23 Aug 1979, F. D. Parker; 2 females, ½ air mi NE Little Gilson Butte, 5050 ft, 12 Sep 1983, Parkers & T. Griswold; 10 females, 3 males, 2 air mi E Little Gilson Butte, 5100 ft, 24–26 Aug 1981, Veirs, Parker, Griswold; 1 female, same except 15–17 Sep 1980; 18 females, 8 males, same except Parker; 6 females, 1 male, same except Veirs; 7 females, same except Griswold; 1 female, 3.2 air mi NE Little Gilson Butte, 5000 ft, 23 July 1981, Veirs, Griswold, Parker; 1 female, same except 28 May 1985, D.K. Broemeling; 1 female, Wild Horse Creek, N Goblin Valley, 4900 ft, 21–23 July 1981, Veirs, Griswold, Parker; 1 male, same except 25–28 July 1983, Parkers & Griswold; 1 male, Goblin Valley, sand dunes, 16 Sep 1979, F.D. Parker, D. F. Veirs; 1 male, San Rafael Desert, near Little Gilson Butte, 5000–5100 ft, 19 and 24–27 Aug 1980, A.S. & K. Menke, F.D. Parker; 3 males, ½ mi E Little Gilson Butte, 16 Aug 1992, T. Griswold. Holotype in the Logan collection, paratypes in Logan, Lawrence, Berkeley, Davis, Washington, and New York.

Distribution.—Known only from the San Rafael Desert section of the Colorado Plateau.

Discussion.—*Neolarra (Phileremulus) ute* is closely related to *N. alexanderi*, and can be distinguished from all other species of *Phileremulus* except *N. alexanderi* by the characters given in the discussion of the latter. It can be separated from *N. alexanderi* by the long mouthparts and larger size. Females also differ by the slightly incurved apical margin of T5.

LITERATURE CITED

- Hurd, P. D., Jr. & E. G. Linsley. 1951. The melectine bees of California. *Bulletin California Insect Survey* 1: 119–140.
- Linsley, E. G. 1939. A revision of the nearctic Melectinae. *Annals of the Entomological Society of America* 32: 429–468.
- Shanks, S. S. 1978. A revision of the cleptoparasitic bee genus *Neolarra*. *Wasmann Journal of Biology* 35: 212–246.

Two New Genera of Pemphredonine Wasps from Australia (Hymenoptera: Apoidea, Crabronidae)

By

GABRIEL A. R. MELO¹ AND IAN NAUMANN²

ABSTRACT Three new species from Australia belonging to two new genera of pemphredonine wasps are described and illustrated. The new genera belong in the subtribe Stigmina of the tribe Pemphredonini. *Allostigmus*, gen. n., is found in mainland Australia (Victoria and Northern Territory) and two new species are assigned to it, *A. alexanderi*, sp. n. and *A. provisorius*, sp. n. *Ceratostigmus*, gen. n., contains one species, *C. tasmanicus*, sp. n., and is known only from Tasmania. The putative affinities of these two genera to *Paracrabro* Turner, the only genus of Stigmina previously known from Australia, are discussed.

Keywords: Apoidea; Sphecidae; Pemphredoninae; New genera; Australia; Tasmania; Morphology.

INTRODUCTION

Four genera of Pemphredonini are currently known from Australia: *Polemistus*, *Paracrabro*, *Spilomena* and *Arpactophilus* (Bohart & Menke, 1976). During our studies of the pemphredonine wasps from Australia, we found material of three new species here described in two new genera within the subtribe Stigmina. *Paracrabro*, with one described and one undescribed species, is the only genus of Stigmina hitherto known from Australia. Nothing is known about the biology of these Stigmina, including the new species described here. The position of the two new genera proposed here will be more fully discussed in a separate paper by the first author on the phylogenetic relationships among the genera of the tribe Pemphredonini.

The subtribe Stigmina was recently characterized by Finnamore (1995), who also provided an identification key for the genera. The following key can be used to identify the three Australian genera of Stigmina.

1. Lower frons weakly concave in the middle, without scapal basins and medial protuberance. Inner orbits not margined by paraocular sulcus. Labrum with medial and lateral apical lobes. Acetabular carina evanescent, not continuous with omaular carina. Metasomal petiole as long as wide in dorsal view. Disc of metasomal terga I and II glabrous. Tasmania. *Ceratostigmus*, gen. n.
- Lower frons with well-developed scapal basins and medial protuberance. Inner orbit margined by a paraocular sulcus. Labrum rounded apically or only

slightly emarginate in the middle. Acetabular carina strong, continuous with omaular carina. Metasomal petiole at least 1.5× as long as wide. Disc of terga I and II densely setose. Mainland Australia. 2

2. Female mandible bidentate. Pronotal lobe acarinate. Vertex declivitous immediately behind ocelli. Metasomal petiole transversely carinate. Female hind tibia not expanded. *Allostigmus*, gen. n.
- Female mandible with at least three apical teeth. Pronotal lobe with a conspicuous dorsal carina. Vertex produced behind ocelli. Petiole without transverse carinae. Female hind tibia expanded.
..... *Paracrabro* Turner

The morphological terms used here are mostly from Bohart and Menke (1976), except as follows: terminology of surface sculpturing is from Harris (1979); mandibular morphology, from Michener and Fraser (1978); the terms "micropore field" and "keitrichia" are from Finnamore (1995) and Michener (1981), respectively. The terms alveolus and alveolar refer to the antennal sockets. The omaular carina corresponds to the "omaulus" of Bohart and Menke (1976), whereas omaulus is used here to designate the area of the mesepisternum where its anterior and lateral surfaces meet. The surface of release of the secretions from the facial gland is called a micropore field; the term "facial fovea" (Schubert and Schönitzer, 1993) is avoided because not all species with a facial gland have a facial fovea; the Stigmina have an additional micropore field on the upper frons and vertex (Finnamore, 1995), here termed "secondary micropore field."

¹ Snow Entomological Collection, Museum of Natural History, University of Kansas, Lawrence, KS 66045. Present address: Departamento de Biologia, FFCLRP, Universidade de São Paulo, Av. Bandeirantes 3900, 14040-901, Ribeirão Preto, SP, BRAZIL. E-mail: garmelo@ffclrp.usp.br

² Division of Entomology, CSIRO, P. O. Box 1700, Canberra, ACT 2601, AUSTRALIA.

The information provided between quotation marks in the Type Material sections is a transcription of data from the specimen labels; abbreviated information is completed in brackets. Type depositories and their acronyms are as follows: American Entomological Institute, Gainesville, Florida, U.S.A. (AEI); Australian National Insect Collection, Canberra, Australia (ANIC).

ACKNOWLEDGMENTS

This paper is dedicated to the memory of Byron A. Alexander, friend, colleague and mentor. We thank C. D. Michener for his suggestions on the manuscript. This work was supported by a grant from the "Conselho Nacional de Desenvolvimento Científico e Tecnológico" (Brazil) to the first author (200233/92).

Allostigmus, gen. n.

DESCRIPTION

Labrum flat, its apical margin rounded, entire; mandible bidentate; clypeus covered by dense, silvery pubescence; scapal basin well developed in female, frontal tubercle present; orbits margined by a paraocular sulcus; micropore field of facial gland small, situated in an elongate fovea; secondary micropore field elongate, micropores longitudinally distributed over upper frons and vertex; vertex declivitous immediately behind ocelli, ocelli situated at highest point of vertex; gena relatively narrow, half width of eye in lateral view; occipital carina complete; pronotal lobes without carina, uniformly covered by short pubescence; acetabular carina present, continuous with omaular carina; episternal sulcus, anterior to acetabular carina, weakly indicated; wings covered with dense pubescence, setae as long as or longer than width of distal veins; pterostigma completely covered by setae, micropore field not differentiated; male midtibial spur absent, midbasitarsus modified; hindtibia unmodified, not swollen; metasomal petiole transversely carinate; terga I and II covered with dense, short pubescence; pygidial plate broad in female, absent in male; male sterna without specialized integument; apical projection of sternum VIII very long, its apex with numerous, sensilla-like structures; male genitalia, including gonobase, narrow and very elongate, foramen of gonobase situated away from bases of gonocoxites and directed anteriorly.

Type-species.—*Allostigmus alexanderi*, sp. n.

Etymology.—From the Greek *allos*, other + *Stigmus*, the type genus of the subtribe Stigmina.

Diagnosis and comments.—This genus can be distinguished from other Stigmina by the following combination of traits: bidentate mandible, clypeus with dense, silvery pubescence, narrow gena, acetabular carina present, pterostigma without differentiated micropore field, male

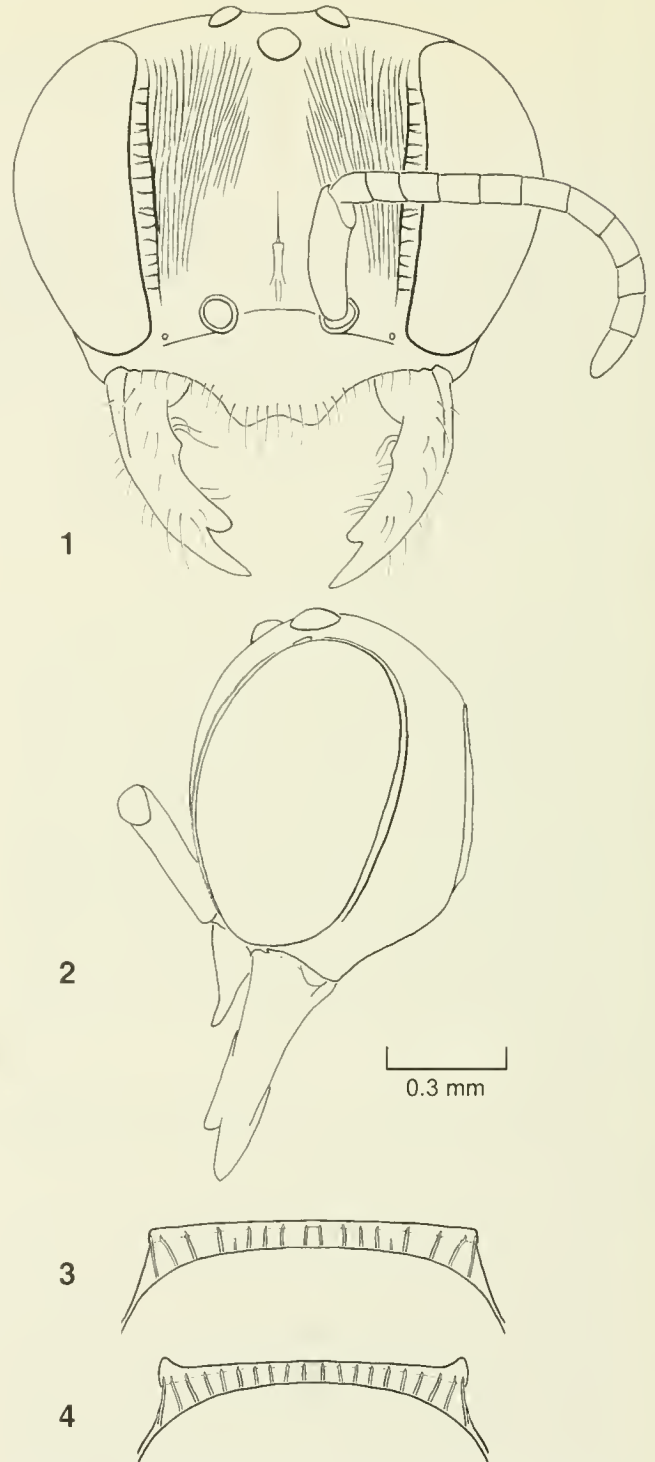

Figs. 1–4. *Allostigmus alexanderi*, sp. n., female. 1—Head, frontal view. 2—Same, lateral view. 3—Pronotal collar, posterodorsal view. *Allostigmus provisorius*, sp. n., male. 4—Pronotal collar, posterodorsal view.

midtibial spur absent, male midbasitarsus modified, hindtibia unmodified, transversely carinate metasomal petiole, and broad pygidial plate in female. *Allostigmus*

seems to be most closely related to *Paracrabro*. Both have a labrum with an unnotched apical margin, a well developed scapal basin and frontal protuberance, eyes margined by a paraocular sulcus, and acetabular carina continuous with omaular carina. *Allostigmus*, *Ceratostigmus* and *Paracrabro* seem to form a monophyletic group within the Stigmata (Melo, unpubl.); however, the only known synapomorphy uniting them is the presence of an acetabular carina. *Allostigmus* and *Ceratostigmus* also have the male sternum VIII with sensilla-like structures on its apex and modified male genitalia (Melo, unpubl.). *Ceratostigmus* and *Paracrabro* have in common an expanded female hindtibia (more accentuated in *Paracrabro*).

Finnamore (1995) described, as a male of *Paracrabro froggratti*, a specimen that we think represents an additional species of *Allostigmus*. His male specimen differed from the female of *P. froggratti* in the sculpture of the lateral portion of the mesepisternum (carinae weaker and scrobal sulcus absent in female), in the number of hindtibial bristles and in the pubescence of forewing. This male has a modified midbasitarsus, as in *A. provisorius*. Until males of *Paracrabro* are known, it will remain impossible to produce a diagnosis for *Allostigmus* based on male features.

Allostigmus alexanderi, sp. n.

(Figs. 1–3)

DESCRIPTION

Female.—Body length: 5 mm; forewing length: 3.7 mm.

Color: Integument predominantly black; following structures reddish yellow: palpi, labrum, mandibles except teeth reddish brown, antennae, pronotal lobes, tegulae and bases of wings, legs (except for brown fore and midcoxae) and metasomal petiole; wing veins light brown, membrane hyaline, pterostigma brown with an elongate, dark spot.

Pubescence: Outer surface of mandible with three rows of long (120–230 μm), yellow setae, longer along condylar groove, base with sparse, short setae; inner surface with row of setae parallel to inner edge, longer at base and apical third. Compound eye with sparse, short setae, longer on lower half. On clypeus, setae appressed, dense, and silvery; disc with a few semi-erect setae, those along apical edge of silvery pubescence surpassing clypeal apex by 60–100 μm ; apical margin of medial lobes glabrous. Lower paraocular areas as clypeus; scapal basin and upper medial area of frons glabrous; on remainder of frons and vertex lateral to ocelli, setae very sparse, fine and short. On vertex behind ocelli, and on gena, dense, fine and short, longer on lower gena; area around hypostoma almost glabrous. On most of meso- and metasoma, dense, fine and

short. On mesoscutum and scutellum, very sparse, except over anterior one-third and posterior margin of mesoscutum and posterior corners of scutellum. Mesepisternum between omaular sulcus and hypersternaulus with silvery pubescence; on area below hypersternaulus, sparse anteriorly; ventral surface with small, glabrous area on each side, immediately behind acetabular carina. Foretibia, along apical third of anterior surface, with several erect, thick setae. Mid and hindtibiae with relatively long bristles (40–90 μm long on mid and 60–120 μm long on hindtibia). Anterior and outer surfaces of midtibia with two bristles each, posterior surface with three and apex with five. Outer surface of hindtibia with one long bristle, posterior surface with two, and apex with two short ones; posterior surface almost glabrous; inner surface with keirotichia forming a narrow band posteriorly (40–50 μm wide), apically with a rectangular area (65 \times 125 μm) covered with shorter and denser keirotichia. Wings with short, brown pubescence, setae slightly longer than width of distal veins; pterostigma covered completely with dense, short setae; apical margin fringed. Dorsal and lateral surfaces of propodeum glabrous, except for narrow area dividing these two surfaces. Lateral surface and marginal zone of T1 glabrous. Marginal zone of T3–4 with sparse, erect setae among decumbent pubescence. T5 marginal zone without decumbent pubescence, erect setae more numerous and longer. T6 with sparse, erect pubescence; pygidial plate glabrous, lateral setae slightly longer than maximum width of plate. Apex of gonostylus with tuft of erect, laterally directed setae, longest ones slightly longer than width of gonostylus in ventral view.

Integumental surface: Predominantly shiny. Clypeus smooth except for setigerous punctures, most of surface hidden by pubescence; exposed area of apical lobes finely and weakly coriarius. Eyes margined by well-developed sulcus delimited by strong carina, sulcus wider along inner orbits, interrupted dorsally by fovea of facial gland. Lower frons mostly smooth except for setigerous punctures; scapal basin and medial portion of upper frons finely coriarius; remainder of frons and lower gena conspicuously strigate (Fig. 1). Micropore field of facial gland in elongate, narrow paraocular fovea; secondary micropore field on vertex well developed but inconspicuous because of strigation. Hypostomal carina joining apical inflection of clypeus and not mandibular sockets. Occipital carina complete, stronger ventrally. Transverse carina of pronotum well developed, lateral corners not raised in relation to rest of carina (Fig. 3), continuing laterally toward anterior margin of pronotum as weaker carina; collar and lower, lateral portion of pronotum carinate; pronotal lobe without carina. Notaulus a short sulcus, deeper anteriorly; anterior one-third of mesoscutum densely punctured, also

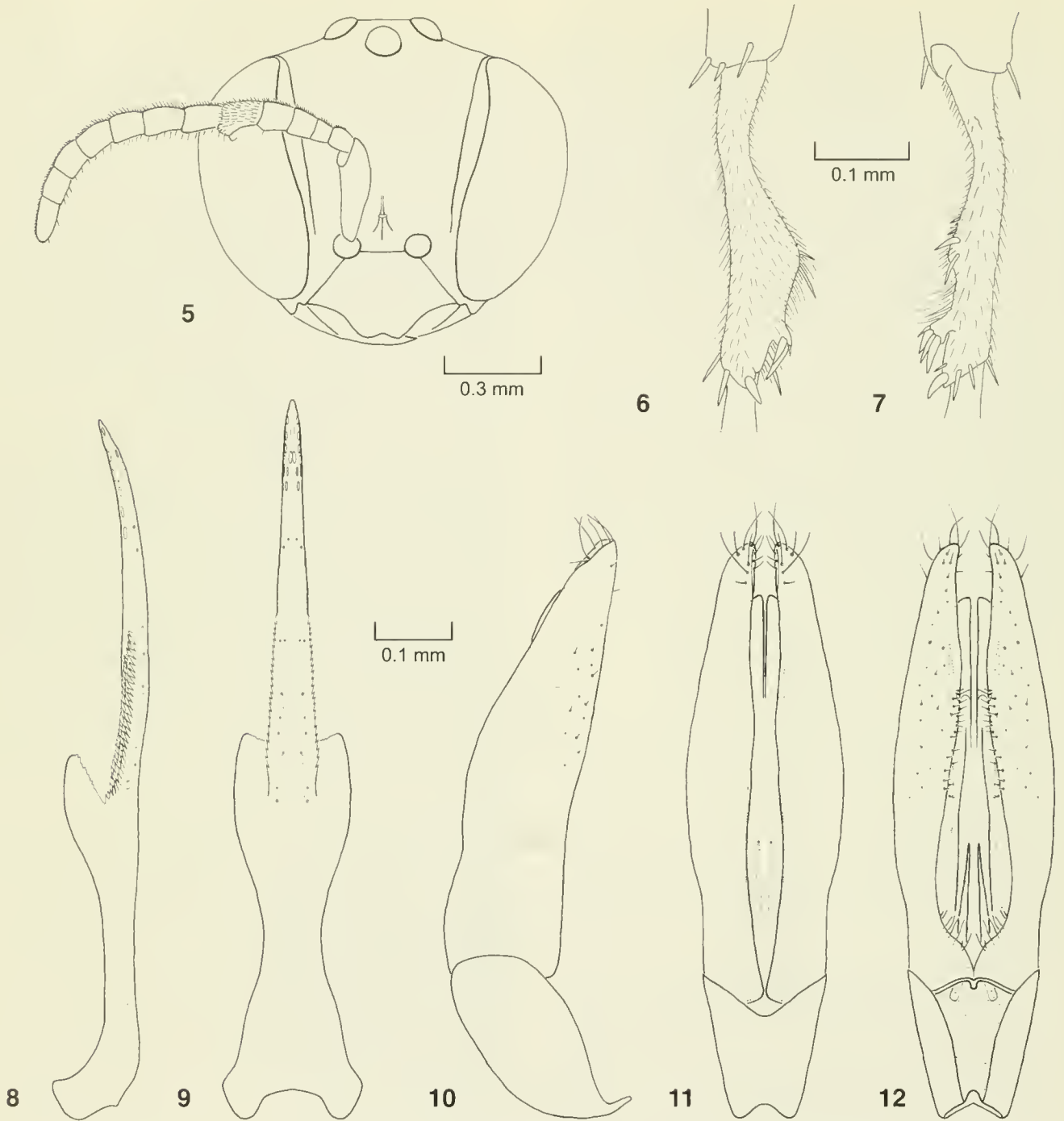

Figs. 5-12. *Allostigmus provisorius*, sp. n., male. 5-Head, frontal view (complete flagellar pubescence illustrated only for one flagellomere). 6-Midbasitarsus, inner view. 7-Same, posterior view. 8-Sternum VIII, lateral view. 9-Same, ventral view. 10-Genitalia, lateral view. 11-Same, dorsal view. 12-Same, ventral view.

weakly rugose medially and imbricate laterally (denser punctation extending farther posteriorly on areas behind notauli and admedian lines); posterior two-thirds sparsely punctured, punctures with different diameters and separated by 3 to 7 puncture diameters; posterior margin with

short, longitudinal carinae. Disc of scutellum sparsely punctured, punctures separated by 3 to 5 diameters; posterior margin weakly rugose. Metanotum weakly rugose, carinae oriented longitudinally. Omaular carina well defined, continuous with acetabular carina ventrally; ven-

tral portion of episternal sulcus evanescent, portion distal to acetabular carina stronger and continuous with well-developed hypersternaulus; upper portion of mesepisternum (dorsal to hypersternaulus) rugulose, scrobal sulcus well developed, crossed by several carinae; portion ventral to hypersternaulus costate; ventral portion densely and finely punctured except for two small, smooth areas anteriorly. Lateral portion of metepisternum conspicuously coriarius. Dorsal and lateral surfaces of metasomal petiole transversely carinate; remainder of metasoma smooth and shining, except for fine, dense punctures.

Structure: (measurements in mm) Head wider than long (1.39 : 1.09), inner orbits subparallel (upper to lower interorbital distance, 0.72 : 0.67). Eye 1.6× longer than its maximum width (0.81 : 0.51); gena relatively narrow, half width of eye in lateral view (0.23 : 0.46, measured at middle of eye). Malar space very narrow, eye almost in contact with mandibular base. Palpi relatively long, maxillary palpus slightly surpassing occipital carina ventrally. Labrum flat, wider than long (0.26 : 0.17), apex simple, uniformly rounded. Mandibles bidentate, apical tooth 5× longer than dorsal subapical one (0.16 : 0.03); inner edge (frontal view) with tooth-like angle approximately halfway between mandibular base and apex of subapical tooth. Clypeus weakly convex, 2.6× broader than long (0.75 : 0.29); apex medially strongly projected, slightly upturned and bilobed, lobes rounded. Epistomal suture, between antennal alveoli, straight; tentorial pit closer to orbit than to alveolar rim (0.05 : 0.10). Inter-alveolar distance nearly 3× alveolar diameter (0.23 : 0.08); alveolo-orbital distance 1.5× alveolar diameter (0.12 : 0.08). Scape 4.5× as long as maximum width (0.45 : 0.10), longer than half alveolo-ocellar distance (0.45 : 0.67); pedicel 1.5× longer than its maximum width (0.12 : 0.08); 1st flagellomere nearly quadrate in profile (length:width, 0.08 : 0.07), 2nd 1.25× longer than wide (0.10 : 0.08); 3rd to 7th subequal in dimensions, 1.5× longer than wide (0.12 : 0.08); 8th and 9th as 2nd; apical flagellomere 2× longer than its maximum width (0.15 : 0.07). Frons strongly depressed medially, forming well-developed scapal basins; supra-clypeal area with strong, blunt frontal spine. Vertex, in frontal view, only slightly projected above compound eyes, ocelli at highest point of vertex; anterior and posterior ocelli separated by nearly 0.75 of anterior ocellar diameter (0.08 : 0.11), distance between posterior ocelli equal to 1.6× their diameter (0.19 : 0.12); ocello-orbital distance equal to distance between posterior ocelli (0.19 : 0.19). Transverse pronotal carina separated from mesoscutum by 0.4× diameter of posterior ocelli (0.05 : 0.12) medially and by nearly 1.2 (0.14 : 0.12) at lateral angles. Mesoscutum 1.3× wider (width between tegulae) than long (0.96 : 0.73). Foretrochanter 2.4× longer than its maximum width (0.29 : 0.12). Midtibial spur very slender, its length

equal to 0.6 of basitarsal length (0.21 : 0.36). Hindtibia 4.7× longer than its maximum width (0.75 : 0.16); spurs subequal in length (outer:inner spur, 0.21 : 0.24), outer spur very slender. In hindwing, media diverging before cu-a. Metasomal petiole, in dorsal view, 2.3× longer than wide (0.37 : 0.16). Pygidial plate relatively broad, 1.6× longer than its maximum width (0.21 : 0.13), its apex not surpassing posterior tergal margin.

Type material.—Holotype female, "Moeroopna, Vic.[toria], 3. 1. 1939, A. D. Butcher." (ANIC).

Etymology.—This species is named in memory of Byron A. Alexander.

Diagnosis and comments.—*Allotigmus alexanderi* and *A. provisorius* are known from only one specimen each. Since they are of different sexes and have many features in common, they could be considered as conspecific. The only significant, non-sexual difference between them is the shape of the transverse pronotal carina: in *A. alexanderi* the lateral corners are at the same level as the central portion of the carina (Fig. 3), while in *A. provisorius* the lateral corners are protuberant (Fig. 4). However, the two specimens come from widely separated and distinct regions of Australia, and for the moment we prefer to treat them as distinct species. Additional material might help resolve the status of these two putative species.

Allotigmus provisorius, sp. n.

(Figs. 4–12)

DESCRIPTION

Male.—Body length: 4.5 mm; forewing length: 3.0 mm. Agreeing with female of *Allotigmus alexanderi* in color, pubescence and integumental surface, except long setae on mandibles less numerous, silvery pubescence on clypeus and frons denser, covering whole clypeus and two-thirds of frontal paraocular area, flagellomeres with short but conspicuous, erect setae, apico-ventral protuberance on 4th flagellomere with a distinct curved seta (Fig. 5), ventral surface of mesepisternum without glabrous areas anteriorly, bristles on midtibia restricted to apex, microsculpture on scapal basin and upper medial frons more prominent, micropore fields on vertex rudimentary, hypostomal carina joining mandibular sockets, lateral corners of transverse pronotal carina protuberant, conspicuously raised in relation to rest of carina (Fig. 4). Structural differences from female of *A. alexanderi* (measurements in mm): inner orbits converging below (upper to lower interorbital distance, 0.66 : 0.48); lower, frontal facets of compound eyes distinctly enlarged; clypeus almost 1.8× broader than long (0.75 : 0.29), with less developed apical lobes; interalveolar distance nearly 1.8× alveolar diameter (0.14 : 0.08); alveolo-orbital distance slightly shorter than diameter of alveolus (0.07 : 0.08); length of scape 3.2× its

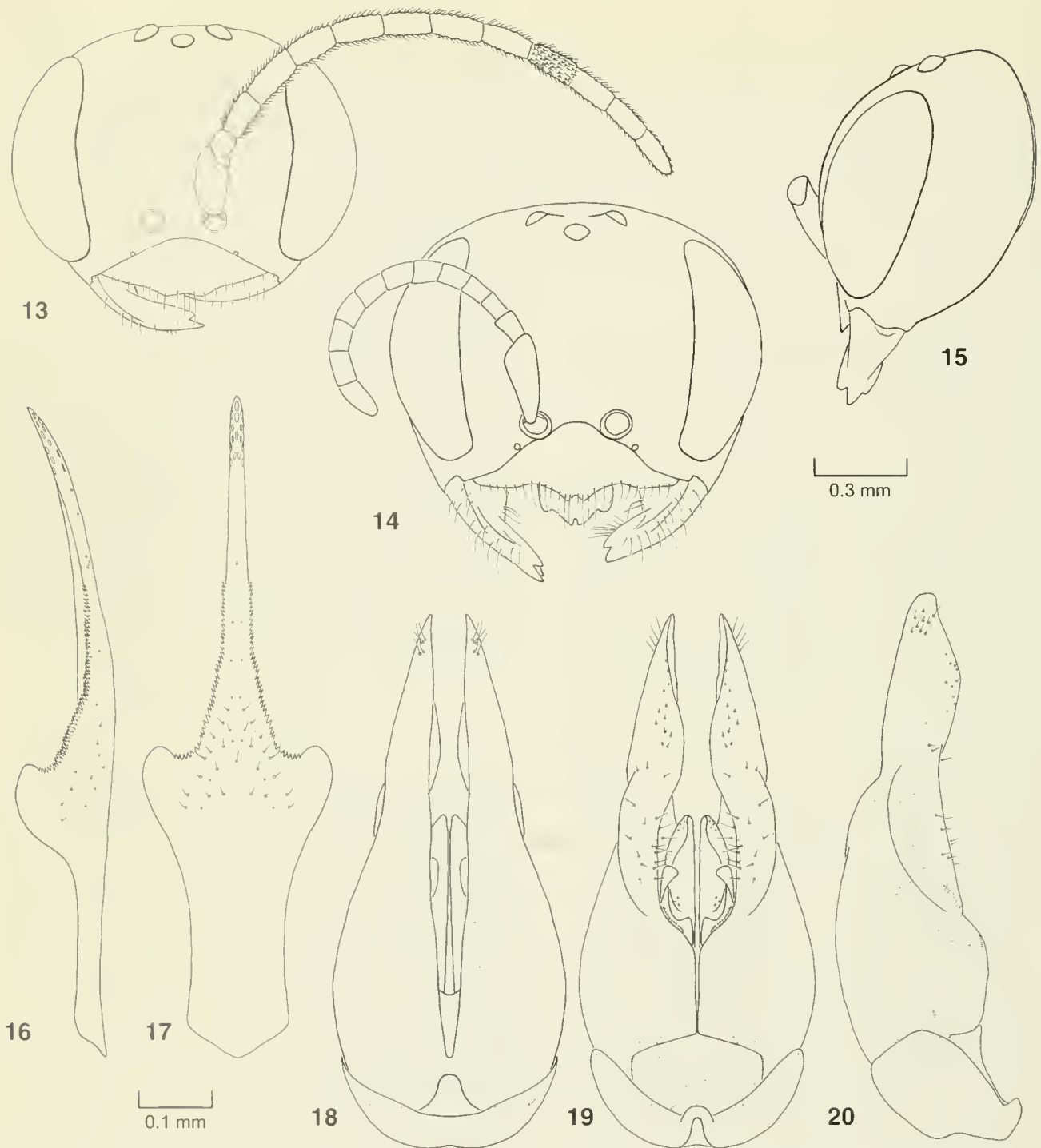

Figs. 13-20. *Ceratostigmus tasmanicus*, sp. n. 13-Male head, frontal view (complete flagellar pubescence illustrated only for one flagellomere). 14-Female head, frontal view. 15-Same, lateral view. 16-Male sternum VIII, lateral view. 17-Same, ventral view. 18-Male genitalia, dorsal view. 19-Same, ventral view. 20-Same, lateral view.

maximum width (0.35 : 0.11); pedicel nearly as wide as long (0.07 : 0.08); 1st flagellomere wider than long (0.07 : 0.06), 2nd subquadrate in profile (length:width, 0.08 : 0.07), 3rd nearly 1.3× longer than wide (0.10 : 0.08), 4th distinctly

shaped, with an apico-ventral protuberance (Fig. 5), 1.5× longer than wide (0.12 : 0.08); scapal basin shallow, separated from paraocular area by weak carina; anterior and posterior ocelli separated by 0.6 of anterior ocellar diam-

eter (0.11 : 0.07), distance between posterior ocelli equal to 1.4× their diameter (0.17 : 0.12), ocello-orbital distance shorter than distance between posterior ocelli (0.14 : 0.17); midtibial spur absent, basitarsus curved, flattened and expanded posteriorly, with subapical projection (apex of projection with thick, peg-like bristles) and an apical peg-like bristle (Figs. 6 and 7); apex of tergum VII pointed, without pygidial plate. Sterna IV and V without basal band of specialized, strongly colliculate integument. Sternum VIII and genitalia as in Figs. 8, 9 and 10–12, respectively.

Type material.—Holotype male, "Areyonga, 600m, N.[orthern] T.[erritory], Australia, September 15". (AEI).

Etymology.—This species is named in reference to its uncertain status regarding the possibility that it could represent the male of *Allostigmus alexanderi* sp. n.

Diagnosis and comments.—See *Diagnosis and comments* for *Allostigmus alexanderi*.

Ceratostigmus, gen. n.

DESCRIPTION

Labrum flat, its apical margin notched in the middle and laterally; mandibles tridentate; female clypeus with sparse pubescence, in male, dense and silvery; scapal basin and frontal tubercle absent; orbits not margined by a paraocular sulcus; male flagellum very long, covered with dense, erect pubescence; micropore field of facial gland small, at same level as adjacent surfaces; secondary micropore field short and narrow, micropores longitudinally distributed over upper frons; vertex produced behind ocelli; gena broad, in female as wide as width of eye in lateral view; occipital carina interrupted ventrally; pronotal lobe without carina, uniformly covered by short pubescence; acetabular carina present, not continuous with omalar carina; wings densely setose, setae as long as or longer than width of distal veins; pterostigma completely covered by setae, differentiated micropore field absent; male midbasitarsus unmodified; female hindtibia slightly expanded, outer surface flattened posteriorly; disc of terga I and II glabrous; pygidial plate vestigial in female, absent in male; male sterna without specialized integument; apical projection on sternum VIII very long, its apex with numerous, sensilla-like structures; male genitalia elongate, foramen of gonobase situated away from base of gonocoxites and directed anteriorly.

Type-species.—*Ceratostigmus tasmanicus*, sp. n.

Etymology.—This genus is named in reference to the elongate antennae of the male, from the Greek *keratos*, horn + *Stigmus*, the type genus of the subtribe Stigmina.

Diagnosis and comments.—This genus can be distinguished from other Stigmina by the following combination of traits: notched apical margin of labrum, tridentate

mandibles, male flagellum very long, ventrally interrupted occipital carina, acetabular carina present, pterostigma without differentiated micropore field, female hindtibia expanded, and female pygidial plate vestigial. The affinities of *Ceratostigmus* to other Stigmina are discussed above under *Diagnosis and comments* for *Allostigmus*. The type species is known only from Tasmania. It is possible that additional species occur in mainland Australia.

Ceratostigmus tasmanicus, sp. n.

(Figs. 13–20)

DESCRIPTION

Female.—Body length: 4.3 mm; forewing length: 3.1 mm.

Color: Integument predominantly black; palpi, tibiae and tarsi reddish yellow; pronotal lobes white; anterior veins on forewing and pterostigma dark brown, posterior veins light brown, membrane hyaline.

Pubescence: Mandible and apical margin of clypeus with long (100–190 μm), reddish brown setae, longer on medial clypeal lobes; on remainder of clypeus, setae very sparse, erect on disc and mostly decumbent laterally. Lower paraocular area as adjacent area of clypeus; remainder of frons, except for glabrous medial supraclypeal area, with short (15–35 μm), erect setae, shorter toward vertex. On gena, short and very sparse, longer ventrally. On compound eyes, very short, inconspicuous. On most of mesosoma, dense, fine and short; sparse on lateral portion of mesepisternum. Tibial bristles short (30–35 μm). Wings with short, dense, brown pubescence, setae slightly longer than width of distal veins; pterostigma uniformly covered with dense, short setae; apical margin fringed. Dorsal and lateral surfaces of propodeum glabrous. Terga I and II mostly glabrous, except on dorsal surface of petiole and lateral portion of T2; on exposed surfaces of T3–5, short and relatively dense, sparser and longer on marginal zones; apex of T6 with long (120–170 μm), erect, sparse, reddish brown setae.

Integumental surface: Most of head and thorax strongly coriaceous and dull, on upper frons and mesoscutal disc almost colliculate; clypeus, upper frons, vertex, mesoscutum and scutellum also with strong punctures, more conspicuous on mesoscutum and scutellum. Micropore field of facial gland indicated as narrow (maximum width 25 μm) paraocular strip of microreticulate integument on vertex; secondary micropore field on upper frons narrow and inconspicuous because of sculpturing. Occipital carina interrupted ventrally. Transverse pronotal carina relatively weak and closely appressed to mesoscutum; collar laterally and lateral surface of pronotum carinate. Anterior surface of mesoscutum

weakly rugose-imbricate; notauli marked as short sulci crossed by very short, weak carinae. Omaular and acetabular carinae relatively weak, not continuous with one another (interrupted by ventral portion of episternal sulcus); hypersternaulus well developed, crossed by short carinae and continuous with episternal sulcus; scrobal sulcus very weakly indicated; lower portion of mesepisternum (ventral to hypersternaulus) and lateral portion of metepisternum weakly coriarius. Dorsal and lateral surface of metasomal petiole separated by weak, sinuous carina; ventral surface of petiole with a few, short, longitudinal carinae; terga weakly coriarius, shiny; T6 with conspicuous punctures.

Structure: (measurements in mm) Head cuboidal, rounded in frontal view, wider than long (1.21 : 0.91); inner orbits subparallel (upper to lower interorbital distance, 0.72 : 0.68) (Fig. 14). Eye almost twice as long as its maximum width (0.74 : 0.38); gena broad, as wide as eye in lateral view (0.35 : 0.35, measured at middle of eye). Malar space narrow, one-fourth width of mandibular base (0.05 : 0.21). Palpi relatively long, maxillary palpi slightly surpassing occipital carina ventrally. Labrum flat, wider than long (0.21 : 0.14), apex notched medially and laterally, delimiting two lateral lobes (labral features and measurements from a paratype). Mandibles tridentate, with dorsal and ventral subapical teeth; inner edge (frontal view) without tooth-like angles. Clypeus weakly convex, nearly 2.8× broader than long (0.66 : 0.24); apex produced in middle, with a medial, triangular notch, lobes bluntly pointed. Tentorial pit much closer to antennal alveolar rim than to orbit (0.05 : 0.14). Inter-alveolar distance slightly longer than alveolar diameter (0.12 : 0.10); alveolo-orbital distance 1.6× diameter of alveolus (0.16 : 0.10). Scape short, nearly 3× longer than its maximum width (0.35 : 0.12), slightly longer than half alveolo-ocellar distance (0.35 : 0.62); pedicel and flagellomeres 1–9 subequal in size, approximately 1.5× longer than their maximum widths (0.12 : 0.08); apical flagellomere 2× longer than its maximum width (0.15 : 0.07). Lower frons weakly concave medially, not forming a scapal basin. Anterior and posterior ocelli separated by slightly more than one anterior ocellar diameter (0.10 : 0.08), distance between posterior ocelli 2.4× their diameter (0.19 : 0.08); ocello-orbital distance slightly longer than distance between posterior ocelli (0.21 : 0.19). Mesoscutum 1.3× wider (width between tegulae) than long (0.91 : 0.70). Foretrochanter nearly 2× longer than its maximum width (0.25 : 0.13). Midtibial spur slender, its length almost half basitarsal length (0.16 : 0.35). Hindtibia slightly but conspicuously expanded, 3.7× longer than its maximum width (0.70 : 0.19), outer surface flattened posteriorly; inner spur 1.4× longer than outer spur (0.22 : 0.16). Media in hindwing diverging from CuA before cu-a.

Metasomal petiole very short, as long as wide in dorsal view (0.15 : 0.15). Pygidial plate vestigial, very narrow and tear-shaped, 3.3× longer than its maximum width (0.10 : 0.03), its apex slightly extending beyond posterior tergal margin.

Male.—Body length: 4.1 mm; forewing length: 2.8 mm. Agreeing with female in color, pubescence and integumental surface, except as follows: pale yellow palpi, mandible except teeth reddish brown, and scape except for large, apical brown spot; anterior half of tegula white, remainder light brown; legs reddish yellow except for coxae and large spots on inner surface of fore- and midfemora and most of hindfemur brown; clypeus, malar space and lower two-thirds of frons covered with dense, silvery pubescence; flagellum with conspicuous, short (30–35 μm) and erect pubescence (Fig. 13), its surface granulate, each setae arising from small protuberance; micropore fields on vertex very reduced, inconspicuous; tibiae without bristles except for short, apical ones. Structural differences from female (measurements in mm): head less cuboidal, gena narrower than eye in lateral view (0.23 : 0.33, measured at middle of eye); lower, frontal facets of compound eyes enlarged, but only slightly; mandible bidentate; medial emargination of clypeal apex shallow, apical lobes short and rounded; antennal alveolus not in contact with epistomal suture; scape swollen, approximately 2× longer than its maximum width (0.27 : 0.13); pedicel short, quadrate in profile (length:width, 0.08 : 0.08); flagellum very long, 1st flagellomere nearly 1.8× longer than its maximum width (0.14 : 0.08), 2nd 2× longer than wide (0.16 : 0.08), flagellomeres 3–10 gradually decreasing in length and width, apical flagellomere 2.7× longer than its maximum width (0.19 : 0.07); anterior and posterior ocelli separated by one anterior ocellar diameter (0.08 : 0.08); hindtibia not swollen, 5.8× longer than its maximum width (0.64 : 0.11); terga III–VI with overhanging graduli; apex of tergum VII pointed, without pygidial plate. Sterna IV and V without basal band of specialized, strongly colliculate integument. Sternum VIII and genitalia as in Figs. 16, 17 and 18–20, respectively.

Type material.—Holotype female, “42.15S 146.29E, 14 km S TAS[mania], Bronte Park, 15 Jan[uary]–3 Feb[ruary] 1983, I. D. Naumann & J. C. Cardale, Malaise/ethanol” (ANIC). Paratypes: 1 female, “Australia, Tas.[mania], Mt. Field N.[ational] P[ark], Jan.[uary] 8–14, 1984, L. Masner, M[alaise] T[rap]”; 1 female, “Mount Barrow, Tasmania, 700 m., February”; 1 female, “Bronte Park, Tasmania, January 2–8”; 1 male, “Strahan, Tasmania, Mar.[ch] 14–26” (all paratypes in AEI).

Etymology.—This species is named after the island of its origin, Tasmania.

Diagnosis and comments.—For diagnosis, see *Diag-*

nosis and comments for the genus *Ceratostigmus*. The three female paratypes are slightly smaller than the female holotype; also, in two of them, the mandibles, except for brown base and reddish teeth, are light brown.

LITERATURE CITED

- Bohart, R. M. and A. S. Menke. 1976. *Sphecid Wasps of the World*. Berkeley, University of California Press. ix+695 pp.
- Finnamore, A. T. 1995. Revision of the world genera of the subtribe Stigmia (Hymenoptera: Apoidea: Sphecidae: Pemphredoninae), Part 1. *Journal of Hymenoptera Research* 4: 204-284.
- Harris, R. A. 1979. A glossary of surface sculpturing. *Occasional Papers of Laboratory Services/Entomology of the California Department of Agriculture* 28: 1-31.
- Michener, C. D. 1981. Classification of the bee family Melittidae with a review of species of Meganomiinae. *Contributions of the American Entomological Institute* 18(3): 1-135.
- Michener, C. D. and A. Fraser. 1978. A comparative anatomical study of mandibular structure in bees. *University of Kansas Science Bulletin* 51: 463-482.
- Schuberth, J. and K. Schönitzer. 1993. Vergleichende Morphologie der Fovea facialis und der Stirnseitendrüse bei Apoidea und Sphecidae (Hymenoptera, Aculeata). *Linzer Biologische Beiträge* 25: 205-277.

Reassessment of the Bee Genus *Chaeturginus* (Apoidea: Andrenidae, Panurginae), with the Description of a New Species From Southeastern Brazil

By

LUISA RUZ¹ AND GABRIEL A. R. MELO²

ABSTRACT We describe and illustrate a new species of *Chaeturginus* Oliveira and Moure, a genus hitherto known to contain only one species. We also re-evaluate the generic characters of *Chaeturginus* and designate a lectotype for *Rhophitulus testaceus* Ducke.

Keywords: Apoidea; Andrenidae; Panurgini; *Chaeturginus*; Solitary bee; Neotropical region.

INTRODUCTION

The genus *Chaeturginus* was erected by Oliveira and Moure (1963) to accommodate an unusual species described by Ducke (1907) in the genus *Rhophitulus*. This species is known only from two localities in the Amazon basin, in Brazil. *Chaeturginus* has remained monotypic since its proposal, but specimens of an undescribed species from southeastern Brazil (Minas Gerais and São Paulo states) were found recently. In the present paper, together with the description of this new species, we re-evaluate the generic characters of *Chaeturginus*, based on the work of Ruz (1986), and designate a lectotype for *Rhophitulus testaceus* Ducke.

ACKNOWLEDGMENTS

We would like to thank C. D. Michener for suggestions to the manuscript, and J. G. Rozen Jr. (American Museum of Natural History, New York), F. A. Silveira (Universidade Federal de Minas Gerais, Belo Horizonte) and F. Koch (Museum für Naturkunde, Berlin) for making specimens available for study. Financial aid was provided to LR by the "Dirección General de Investigación, Universidad Católica de Valparaíso", Chile, and to GARM by the "Conselho Nacional de Desenvolvimento Científico e Tecnológico" (CNPq, 200233/92), Brazil.

Chaeturginus

The two species here included in *Chaeturginus* share the following diagnostic features: integument very shiny and smooth, mostly or at least partly testaceous; width of subantennal area less than half to about one-fourth the length of inner subantennal suture; lacinia with long, coarse setae; propodeal triangle polished, glabrous; male with gena (lateral view) about half as broad as eye; gonobase

present dorsally; female with distinct stiff bristles ventrally (on premarginal areas of sterna 2–5 in *C. testaceus* or on mesepisternum and premarginal area of sternum 4 in *C. alexanderi*, sp. n.); middle tibial spur of female about as long as basitarsus.

Chaeturginus is most closely related to *Rhophitulus* Ducke and *Cephalurgus* Moure and Oliveira (Ruz, 1986). The male genitalia of these three genera have a small, basal sclerite resembling a vestigial gonobase (see Figs. 13–15). Ruz (1986) considered this sclerite homologous to the gonobase; however, her cladistic analysis shows its presence in this group as a reversal, an evidence that this structure might have no direct relationship to the ordinary hymenopteran gonobase, which is absent in most Panurginae.

The definitions for these three genera presented by Ruz (1986) suggest that recognition of *Chaeturginus* and *Cephalurgus* makes *Rhophitulus* paraphyletic. A more appropriate classification for these and other related taxa, in which only monophyletic groups are recognized, requires additional phylogenetic analyses, a task beyond the scope of the present paper.

Chaeturginus testaceus (Ducke, 1907)
(Figs. 3, 6–8)

This species is unique in having a very elongate glossa (Fig. 6), a feature not reported by Oliveira and Moure (1963). The specimen dissected and illustrated by them probably had the distal part of its glossa broken. The elongation of the glossa is present in both sexes and apparently represents an extreme distal development of its ventral portion (Fig. 8), forming a narrow, tubular extension (Fig. 6). The lateral walls of this tubular extension are formed by what seem to be highly modified, flattened se-

¹ Laboratorio de Zoología, Universidad Católica de Valparaíso, Av. Brasil 2950, Casilla 4059, Valparaíso, CHILE. E-mail: lruz@ucv.cl

² Snow Entomological Collection, Natural History Museum, University of Kansas, Lawrence, KS 66045. Present address: Departamento de Biologia, FFCLRP, Universidade de São Paulo, Av. Bandeirantes 3900, 14040-901, Ribeirão Preto, SP, BRAZIL. E-mail: garmelo@ffclrp.usp.br

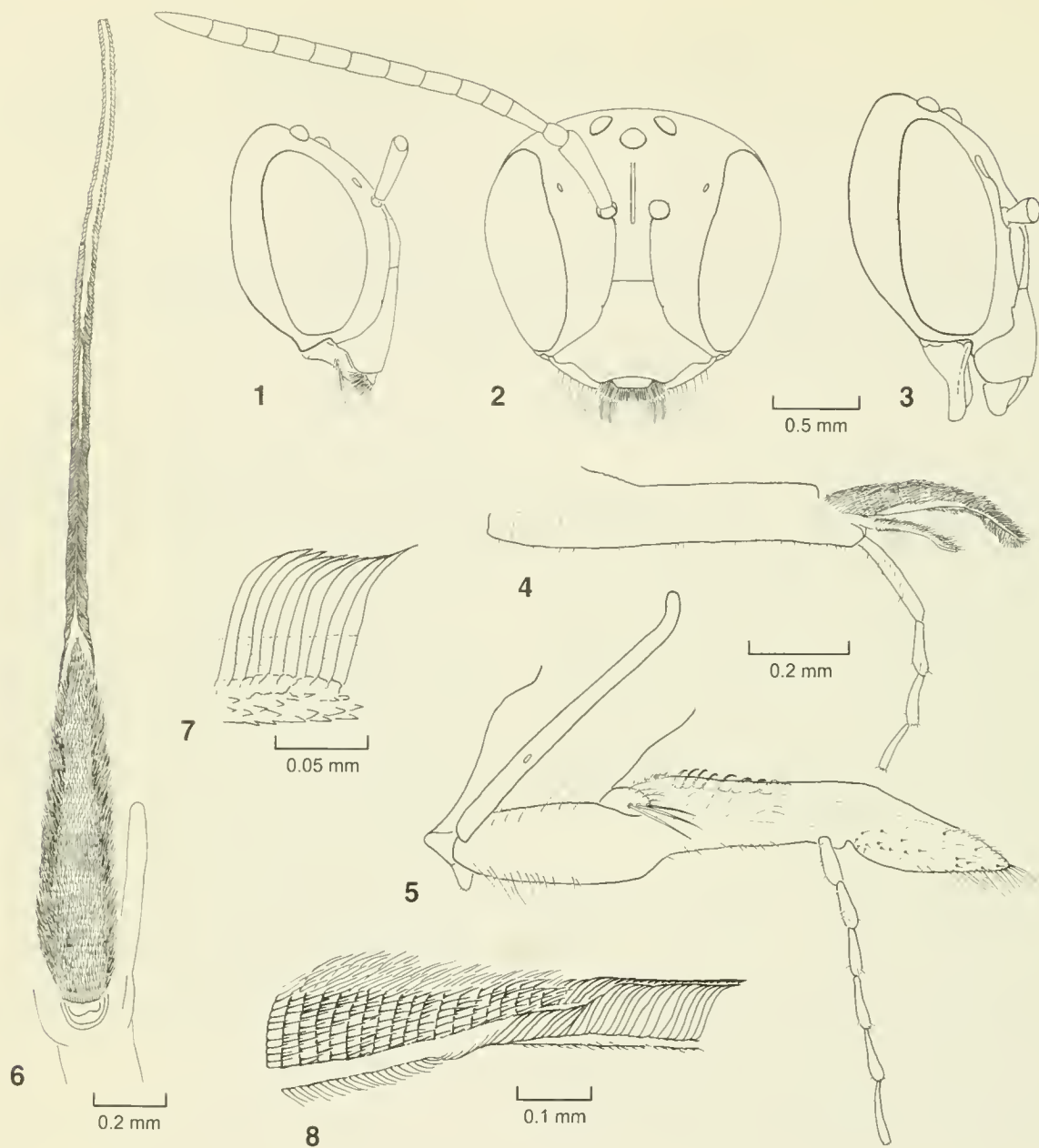

Figs. 1-8. (1, 2, 4, 5) *Chaeturginus alexanderi*, sp.n., male. 1-Head, lateral view. 2-Frontal view. 4-Labium, lateral view. 5-Maxilla, lateral view. (3, 6-8) *Chaeturginus testaceus* (Ducke), male. 3-Head, lateral view. 6-Glossa (tip of distal tubular extension missing), dorsal view. 7-Detail of the flattened, modified setae forming the lateral walls of the distal tubular extension of the glossa, lateral view. 8-Detail of the transition between the basal portion of the glossa and its distal tubular extension, lateral view.

tae (Fig. 7); these modified setae become shorter and have wider bases toward the apex of the glossal extension. The tip of the glossa represented in Fig. 6 is broken and missing; judging by specimens with intact glossae, it seems that less than one seventh of the distal extension is missing.

Ducke (1907) described this species from a series of four males collected on flowers of a species of *Psychotria*

(Rubiaceae) in the shady, swamp-forests of the lower Japurá River (Amazonas State, Brazil). Oliveira and Moure (1963) designated a lectotype in the Museu Goeldi (Belém) and mentioned that the specimen was selected and labelled by J. S. Moure and C. D. Michener in 1955. However, this must have been a mistake because, as published by Nascimento (1979), Moure and Michener selected a neo-

Table 1. Selected body measurements (in mm) of males of *Chaeturginus testaceus* (Ducke).

Measurement	Lectotype	Paralectotype 1 ^a	Paralectotype 2 ^b	"Óbidos" male ^c
Head length	1.18	1.37	1.35	1.32
Width of frons ^d	0.63	0.72	0.68	0.65
Clypeus length	0.39	0.44	0.44	0.44
Clypeus width	0.75	0.86	0.84	0.86
Length of subantennal suture	0.30	0.33	0.33	0.32
Clypeo-ocellar distance	0.67	0.77	0.77	0.75
Distance between tentorial pits	0.33	0.40	0.37	0.39
Width of mesoscutum ^e	0.81	1.00	0.98	1.02

^a Collecting date "16.9.1904"

^b Collecting date "17.9.1904"

^c Óbidos, Pará (Brazil), specimen deposited in the American Museum of Natural History

^d Measured along upper part of epistomal suture

^e Measured between tegulae

type and neallotype from the specimens collected by Ducke in Óbidos [Pará State, Brazil; see Ducke (1913)], probably assuming that the type series was lost. Also, Oliveira and Moure (1963), at the end of their paper, mention that they examined only specimens from Óbidos. Recently, one of us (LR) found three males of the type series from the Rio Japurá in the Museum für Naturkunde (Berlin). One of the specimens was selected and labelled as lectotype and the other two as paralectotypes. Therefore, we consider the "type" material in the Museu Goeldi invalid.

The lectotype here designated has the following original, hand-written labels: "R.[io] Japurá, 16.9.1904, Ducke", second label "Rhopitulus testaceus Ducke, typ.[us]" (plus male symbol). One of the paralectotypes has labels with the same information as for the lectotype. The second paralectotype has a different collecting date, "17.9.1904", and lacks the second identification label. These three specimens show some variation in size and proportions among themselves and in comparison to one male from Óbidos (deposited in the American Museum of Natural History). Table 1 presents some body measurements to illustrate this variation.

Chaeturginus alexanderi, sp. n.

(Figs. 1, 2, 4, 5, 9–15)

DESCRIPTION

Male.—Body length: 5.8 mm; head width: 1.4 mm; forewing length: 4.4 mm.

Coloration: Testaceous, with dark brown on dorsal part of head, including most of antennal flagellum (but last two flagellomeres testaceous), pronotum (distal area), mesoscutum and anterior surface of hind tibia and basitarsus; with following parts yellow: antennal scape (ventral surface), lower two-thirds of paraocular area, clypeus, supraclypeal area, labrum, basal half of mandible,

longitudinal band beside orbit on gena and tip of pronotal lobe.

Pubescence: In general very short, extremely fine and sparse except dense and rather stiff on distal part of labrum (few hairs laterally), longer and somewhat thicker on mandible; very short, dense and appressed to integument on mesoscutum; on mesepisternum, ventrally, very dense and appressed; longer on distal part of scutellum, metanotum and lateral areas of metasomal terga; propodeal triangle glabrous; extremely sparse and minute on most sterna, very short but more noticeable on S3–6, S4 also with row of thicker, apically branched hairs on middle of marginal area (Fig. 9), S5 and 6 with tiny hairs on surface toward midline, more strongly obliquely oriented, longer and denser on laterodistal area (Fig. 10).

Punctuation: Integument shiny and smooth, especially polished on propodeum and metasomal terga. Punctures in general very fine and sparse, somewhat more dense and coarse on clypeus, upper frons medially and mesepisternum anteriorly, very fine on mesoscutum, almost invisible and very sparse on terga, except on lateral areas of last three segments; small, sparse and shallow on sterna but more dense on laterodistal areas on S5 and 6.

Structure: Head broader than long (Fig. 2). Clypeus 1.7× as broad as long, surpassing lower orbital tangent by nearly one-third of its length; in lateral view nonprotuberant, flat, inclined backward (Fig. 1). Labrum slightly more than twice as broad as long, basal area above ridge flattened, distal part reflexed and shorter than basal part, distal margin very slightly convex. Mouthparts (Figs. 4, 5): stipes abruptly narrowed before its midlength; lacinia with three straight, coarse setae much longer than smaller, branched hairs; glossa short, slightly longer than half length of prementum; paraglossa slightly more than twice as long as suspensorium; labial palp with segment 1 shorter than segments 2–4 together. Paraocular area somewhat convex. Antennal sockets above middle of face and area

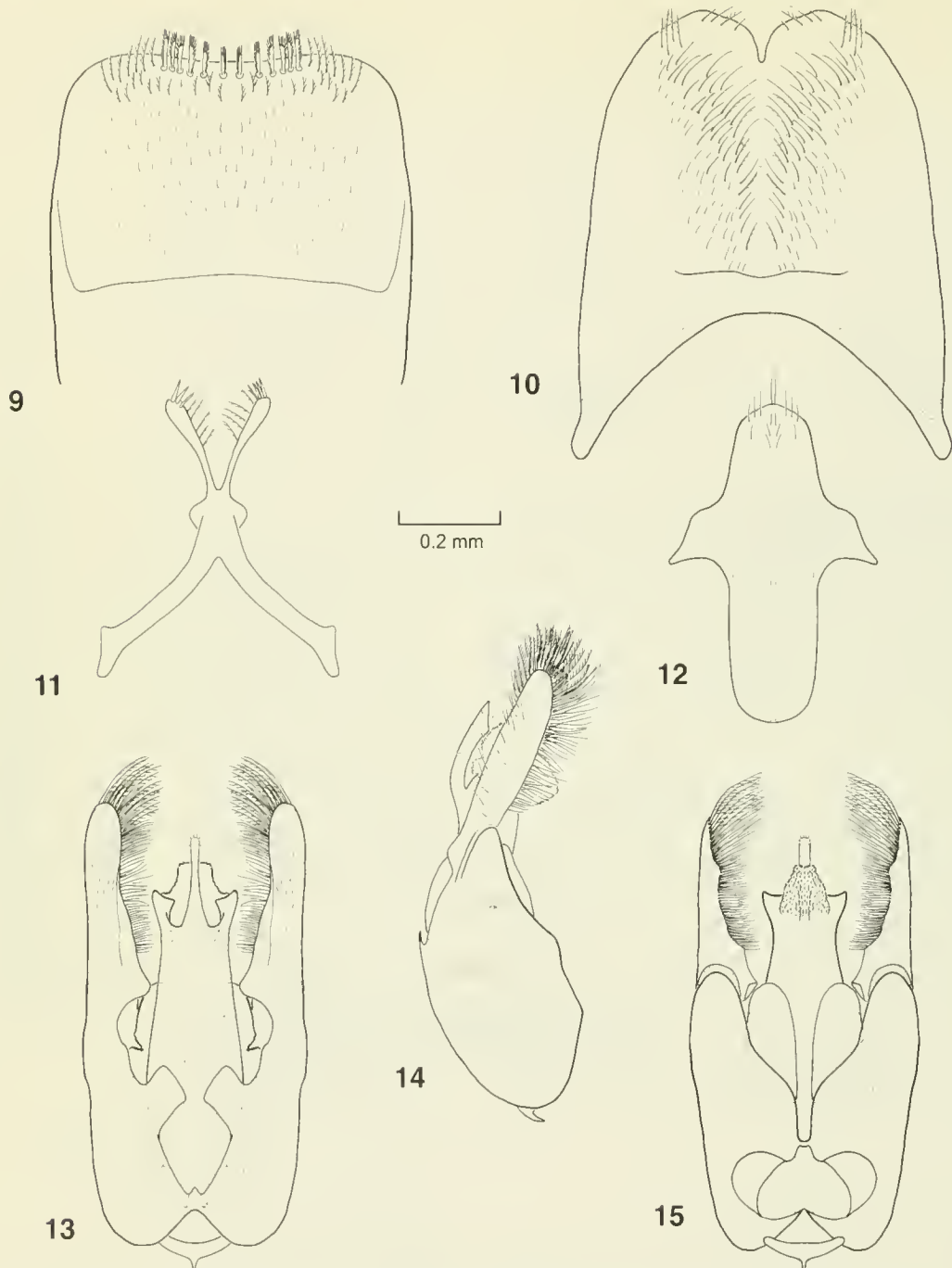

Figs. 9-15. *Chaeturginus alexanderi*, sp. n., male. 9-Sternum 4, ventral view. 10-Sternum 6, ventral view. 11-Sternum 7, ventral view. 12-Sternum 8, ventral view. 13-Genital capsule, dorsal view. 14-Lateral view. 15-Ventral view.

between them distinctly prominent. Antennal flagellum about 1.5× longer than head (Fig. 2); flagellomere 1 about 3× longer than its basal width, distinctly longer than 2. Inner subantennal suture longer than distance between dorsal horizontal part of epistomal suture and tentorial pit; outer subantennal suture almost completely obliterated

(Fig. 2). Distance from inner orbit to antennal socket slightly longer than distance between sockets. Facial foveae small, deep, slightly longer than broad. Eye length about three-quarters of head length; inner orbits sinuous, converging below. Posterior ocelli above dorsal orbital tangent. Gena (maximum width) about one-third as wide as

eye in lateral view. Forewing: Marginal cell about as long as distance from its apex to wing tip; submarginal cell 1 longer than 2 measured along posterior margins. Middle tibial spur shorter than basitarsus, finely serrate. Basitibial plate weakly indicated, with margins carinate only posteriorly. Hind tibia with outer spur shorter and slightly more curved than inner one. Lateral foveae of T2 inconspicuous, weakly depressed. T7 with pygidial plate poorly delimited. S6 with narrow, median marginal emargination (Fig. 10). S7 with distal projections very narrow, delicate (Fig. 11), not lobe-shaped as in *C. testaceus*. S8 and genital capsule as in Figs. 12 and 13–15, respectively.

Female.—Body length: 5.6 mm; head width: 1.6 mm; forewing length: 5.0 mm.

Coloration: Mostly dark brown to black, with following parts reddish testaceous: mouthparts distally, basal half of mandible, scape except for brown distal part, anterior border and lobe of pronotum, bases of wings, legs except for brown hind tarsomeres, propodeum, T1, S1, and pregradular area of S2.

Pubescence: In general short, fine and sparse except dense and rather stiff on distal part of labrum (few hairs laterally); very sparse on mesoscutum; longer on distal part of scutellum, metanotum and lateral areas of metasomal terga, as well as along premarginal lines on T3 and T4. T5 with well-developed fimbria. Propodeal triangle glabrous. Fore coxa and trochanter, mesepisternum ventrally, and posterior marginal areas of S4 and S5 with dense, finely plumose setae, their lateral branches short and almost perpendicular to the axis; S4 and S5 also with numerous stiff setae among finely plumose ones. Mesepisternum, anteriorly, with two medial paired sets of long, spur-like bristles among ventral plumose pubescence, these bristles laminar and curved toward the middle of mesepisternum, opposite bristles with their apices in contact; a few additional shorter, strong bristles near base of mid coxa ventrally also present. Premarginal area of S4 with six to seven stout bristles arranged in a transverse row and forming a distinct rake. Outer surface of hind tibia with a voluminous scopa, formed mostly by long setae gently curved posterad along their apical third and with long branches along outer side of curvature.

Punctuation: Integument shiny and smooth, especially polished on propodeum and metasomal terga. Punctures in general fine and sparse, somewhat more dense and coarse on head and mesepisternum anteriorly.

Structure: Head slightly broader than long. Clypeus twice as broad as long, surpassing lower orbital tangent by nearly one-third of its length, its marginal area relatively long and slightly projecting medially, sulcus separating marginal area from remainder of clypeus strong; in lateral view nonprotuberant, disk somewhat flat. Labrum

and mouthparts as in male. Paraocular area somewhat convex. Antennal sockets above middle of face and area between them distinctly prominent. Antennal flagellum 1.1× longer than head; flagellomere 1 about 3× longer than its basal width, distinctly longer than 2. Inner subantennal suture longer than distance between dorsal horizontal part of epistomal suture and tentorial pit; both subantennal sutures distinctly visible. Distance from inner orbit to antennal socket 1.4× longer than distance between sockets. Facial fovea narrow and deep, almost 5× longer than broad. Eye length about two-thirds of head length; inner orbits sinuous, converging below; in lateral view 1.8× as wide as maximum width of gena. Posterior ocelli above dorsal orbital tangent. Forewing characters as in male. Middle tibial spur slightly longer than basitarsus, pectinate, teeth short (about as long as maximum width of rachis) and arranged in two alternating rows. Basitibial plate rounded distally, with margins carinate. Hind tibial spurs finely serrate and subequal in size. Lateral foveae of T2 small and shallow. Pygidial plate well developed.

Type material.—Holotype male, "Brasil, S.[ão] P.[aulo], Campinas, 15.xii.90–02.i.1991, Alexandre Ruzsarczyk", second label "Reserva Municipal de Santa Genebra, Armadilha Malaise", in the "Museu de Zoologia da Universidade de São Paulo", São Paulo, Brazil. Paratypes: 1 male, "BRAZIL, Varginha: M.[inas] Gerais, Feb. 1972, M. Alvarenga", in the American Museum of Natural History, New York, USA; 1 male, "Belo Horizonte M[inas] G[erais], BRASIL, 30/10/1997, J. C. Moreira", second label "Abelhas da Zona Metalúrgica MG, Pq. Mangabeiras, 2282-7152", 15 males and 4 females, same locality as previous paratype, but specific sites, dates and collectors varying (14 January to 20 February 1999), in the bee collection (F. A. Silveira) of the "Departamento de Biologia", of the "Universidade Federal de Minas Gerais", Belo Horizonte, Brazil.

Etymology.—This species is named in memory of Byron A. Alexander. We feel lucky to have had the opportunity to know and interact with Byron.

DISCUSSION

This species can be easily differentiated from *C. testaceus* by the following characters: top of head, mesoscutum and scutellum dark; glossa shorter than prementum; first antennal flagellomere 3× as long as its basal width; facial fovea deep; female mesepisternum and metasomal segments 2–6 dark; female midtibial spur pectinate; female mesepisternum with distinctly modified bristles; stout bristles on female metasoma restricted to S4; male antennal flagellum about 1.5× as long as head; male clypeus less than twice as broad as long, in lateral view flat and inclined backward; male outer subantennal su-

ture almost completely obliterated; male metasomal S4 with transverse row of thick and apically branched hairs on marginal area.

In Belo Horizonte, males and females of *C. alexanderi* were collected on flowers of one unidentified species of Rubiaceae and one of Polygalaceae, both species growing as understory herbs in forested areas (G. Souza, J. C. Moreira and F. S. Silveira, pers. comm.).

LITERATURE CITED

Ducke, A. 1907. Beitrag zur Kenntnis der Solitärbiene Brasiliens. Zeitschrift für systematische Hymenopterologie und Dipterologie

7: 361-368.

Ducke, A. 1913. Die natürlichen Bienengenera Südamerikas. Zoologische Jahrbücher, Abteilung für Systematik, Geographie und Biologie der Tiere 34: 51-116.

Nascimento, P. T. R. 1979. Catálogo de tipos entomológicos do Museu Goeldi. Hymenoptera. Boletim do Museu Paraense Emílio Goeldi (N. S.), Zoologia 98: 1-18.

Oliveira, B. L. and J. S. Moure. 1963. Nova posição sistemática para *Rhopitulus testaceus* Ducke, 1907 (Hym., Apoidea). Anais da Academia Brasileira de Ciências 35: 575-584.

Ruz, L. 1986. Classification and phylogenetic relationships of the panurgine bees (Hymenoptera, Andrenidae). Ph. D. dissertation. Department of Entomology, University of Kansas, Lawrence, USA.

Prolegs of Papilionini (Lepidoptera: Papilionidae): Alternative Solutions to the Problem of Attachment

By

ROBERT H. HAGEN¹

ABSTRACT Mature larvae of some swallowtail butterflies in the tribe Papilionini (Papilionidae) rest on the surface of leaves between feeding bouts, whereas larvae of other species rest on stems or leaf petioles. Differences in resting site are correlated with differences in larval proleg morphology. Among North American papilionines, larvae of the *glaucus* and *troilus* species groups rest on the upper surface of host plant leaves. Mature larvae spin a silk pad on the leaf, then anchor themselves by hooking medial and lateral rows of proleg crochets into the silk meshwork. In contrast, mature larvae of the *crisphontes* and *machaon* species groups rest on leaf petioles, branches, or stems of their host plants. The substrate is clasped between opposed pairs of prolegs, which have only a medial row of crochets. Larvae of these species groups spin a silk pad as an anchor only when molting.

The differences can be viewed as alternative solutions to the attachment problem that is faced by a large larva feeding externally on plant tissues. One consequence is that leaf-resting and stem-resting larvae must match different backgrounds in order to avoid detection by visually searching predators. Leaf-resting larvae tend to be green dorsally, whereas stem-resting larvae have contrasting stripes or blotches. Because the phylogeny of Papilionini is poorly understood at present, the evolutionary history of these alternative solutions is uncertain.

Keywords: Swallowtail butterflies; *Papilio*; Larvae; Silk; Crochets; Morphology; Evolution; Behavioral ecology.

INTRODUCTION

Attachment to the host is one of the fundamental problems confronting phytophagous insects (Southwood, 1973). Successful exploitation of leaves and stems by free-living insects has been dependent on the evolution of specialized morphology and behaviors for maintaining contact with the host. Despite their importance, adaptations for attachment have received relatively little attention from evolutionary biologists. The most obvious features tend to be similar within broad lineages of phytophagous insects and are seldom regarded as key factors in host plant specialization. However, significant variation does occur within these general adaptations. The study of such variation can provide unique insight into the evolution of complex adaptations (Coddington, 1994; Wenzel, 1993).

The attachment of free-living lepidopteran larvae depends on abdominal prolegs and silk produced by a labial spinneret (Stehr, 1987). Lepidopteran prolegs consist of a basal region, formed of moderately sclerotized cuticle similar to that elsewhere on the abdomen, and a flexible apical region (planta) formed of unsclerotized cuticle. In most species, sclerotized hooks (crochets) are anchored around part or all of the plantar margin. The arrangement of crochets varies greatly among lepidopteran taxa (Stehr, 1987: 294). Crochets enhance the holding potential of the pro-

legs; most taxa that lack them feed internally on their host plants (Stehr, 1987).

Two general types of lepidopteran proleg were recognized by Hinton (1952). The first is a "gripping" proleg, which has a symmetrical peg-like shape with crochets that form either a complete circle, a broken circle (penellipse), or medial and lateral rows (mesoserries plus lateroserries) around the planta (Figs. 1–2). The second is a "clasping" proleg, which is tilted toward the midline and has crochets restricted to a band on only the medial side of the planta (mesoserries: Figs. 3–4).

In both types of proleg, contraction of muscles attached to the center of the planta disengages the crochets and lifts the proleg away from the substrate (Fig. 3; Hinton, 1952). When these muscles are relaxed, hemolymph pressure extends the proleg, everts the planta, and enables the crochets to re-engage the substrate (Fig. 4). The types differ in that clasping prolegs function primarily as opposable pairs to clasp the substrate (a stem, petiole or leaf edge) against the ventral midline (Figs. 5–6). In contrast, each gripping proleg can act independently: when extended, the crochets hook under silk threads anchored to the substrate (Figs. 7–8).

Larvae with clasping prolegs can cling more firmly to thin twigs than can larvae with gripping prolegs. Hinton

¹ Department of Entomology, Haworth Hall, University of Kansas, Lawrence, KS 66045-2106. E-mail: rhagen@ukans.edu

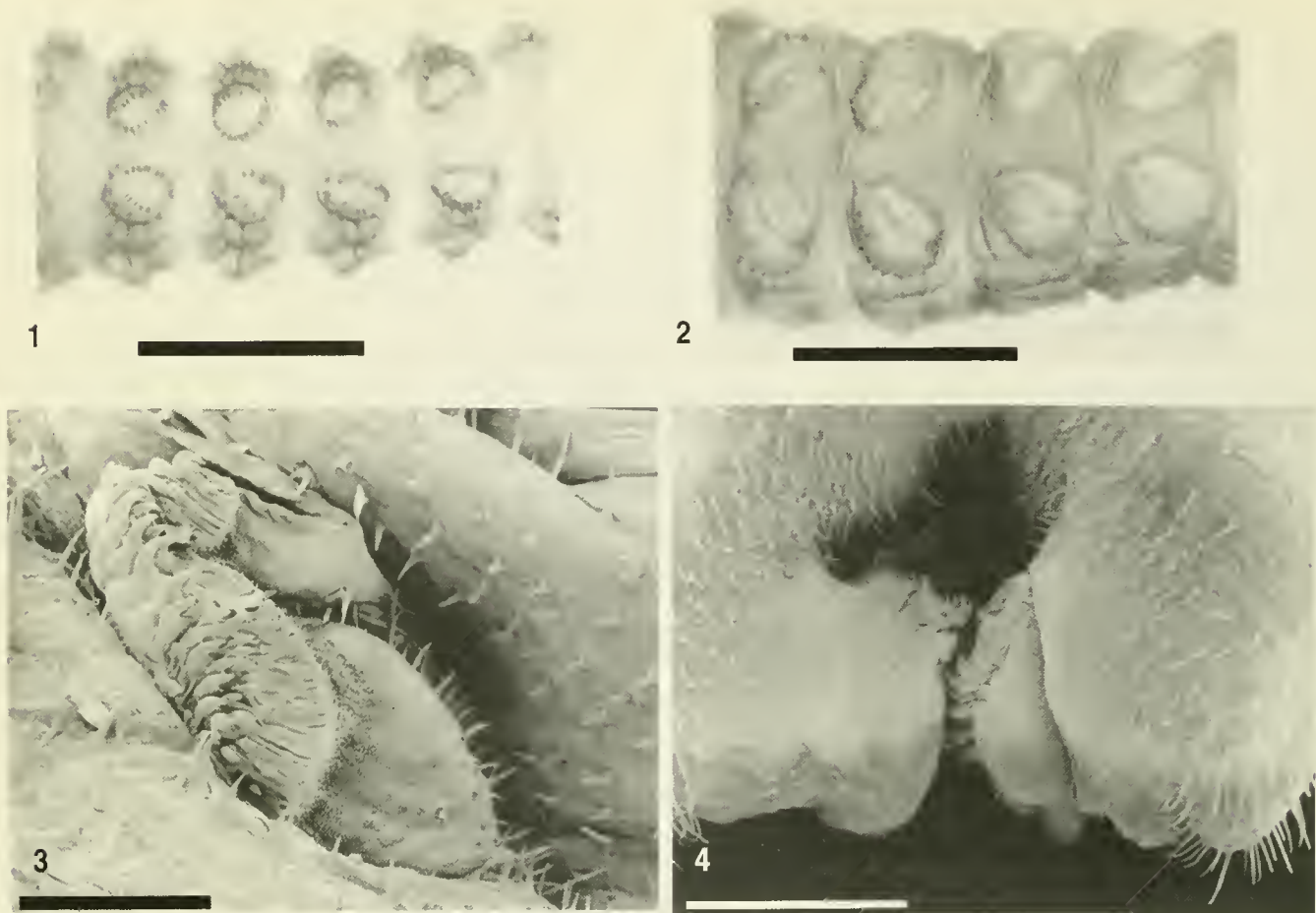

Figs. 1-4. 1-2. Prolegs on abdominal segments 3 to 6 of 1st instar larvae. (Scale bars = 0.5 mm.) 1-*P. polyxenes*. 2-*P. glaucus*. 3-4. S.E.M. views of clasping prolegs of lyophilized 5th instar *P. polyxenes* larvae. 3-Fully retracted proleg. (Scale bar = 0.5 mm.) 4-Proleg pair, fully extended; in life, crochets would be engaged in the substrate. (Scale bar = 1 mm.)

(1952) noted that the clasping proleg is well suited for larvae that move about freely on plants (he referred to it as a "climbing" proleg). Clasping prolegs occur in Geometroidea, Noctuoidea, Bombycoidea, Sphingoidea, Zygaenidae and mature larvae of most Papilionoidea (Hinton, 1952; Stehr, 1987). Gripping prolegs occur more commonly among taxa with larvae that live in leaf rolls or other shelters (e.g., Tortricoidea, Pyraloidea). Hinton (1952) and others (Forbes, 1951) argued that the gripping proleg is ancestral for Lepidoptera, and referred to it as the "primitive" type.

Hinton's (1952) discussion of prolegs was focused on their utility as characters for lepidopteran systematics; he was particularly concerned to refute any claim that the clasping type defined a monophyletic group within the Lepidoptera. Part of Hinton's argument for multiple origin of clasping prolegs was based on the occurrence of both types among swallowtail butterfly larvae in the tribe Papilionini (Papilionidae).

Hinton noted that, in common with other butterfly larvae, early instar papilionines have gripping prolegs with a complete or nearly complete circle of crochets. In successive instars of most butterfly species, crochets on the lateral side of the planta become progressively less numerous and smaller until they are lost, while crochets on the medial side become more robust. The result by the final instar is a characteristic clasping proleg. Larvae of the swallowtail butterfly *Papilio polyxenes* L., and other species in the *machaon* group, undergo this ontogenetic transformation (cf. Figs. 1 and 9)

However, larvae belonging to two other North American papilionine species groups (Forbes, 1951; Hinton, 1952) retain the gripping proleg type throughout larval development. This pattern is shown by *Papilio (Pterourus) glaucus* L. (cf. Figs. 2 and 13).

Papilionini includes *Papilio* (sensu lato), with approximately 220 species distributed worldwide and, possibly, *Meandrusa* with 2 Asian species (Miller, 1987; Scriber, 1995).

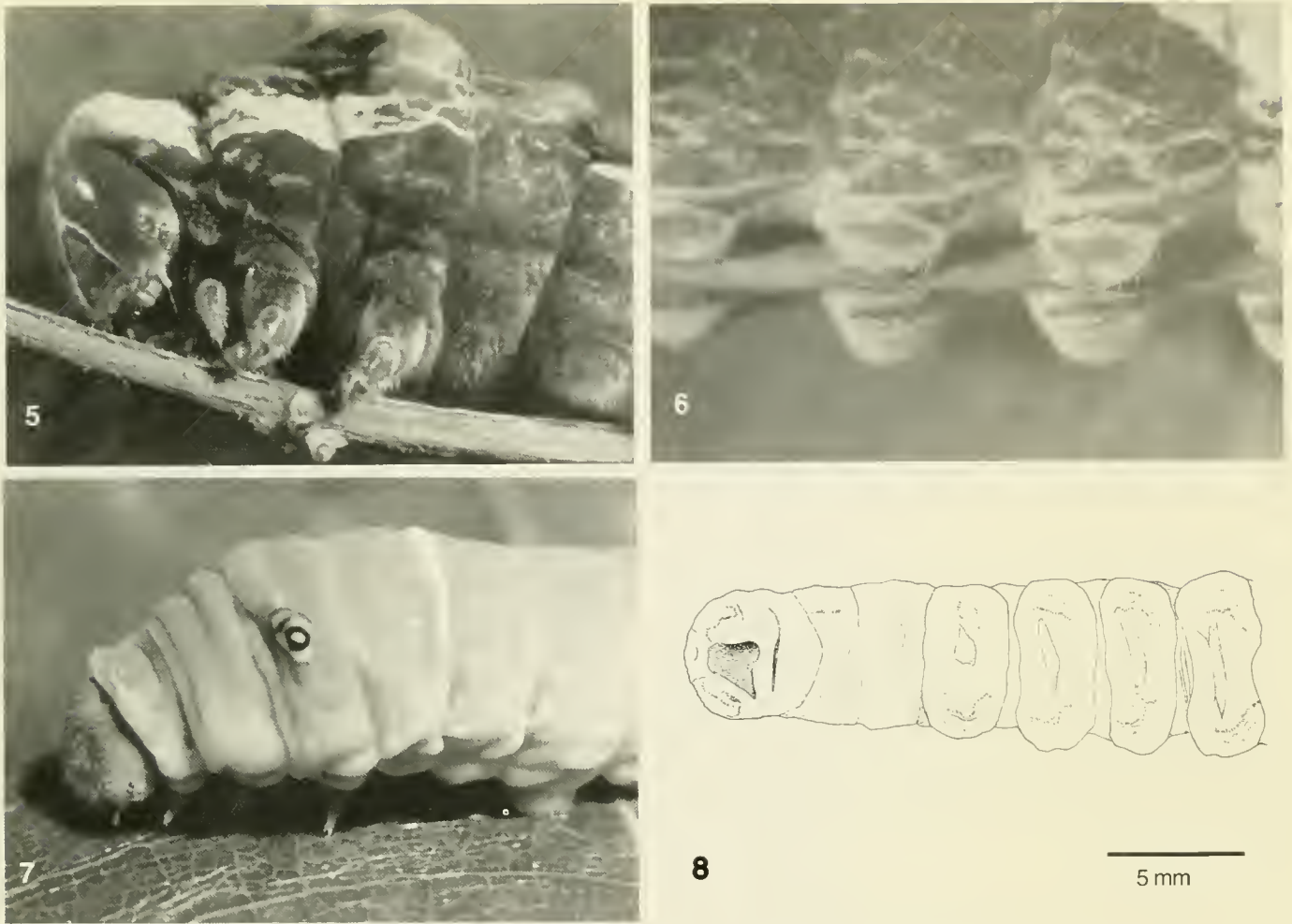

Figs. 5-8. 5-6. *P. cresphontes*, 5th instar larva, lyophilized, in resting position on petiole of *Zanthoxylum americanum*. 5-Anterior. 6-Abdominal segments 3-6, prolegs extended to clasp petiole. 7-8. *P. glaucus*, 5th instar larva. 7-Lateral view of larva on leaf in rearing dish. 8-Ventral view of larval prolegs extended to grip silk. A camera lucida drawing of the abdomen of a resting larva suspended from a silk pad that it had anchored to the transparent lid of a rearing dish.

Hancock (1983), following Munroe (1961) and earlier workers, recognized 42 species groups within *Papilio* (s.l.), each comprising 1-15 species. Phylogenetic relationships among species groups are uncertain. Although Hancock split *Papilio* (s.l.) into 6 genera and 8 subgenera (Table 1), most of these are poorly supported. A more recent treatment of New World swallowtails (Tyler et al., 1994) provides illustrations of larval stages for many taxa and highlights some of the areas of continuing uncertainty in papilionid systematics.

The best supported clades within *Papilio* s.l. are *Heraclides*+*Eleppone*+*Chilasa*, *Princeps*, and *Papilio* (s.s.); Hancock's *Pterourus* may not be monophyletic (Table 1). Relationships among and within these lineages are uncertain, and the subgenera identified by Hancock (1983; Table 1) and Tyler et al. (1994) are problematic. Within *Pterourus*, the *glaucus*, *scamander*, and *homerus* species groups com-

prise a clade distinct from the *troilus* group (Caterino and Sperling, 1999; Reed and Sperling, 1999).

Variation in proleg morphology among *Papilio* species presents functional and evolutionary questions that have not been addressed previously: What is the relationship between proleg morphology and larval behavior? In what direction, and through what stages, did the differences in these adaptations evolve? Forbes (1951) observed that the gripping prolegs of mature larvae of the *glaucus* and *troilus* groups are an adaptation for walking on a silk sheet anchored to host plant leaves. However, he did not discuss larval behavior or function in any detail, nor did he make comparisons among species.

In this paper, I argue that loss and retention of gripping prolegs represent alternative solutions to the problem of attachment faced by a large larva. The observations of larval behavior and external morphology reported here

were made in the course of other studies on ecology and evolution of North American *Papilio* species (Hagen and Lederhouse, 1985; Hagen, 1986; Hagen and Scriber, 1991, 1995; Scriber et al., 1991). Information for additional taxa was gleaned from published larval descriptions (Bell, 1912a,b; Talbot, 1939; van Son, 1949; Clarke et al., 1963; Igarashi, 1979; Turner, 1991; Tyler et al., 1994).

ACKNOWLEDGMENTS

This study originated with observations made while I was a student in the Department of Ecology and Systematics at Cornell University; Paul Feeny introduced me to swallowtail biodiversity and provided some of the larvae that I used. Early discussions with James S. Miller and Felix Sperling helped me appreciate problems in swallowtail systematics. Also at Cornell, Jean Fincher helped me obtain SEM pictures of larvae. I was able to continue the work, off and on, while affiliated with the Entomology Department at Michigan State University and the Museum of Zoology at the University of Michigan. At MSU, Mark Scriber created a stimulating environment for swallowtail research and provided access to additional specimens and microscopes. Keith Brown and Steve Passoa provided neotropical larvae for examination, and Mamoru Watanabe contributed observations on Japanese species. I assembled the assorted pieces at the University of Kansas, with help from Chris Haufler, Sara Taliaferro, and George Byers. With remarkable tolerance, Deborah Smith has served as critic and occasional assistant throughout the long and fitful process.

During the latter phase of the project, Byron Alexander allowed me to use his microscope and camera to photograph prolegs. More importantly, I was inspired to continue by Byron's enthusiasm for combining systematics, morphology, and behavior in evolutionary studies. This project has enabled me to explore a small corner of that world.

METHODS AND MATERIALS

I selected 4 species for intensive study, as representatives of each of the *Papilio* species groups occurring in North America (Table 1): *Papilio* (*Pterourus*) *glaucus* L. (*glaucus* group), *Papilio* (*Pterourus*) *troilus* L. (*troilus* group), *Papilio* (*Papilio*) *polyxenes* Fabr. (*machaon* group), and *Papilio* (*Heraclides*) *cresphontes* Cramer (*thoas* group). Additional observations were made on behavior of *Papilio* (*Pterourus*) *palamedes* Drury (*troilus* group) and *Papilio* (*Pterourus*) *scamander* Boisduval (*homerus* group).

I was able to examine preserved mature larvae of *Papilio* (*Heraclides*) *anchisiades* Esper (*anchisiades* group) (El Zamorano, Honduras: S. Passoa, coll.), *Papilio* (*Heraclides*) *hectorides* Esper (*torquatus* group) (Serra Negra, São Paulo, Brasil: K. L. Brown, coll.), and *Papilio* (*Heraclides*) *thoas* L.

(*thoas* group) (Serra Negra, São Paulo, Brasil: K. L. Brown, coll.).

The *P. glaucus* larvae used for morphological study were offspring of mated females collected in Union Co., Georgia, and reared in the laboratory on foliage of white ash (*Fraxinus pennsylvanicus* Marsh.) and black cherry (*Prunus serotina* Ehrh.). Extensive observations of larval behavior were made in the course of other studies on this species (Hagen, 1986). The *P. troilus* larvae used for morphology were offspring of mated females collected in Union Co., Georgia, and reared in the laboratory on foliage of sassafras (*Sassafras albidum* [Nutt.] Nees); additional observations of larval behavior were made in the field in Davidson Co., Tennessee. Larvae of *P. palamedes* were observed in the field and laboratory on foliage of red bay (*Persea borbonia* [L.] Spreng.) in Highlands Co., Florida. Eggs and larvae of *P. polyxenes* were obtained from a culture maintained at Cornell University, Tompkins Co., New York, and observed in the greenhouse on parsley plants (*Petroselinum crispum* [P. Mill.] Mansf.) (Carter and Feeny, 1985). Larvae of *P. cresphontes* were observed in the field and laboratory on foliage of prickly ash (*Zanthoxylum americanum* P. Mill.) in Washtenaw Co., Michigan. Limited observations were also made on behavior of mature larvae of *P. scamander*, offspring of a female collected in Campinas, São Paulo, Brasil, by K. L. Brown, which were reared in a small container in the laboratory on red bay foliage (Scriber et al., 1990 [1991]).

Specimens used for scanning electron microscopy (SEM) were killed by freezing at -80°C , then lyophilized. Other specimens were killed by immersion in near-boiling water, then preserved in 70% aqueous ethanol. Preparations of ventral abdominal cuticle were made by dissecting preserved specimens to remove internal organs and most muscle tissue, then cleared by soaking overnight in 5% aqueous KOH solution before photographing.

Descriptions of behavior are based on larvae observed either under natural conditions in the field, or under semi-natural conditions in the laboratory or greenhouse after being placed on potted host plants (*P. polyxenes*) or on small branches cut from host trees (other species). Larvae placed on host foliage under semi-natural conditions were allowed to acclimate for several hours before observations began; host tree branches were inserted into water-filled vials to maintain foliage condition (Carter and Feeny, 1985).

Because the purpose of the observations was a qualitative comparison of behavior among species, descriptions were synthesized from independent observations of several to many larvae. I distinguish between the behavior of "young" larvae, those in the first, second, and third instars (5–15 mm long), and "mature" larvae, those in the fourth and fifth instars (25–50 mm long). I did not record

Table 1. Characters of papilionine larvae. Classification of the tribe is provisional and follows the the generic and subgeneric assignments of Hancock (1983). All genera and subgenera are represented, but not all species groups; only one or two species from each species group are included. Color pattern refers to categories of dorsal color pattern of the final instar larva described in the text. Resting site refers to the preferred resting site of final instar larvae; "pad" indicates that the larva is reported to spin a silk pad as an attachment aid. Sources for species not included in this study: ^a Tyler, et al. (1994); ^b Turner (1991); ^c Igarashi (1979); ^d Talbot (1939); ^e Clarke et al. (1963); ^f van Son (1949); ^g M. Watanabe, personal communication; ^h Bell (1912a); ⁱ Bell (1912b). *See discussion in text.

Genus	(Subgenus)	Species Group	Species	Color Pattern	Crochet Rows	Resting Site
<i>Pterourus</i> Scopoli	<i>(Pterourus)</i>	glaucus	<i>glaucus</i>	green	2	pad; upper leaf
		troilus	<i>troilus</i>	green	2	pad; upper leaf
		troilus	<i>palamedes</i>	green ^a	2	pad; upper leaf
	<i>(Pyrrhosticta</i> Butler)	scamander	<i>scamander</i>	part-green ^a	2	pad; upper leaf
		homerus	<i>homerus</i>	part-green ^b	2 ^{b*}	pad; upper leaf ^b
<i>Heraclides</i> Hübner		thoas	<i>creosphontes</i>	non-green	1	petiole or twig
		thoas	<i>thoas</i>	non-green ^a	1	—
		anchisiades	<i>anchisiades</i>	non-green ^a	2 [*]	group; trunk [*]
		torquatus	<i>hectorides</i>	non-green ^a	1	—
<i>Eleppone</i> Hancock		anactus	<i>anactus</i>	non-green ^c	—	—
<i>Chilasa</i> Moore	<i>(Chilasa)</i>	laglaizei	<i>laglaizei</i>	non-green ^{ac}	—	—
		clytia	<i>clytia</i>	non-green ^d	—	upper leaf ^h
	<i>(Aeghiana</i> Matsumura)	elwesi	<i>maraho</i>	part-green ^c	—	—
<i>Papilio</i> (L.)		machaon	<i>polyxenes</i>	non-green ^a	1	stem
<i>Priniceps</i> Hübner	<i>(Sinoprinceps</i> Hancock)	xuthus	<i>xuthus</i>	part-green ^{ac}	—	pad; upper leaf ^{g*}
	<i>(Menelaides</i> Hübner)	protenor	<i>protenor</i>	part-green ^c	—	pad; upper leaf ^{g†}
		memnon	<i>memnon</i>	part-green ^e	—	—
		memnon	<i>polymnestor</i>	green ^d	—	petiole or twig ^h
		helenus	<i>helenus</i>	part-green ^{ac}	—	pad; upper leaf ^{g*}
		nephele	<i>dravidarum</i>	green ^d	—	twig or stem ^d
		polytes ⁱ	<i>polytes</i>	part-green ^e	—	petiole or twig ^h
		fuscus	<i>fuscus</i>	non-green ^c	—	—
		aegeus	<i>gambrisius</i>	non-green ^t	—	—
	<i>(Druryia</i> Aurivillius)	cynorta	<i>echerioides</i>	non-green ^t	—	—
		nireus	<i>nireus</i>	part-green ^t	—	—
	<i>(Princeps)</i>	demoleus	<i>demodocus</i>	part-green [*]	—	—
		menestheus	<i>ophidicephalus</i>	part-green ^t	—	—
		phorcas	<i>dardanus</i>	non-green ^t	—	—
		paris	<i>paris</i>	green ^d	—	upper leaf ^h
		paris	<i>bianor</i>	green ^{ce}	—	—
	palinurus	<i>buddha</i>	green ^d	—	pad; upper leaf ⁱ	

quantitative details of the behaviors. Line drawings of larvae on host foliage were traced from color slide photographs. In his 1889 monograph, Scudder gave accounts of the larval behavior of *P. glaucus*, *P. troilus*, *P. creosphontes*, and *P. polyxenes*. The observations recorded here agree in general with Scudder's but are focused on attachment behavior and emphasize comparison among species.

RESULTS

PROLEG MORPHOLOGY

Prolegs on abdominal segments 3–6 of mature *Papilio*

larvae have either one (Figs. 9–11) or two (Figs. 12–15) rows of crochets. The crochets of all 1-row species are larger than those of the 2-row species, with the exception of *P. anchisiades* (Fig. 12). Unlike the other 2-row species, in *P. anchisiades* the crochets of the medial and lateral rows differ greatly in size: those of the lateral row are greatly reduced, whereas those of the medial row are approximately equal to those of the 1-row species. The crochets of *P. palamedes* (2 rows) are very similar to those of its close relative *P. troilus* (Table 1). The crochets of *P. thoas* (1 row) also resemble those of the related *P. creosphontes*.

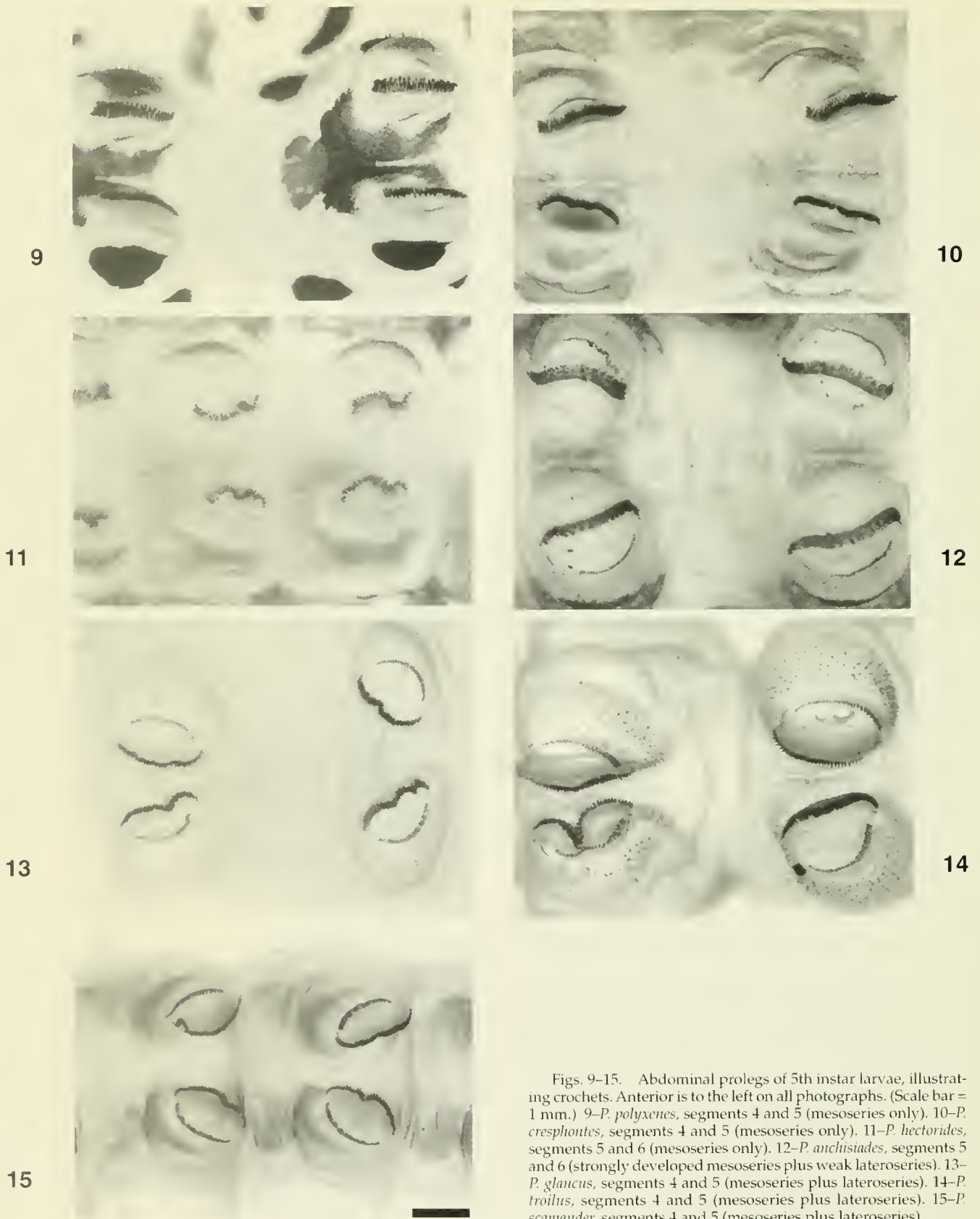

Figs. 9-15. Abdominal prolegs of 5th instar larvae, illustrating crochets. Anterior is to the left on all photographs. (Scale bar = 1 mm.) 9-*P. polyxenes*, segments 4 and 5 (mesoseries only). 10-*P. cresphontes*, segments 4 and 5 (mesoseries only). 11-*P. Hectorides*, segments 5 and 6 (mesoseries only). 12-*P. anchisiades*, segments 5 and 6 (strongly developed mesoseries plus weak lateroseries). 13-*P. glaucus*, segments 4 and 5 (mesoseries plus lateroseries). 14-*P. troilus*, segments 4 and 5 (mesoseries plus lateroseries). 15-*P. scamander*, segments 4 and 5 (mesoseries plus lateroseries).

When the proleg is fully extended, the orientation of its base and planta differed between mature larvae of *P. polyxenes* and *P. glaucus*, in contrast to the similarity between young larvae (Figs. 1–2). In mature *P. polyxenes*, the lateral side of the base is longer than the medial, which causes the plantae of opposing prolegs to face each other when extended (Fig. 4). In *P. glaucus*, the sides of the proleg base are more nearly equal; the fully extended plantae face straight out from the body's axis. The orientation of the extended prolegs of *P. troilus* appears similar to that of *P. glaucus*, and the orientation of prolegs of *P. cresphontes* is similar to that of *P. polyxenes*.

LARVAL COLOR PATTERN

There is extensive variation in the color patterns of mature papilionine larvae (cf. figures in Clarke et al., 1963; Igarashi, 1979; Opler, 1992; Minno and Emmel, 1992b; Tyler et al., 1994). Elements of the color pattern have been proposed as characters for systematics (Hancock, 1983; Tyler et al., 1994). On a functional level, the diversity can be simplified by grouping color patterns into 3 categories based on the dorsal appearance of the final instar larva. "Green": Larva is almost entirely green, with contrasting colors confined to small areas or narrow bands (e.g., eyespots on metathorax: *P. glaucus*, Fig. 7). "Part green": Larva has a mostly green background color that is interrupted by one or a few broad bands or blotches of contrasting color across the thorax or abdomen (e.g., *P. homerus*; Turner, 1991: 262; Tyler et al., 1994: plate 47). "Non-green": Larva has a striped or blotchy pattern with no large areas of green color (e.g., *P. cresphontes*, Fig. 5). The green and part green categories intergrade, and may be regarded as regions along a continuum of pigmentation. The non-green category is more heterogeneous; it includes species which lack green pigmentation entirely and others in which areas of green pigmentation are broken by many contrasting bands (e.g., *P. polyxenes*; Opler, 1992: plate 2). Published illustrations and descriptions of papilionine larvae were used as the basis for assigning species to color pattern categories (Table 1). For the most part, color patterns are similar within species groups.

LARVAL BEHAVIOR

P. polyxenes.—Young larvae often rest on flat upper leaf surfaces between feeding bouts, anchored by sparse threads of silk attached to the leaf. Resting sites are not reused; often when they finish feeding, young larvae merely turn to a head-upwards position (usually, facing the petiole). After a few bouts of feeding the original resting area is consumed along with the leaf under it. Mature larvae rest between feeding bouts on stems, petioles, or leaflet petiolules with head facing upwards (cf. Opler, 1992: plate 2; Tyler et al., 1994). In a typical sequence after feed-

ing, a mature larva crawls partway down the stem, then turns to face upwards, meanwhile depositing a loose network of silk threads onto the stem under itself. The tarsal claws and proleg crochets hook under this network, while simultaneously pressing into the stem to clasp it against the ventral midline. Mature larvae do not regularly reuse resting sites.

Larvae preparing for a molt deposit additional silk onto the plant to form a smaller, denser silk pad in which to anchor the crochets and tarsal claws. The denser pad presumably enables the larva to relax its clasping hold on the plant during the molt—while supported by the old crochets—and to more easily shed the old exoskeleton. A similar dense silk pad is produced at the end of the larval period in preparation for the pupal molt.

P. cresphontes.—Young larvae rest along the midvein of the upper surface of prickly ash leaflets, with head facing the leaf rachis. Silk threads are deposited to form a small pad for attachment to the leaflet surface. Resting sites are not reused, but the larva remains on the same leaflet until it has been consumed before moving to a new leaflet.

Mature larvae typically rest on the upper side of small horizontal branches of prickly ash. Prolegs and legs clasp a leaf rachis or a branch against the midline to anchor the larva while resting (Figs. 5–6; Opler, 1992: plate 2; Tyler et al., 1994). Resting sites do not appear to be regularly reused. Silk pads are not typically spun for attachment while resting. I was unable to observe molting behavior.

P. glaucus.—Young larvae rest between feeding bouts on a silk pad, typically on or near a major leaf vein, with head towards the leaf or leaflet base (Figs. 16–17). The pad is formed as the terminus of silk trails that lead to one or more feeding sites at the leaf margin. The feeding site is usually distal to the resting site, but larvae do not appear to follow a consistent pattern of feeding. A larva may make repeated visits to one feeding site (e.g., Fig. 16), or successively start and abandon several sites around the leaf (e.g., Fig. 17). Feeding often starts from previously damaged leaf edges. Young larvae typically remain on the same leaf through the first two instars after hatching, often 7 days or more.

During the third instar, the larval color pattern begins to change from a brown or black bird-dropping mimic to the green mature larval pattern (Scudder, 1889). The pattern change is usually complete by the middle of the fourth instar, when the larva reaches approximately 25 mm in length. The change in color pattern is associated with a change in behavior.

Mature larvae also construct silk pads for resting, but use different leaves for feeding. Silk threads that comprise the pad are laid down with wide sweeping motions of the head and thorax and are anchored to the leaf surface at

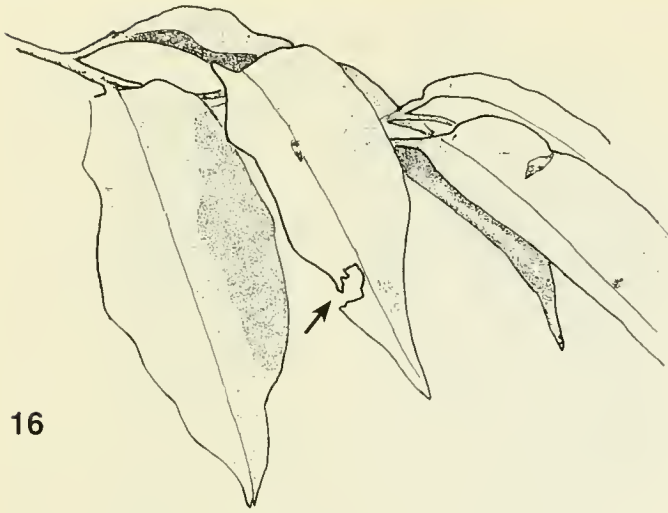

16

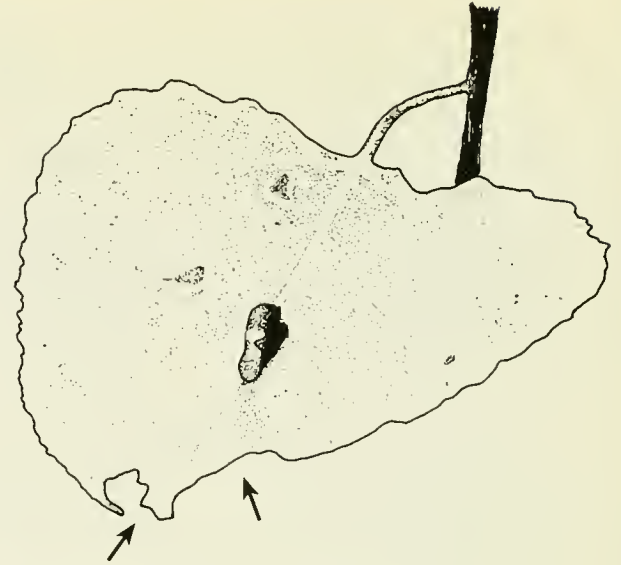

17

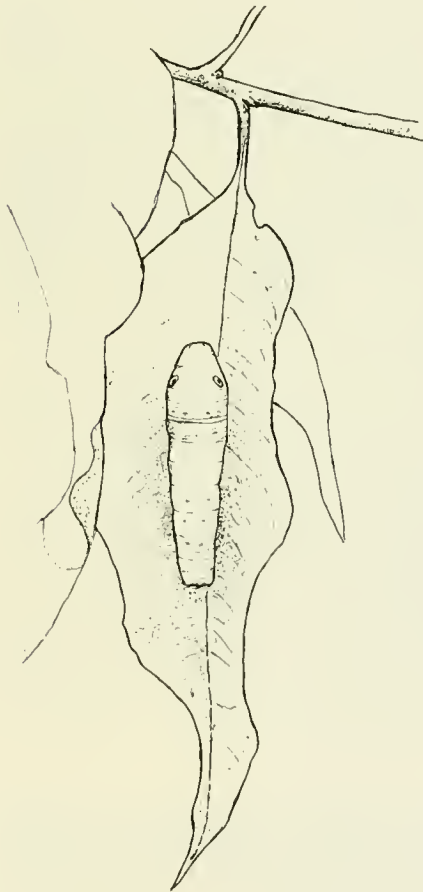

18



19

Figs. 16-19. *Papilio glaucus*, larvae on host plants, illustrating characteristic resting behavior and feeding damage. (Drawn from color photographs, Ithaca, New York, July 1983.) 16-First instar larva on *Prunus serotina*, arrow indicates feeding site. 17-First instar larva on midrib of *Populus tremuloides*, arrows indicate feeding sites. 18-Fifth instar larva resting on leaf. 19-Feeding behavior of 5th instar larva; the larva has finished feeding on a leaf (only the midrib remains) and has begun to chew off the petiole.

the start and end of each sweep. The pad covers most of the upper surface of the leaf or leaflet used for resting (Fig. 18).

Initial construction of the pad takes several minutes during which the larva lays silk from the leaf base towards the leaf tip. At first the prolegs clasp the leaf petiole, but as the silk meshwork is reinforced by repeated sweeps, the

larva gradually moves out onto the leaf surface, and the proleg crochets engage the silk. When the larva is fully supported by the silk pad, it turns around to face the leaf base, meanwhile continuing to add silk to the mesh with wide sweeps.

Once the larva has achieved a "head-up" position facing the leaf base it stops laying silk. (Under natural condi-

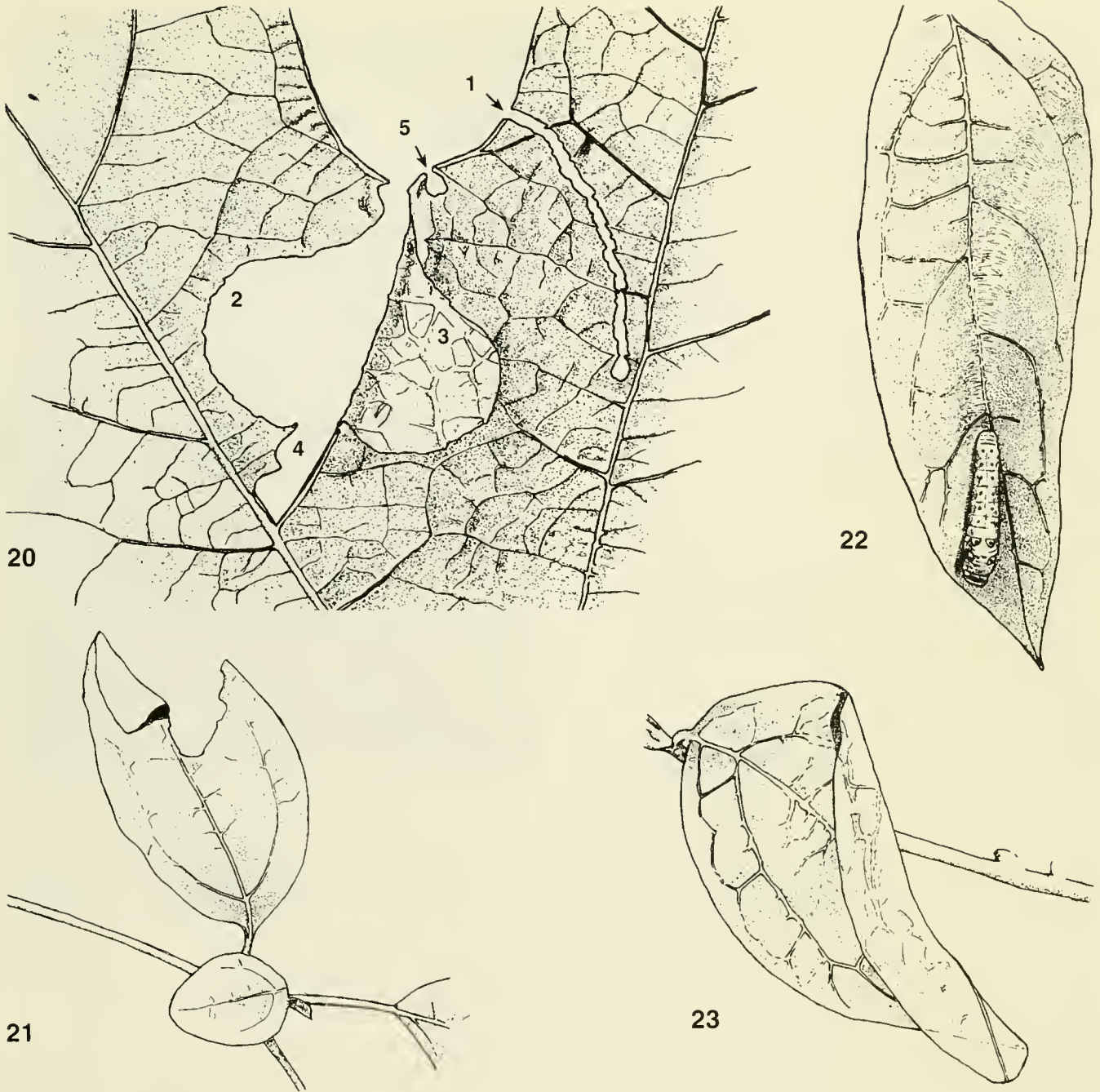

Figs. 20-23. *Papilio troilus*, larvae on host plants, illustrating characteristic resting behavior. 20-Feeding damage and retreat formed by 2nd instar larva on sassafras leaf in laboratory. (1) initial feeding cut, abandoned; (2) outline of feeding cut that freed the leaf flap; (3) leaf flap, covering the silk pad located along vein that marks the fold; (4) expansion of narrow cut by feeding after completion of the fold; (5) start of feeding area that will eventually isolate the leaf flap pocket. 21-Leaf fold retreat occupied by a 2nd instar larva on sassafras (Nashville, Tennessee, July 1986). 22-Fourth instar larva on sassafras in laboratory, initiating a leaf fold resting pad. 23-A completed leaf fold on sassafras occupied by 5th instar larva in the field (Nashville, Tennessee, July 1986).

tions, the weight of the leaf plus that of the larva causes the tip to droop below the base and petiole.) However, following a disturbance, the larva will resume adding silk to the pad in areas that it can reach without moving or disengaging its prolegs. The initial behavioral sequence is re-

peated whenever the larva returns from a feeding bout, resulting in a thorough reinforcement of the pad. The silk causes the leaf to bow upward slightly, resulting in elevation of the pad up to $\frac{1}{2}$ cm above the leaf surface at midrib (Scudder, 1889). Contraction of wetted silk may account

for some of the bowing, but studies on other Lepidoptera suggest that repeated addition of silk threads under slight tension may accomplish most of the work (Fitzgerald et al., 1991).

A larva may reuse the same resting leaf for up to 7 days before abandoning it. Abandonment of a resting site typically follows a molt, though it also may occur unpredictably within an instar.

Mature *P. glaucus* larvae may feed on a leaf 1 m or further from the resting leaf. Feeding occurs from the leaf edge, beginning at the leaf tip. On small leaves, the prolegs are used to clasp the petiole of the leaf, while the legs hold the leaf edge. On host plants with large leaves, a loose meshwork of silk laid onto the leaf surface is used to anchor the prolegs while the larva bends over the leaf edge, as do young larvae. When it has finished feeding, the larva crawls back down the petiole to the stem, then turns around and chews through the petiole to remove the partially eaten leaf before returning to its resting leaf (Fig. 19; Lederhouse, 1990).

P. troilus.—Young larvae of *P. troilus* exhibit more complex behavior than the species described above. They spin a silk pad as a resting site on the upper leaf surface, as do *P. glaucus* larvae, but they also coordinate their feeding and spinning behavior to create a shelter over the pad (Figs. 20–21).

The resting pad is formed at the start of a silk trail that leads to one or two feeding sites at the leaf margin. The pad is narrow and longer than the larva. In the initial stages of feeding, the larva produces a narrow and deep cut into the leaf (Fig. 20). The cut, or cuts, usually form a right angle with the end of the silk pad. Repeated trips along the trail allow the larva to reinforce its pad with silk under tension. Eventually, the pad forms the fold in the leaf flap, once it has been cut free by the larva's feeding activity.

The sequence of behavior that is followed depends partly on the location of the newly hatched larva on its host leaf, which determines where it will start spinning. Under most natural conditions, the larva aligns its silk pad along a major vein near the distal tip of the leaf. From this location, a single feeding cut begun from the proximal end of the pad will free a flap of leaf tissue (Fig. 21). If the silk pad is located at an interior site, either two feeding cuts, or a curved cut, will be used to free the leaf flap—or the larva may abandon the site and start a new pad elsewhere (Fig. 20). The silk threads that form the resting pad are responsible for folding the leaf flap, in the same way that the pad spun by mature larvae of *P. glaucus* bows its resting leaf.

Once a pocket has been created, the larva expands the cuts to isolate the leaf pocket from the remainder of the leaf. The larvae in Figs. 20 and 21 have just begun this



Fig. 24. Leaf fold retreat on red bay occupied by a young larva of *P. palamedes* (~6 mm length), molting from 2nd to 3rd instar. Collected in the field, Highlands Co., Florida (August 1985).

phase. Eventually, only a narrow strip attached to the fold under the silk pad will remain to connect the pocket with the rest of the leaf. A major leaf vein under the pad provides a secure attachment for the pocket. After this stage, the larva travels out of the pocket, towards the leaf base, to feed on other parts of the leaf.

This sequence of behaviors may be repeated on additional leaves before the larva reaches the fourth instar. At this stage, it undergoes a transformation to the mature color pattern similar to that of *P. glaucus*. Behavior also changes: mature larvae of *P. troilus* rest on the upper surface of a leaf that they do not feed upon. However, like the young larvae, they also use their silk pad to create a shelter.

Mature larvae spin a narrow, elongated, resting pad (~1 cm wide × 10 cm long). It is built up from a repeated series of densely spaced parallel threads, each about ½ cm long, deposited as though the larva were sewing a seam along the leaf midrib (Fig. 22). Silk threads are laid down perpendicular to the direction of travel, which constitutes

the long axis of the resting pad. As in the case of young larvae, successive reinforcement of the pad increases the amount of folding, eventually creating a pocket from the entire leaf (Fig. 23). Once the pocket is complete, the larva rests on the pad inside, with its head facing upward towards the leaf base.

Feeding behavior of a mature *P. troilus* larva is similar to that of *P. glaucus*, with the larva travelling some distance along a branch from its resting leaf before moving onto another leaf. The larva first spins a silk trail to reach the tip of the leaf on which it will begin feeding. The silk trail is laid down as a series of elongate figure eights along the major vein of the leaf, oriented in the direction of travel towards the tip. Prolegs remain anchored on the silk trail while the larva bends over the leaf edge to feed.

I observed feeding and resting behavior of larvae of *P. troilus* only on sassafras, which has relatively large, flexible, leaves. Behavior may differ on other hosts with much smaller or tougher leaves, such as spicebush (*Lindera benzoin* [L.] Blume).

P. palamedes.—Young larvae of *P. palamedes* create folded retreats similar to those of young *P. troilus* (Fig. 24). I observed young *P. palamedes* larvae only on the young leaves of their host, red bay. Once they have fully hardened, the older leaves of red bay are very tough; they could not be folded to create a shelter, and may be too tough for young larvae to feed upon.

Mature larvae rest on a silk pad spun on the upper surface of mature host leaves. The pad-spinning behavior is similar to that of *P. glaucus*. Unlike the silk pad of *P. troilus*, the pad of mature larvae of *P. palamedes* that I observed did not result in a folded leaf shelter. This may be due to the toughness of the host foliage. Mature larvae of *P. palamedes* leave the silk pad to feed on other leaves, as do larvae of *P. troilus* and *P. glaucus*.

DISCUSSION

LEAF-RESTING AND STEM-RESTING HABITS

The behavior and morphology of lepidopteran larvae represent a compromise between selection to maximize growth rate and selection to minimize mortality risk (Stamp and Wilkens, 1993). The most important consequence of variation in attachment behavior is variation in the microhabitats occupied by larvae on their host plants. Growth rate and mortality risk are both potentially affected by choice of microhabitat.

Microhabitat can influence the thermal environment experienced by a larva, which in turn may affect its growth rate. For species that occur in marginal environments, small differences in growth rate can have major effects on fitness (Ayres and Scriber, 1994). However, most swallow-

tail species occur in the tropics or subtropics, where the long favorable season should minimize direct effects of growth rate on fitness (Scriber, 1995). The consequences of variation in growth rate among microhabitats can be outweighed by variation in mortality rates.

Mortality from predators and parasitoids is therefore likely to be the major process determining the evolution of attachment behavior and external morphology. For papilionine larvae, low density and crypsis are the primary defenses (Scudder, 1889; Lederhouse, 1990; Stamp and Wilkens, 1993; Takagi et al., 1995). A basic element of crypsis in all larval stages is the alternation of brief feeding bouts with longer quiescent periods away from the feeding site. This behavior reduces risk of discovery by enemies that use leaf damage as a searching cue (Heinrich, 1993).

The separation of feeding and resting sites sets the conditions for other elements of crypsis, including color pattern, movement, and foraging behavior. To escape visually searching predators during the resting phase of the activity cycle, larvae must be able to match their backgrounds or masquerade as inedible objects (Heinrich, 1993; Stamp and Wilkens, 1993). The effectiveness of different types of visual crypsis is determined primarily by larval size, and changes greatly as larvae develop (Reavey, 1993).

Young larvae of different species tend to be more similar in appearance and behavior than are older larvae. First and second instar larvae of papilionine species typically have a mottled brown or black color pattern, and resemble bits of debris or feces lying on the upper surface of host plant leaves (Minno and Emmel, 1992a; examples in Tyler et al., 1994).

The similarity among young larvae can be explained by the general consequences of being small relative to the size of a leaf. Small larvae have limited mobility relative to larger larvae, and cannot move far from the feeding site. Small larvae are also more vulnerable than large larvae to attack by small predatory arthropods (Watanabe, 1981; Feeny et al., 1985). These predators walk along stems and branches as they search for prey, and will be more likely to encounter a larva there than on a leaf (Reavey, 1993; Stamp and Wilkens, 1993). Conversely, a small larva is less likely to attract attention from large-bodied predators, such as birds or wasps (Heinrich, 1993). A leaf of any host plant will acquire small bits of darkly colored debris or droppings, but larger pieces will be both rarer and more quickly removed by wind or rain (Minno and Emmel, 1992a; R. Hagen, unpublished notes).

In addition, a small larva can anchor itself to a leaf by spinning a few silk threads, as does *P. polyxenes* on parsley. Larvae that feed on host plants with smooth leaves, or which are more exposed to wind, may benefit from the additional support provided by a silk pad. Bell (1912a,b)

noted that silk pads are used by young larvae of several Indian species that feed on trees.

Penultimate (fourth) and final (fifth) instar larvae confront a different set of conditions for attachment. Typical papilionine larvae grow from approximately 1 mg at hatching to over 1,000 mg at pupation; their length increases from 5 to 50 mm (Ayres and Scriber, 1994; R. Hagen, unpublished notes). Increased mass requires greater force for the larva to remain attached to the host plant. A large larva must therefore spin a large silk pad in order to remain anchored to the leaf. Gripping prolegs will enhance a larva's ability to hold onto the silk pad, by allowing crochets to engage the pad over a larger area. Continued leaf-resting also requires a host plant with relatively tough leaves. Larvae of the *machaon* species group, which feed on herbaceous host plants, may not have the option of remaining on a leaf throughout development.

As an alternative, mature larvae may shift their resting sites to stems, branches, or petioles. The clasping type of proleg allows force to be applied strongly to a stem or twig, without the need to spin a silk pad. Species with clasping prolegs thus have the advantage of greater flexibility in choosing a resting site on the host plant. Unlike small larvae, a large larva on the stem can defend itself against small predators, and may be at less risk of attack even if the risk of encounter is increased.

Leaf-resting and stem-resting can be seen as alternative strategies for mature larvae. Traits of the mature larvae of North American species of *Papilio*, summarized in Table 1, are correlated in a way that suggests they represent distinct adaptive syndromes (suites of functionally related characters). Mature larvae of *P. glaucus* and *P. troilus* possess two rows of proleg crochets, indicating a gripping proleg, and they spin a silk pad for support. Their "green" color pattern allows them to match the visual background created by a leaf surface. In contrast, mature larvae of *P. cresphontes* and *P. polyxenes* possess one row of crochets, indicating a clasping proleg, which enables them to rest on twigs, petioles, or stems within the host plant canopy. The striped or blotchy "non-green" color pattern allows these larvae to match the more complex visual background created by the interior of the plant canopy. Minno and Emmel (1992b) further suggest that the orientation of false eyespots on these larvae is correlated with the direction from which wandering predators are most likely to approach: anteriorly directed eyespots occur on larvae occupying leaf surfaces, and posteriorly directed eyespots on larvae that occupy stems.

Assessment of the generality of these adaptive syndromes requires information on other species of papilionines. Traits of the larva of *P. anchisiades* can be interpreted as a variation on the stem-resting strategy. All

larval stages are gregarious; fourth and fifth instar larvae aggregate in small groups on the trunk of the host tree (Young et al., 1986; Tyler et al., 1994). The intermediate arrangement of crochets on mature larvae (Fig. 12) may improve attachment to the relatively flat surface of a tree trunk where full clasping prolegs may function poorly. Mature larvae of *P. anchisiades* do not appear to spin a silk pad for attachment (Young, 1986). Forbes (1960: 104) described the 2-row crochet arrangement as characteristic of the *anchisiades* species group. Of the 14 included species, only *P. hyppason* is reported to be solitary (Hancock, 1983; Tyler et al. [1994] suggest that it may not belong to this species group.)

Mature larvae of 3 Asian species (*P. [Princeps] xuthus* L., *P. [Princeps] protenor* Cramer, and *P. [Princeps] helenus* L.) use a silk pad for resting, but the resting site differs among hosts. On *Citrus* spp., which have relatively large leaves, larvae use the upper leaf surfaces; on *Zanthoxylum* spp., which have compound leaves, larvae may use branches or stems, as well as petioles (M. Watanabe, personal communication). Mature larvae of many species included in *Princeps* are green, with a contrasting dorsal metathoracic band that terminates in lateral eyespots ("part-green" color pattern: Table 1). A similar color pattern occurs in species of the subgenus *Pyrrhosticta* (Table 1). The functional significance of the part-green pattern is uncertain. Mature larvae with a part-green pattern may be matching an intermediate visual background; one possibility is that they rest on partially shaded leaves or leafy petioles.

Unfortunately, few published descriptions of papilionine larvae include information on arrangement of crochets, and illustrations rarely show ventral characters. The formal terminology of lepidopteran crochets can be a source of confusion as well. In the only recent description I have found, the arrangement of crochets in mature larvae of *P. homerus* is given as "uniserial, triordinal transverse bands" (Turner, 1991: 264). It is likely that "transverse bands" was used in error, because butterfly larvae have crochets in longitudinal rows (Hinton, 1952). According to Stehr (1987: 294), the "transverse bands" arrangement is the same as a 90-degree rotation of the 2-row pattern, "mesoserries plus lateroserries" (Figs. 13–15). In Table 1, the crochet arrangement of *P. homerus* is listed as a 2-row pattern.

Published information on the behavior of papilionine larvae is also limited. Even when larvae can be obtained for study, their natural behavior may be obscured by artifacts of rearing in confinement. Because behavioral observation is seldom a goal of rearing efforts, larvae are usually reared in small containers and fed excised foliage that is frequently replaced to maintain its freshness. These con-

ditions may promote high survival at the expense of natural behavior. For example, young larvae of *P. troilus* and *P. palamedes* require several days to form leaf-fold retreats. If foliage in the container is changed daily, the larvae will be disturbed before they have completed the full behavioral sequence on any leaf. Often, larvae that construct a silk pad for attachment will do so on the container's walls (as in Fig. 8). In addition, mature larvae reared in a small container will often feed on their resting leaf when they re-encounter it after leaving their silk pad; the normal separation of feeding and resting sites is lost under these conditions.

EVOLUTION OF LARVAL BEHAVIOR AND MORPHOLOGY

A robust phylogeny is an essential prerequisite for drawing evolutionary conclusions about an adaptation (Coddington, 1994). At present, this is not available for Papilionini, though there is a general consensus about higher level relationships within the family Papilionidae (Miller, 1987). Although Hancock (1983) based his classification of Papilionini on cladistic analysis of larval and adult characters, many of the branches were poorly supported. Tyler et al. (1994) present detailed character matrices and provide critiques of earlier analyses.

Both leaf-resting (presumably, gripping prolegs) and stem-resting (presumably, clasping prolegs) occur in other tribes of Papilioninae. Larvae of the Troidini, identified as the sister taxon to Papilionini by Miller (1987), have clasping prolegs. Within the Graphiini, larvae that rest on upper leaf surfaces occur in several genera (Bell, 1912b; Tyler et al., 1994). Data on proleg morphology are lacking for the Graphiini. Information on larval morphology and behavior of *Meandrusa* also would be valuable for determining whether leaf-resting or stem-resting is ancestral for *Papilio*.

In their discussions of variation in prolegs, Hinton (1952) and Forbes (1951, 1958, 1960) simply assumed that the gripping proleg of mature papilionines is homologous with the primitive lepidopteran form. This would imply that the gripping proleg represents the ancestral condition for papilionines. Alternatively, it could be assumed that spinning a large silk pad is a derived behavioral character—which would imply that the clasping proleg is ancestral. The latter hypothesis appears more likely, based on consideration of how variation in behavior and proleg morphology might originate.

Variation in proleg morphology among species of Papilionini could be generated easily by heterochrony during larval development (Alberch et al., 1979). The clasping proleg of mature butterfly larvae develops from the gripping proleg by reduction of the lateroseries crochets, coupled with enlargement of the mesoseries crochets.

Hinton (1952) describes this as a gradual process that occurs progressively with each larval molt. However, in *P. polyxenes*, the change occurs primarily during the molt from the third to the fourth larval instar. Retention of gripping prolegs by mature larvae could be achieved through paedomorphosis: delaying the start of the process or by sufficiently slowing it. An intermediate crochet arrangement, such as that of mature larvae of *P. anchisiades* (Fig. 12), could result from less extreme paedomorphosis. A comparison of proleg ontogeny in different papilionine taxa would provide a critical test of this scenario.

For leaf-resting larvae, the gripping proleg functions together with the silk pad as the adaptation for attachment to the host plant. The behavior of spinning a large silk pad for resting could be derived from that used by many species to spin a silk pad for attachment during larval or pupal molts. The same behavioral sequence could be expressed in both cases; to make a resting pad, the behavior needs to be initiated at times other than molting by a larva that returns to the pad between feeding bouts.

The more elaborate behavior of *P. troilus* could be derived from behavior similar to that of *P. glaucus*. The narrow feeding cut made by young larvae and the narrow, linear resting pad constructed by mature larvae can both be generated by restricting the arc through which the larva sweeps its head as it feeds and spins silk. If the head makes a wide arc during feeding, the result is a wide, shallow strip removed from the leaf margin. If the head makes a narrow arc, more sweeps must be made to consume the same total leaf area, resulting in a narrow, deep cut. If a wide arc is made while spinning silk, the result will be a broad pad in which the silk threads are aligned poorly and have relatively little cumulative effect on the leaf. If a narrow arc is made, the result will be a narrow pad, in which the silk threads are aligned perpendicular to the axis of the larva's body and can exert effective force on the leaf (Fitzgerald et al., 1991).

It is uncertain whether more silk is required to create a leaf fold. Regardless, the spinning behavior necessary to create a folded pocket for resting will be effective only on a host plant with leaves that are sufficiently large and flexible. The absence of leaf-folding by mature larvae of *P. palamedes* could result from either tougher host plant leaves, which don't fold, or from a difference in the spinning behavior of the larvae themselves. Additional observations on mature larvae of the *troilus* group would be valuable.

Larval morphology and behavior are similar within species groups and among related groups (Table 1, and unpublished notes). Diversification of larval habit is slow among papilionines, relative to rates of speciation. This conservatism mirrors that of host plant associations within the family, which have been the subject of intensive study

(e.g., Forbes, 1958; Munroe, 1961; Feeny, 1991; Scriber et al., 1991; Tyler et al., 1994; Berenbaum, 1995). However, host plant association and larval attachment do not appear to be correlated across species groups. For example, Asian species included in *Princeps* (e.g., *P. helenus*) and American species included in *Heraclides* (e.g., *P. cresphontes*) both use Rutaceae as host plants: *Heraclides* species are stem-resting, whereas *Princeps* spp. appear to be leaf-resting (Table 1).

However, the potential for relatively rapid shifts in some aspects of attachment behavior is suggested by the polymorphic African species *P. [Princeps] demodocus* Esper. One form of the mature larva has a green background color, with a dorsal metathoracic band terminating in lateral eyespots, and feeds on *Citrus* leaves; the other form has a blotchy background pattern, lacks eyespots, and feeds on foliage of Apiaceae (Clarke et al., 1963). Clarke and co-workers demonstrated that the two forms are inherited as Mendelian traits, with separate loci controlling host plant selection and color pattern. Clarke et al. (1963) did not discuss whether the crochet arrangement or larval behaviors also differ between forms of *P. demodocus*.

The most interesting questions concern the integration of these separate elements of larval morphology and behavior. One example of a coordinated shift in behavior and external morphology, mediated by diet, has been observed in a geometrid larva (Greene, 1989). The diversity among papilionine swallowtails offers an opportunity to dissect the evolutionary history of these important larval adaptations.

LITERATURE CITED

- Alberch, P., S. J. Gould, G. F. Oster, and D. B. Wake. 1979. Size and shape in ontogeny and phylogeny. *Paleobiology* 5: 296–317.
- Ayres, M. P., and J. M. Scriber. 1994. Local adaptation to regional climates in *Papilio canadensis* (Lepidoptera: Papilionidae). *Ecological Monographs* 64: 465–482.
- Bell, T. R. 1912a. The common butterflies of the plains of India. Part X. *Journal of the Bombay Natural History Society* 21: 517–544.
- Bell, T. R. 1912b. The common butterflies of the plains of India. Part XI. *Journal of the Bombay Natural History Society* 21: 740–766.
- Berenbaum, M. 1995. Chemistry and oligophagy in the Papilionidae. Pp. 27–38, in J. M. Scriber, Y. Tsubaki, and R. C. Lederhouse (eds.), *Swallowtail Butterflies: Their Ecology and Evolutionary Biology*. Gainesville, Florida: Scientific Publishers.
- Carter, M., and P. Feeny. 1985. Techniques for maintaining a culture of the black swallowtail butterfly, *Papilio polyxenes asterius* Stoll (Papilionidae). *Journal of the Lepidopterist's Society* 39: 125–133.
- Caterino, M. S., and F. A. H. Sperling. 1999. *Papilio* phylogeny based on mitochondrial Cytochrome Oxidase I and II genes. *Molecular Phylogenetics and Evolution* 11: 122–137.
- Clarke, C. A., C. G. C. Dickson, and P. M. Sheppard. 1963. Larval color pattern in *Papilio demodocus*. *Evolution* 17: 130–137.
- Coddington, J. A. 1994. The roles of homology and convergence in studies of adaptation. Pp. 53–78, in P. Eggleton and R. I. Vane-Wright (eds.), *Phylogenetics and Ecology* (Linnean Society Symposium Series 17). San Diego: Academic Press.
- Feeny, P. 1991. Chemical constraints on the evolution of swallowtail butterflies. Pp. 315–340, in P. W. Price, T. M. Lewinsohn, G. Wilson Fernandes, and W. W. Benson (eds.), *Plant-Animal Interactions: Evolutionary Ecology in Tropical and Temperate Regions*. New York: John Wiley.
- Feeny, P., W. S. Blau, and P. M. Kareiva. 1985. Larval growth and survivorship of the black swallowtail butterfly in central New York. *Ecological Monographs* 55: 167–187.
- Fitzgerald, T. D., K. L. Clark, R. Vanderpool, and C. Phillips. 1991. Leaf shelter-building caterpillars harness forces generated by axial retraction of stretched and wetted silk. *Journal of Insect Behavior* 4: 21–32.
- Forbes, W. T. M. 1951. Footnote on *Papilio*. *Lepidopterist's News* 5: 16.
- Forbes, W. T. M. 1958. Caterpillars as botanists. *Proceedings of the 10th International Congress of Entomology* (1956) 1: 313–317.
- Forbes, W. T. M. 1960. *Lepidoptera of New York and neighboring states*. Part IV. Cornell University Agricultural Experiment Station Memoir 371: 1–188.
- Greene, E. 1989. A diet-induced developmental polymorphism in a caterpillar. *Science* 243: 643–646.
- Hagen, R. H. 1986. The Evolution of Host Plant Use by the Tiger Swallowtail Butterfly, *Papilio glaucus*. Ph.D. Dissertation, Cornell University, Ithaca, New York.
- Hagen, R. H., and R. C. Lederhouse. 1985. Polymodal emergence of the tiger swallowtail, *Papilio glaucus* (Lepidoptera: Papilionidae): source of a false second generation in central New York State. *Ecological Entomology* 10: 19–28.
- Hagen, R. H., and J. M. Scriber. 1991. Systematics of the *Papilio glaucus* and *P. troilus* species groups (Lepidoptera: Papilionidae): inferences from allozymes. *Annals of the Entomological Society of America* 84: 380–395.
- Hagen, R. H., and J. M. Scriber. 1995. Sex chromosomes and speciation in tiger swallowtails. Pp. 211–227, in J. M. Scriber, Y. Tsubaki, and R. C. Lederhouse (eds.), *Swallowtail Butterflies: Their Ecology and Evolutionary Biology*. Gainesville, Florida: Scientific Publishers.
- Hancock, D. L. 1983. Classification of the Papilionidae (Lepidoptera): A phylogenetic approach. *Smithersia* 2: 1–48.
- Heinrich, B. 1993. How avian predators constrain caterpillar foraging. Pp. 224–247, in N. E. Stamp and T. M. Casey (eds.), *Caterpillars: Ecological and Evolutionary Constraints on Foraging*. New York: Chapman and Hall.
- Hinton, H. E. 1952. The structure of the larval prolegs of the Lepidoptera and their value in the classification of the major groups. *Lepidopterist's News* 6: 1–6.
- Igarashi, S. 1979. *Papilionidae and Their Early Stages*. Vols. 1 and 2. Japan: Published by the author. [in Japanese]
- Lederhouse, R. C. 1990. Avoiding the hunt: primary defenses of lepidopteran caterpillars. Pp. 175–189, in D. L. Evans and J. O. Schmidt (eds.), *Insect Defenses*. Albany, New York: SUNY Press.
- Miller, J. S. 1987. Phylogenetic studies in the Papilioninae (Lepidoptera: Papilionidae). *Bulletin of the American Museum of Natural History* 186: 365–512.
- Minno, M. C., and T. C. Emmel. 1992a. Larval protective coloration in swallowtails from the Florida Keys (Lepidoptera: Papilionidae). *Tropical Lepidoptera* 3: 47–49.
- Minno, M. C., and T. C. Emmel. 1992b. Caudal false face patterns on the larvae of Florida swallowtails (Lepidoptera: Papilionidae). *Tropical Lepidoptera* 3: 51–52.
- Munroe, E. 1961. The classification of the Papilionidae (Lepidoptera). *Canadian Entomologist, Supplement* 17: 1–51.
- Opler, P. A. 1992. *A Field Guide to Eastern Butterflies*. New York: Houghton Mifflin.
- Reavey, D. 1993. Why body size matters to caterpillars. Pp. 248–279, in

- N. E. Stamp and T. M. Casey (eds.), *Caterpillars: Ecological and Evolutionary Constraints on Foraging*. New York: Chapman and Hall.
- Reed, R. D., and F. A. H. Sperling. 1999. Interaction of process partitions in phylogenetic analysis: an example from the swallowtail butterfly genus *Papilio*. *Molecular Biology and Evolution* 16: 286–297.
- Scriber, J. M. 1995. Overview of swallowtail butterflies: Taxonomic and distributional latitude. Pp. 3–8, in J. M. Scriber, Y. Tsubaki, and R. C. Lederhouse (eds.), *Swallowtail Butterflies: Their Ecology and Evolutionary Biology*. Gainesville, Florida: Scientific Publishers.
- Scriber, J. M., R. C. Lederhouse, and K. Brown. 1990 [1991]. Hybridization of Brazilian *Papilio* (*Pyrrhosticta*) (Section V) with the North American *Papilio* (*Pterourus*) (Section III). *Journal of Research on the Lepidoptera* 29: 21–22.
- Scriber, J. M., R. C. Lederhouse, and R. H. Hagen. 1991. Foodplants and evolution within *Papilio glaucus* and *P. troilus* species groups (Lepidoptera: Papilionidae). Pp. 341–373, in P. W. Price, T. M. Lewinsohn, G. Wilson Fernandes, and W. W. Benson (eds.), *Plant-Animal Interactions: Evolutionary Ecology in Tropical and Temperate Regions*. New York: John Wiley.
- Scudder, S. H. 1889. *The Butterflies of the Eastern United States and Canada*. Vol. 2. Cambridge, Massachusetts: Published by the author.
- Southwood, T. R. E. 1973. The insect/plant relationship—an evolutionary perspective. Pp. 3–30, in H. F. van Emden (ed.), *Insect/Plant Relationships*. Oxford: Blackwell.
- Stamp, N. E., and R. T. Wilkens. 1993. On the cryptic side of life: being unapparent to enemies and the consequences for foraging and growth of caterpillars. Pp. 283–330, in N. E. Stamp and T. M. Casey (eds.), *Caterpillars: Ecological and Evolutionary Constraints on Foraging*. New York: Chapman and Hall.
- Stehr, F. W. 1987. Order Lepidoptera. Pp. 288–305, in F. W. Stehr (ed.), *Immature Insects*. Vol. 1. Dubuque, Iowa: Kendall/Hunt Publishing Co.
- Takagi, M., Y. Hirose, and M. Yamasaki. 1995. Antipredator defense in *Papilio* larvae: effective or not? Pp. 85–92, in J. M. Scriber, Y. Tsubaki, and R. C. Lederhouse (eds.), *Swallowtail Butterflies: Their Ecology and Evolutionary Biology*. Gainesville, Florida: Scientific Publishers.
- Talbot, G. 1939. *The Fauna of British India, Including Ceylon and Burma: Butterflies*. Vol. 1. London: Taylor and Francis.
- Turner, T. W. 1991. *Papilio homerus* (Papilionidae) in Jamaica, West Indies: field observations and description of immature stages. *Journal of the Lepidopterist's Society* 45: 259–271.
- Tyler, H. A., K. S. Brown, Jr., and K. H. Wilson. 1994. *Swallowtail Butterflies of the Americas: A Study in Biological Dynamics, Ecological Diversity, Biosystematics, and Conservation*. Gainesville, Florida: Scientific Publishers.
- van Son, G. 1949. The butterflies of Southern Africa. Part I. Papilionidae and Pieridae. *Transvaal Museum Memoirs* 3: 1–237.
- Watanabe, M. 1981. Population dynamics of the swallowtail butterfly, *Papilio xuthus* L., in a deforested area. *Researches on Population Ecology* 23: 74–93.
- Wenzel, J. W. 1993. Application of the biogenetic law to behavioral ontogeny: a test using nest architecture in paper wasps. *Journal of Evolutionary Biology* 6: 229–247.
- Young, A. M., M. S. Blum, H. M. Fales, and Z. Bian. 1986. Natural history and ecological chemistry of the neotropical butterfly, *Papilio anchisiades* (Papilionidae). *Journal of the Lepidopterist's Society* 40: 36–53.

~~Now~~

DATE DUE

UNIVER	MUSEUM
3. Maintenance Armstrong	phy and Barry L. 6-7.
7. A Diapsid F 1-74. 18 F	bert R. Reisz. Pp.
8. The Ecolog David Wil	of fauna. By Larry BN 0-89338-018-0.
13. Geographic America.	as <i>arctos</i>) in North
15. Spring Gee ISBN 0-893	September 1984.
18. A Checklist seph T. Co	e D. Potts and Jo- 038-5.
19. The Compl D. Siegel- ISBN 0-89	s. By E. O. Wiley, 1991. Pp. 1-158.
DEMCO INC 38-2931	
22. Guide to the Frogs of the Iquitos Region, Amazonian Peru. By Lily O. Rodríguez and William E. Duellman. Pp. 1-80 + 12 color plates. December 1994. ISBN 0-89338-047-4.	
23. Frogs of the Genus <i>Eleutherodactylus</i> (Leptodactylidae) in Western Ecuador. By John D. Lynch and William E. Duellman. Pp. iv + 236 + 12 color plates. 21 February 1997. ISBN 0-89338-054-7.	

See inside front cover for instructions for ordering.

QL463 .E58 1999
Entomological contributions in memo
Harvard MCZ Library BOH7395



3 2044 062 473 806

Byron Alexander was a biologist whose interests extended far beyond his primary area of research in systematics and behavior of Hymenoptera. At the time of his tragically premature death on 30 November 1996, Byron was Associate Professor of Entomology and of Systematics and Ecology, and a curator in the Snow Entomological Collection of the Natural History Museum at the University of Kansas. During his brief professional career, Byron published extensively. He had also earned the friendship and respect of associates from around the world. This volume of entomological contributions resulted from a desire among Byron's students and colleagues to honor his memory.

Thirty-two papers are included in this collection. The majority focus on Hymenoptera, especially bees, but Coleoptera, Lepidoptera, Orthoptera, Mecoptera, and Acari are also represented. Subjects include insect systematics and behavior, along with morphology, life history, genetics, evolution, and ecology.