

## **Whole Body Vibration Alters Proprioception in the Trunk**

Lu Li, M.S.<sup>1</sup>

Farhana Lamis<sup>1</sup>

Sara E. Wilson, Ph.D.<sup>1</sup>

<sup>1</sup>Department of Mechanical Engineering, University of Kansas, Lawrence, KS

---

Please address all correspondence to: S.E. Wilson, Ph.D.

Human Motion Control Laboratory

Department of Mechanical Engineering,

University of Kansas

1530 W. 15<sup>th</sup> Street, Lawrence, KS 66045

Phone: (785) 864-2103; FAX: (785) 864-5254

[sewilson@ku.edu](mailto:sewilson@ku.edu)

**Abstract:**

Occupational whole body vibration has long been associated with low back injuries. However, the mechanism of these injuries is not well understood. In this paper, the effect of whole body vibration on proprioception and dynamic stability was examined. Subjects exposed to 20 minutes of vertical, seated, whole body vibration were found to have a 1.58 fold increase in position sense errors after vibration relative to controls exposed to 20 minutes of the same seated posture without vibration exposure. To understand the potential effect of a sensory loss on dynamic low back stability a lumped parameter model of the trunk and neuromotor response was created. Using this model, an increase in the threshold of the sensory system was predicted to increase trunk flexion and delay neuromotor response with a sudden, unexpected perturbation. These predictions were demonstrated in a second experiment where subjects exhibited both an 11.9% increase in trunk flexion and an 11.2% increase in time to peak paraspinal muscle response (measured using integrated electromyographic activity) after exposure to 20 minutes of vertical, seated, whole body vibration.

**Keywords:** Vibration, Proprioception, Lumbar Spine, Stability

**Relevance to Industry:**

For workers exposed to WBV, this research suggests a loss in the ability to sense and control lumbar posture may occur. After exposure, unexpected perturbations during manual materials handling could lead to injury. Reducing vibration exposure or a break between exposure and manual materials handling could be used to reduce this risk.

## **Introduction**

Whole body vibration (WBV) exposure has long been identified as an important risk factor for musculoskeletal injuries in industrial workers (Frymoyer et al., 1983).

WBV has been associated with a higher incidence of low back disorders in a number of occupations including pilot, truck driver, and heavy equipment operator (Bongers et al., 1990, Fishbein and Salter, 1950, Magnusson et al., 1996, Mansfield and Marshall, 2001, Pope and Hansson, 1992). Exposure to WBV has been demonstrated to increase risk of low back disorders by a factor of 1.2 to 39.5 (Bernard, 1997).

The transmissibility of WBV has been studied by a number of investigators (Griffin and Brett, 1997, Kitazaki and Griffin, 1998, Mansfield and Griffin, 2000, Pope et al., 1998, Pope et al., 1999). These studies have demonstrated a resonance of the seated person to axial seat pan vibrations of 4-6 Hz. While transmissibility has been studied thoroughly, the mechanism by which such vibration leads to low back injury has yet to be identified. Cyclic muscular activity in the muscles of the low back has been observed during exposure to 3-10 Hz vertical, seat pan vibrations (Bluthner et al., 2001, Bluthner et al., 2002, Pope et al., 1998, Seroussi et al., 1989, Wilder et al., 1996). Investigators have suggested that such muscular activity is the result of activation of reflex mechanisms (Bluthner et al., 2001, Bluthner et al., 2002). Such stimulation of sensory and neuromotor systems in WBV may contribute to possible injury mechanisms.

Direct muscle vibration has been shown to have a number of interesting effects on the proprioceptive system. Muscle and tendon vibration in the extremities has been shown to result in altered proprioception and kinesthetic illusions (Cordo et al., 1995, Roll and Vedel, 1982). Brumagne et al. (2000) demonstrated vibration-induced changes

in proprioception in the low back during exposure to direct paraspinal muscle vibration. It has also been shown, in experiments with a variety of muscles in the extremities, that increased errors in proprioception due to muscle vibration can remain after the vibration exposure, possibly due to neuromotor habituation or adaptation (Feldman and Latash, 1982, Shinohara, 2005, Wierzbicka et al., 1998). Both of these effects have been attributed to muscle spindle organ sensitivity to vibration (Cordo et al., 1995, Feldman and Latash, 1982, Roll and Vedel, 1982, Shinohara, 2005, Wierzbicka et al., 1998). Although such effects have been demonstrated for vibration applied directly to the muscle or its associated tendon, the effects of WBV on proprioception have not been examined.

Based on these findings for direct muscle vibration, it is possible that WBV could stimulate the proprioceptive system leading to increased errors in proprioception. Such a change in the neuromotor system could alter dynamic spine stabilization. In this current study, the theory that WBV alters proprioception and dynamic stabilization was examined. The primary hypothesis was that WBV would increase errors in the ability of a subject to sense low back posture relative to unexposed control subjects. Using a lumped parameter model of the trunk and neuromotor system, the effect of such an increased error on the dynamic stabilization of the trunk was examined. From this model, it was hypothesized that conditions such as WBV that increase errors in the ability to sense low back posture would correspond to increases in neuromotor response delay and trunk flexion in response to a sudden load.

## **Experiment 1 - Methods**

### **Participants:**

Seventeen healthy subjects (10 female, 7 male, aged 22-33 [ $27.5 \pm 5.5$ ] years,  $168 \pm 8$  m,  $64 \pm 13$  kg) participated in the study as exposure subjects and sixteen healthy subjects (6 female, 10 male, aged 21-36 [ $25.3 \pm 3.9$ ] years,  $171 \pm 7$  m,  $71 \pm 13$  kg) participated as control subjects. This study was approved by the Human Subjects Committee of the University of Kansas. Before participation, informed consent was obtained from all participants. All of the participants reported no instance of low back pain or musculoskeletal disorder limiting normal torso flexion within the last year.

### **Instrumentation:**

A 3-D electromagnetic motion analysis system (Motion Star, Ascension Technology, Burlington, VT) was used to assess torso motion. This system measures both position and orientation of each sensor with a resolution of 0.08 cm and 0.1 degrees and an RMS accuracy of 0.76 cm and 0.5 degrees. Three electromagnetic sensors were placed on the skin over the manubrium and the T-10 and S1 spinous processes using double-sided tape. Data from these sensors were collected at 40 Hz. Using the position of the T10 and S1 sensors, trunk flexion angle was determined as the angle between a line connecting these sensors and vertical (defined as the z-axis of the leveled transmitter of the electromagnetic system). The difference in angular orientation between the T10 and S1 sensors in the anterior-posterior plane was defined as the lumbar curvature. The manubrium marker allowed detection of trunk rotation and asymmetry of motion. This configuration is consistent with previous literature on lumbar position sense and lumbar-

pelvic coordination (Gade and Wilson, 2003, Granata and Sanford, 2000, Wilson and Granata, 2003).

Procedure:

The experiment consisted of subjects performing position sense measures before and after either exposure to WBV for 20 minutes (exposure subjects) or quiet sitting in a similar posture for 20 minutes (control subjects). The position sense measures collected were based on a previously described position sense protocol (Wilson and Granata, 2003). The position sense protocol used an active-active paradigm and consisted of 3 training trials followed by alternation of assessment and training trials for a total of 3 assessment trials. Before starting the first training trial, the target lumbar curvature was determined as an average value of the maximum and minimum possible lumbar curvatures a subject could obtain while maintaining an upright (0 degree) trunk flexion. During training trials, the subjects were first instructed to assume 0 degrees of torso flexion and then match his/her target lumbar curvature while both the torso flexion and the lumbar curvature were displayed on a computer screen. During assessment trials, the biofeedback of the lumbar curvature was removed and the subjects were asked to reproduce the target curvature from memory. In between trials, the subjects were asked to flex their trunk to approximately 30 degrees to prevent holding of a lumbar posture. For each trial, once the subject thought he or she had obtained the target lumbar curvature, data were collected for 5 seconds. The absolute position sense error was calculated as the absolute value of the difference between the lumbar curvature the

subject assumed in assessment trials and the corresponding target curvature used in training. This measure allows assessment of the magnitude of error.

The position sense protocol was performed at two different time points: at the beginning of the experiment and after either exposure to 20 minutes of WBV or quiet sitting for 20 minutes. During the vibration exposure, subjects were asked to sit on an unpadded seat without a backrest. A shaker table (Ling, Anaheim, CA) applied a 5 Hz,  $0.223 \text{ m/s}^2$  RMS WBV to an unpadded seat in the vertical (z-axis) direction for 20 minutes. Throughout the WBV period, subjects placed their hands and feet on stable platforms adjusted to the subject's height. Subjects were told to assume a comfortable and relaxed sitting posture.

#### Data Analysis:

To normalize the position sense error for each subject, absolute position sense error after exposure was divided by the average absolute position sense error before exposure to get the position sense error ratio for each subject. A two-tailed, student t-test was performed on the position sense error ratio between the two populations with significance set at  $p=0.05$ .

### **Experiment 1 - Results**

For the control population, the position sense error ratio was  $1.00 \pm 0.63$  (deg/deg) with no significant difference observed between genders (Figure 1). A position sense error ratio of one suggests that on average, the position sense error after quiet sitting for 20 minutes was equal to that prior to quiet sitting. For the vibration exposure population,

the position sense error ratio was  $1.58 \pm 0.92$  (deg/deg) with no significant difference observed between genders. This position sense error ratio suggests that the average subject increased their position sense error 1.58 fold after exposure to 5 Hz, vertical WBV for 20 minutes. Comparing these two populations, a two-tailed student t-test determined that this increase in position sense error ratio after exposure was statistically significant ( $p < 0.05$ ).

### **Model**

Observing the increase in position sense error with exposure to WBV, one might ask how such an increase in this static measure might lead to low back injury. Position sense error is an indirect measure of the sense of lumbar posture or lumbar proprioception. This sense of lumbar posture can arise from a number of sensory elements including the muscle spindle organs of the trunk musculature, sensory elements in the passive soft tissues (such as the ligaments of the spine), and other sensory structures such as the vestibular system (Brumagne et al., 1999, Latash, 1998, Solomonow, 2004). The ability to sense joint motion is a critical element in a number of reflex and voluntary responses to joint perturbations such as the stretch reflex. In the stretch reflex, activation of the Ia afferents from the muscle spindle organs can induce contraction of the same muscle (Latash, 1998, Shinohara, 2005). Such reflex and voluntary response loops are critical to the response to sudden, unexpected perturbations. The ability to respond to sudden perturbations, therefore, could be modulated by changes in sensory ability.



To examine the potential effect of sensory deficits on low back stability, a model of trunk dynamics was created (Figure 2). In this model, the trunk was modeled as a simple inverted pendulum:

$$I\ddot{\theta} + B\dot{\theta} + K\theta - mgl \sin \theta = M_p \quad \text{eq. 1}$$

This model was linearized to create the transfer function:

$$\frac{\theta(s)}{M_p(s)} = \frac{1}{Is^2 + Bs + (K - mgl)} \quad \text{eq. 2}$$

Torso inertia and torso geometry were estimated using anthropometric data from Winter (1990). For this analysis, a 78 kg, 1.755 m male was used. The rotational inertia of the head, arms and trunk (HAT) (I) was estimated as 12.47 kgm<sup>2</sup>, the HAT mass (m) as 52.9 kg, and the height of the center of mass (l) as 0.381 m. The damping constant (B) was calculated based on maintaining a damping ratio ( $\zeta$ ) of approximately 0.2 for the combined intrinsic trunk stiffness and neuromotor response gain:

$$B = 2\zeta\sqrt{(K - mgl + G)I} \quad \text{eq. 3}$$

Similar simple models of trunk dynamics have been shown to be effective in modeling sudden loading dynamics in the trunk (Cholewicki et al., 1999, Cholewicki et al., 2000).

The neuromotor response to sudden loading was lumped into one proportional response modulated by three components: neuromotor gain, time delay and detection threshold. A time delay (Td) of 70 ms was included to account for conduction delays in the neuromotor system. The detection threshold (Th) was varied from 0 to 5 degrees to model increases in position sense error and losses in sensory ability.

The total trunk stiffness could be estimated as the sum of the intrinsic trunk stiffness due to passive tissue stiffness and preparatory muscle activation and neuromotor

gain. Cholewicki et al. (2000) reported trunk stiffnesses of  $1253 \pm 760$  Nm/rad ( $21.88 \pm 13.26$  Nm/deg). Moorhouse and Granata (2006) reported that 42% of the effective trunk stiffness comes from neuromotor gain. Therefore, the intrinsic trunk stiffness (K) was set at 727 Nm/rad (12.7 Nm/deg) and the neuromotor gain (G) was set at 526 Nm/rad (9.2 Nm/deg).

This lumped parameter model was created in Simulink (MATLAB, Natick MA) using variable step, Runge-Kutta differential equation solver. To simulate a sudden unexpected load, 100 Nm was applied to the system for 0.10 seconds. This pattern is similar to load cell patterns observed in experiment two. The model was initially run with the neuromotor gain constant at 526 Nm/rad and the detection threshold increasing from 0 to 5 degrees. A second run was also performed with the model, increasing the detection threshold from 0 to 5 degrees, but adjusting the gain to maintain a constant magnitude of neuromotor response.

## **Model Results**

The detection threshold of the neuromotor response was increased from 0 to 5 degrees to model the decreased sensory ability (increased position sense errors) observed experimentally while maintaining the neuromotor gain at 526 Nm/rad. As this detection threshold increases, a greater deflection is needed to activate the neuromotor response resulting in a delay in the neuromotor response (Figure 3). Both the initiation and the time to peak neuromotor response were observed to increase with increasing detection threshold. In addition, with neuromotor gain held as a constant linear value, the magnitude of the neuromotor response decreased with increasing detection threshold.

The overall trunk dynamics were also affected by the increase in detection threshold. With increasing detection threshold, the magnitude of the trunk flexion increased and the time to peak trunk flexion increased. Cholewicki et al. (2000) related such a change in overall trunk dynamics to a decrease in the stabilization of the trunk. What is not known from this initial analysis is whether the changes in trunk flexion are due to the increased detection threshold solely or the decrease in neuromotor response magnitude. A second analysis was, therefore, performed in which neuromotor gain was increased to maintain the magnitude of the neuromotor response with increasing detection threshold. In this second analysis, the neuromotor gain increased from 526 Nm/rad with a detection threshold of 0 degrees to 1132 Nm/rad with a detection threshold of 5 degrees. While the magnitude of the neuromotor response remained constant in these trials, the magnitude and time to peak of the trunk flexion, as well as the time to initiation and peak neuromotor response still increased with increasing detection threshold (Figure 4). From the model it can be predicted that if sensory ability changes, one should observe changes in the timing of the neuromotor response as well as changes in trunk flexion in response to an unexpected perturbation.

## **Experiment 2**

### **Participants:**

For the second experiment, a sudden trunk loading protocol was performed before and after exposure to WBV on the same exposure population as experiment one (10 female, 7 male, aged 22-33 [ $27.5 \pm 5.5$ ] years,  $168 \pm 8$  m,  $64 \pm 13$  kg). Vibration exposure

consisted of 5 Hz, 0.223 m/s<sup>2</sup> RMS WBV to an unpadded seat in the vertical (z-axis) direction for 20 minutes.

#### Instrumentation:

The 3-D electromagnetic motion analysis system (Motion Star, Ascension Technology, Burlington, VT) was again collected at 40 Hz to assess torso motion. Torso flexion was again defined as the angle between a line connecting the sensors over the T10 and S1 spinous processes and vertical.

Surface electromyographic electrodes (Delsys, Boston, MA) were attached to the skin over the right and left erector spinae muscle groups at L2/L3 level of the spine with 4 cm inter-electrode spacing. The electromyographic (EMG) data were collected at 1500 Hz. Raw EMG data were band-pass filtered between 20 and 500 Hz with several notch filters (40, 60, 80, 120, 180 and 240 Hz) to remove electrical and electromagnetic noise. The EMG data were rectified and integrated using a 100-point Hanning window. Prior to the experiment, isometric, maximum, voluntary exertions were performed. The subjects were instructed to perform three maximal extension exertions for five seconds against a fixed frame while standing with their pelvis fixed to a stationary support. The average of the integrated EMG (iEMG) for these maximal exertions was collected and used to normalize all subsequent iEMG signals. In addition to the EMG data, all other data (from a load and a contact switch) were simultaneously collected at 1500 Hz.

#### Procedure:

Sudden loading response dynamics were determined using a sudden drop protocol (Figure 5). The subject was asked to stand with extended knees and with his or her arms straight and relaxed at his or her sides. The subject's pelvis was fixed using a belt attached to a solid frame. The subject wore a harness across their chest to which a weight was attached by a Kevlar cable via a load cell and a pulley. The load cell recorded the tension in the cable. A small preload (0.5 kg) was applied to maintain tension in the cable. A sudden impulse was applied by dropping a 4.5 kg weight from a height of 10 cm. This load is similar to that used in previous sudden loading experiments (Cholewicki et al., 2000, Moorhouse and Granata, 2006, Wilder et al, 1996). This weight was allowed to bounce against springs attached to the weight holder to create an impulse load. A contact switch was used to indicate the instant the dropped weight made contact with the springs. Throughout the sudden loading protocol, the subjects stood behind a black curtain and wore headphones with music in order to block both auditory and visual cues. For each sudden loading trial, before the load was dropped, the subject was instructed to match his/her target lumbar curvature and flexion angle with visual biofeedback to ensure the same pre-perturbation posture throughout the experiment. Data was collected for 5 seconds for each sudden load.

#### Data Analysis:

EMG data from the right side Erector Spinae muscle group was analyzed to find the time to peak muscular activity (timePM). This timePM was defined as the time between the onset of the contact switch and the peak muscular response measured by iEMG. The torso flexion (TF) resulting from the sudden perturbation was defined as the

difference between the peak torso flexion and the average of the torso flexion 750 ms before the perturbation. Five trials of the sudden loading protocol were for each condition (before and after vibration exposure). The timePM and the TF from each of these trials were averaged for each subject in each condition as no significant difference was observed between trials within a condition.

Two-tailed, paired, student t-tests were performed with the time to peak muscle activity (timePM), and the torso flexion magnitude (TF) as dependent variables and time (before or after vibration exposure) as the independent variable. To adjust for the multiple dependent variables, a Bonferroni correction was applied, requiring a significance level of  $p < 0.025$ . These analyses were performed to test the hypotheses that timePM and TF would increase after exposure to WBV.

## **Experiment 2 - Results**

In the lumped parameter model, the increase in the position sense error and predicted decrease in sensory ability were modeled as an increase in the detection threshold of the neuromotor response. Using this model, such a decrease in sensory ability was predicted to lead to an increase in the timing of the neuromotor response (such as timePM) and in the trunk flexion (measured here as TF) with a sudden unexpected perturbation. The timePM was found to increase from  $205 \pm 61$  ms before vibration to  $228 \pm 43$  ms after exposure to WBV. A two-tailed, paired student t-test found this increase to be statistically significant ( $p < 0.025$ ). The TF was also found to increase from  $11.8 \pm 5.7$  degrees before vibration to  $13.2 \pm 5.6$  degrees after WBV exposure. This increase was also found to be significant in a two-tailed, paired student t-test ( $p < 0.025$ ).

## **Discussion**

Whole body vibration has long been known to be a risk factor for low back injury. This research suggests that changes in the proprioceptive system after vibration exposure may alter dynamic low back stabilization increasing risk of low back injury. In the first experiment, the position sense error ratio was found to be significantly increased with vibration exposure relative to unexposed controls. This increased error reflects loss in the ability to sense lumbar posture and suggests neuromotor habituation or adaptation with exposure to whole body vibration. Vibration of the muscle and/or tendon has long been known to stimulate the muscle spindle organs (Roll and Vedel, 1982, Shinohara, 2005). Vibrations below 80 Hz applied directly to the muscle or the associated tendon have been demonstrated to have a one-to-one association between the vibration and activity in the Ia afferents from the muscle spindle organs in a number of muscles including the tibialis anterior and extensor digitorum longus (Roll et al., 1989). This stimulation, which can cause kinesthetic illusions of muscle lengthening, has also been demonstrated to have longer term effects after removal of the vibration (Cordo et al., 1995, Shinohara, 2005, Wierzbicka et al., 1998). These effects include increases in the discharge threshold of the Ia afferents and inhibition of Ia terminals (Hayward et al., 1986, Hultborn et al., 1987, Shinohara, 2005). Such vibration has been shown, in the ankle, to decrease the amplitude of H reflexes in both the stimulated and synergistic muscles (Curtis and Eccles, 1960, Hultborn et al., 1987, Shinohara, 2005). Such vibration exposure has been demonstrated to alter overall joint dynamics as well, with vibration of the ankle tendons, for example, altering center of pressure trajectories in standing sway after vibration exposure

(Wierzbicka et al., 1998). This previous research, while predominately on the muscles of the extremities, suggests that vibration transmitted to the musculature of the trunk could alter sensory and reflex behavior. The increased position sense error ratio in subjects exposed to WBV in this study supports this possibility.

The next question is whether such a sensory change could affect low back stability. In this work, a model was created to examine the possible effects of an altered sensory threshold on dynamic trunk stabilization. Increasing the detection threshold of the neuromotor response was found in the model to increase the time to initiation and peak neuromotor response and to increase the trunk flexion in response to a sudden load. These increases occurred, even when the magnitude of the neuromotor response was maintained at constant levels by adjusting the neuromotor gain. Experimentally, these predictions were confirmed with increases in both the time to peak EMG response (timePM) and in the torso flexion (TF) with a sudden unexpected load. These findings agree with previous studies that have demonstrated increased delay in reflex response after exposure to axial WBV while seated in a flexed posture (Wilder et al., 1996).

Vibration has a number of characteristics including the duration and the frequency of the vibration. In the extremities, previous studies examining the post-vibration effects on the muscle spindle organs and neuromotor system have been performed at frequencies ranging from 20 to 150 Hz (Roll and Vedel, 1982, Roll et al., 1989, Shinohara, 2005). However, to the author's knowledge, no study has, as of yet, examined the frequency dependence of post-vibration changes in sensory behavior. Unlike directly applied muscle or tendon vibration, WBV transmission to the musculature is filtered through other soft tissues. As such, vertical, seat pan, WBV has been demonstrated to be



transmitted to the spine readily at frequencies at or below 4-6 Hz but is attenuated at higher frequencies (Griffin, 1990). Other modes of vibration transmission such as horizontal seat pan vibration and back rest vibration have different transmission characteristics (Griffin and Brett, 1997, Kitazaki and Griffin, 1998, Mansfield and Griffin, 2000, Pope et al., 1998, Pope et al., 1999). In this study, a frequency of 5 Hz was used to provide the greatest transmission of axial vibration to the musculature. However, the interaction of vibration transmissibility and vibration susceptibility of the neuromotor system as a function of frequency should be investigated further. Duration of exposure is another potential factor in the effects of vibration on the neuromotor system. This study investigated the effect of a short (20 minutes) exposure to whole body vibration relative to the exposure that might occur during a full workday. Longer exposures could yield more pronounced or differing effects. The effect of longer exposures should be studied further. Finally, the subjects in these two experiments were young adults without a history of occupational vibration exposure. Workers with experience in vibration exposure could potentially demonstrate altered response patterns. Future studies on these topics will further expand the understanding of whole body vibration and its effects on proprioception and trunk dynamics.

The time to peak muscle response (time<sub>PM</sub>) was found to average 218±63 ms. In the literature, experiments on sudden loading dynamics have delays in muscle response ranging from 127 to 205ms depending on the measurement method (Granata, Slota, & Wilson, 2004; Lavender, Marras, & Miller, 1993; Wilder et al., 1996). Two factors contribute to the slightly longer times observed in this study. The first is the use of the contact switch rather than the load cell to determine the beginning of the sudden loading.

Second, some of the studies have examined the onset rather than the peak muscular activation. In this experiment, the contact switch and the peak muscular activation were found to be more consistent measures and therefore preferable for determining changes delay times. While this method gave slightly larger delay times, they are consistent with previous sudden loading studies. However, some authors have suggested that postural response may be a combination of multiple reflex and voluntary responses that could be examined separately by looking at earlier and late muscular responses (Marden et al. 1981). Future examination of vibration induced changes in sudden loading dynamics should examine muscular response, particularly in the short latency involuntary reflex response, to further elucidate proprioceptive effects on postural control.

In conclusion, WBV has been shown to increase errors in the ability to sense and reproduce lumbar posture. Through modeling and experimental measurement, the role of the sensory system in the dynamic response to sudden loading has been demonstrated. For the truck driver, loss in the ability to accurately sense low back posture and to quickly respond to unexpected sudden loads could pose a risk. If the driver were to unload his or her truck after a period of vibration he or she may not be able to appropriately react to an unstable footing or unexpectedly heavy box. While isolating the driver from the vibration would be the ideal solution, such a driver might also benefit from a rest period after vibration to allow recovery of the proprioceptive system. Future work should examine this recovery time, as well as the other factors that may influence these effects including vibration frequency, exposure duration and subject experience.

**Acknowledgements:** The authors wish to acknowledge Maneesha Arashanapalli for her assistance in data collection. This work was supported by a Whitaker Foundation Biomedical Engineering Research Grant (RG-03-0043).

## References

- Bernard BP Musculoskeletal disorders and workplace factors. (pp. 94-213) Washington, D.C.: U.S. Department of Health and Human Services, 1997.
- Bluthner R, Seidel H, Hinz B. Examination of the myoelectric activity of back muscles during random vibration - methodical approach and first results. *Clinical Biomechanics* 2001;16:S25-S30.
- Bluthner R, Seidel H, Hinz B. Myoelectric response of back muscles to vertical random whole-body vibration with different magnitudes at different postures. *J Sound Vib* 2002;253(1):37-56.
- Bongers PM, Hulshof CT, Dijkstra L, Boshuizen HC, Groenhout HJ, Valken E. Back pain and exposure to whole body vibration in helicopter pilots. *Ergonomics* 1990;33(8):1007-26.
- Brumagne S, Cordo P, Lysens R, Verschueren S, Swinnen S. The role of paraspinal muscle spindles in lumbosacral position sense in individuals with and without low back pain. *Spine* 2000;25(8):989-94.
- Brumagne S, Lysens R, Swinnen S, Verschueren S. Effect of paraspinal muscle vibration on position sense of the lumbosacral spine. *Spine* 1999;24(13):1328-31.
- Cholewicki J, Juluru K, McGill SM. Intra-abdominal pressure mechanism for stabilizing the lumbar spine. *J Biomech* 1999;32(1):13-7.
- Cholewicki J, Simons AP, Radebold A. Effects of external trunk loads on lumbar spine stability. *J Biomech* 2000;33(11):1377-85.
- Cordo P, Gurfinkel VS, Bevan L, Kerr GK. Proprioceptive consequences of tendon vibration during movement. *J Neurophysiol* 1995;74(4):1675-88.
- Curtis DR, Eccles JC. Synaptic action during and after repetitive stimulation. *J Physiol* 1960;150:374-98.
- Feldman AG, Latash ML. Afferent and efferent components of joint position sense; interpretation of kinaesthetic illusion. *Biol Cybern* 1982;42(3):205-14.
- Fishbein WI, Salter LC. The relationship between truck and tractor driving and disorders of the spine and supporting structures; report of a survey. *Ind Med Surg* 1950;19(9):444-5.
- Frymoyer JW, Pope MH, Clements JH, Wilder DG, MacPherson B, Ashikaga T. Risk factors in low-back pain. An epidemiological survey. *J Bone Joint Surg Am* 1983;65(2):213-8.
- Gade VK, Wilson SE. Variations in reposition sense in the lumbar spine with torso flexion and moment load. American Society of Mechanical Engineers Summer Bioengineering Conference, Key Biscayne, FL, 2003.

- Granata KP, Sanford AS. Lumbar-pelvic coordination is influenced by lifting task parameters. *Spine* 2000;25(11):1413-8.
- Granata, K. P., Slota, G. R., & Wilson, S. E. Influence of fatigue in neuromuscular control of spinal stability. *Human Factors* 2004, 46(1), 81-91.
- Griffin MJ *Handbook of human vibration*. London, England: Academic Press Limited; 1990.
- Griffin MJ, Brett MW. Effects of fore-and-aft, lateral and vertical whole-body vibration on a head-positioning task. *Aviat Space Environ Med* 1997;68(12):1115-22.
- Hayward LF, Nielsen RP, Heckman CJ, Hutton RS. Tendon vibration-induced inhibition of human and cat triceps surae group I reflexes: evidence of selective Ib afferent fiber activation. *Exp Neurol* 1986;94(2):333-47.
- Hultborn H, Meunier S, Pierrot-Deseilligny E, Shindo M. Changes in presynaptic inhibition of Ia fibres at the onset of voluntary contraction in man. *J Physiol* 1987;389:757-72.
- Kitazaki S, Griffin MJ. Resonance behaviour of the seated human body and effects of posture. *J Biomech* 1998;31(2):143-9.
- Latash ML *Neurophysiological basis of movement*. Champaign, IL: Human Kinetics; 1998.
- Lavender, S. A., Marras, W. S., & Miller, R. A. The development of response strategies in preparation for sudden loading to the torso. *Spine* 1993, 18(14), 2097-2105.
- Magnusson ML, Pope MH, Wilder DG, Areskoug B. Are occupational drivers at an increased risk for developing musculoskeletal disorders? *Spine* 1996;21(6):710-7.
- Mansfield NJ, Griffin MJ. Non-linearities in apparent mass and transmissibility during exposure to whole-body vertical vibration. *J Biomech* 2000;33(8):933-41.
- Mansfield NJ, Marshall JM. Symptoms of musculoskeletal disorders in stage rally drivers and co-drivers. *Br J Sports Med* 2001;35(5):314-20.
- Marsden, C.D., Merton, P.A., & Morton, H.B. Human Postural Responses. *Brain* 1981; 104: 513-534.
- Moorhouse KM, Granata KP. Role of reflex dynamics in spinal stability: Intrinsic muscle stiffness alone is insufficient for stability. *J Biomech* 2006; (epub ahead of print).
- Pope MH, Hansson TH. Vibration of the spine and low back pain. *Clin Orthop Relat Res* 1992;279:49-59.
- Pope MH, Magnusson M, Wilder DG. Kappa Delta Award. Low back pain and whole body vibration. *Clin Orthop* 1998;354:241-8.
- Pope MH, Wilder DG, Magnusson ML. A review of studies on seated whole body vibration and low back pain. *Proc Inst Mech Eng [H]* 1999;213(6):435-46.
- Roll JP, Vedel JP, Ribot E. Alteration of proprioceptive messages induced by tendon vibration in man: a microneurographic study. *Exp Brain Res* 1989;76(1):213-22.
- Roll JP, Vedel, J.P. Kinaesthetic role of muscle afferents in man, studied by tendon vibration and microneurography. *Exp. Brain Res.* 1982;47(2):177-90.
- Seroussi RE, Wilder DG, Pope MH. Trunk muscle electromyography and whole body vibration. *J Biomech* 1989;22(3):219-29.
- Shinohara M. Effects of prolonged vibration on motor unit activity and motor performance. *Med Sci Sports Exerc* 2005;37(12):2120-5.
- Solomonow M. Ligaments: a source of work-related musculoskeletal disorders. *J Electromyogr Kinesiol* 2004;14(1):49-60.

- Wierzbicka MM, Gilhodes JC, Roll JP. Vibration-induced postural posteffects. *J Neurophysiol* 1998;79(1):143-50.
- Wilder DG, Aleksiev AR, Magnusson ML, Pope MH, Spratt KF, Goel VK. Muscular response to sudden load. A tool to evaluate fatigue and rehabilitation. *Spine* 1996;21(22):2628-39.
- Wilson SE, Granata KP. Reposition sense of lumbar curvature with flexed and asymmetric lifting postures. *Spine* 2003;28(5):513-8.
- Winter DA. *Biomechanics and motor control of human movement*. N.Y.: Wiley-Interscience; 1990.

## Figure Legends

Figure 1. The position sense error ratio, defined as the average position sense error after exposure condition over the average position sense error prior to exposure condition, was found to increase significantly with vibration exposure.

Figure 2. A model of the trunk in response to sudden loading was created to examine how errors in proprioception could be linked to dynamic trunk stabilization. In this model, the trunk was modeled as a simple inverted pendulum with a mass ( $M$ ), an inertia ( $I$ ), a preparatory trunk stiffness ( $K$ ), a damping constant ( $B$ ) and a delayed neuromotor response. The increased errors in proprioception were modeled as an increase threshold to detect trunk motion in the neuromotor response.

Figure 3. While holding the neuromotor gain constant, the detection threshold of the neuromotor response ( $Th$ ) was increased from 0 to 5 degrees. This resulted in changes in the neuromotor response including increases in the time to initiation and to peak neuromotor response and decreases in the magnitude of the neuromotor response (A). The peak torso flexion magnitude also increased with increasing detection threshold (B).

Figure 4. In the second run, the neuromotor gain was adjusted to maintain a constant magnitude of neuromotor response with increasing detection threshold. Increases in the time to initiation and to peak neuromotor response were again observed (A). The peak torso flexion magnitude also increased with increasing detection threshold (B).

Figure 5. The sudden loading protocol was performed with the subject standing with their pelvis fixed to a rigid restraint. The sudden load was applied via a chest harness. A Kevlar cable, connected through a pulley and load cell, was attached to a preload base. A 4.5 kg weight was dropped 10 cm and allowed to bounce against the base creating an impulse load. Headphones with music and a curtain prevented audio and visual cues.

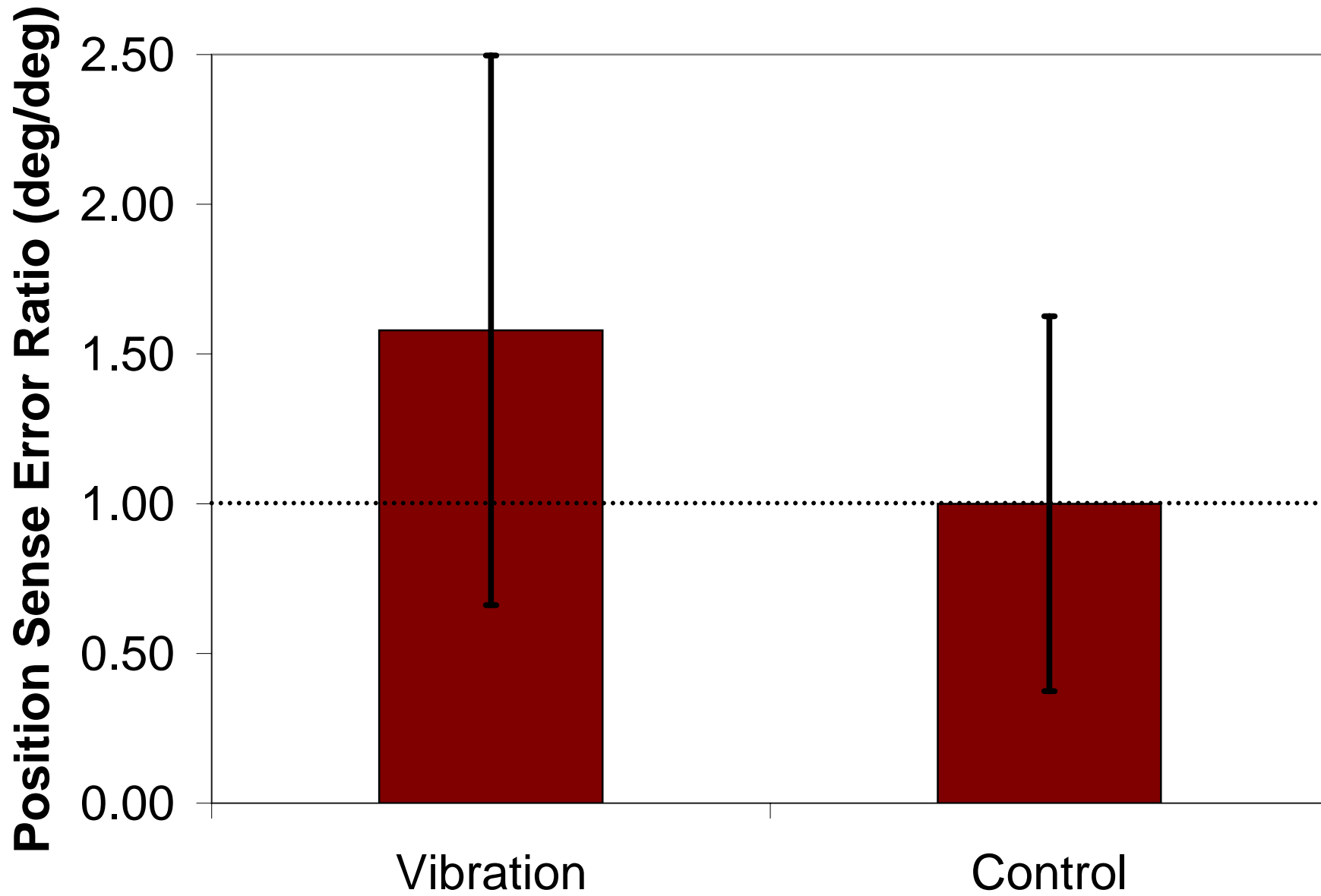

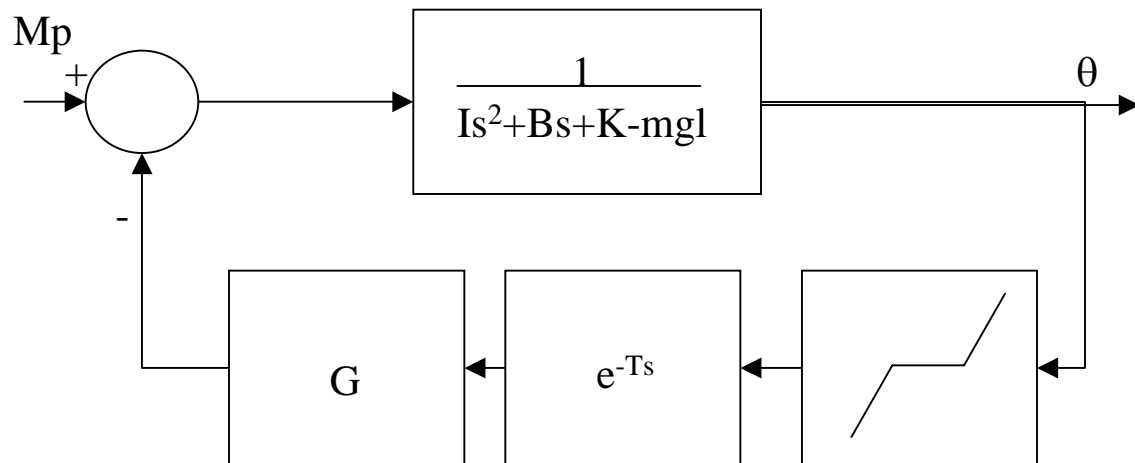
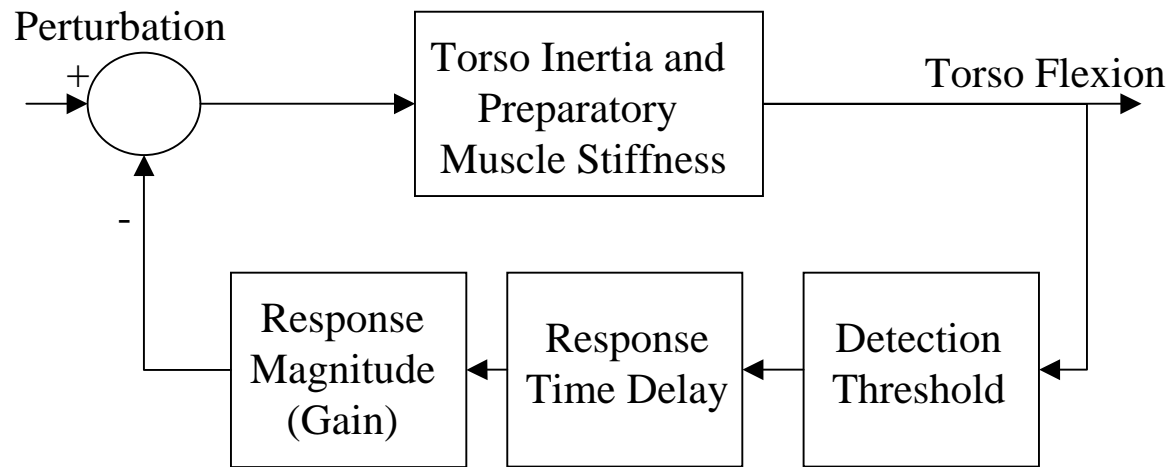
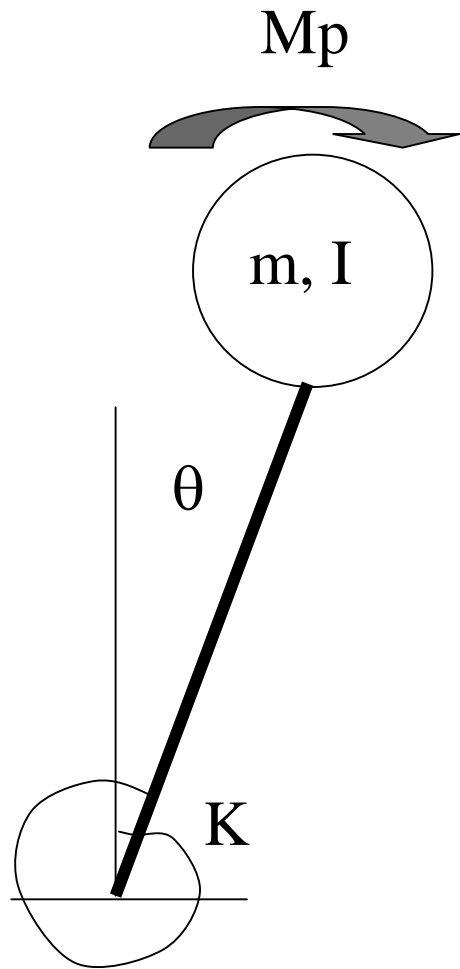



Figure 3

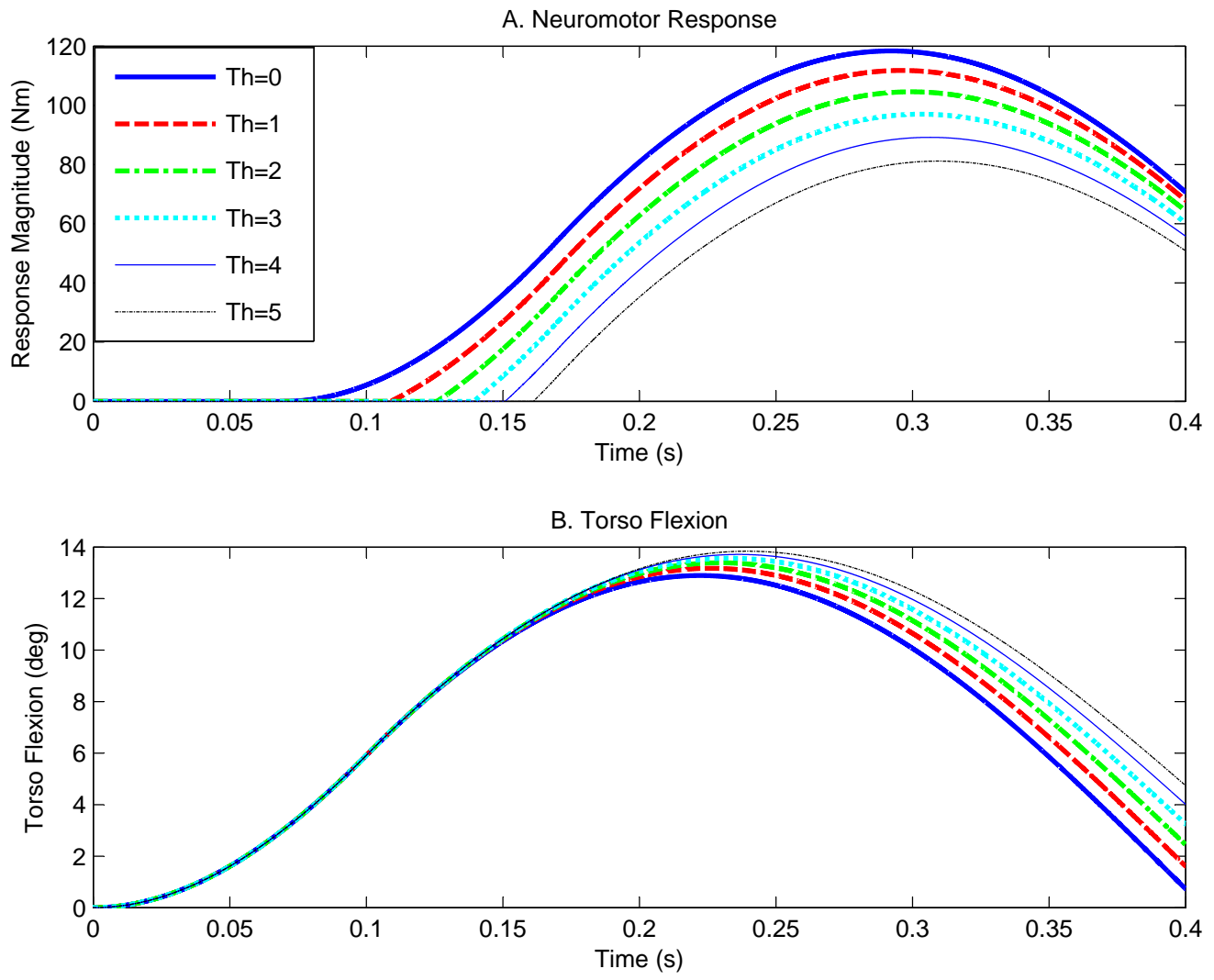
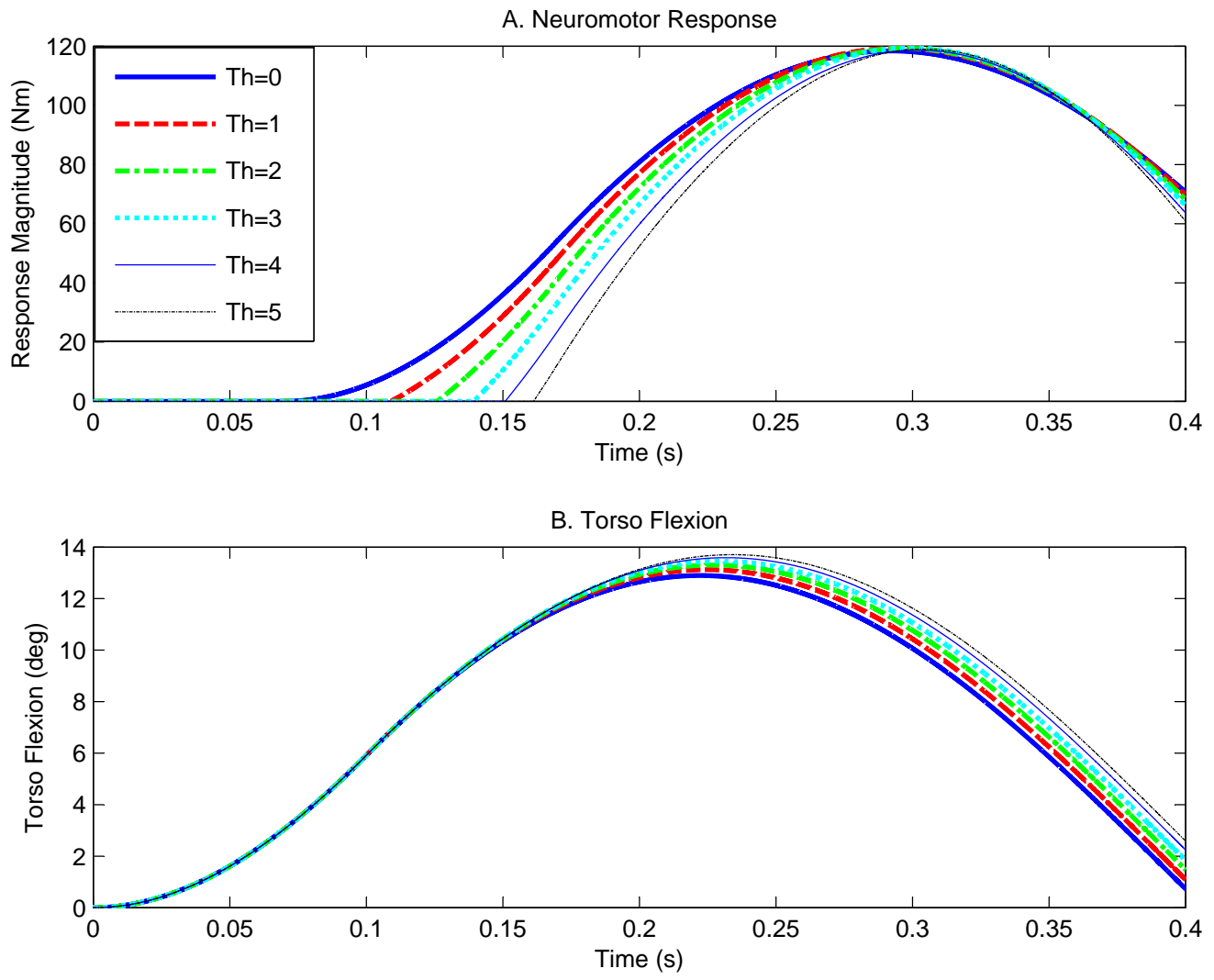
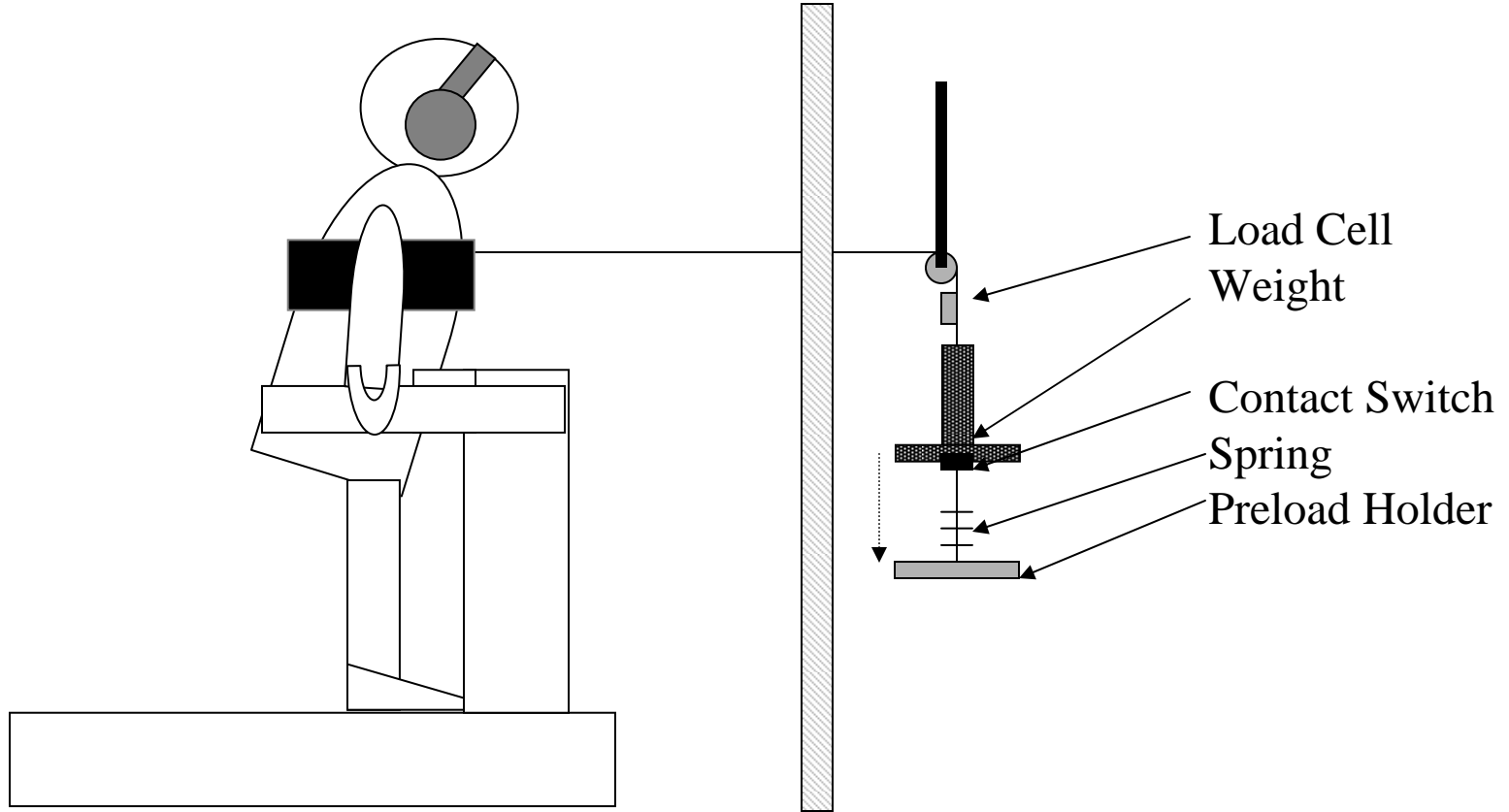

Figure 4



Subject

Curtain



Load Cell  
Weight

Contact Switch  
Spring

Preload Holder

