

Special Paper

Challenges for Coring Deep Permafrost on Earth and Mars

S.M. Pfiffner,¹ T.C. Onstott,² T. Ruskeeniemi,³ M. Talikka,³ C. Bakermans,⁴ D. McGown,²
E. Chan,² A. Johnson,⁵ T.J. Phelps,⁶ M. Le Puil,¹ S.A. Difurio,¹ L.M. Pratt,⁵ R. Stotler,⁷ S. Frape,⁷
J. Telling,⁸ B. Sherwood Lollar,⁸ I. Neill,⁹ and B. Zerbin¹⁰

Abstract

A scientific drilling expedition to the High Lake region of Nunavut, Canada, was recently completed with the goals of collecting samples and delineating gradients in salinity, gas composition, pH, pe, and microbial abundance in a 400 m thick permafrost zone and accessing the underlying pristine subpermafrost brine. With a triple-barrel wireline tool and the use of stringent quality assurance and quality control (QA/QC) protocols, 200 m of frozen, Archean, mafic volcanic rock was collected from the lower boundary that separates the permafrost layer and subpermafrost saline water. Hot water was used to remove cuttings and prevent the drill rods from freezing in place. No cryopegs were detected during penetration through the permafrost. Coring stopped at the 535 m depth, and the drill water was bailed from the hole while saline water replaced it. Within 24 hours, the borehole iced closed at 125 m depth due to vapor condensation from atmospheric moisture and, initially, warm water leaking through the casing, which blocked further access. Preliminary data suggest that the recovered cores contain viable anaerobic microorganisms that are not contaminants even though isotopic analyses of the saline borehole water suggests that it is a residue of the drilling brine used to remove the ice from the upper, older portion of the borehole. Any proposed coring mission to Mars that seeks to access subpermafrost brine will not only require borehole stability but also a means by which to generate substantial heating along the borehole string to prevent closure of the borehole from condensation of water vapor generated by drilling. Key Words: Mars—Deep subsurface biosphere—Planetary protection—Planetary instrumentation—Microbial ecology. *Astrobiology* 8, 623–638.

Introduction

FOLLOWING THE WATER in the search for extant life on Mars will ultimately lead to the acquisition, by drilling, of subsurface samples at a depth of ~0.3 to 3 km (Mancinelli, 2000). Such a mission poses challenges not only in terms of autonomous drilling (Zacny and Cooper, 2006; Zacny *et al.*, 2008) but also in terms of contamination of the samples and

the environment (Smith and McKay, 2005). Sampling subsurface sediments, rocks, or fluids for evidence of organic carbon, cellular constituents, or bioprocesses has presented unique challenges in the past. Collection, processing, and even the archiving of subsamples require multiple levels of stringent quality assurances and quality controls (QA/QC) to ascertain the validity of any evidence that indicates the presence of cellular building blocks or life-forms (live, dead,

¹Center for Environmental Biotechnology, University of Tennessee, Knoxville, Tennessee.

²Department of Geosciences, Princeton University, Princeton, New Jersey.

³Geological Survey of Finland (GTK), Espoo, Finland.

⁴Center for Microbial Ecology, Michigan State University, East Lansing, Michigan.

⁵Indiana-Princeton-Tennessee Astrobiology Initiative (IPTAI), NASA Astrobiology Institute, Indiana University, Bloomington, Indiana.

⁶Oak Ridge National Laboratory, Oak Ridge, Tennessee.

⁷Department of Earth Sciences, University of Waterloo, Waterloo, Ontario, Canada.

⁸Department of Geology, University of Toronto, Toronto, Ontario, Canada.

⁹Wolfden Resources Inc., Thunder Bay, Ontario, Canada.

¹⁰Major Drilling Group International Inc., Winnipeg, Manitoba, Canada.

or either live or dead). Similarly, each analysis conducted on sample aliquots requires independent QA/QC and extensive use of process controls to validate observations and identify sources of potentially compromising contamination. Coring introduces contamination from the drilling tools, from cuttings and drilling fluids, from sloughing within the borehole, and from contact with the atmosphere. Both native tracers, such as bromide or sulfate ions, and added conservative tracers (*e.g.*, solids, microspheres, and perfluorocarbons) (Colwell *et al.*, 1992; Onstott *et al.*, 1994; Kieft *et al.*, 1995; McKinley and Colwell, 1996) have been used for decades to track drilling contamination and ascertain the quality of samples retrieved for biological and chemical assays. Fluorescent microspheres were introduced as tracers for subsurface transport studies by Harvey *et al.* (1989) and since have become a mainstay for assessing the potential transport of bacterial-sized particulates into cores. Microspheres have been utilized during the Ocean Drilling Program's Leg 185 and subsequent excursions to monitor bacterial contamination from the seawater used when coring deep-sea sediments (Smith *et al.*, 2000), including methane hydrate-rich deep-sea sediments (Reed *et al.*, 2002).

Inert perfluorocarbon tracers (PFTs) have been widely used to identify potential intrusion of gases or liquids (Senum and Dietz, 1991; Colwell *et al.*, 1992; Smith *et al.*, 2000). Being chemical tracers, PFTs can be easily added as a liquid or gas and are then able to penetrate small pore spaces. Their low solubility creates gas partitioning; and, with electron capture detection, PFT concentrations can be quantitatively measured at sub-picogram levels (Phelps and Fredrickson, 2001). Sensitive detection coupled with moderate cost has facilitated PFT use in ocean drilling projects (Smith *et al.*, 2000). Recently, PFTs have even been used to monitor CO₂ injection and transport in brine-filled reservoirs for geologic sequestration (Freifeld *et al.*, 2005).

Major limitations on QA/QC regimens, however, are posed by any martian mission designed to penetrate hundreds of meters through frozen rock and regolith. Traditionally, large-diameter coring tools (60–80 mm) have been employed that enable detailed biogeochemical and tracer analyses to be performed on innermost subcores shielded from surface exposure (Russell *et al.*, 1992; Griffin *et al.*, 1997; Phelps and Fredrickson, 2001). Essentially, the vast majority of cored materials protected the innermost zones that were subsequently accessed by paring with sterile tools under an inert gas phase. Immediately upon paring, the innermost samples were stored in sterile containers under an inert atmosphere at low non-freezing temperatures and then promptly analyzed. Large-diameter coring is not feasible for robotic martian missions because of the obvious weight and power limitations. Decreasing the diameter of cored materials increases the surface-area-to-volumetric ratio and the linear discontinuity from fracturing or breaks in the core. The internal portions of the core will likely be exposed to drilling artifacts, drilling fluids, and extraneous gas phases. Cores with small diameters and highly exposed surface areas with low volumes are too small for subsampling and may require more judicious coring procedures with more rigorous QA/QC providing multiple lines of evidence to validate observations. The QA/QC are also more challenging because the use of artificial tracers has been precluded by COSPAR for any samples that potentially

would be returned to Earth for analyses (DeVincenzi *et al.*, 1998).

Deep permafrost environments, whether on Earth or Mars, pose a significant new challenge to QA/QC since phase changes will occur during the coring process (Zacny *et al.*, 2004) and moisture and heat may introduce deleterious effects upon the subsurface microorganisms, which would require ever more reliance on rigorous coring controls with particulate and gaseous tracers. Previous studies of coring in permafrost have been restricted to very shallow depths of a few meters (Juck *et al.*, 2005; Gilichinsky *et al.*, 2007; Steven *et al.*, 2007); and, though some have penetrated cryopegs (Bakermans *et al.*, 2003), none have penetrated permafrost into a subpermafrost aquifer. If such an aquifer were at lithostatic pressure, then penetration by drilling could lead to a potentially catastrophic release of volatiles.

Objectives

The objectives of the Indiana-Princeton-Tennessee Astrobiology Initiative drilling expedition in the Canadian Arctic were to obtain experience in coring deep permafrost environments as a means for developing QA/QC for an analogous martian mission and to characterize the microbial ecosystem present at great depth in permafrost environments. More specifically, we sought to (1) obtain rock cores from within and beneath the deep permafrost layer using aseptic QA/QC protocols, (2) delineate the depth of permafrost on site, (3) obtain fluid samples from beneath a deep permafrost layer, (4) determine the composition and isotopic abundances of gases from beneath the permafrost and gases (including any hydrates) from within the permafrost, (5) determine the composition, origin, and age of the subpermafrost water and of ice and pore water from within the permafrost, and (6) determine whether gradients in salinity, gas concentration, pH, pe, microbial abundance, and activity exist at the lower boundary between permafrost and saline water.

This research at High Lake was carried out in cooperation with the Permafrost Project, which was co-funded by participants from Finland (Geological Survey of Finland and Posiva), Sweden (Svensk Kärnbränslehantering, SKB), and Canada (Nuclear Waste Management Organization and University of Waterloo).

Materials and Methods

Field site and geologic setting

In the Nunavut Territory of Canada, the High Lake mining property (67°22'47"N, 110°50'37"W) is located north of the Arctic Circle, south of Coronation Gulf, and west of the Bathurst Inlet. Based on the records of the nearest weather stations (Lupin Mine and Kugluktuk), the mean annual air temperature is assumed to be around –11°C. The site is within the zone of deep continuous permafrost.

The High Lake greenstone belt that hosts the High Lake volcanogenic massive sulphide deposit is a remnant of a complex, polydeformed, and variably metamorphosed Archean (*ca.* 2.7 Ga old) volcano-sedimentary terrain, and it extends over 100 km in north-south direction (Henderson *et al.*, 2000). The dominant rock types in the vicinity of the massive sulphide deposit are felsic metavolcanic and metavol-

canoclastic rocks, which are associated with lesser mafic metavolcanic and carbonate-rich metasedimentary rocks (Petch, 2004). The sequence of supracrustal rocks strikes north-northeast, dips steeply to the west, and is truncated to the west by a large granodioritic intrusion (Petch, 2004).

According to Petch (2004), the economically significant Cu-Zn sulphide deposit comprises massive and stringer chalcopyrite-pyrrhotite-pyrite \pm galena and was formed in a seafloor environment by replacement of a porous volcanic pile. The sulphide-bearing rocks typically are hydrothermally altered, and the center of the mineralized zone is intensely chloritized and locally metamorphosed to distinctive domains of anthophyllite-magnetite-cordierite rock. Peripheral to the mineralized domain, the alteration consists of sericitization, silicification, and weaker chloritization. Enriched metals in the deposit include copper, zinc, lead, gold, and silver.

The deposit was originally discovered by recognition of the gossans (natural acidic drainage formations that result from the surficial oxidation of the pyritic ore), which were readily visible in satellite images. Approximately 80,000 m of core have been collected from this mining property by Wolfden Resources Inc. over the past 2 years while exploring the subsurface extent of this sulfide deposit. Because no mining activities were planned for several years for this property, long-term access to subpermafrost water could be secured. The mining camp is only accessible between February and November, by floatplane in the summer months and an ice runway in winter; the surrounding mining property is accessible by helicopter. The hydrology of the High Lake site has recently been described by Freed *et al.* (2007).

Drill site selection

The thickness of the permafrost was estimated to be ~400–440 m from exploration drilling. Because the costs for coring through this permafrost into the subpermafrost zone exceeded the budget available, we opted to extend one of the existing boreholes. The borehole also had to be within walking distance of the camp to lower the helicopter costs for transporting equipment to the drill rig. Because all the exploration boreholes had been drilled with heated CaCl_2 brine, which would adversely impact interpretation of the geochemical data, the selected borehole needed to be located far away from any previously drilled boreholes that may have penetrated the permafrost in order to have the lowest probability of having been contaminated by the previous drilling activities. Based on these criteria, three NQ size (75 mm outer diameter) boreholes (HLW-03-32, HLW-03-30, and HLW-03-28) were selected from a candidate suite of 20–30 boreholes. Of these three, HLW-03-28, which was located on a ridge ~0.7 km southwest of the mining camp at an elevation of ~360 m above sea level and was 325 m long and dipping at an angle of 65°, was selected because (1) it was the farthest from any previously drilled boreholes that may have penetrated the permafrost and (2) the projected extension of the borehole would intersect a potential major fault striking N-S along the western edge of High Lake (Fig. 1), thereby offering a better chance of intersecting water. The horizontal projection of the HLW-03-28 drill hole would extend between the 2 small lakes, both of which are too small to have a talik that penetrates the permafrost. A belt of gossans also

occurs vertically above the borehole, which suggests that the borehole intersects a sulfide deposit at depth.

As is the case with all these boreholes, HLW-03-28 was filled with ice formed from leftover drilling brine and surficial meltwater. The drill rig was mobilized by helicopter for installation at the borehole. The drillers set a short casing to the top of the permafrost at 4 m; then, using 21% CaCl_2 brine heated by coil stoves and an NQ bit, they drilled out the ice and frozen slough in the old borehole over the course of 5 days. With the drill rods still in the hole, hot fresh water was circulated through the borehole for 5 days to flush out the CaCl_2 brine. This protracted interval of heated, fresh water circulation prevented the drill string from freezing to the borehole once the coring commenced. Although the water was heated to 80–90°C in the coil heaters, it was only 30–35°C by the time it returned the top of the borehole. One coring run was made with the NQ bit before switching to the NQ3 bit that was used, because PVC core liners were to be used to reduce contamination of the microbial cores. When the dimensions of the wireline system, drill rod, inner barrel, and core line are accounted for, the resulting rock core was 47 mm in diameter.

An HPLC pump was attached to the high-pressure (~2750 kPa) drilling water line where it left the coil heaters and before it entered the drilling rods. A perfluorocarbon tracer (PFT) containing perfluoromethylcyclohexane (PMCH) and perfluorodimethylcyclohexane (PDMCH) solution was diluted to 1% with tap water and pumped into this line at 8–10 ml min^{-1} as the drill water was pumped into the drill rods at ~30 L min^{-1} (3.3×10^{-6} dilution) (Senum and Dietz, 1991; McKinley and Colwell, 1996; Phelps and Fredrickson, 2001). The PFT was pumped into the drill water during the entire coring operation in order to evaluate whether any mixing of the drill water with saline cryopeg water was occurring. The drilling water was not recirculated but was pumped to a settling pond after it passed through a sludge container. Samples of drill water were collected from the sump can at the base of the drill rig for conductivity analyses and for PFT with every core run. The PFT samples were collected in 25 ml serum vials, sealed with Teflon septa and Al crimp seals, and stored inverted at ambient temperature (Freifeld *et al.*, 2005). Select samples were also filtered for geochemical analyses. Samples for cations (filtered by 0.45 μm and acidified) and anions were collected in Nalgene bottles and stored at room temperature, whereas samples for organic acids and total and dissolved organic carbon were filtered into 15 ml Falcon tubes and stored frozen (Onstott *et al.*, 2005).

Cores for microbial analyses were collected every seventh core run for a total of 10 cores. Cores that were not used for microbial analyses were logged on site. Core samples were collected from these cores for UV spectral analyses because fluorescent microsphere tracers had not been inserted into the inner core barrel as they were for the microbial cores (Fig. 2). Immediately prior to a microbial core run, PVC core liners (3 m) were sterilized with methanol and inserted into the inner, wireline core tube (Fig. 2). A Whirl-Pak® bag filled with 5 ml of 1 μm latex fluorescent microspheres (10^9 spheres/ml, Fluoresbrite™ microspheres, Polysciences Inc., Warrington, PA) was inserted into the core catcher at the bottom of the core tube (Harvey *et al.*, 1989; Chapelle and McMahon, 1991; Russell *et al.*, 1992; Fredrickson *et al.*, 1993). Tem-

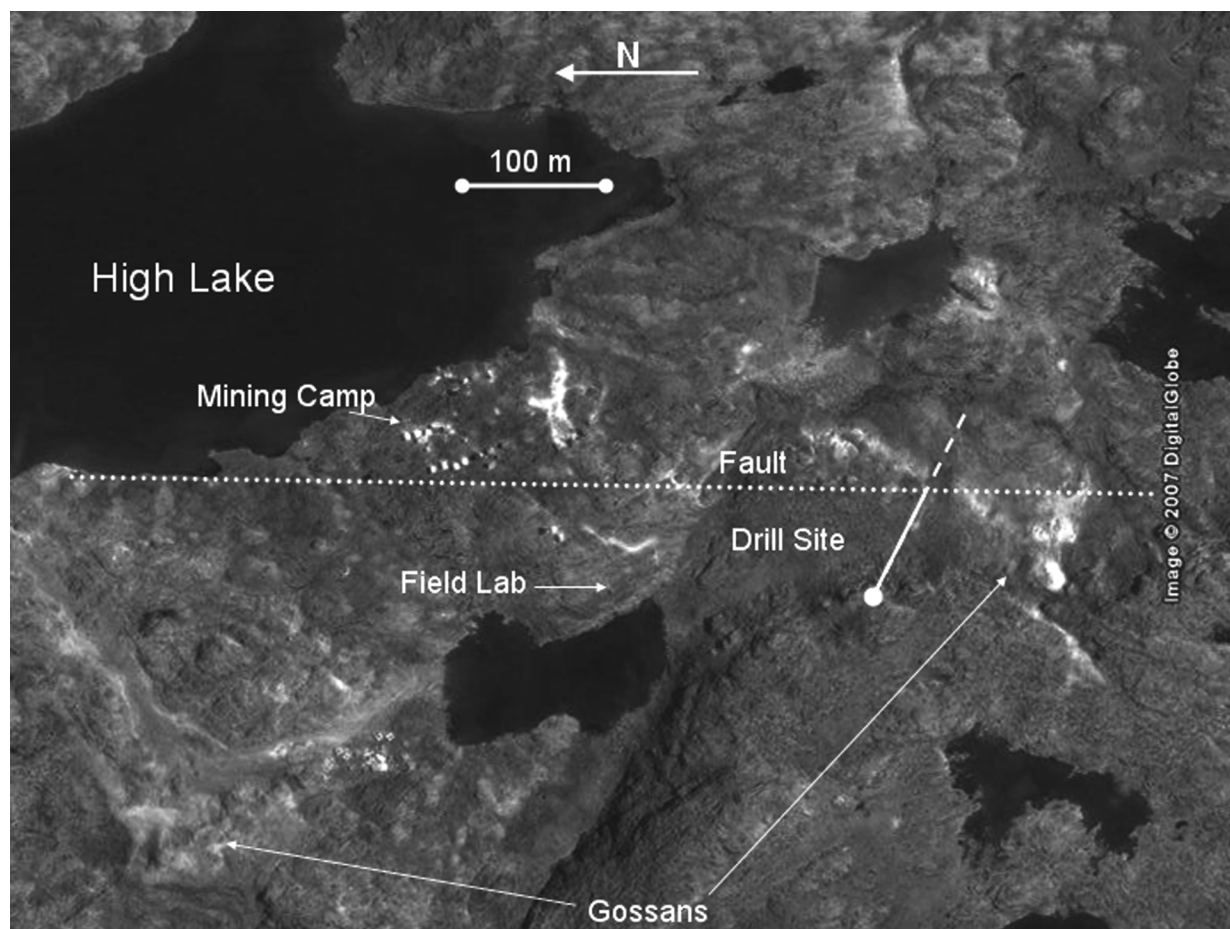

FIG. 1. Satellite Photo (courtesy of Digital Globe) of High Lake mining property showing mining camp, field laboratory, and drill site. Surface trace of the borehole is indicated. Solid line represents borehole drilled prior to 2006 using brine, and dashed line represents borehole extended during this study. The lightly shaded deposits are gossans.

perature monitoring strips were inserted between the core liner and the core barrel to measure the maximum temperature experienced by the core run (Colwell *et al.*, 1992). The core barrel was then lowered down the drill rods. As the core entered the wireline coring tool, the bag ruptured, releasing the microspheres, and was then pushed to the top of the core barrel (Fig. 2). Samples of the inlet water and water from the mud line sump can were collected for PFT analyses as soon as coring began. Approximately 30 minutes after coring began, samples of water from the sump can were collected for DNA/RNA and lipid analyses in 50 ml Falcon tubes, and samples for enrichments were collected in 140 ml glass sterilized serum vials over-pressurized with N₂. Samples of water from the sump can were collected for microsphere and cell count analyses in 15 ml Falcon tubes. These samples were stored on blue ice in a cooler located at the drill site until they were received at the core processing shed, where the DNA and lipid samples were frozen with dry ice. A gas stripper was attached to the mud line, which was designed to enable the collection of gas samples if clathrate deposits were encountered during drilling.

When the coring run was completed and the wireline core barrel was brought to the surface, the core liner and core were pushed from the coring tube, cut into 4 log sections

(0.75 m), capped at each end, and placed in a cooler with blue ice. The cooler was filled with Ar gas to keep the core as anaerobic as possible, and the cooler was carried downhill to the core processing shed where the Coy anaerobic glove bag (Coy Laboratory Products Inc., Grass Lake, MI) with Ar headspace was installed. The cores in the core liner were transferred into the glove bag onto sterile paper. The core liner was removed, the core segments photographed and logged, and the core segments broken with a sterile hammer and placed into separate Whirl-Pak[®] bags, each of which were labeled with an investigator's name. The position and length of each investigator's core was noted. Whirl-Pak[®] bags for DNA and lipid samples were passed out of the glove bag and placed on dry ice in a cooler. Whirl-Pak[®] bags for activity or biological samples were placed in Mason jars (Ar headspace), which were passed out of the glove bag and placed in a cooler with blue ice. Core chips were collected in 15 ml Falcon tubes for microsphere analysis and in serum bottles for PFT analysis.

Cores collected to determine the chemical, mineralogical, and physical properties of the rock core were placed in separate Whirl-Pak[®] bags with no special storage requirement. Determinations or analyses included mineralogical and physical properties of the rock core, fracture mineralogy,

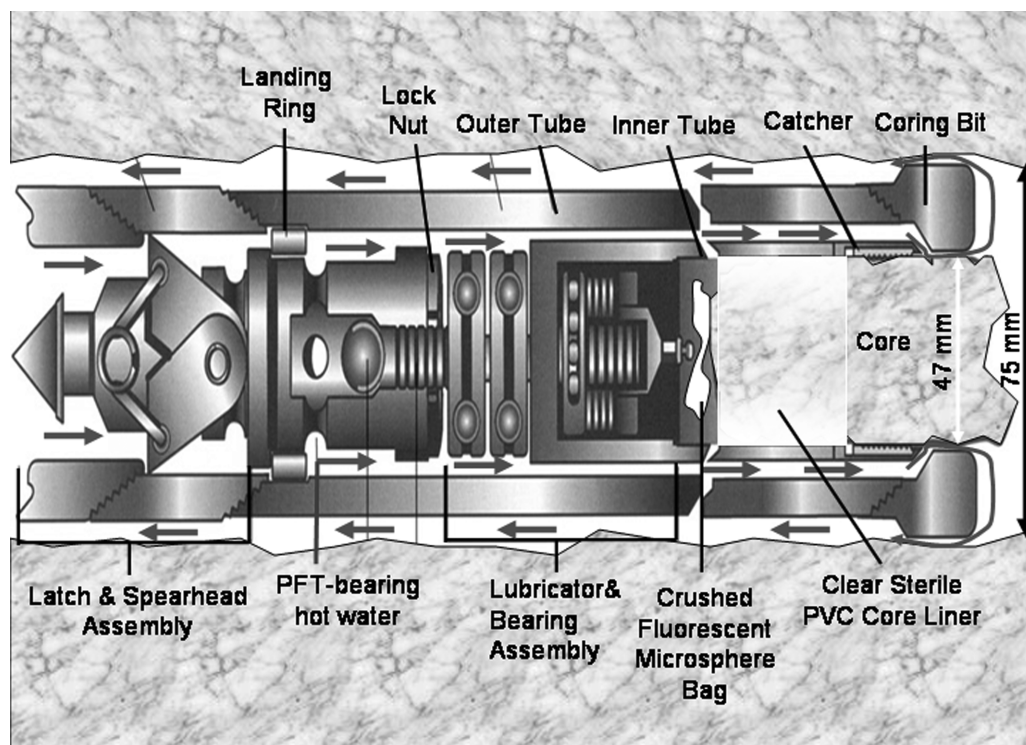

FIG. 2. Diagram of typical wireline tool that was used for coring. A PVC core liner separated the core from the inner tube. Fresh hot water containing PFT was circulated down inside the drilling rods, passed between the outer core barrel and core catcher, out the head of the bit, and back up the borehole. The Whirl-Pak[®] bag containing the fluorescent microspheres was usually found broken at the top of the core barrel.

fluid inclusion, porosity, geophysical properties, $\delta^{13}\text{C}$ and $\delta^{18}\text{O}$ isotopes on calcite and total organic C, S isotopes on sulfides, S-O isotopes on sulfate, sulfur isotopes, and crush and leach chemistry for organics, inorganics, $\delta^{81}\text{Br}$ and $\delta^{37}\text{Cl}$ isotopes, and chemical diffusion experiments. Cores for voltametric analyses were placed in Whirl-Pak[®] bags and stored by 2 methods: refrigerated in anaerobic jars or frozen with dry ice. Microbial diffusion experiment cores were stored in anaerobic jars and refrigerated.

Because the core segment that was wedged in the core catcher was the last part of the core to be drilled and, potentially, the most microbially contaminated as it was outside the liner, it was selected for the pore gas analyses. In the core processing shed, a 7–9 cm long section of this segment was placed inside a stainless steel canister. Each canister lid was comprised of a Con-flat blank flange with a $\frac{1}{4}$ inch diameter, 20 cm long Cu tube connected with a VCR coupling to an opening in the center of the flange. The rock core was sealed inside the canister by bolting on the flange sealing a Cu O-ring by knife edges in the lid and canister. The canister was carried downhill to the machine shop where the Cu tube of the canister was attached to a mechanical vacuum pump through a Swagelok connection. The canister was evacuated and flushed with high-purity Ar 3 times. After the canister was evacuated, a fourth time, the Cu tube was sealed with a refrigeration clamp at approximately 15 cm from the top of the lid.

The rate of penetration averaged ~ 30 m per day with a 24-hour operation. Coring continued for 7 days, until we obtained a downhole depth of 535 m (or 200 m of core). At this

point, we determined that we were below the base of the permafrost by turning off the water circulation for several hours, raising the bit a meter off the base of the borehole, and then lowering it back down. While in the permafrost, this procedure would result in the drill's encountering the resistance of partially frozen drill water, but once below the permafrost zone no resistance was felt. At this point, the wireline core tube was removed, and a temperature probe was lowered down the drill string, which yielded 7–8°C at the bottom of the hole. The bottom of the drill string was blocked, and a "wet" pull was quickly performed to remove as much drill water as possible from the borehole before it froze to the rock surface. A casing was then inserted into the borehole to a depth of 320 m to maintain stability in the permafrost region and to prevent any residual brine in the rock formation from flowing into the borehole and any water (from melting ice in the permafrost zone) from flowing out and partially sealing the hole. The rest of the drilling water was then removed with an 18 L volume bailer that was dropped down the hole and raised 19 times during a 12-hour shift. The temperature of the water after bailing was $\sim 2.8^\circ\text{C}$. The conductivity of the bailed water varied from 1.8–4.10 mS/cm. The next day, four additional bailer samples were taken. The conductivity had increased to 7.96 mS/cm or $\sim 4,500$ ppm total dissolved solids, which is more than 100-fold higher than the lake water used for the flushing water. This bailed water was filtered for lipid and DNA analyses. In addition, we collected a sample for PFT, cation, anion, organic acid, and total and dissolved organic carbon analyses.

In total, about 400 L of water was removed from the hole in order to lower the water table into unfrozen conditions and remove contaminating drilling water. During the process, the borehole water cleared of the rock dust from drilling, and the increasing trend in salinity appeared to indicate that the amount of formation water was steadily increasing in the mixture. The water level was determined by a downhole conductivity measurement to be at 492 m, and an initial estimate of the influx rate was ~ 1 L/hour. The borehole iced closed at a depth of 125 m, however, capturing the downhole probe in the process. An attempt to drill out the ice without the use of water failed. Further attempts at sampling the borehole during this field season ceased at that point. Samples were shipped out in coolers with either blue ice or dry ice.

The last samples taken were of the lake water, which was filtered with $0.2 \mu\text{m}$ Anodisc filters and frozen on dry ice for cell count, DNA, and lipid analyses (Moser *et al.*, 2005). Lake water was sampled and preserved with Zn acetate for sulfur isotope analysis (Moser *et al.*, 2005).

Pore gas analyses

After arrival at Stable Isotope Laboratory in Toronto, the copper tube sampler was attached to a vacuum line through a piercing system sealed around the copper tube. The sampler atmosphere (*i.e.*, gases released by the core sample) was transferred to the line and compressed to 5 psi above atmospheric pressure with an inverted Toepler pump. The gas was sampled with gas-tight syringes (Valco Instruments Company Inc.) through a septa port. A Varian 3400 gas chromatograph (GC), which houses a 30 m, 0.53 mm (inner diameter) fused silica capillary column (GSQ, J and W) and a flame ionization detector, was used to analyze for organic gases (C_1 to C_5). The temperature program was 35°C for 5 min, $5^\circ\text{C}/\text{min}$ to 110°C and then $10^\circ\text{C}/\text{min}$ to 220°C , 220°C for 5 min. A Varian 3800 GC, which houses two 30 m, 0.32 mm (inner diameter) fused silica capillary columns (Molecular Sieve, J and W) and a micro thermal conductivity detector, was used to analyze for inorganic gases (helium, hydrogen, nitrogen, oxygen and carbon dioxide). The temperature program was 35°C for 7 min, $10^\circ\text{C}/\text{min}$ to 230°C , 230°C for 10 min.

Core physical properties

A representative subcore was sent to Core Petrophysics for Hg porosimetry analyses (Onstott *et al.*, 2003).

Aqueous chemistry and stable isotopes

Cation and anion analyses of the water samples were performed via inductively coupled plasma mass spectrometry and ion chromatography at the Geolaboratory of the Geological Survey of Finland. Stable isotope analyses of $\delta^2\text{H}$, $\delta^{18}\text{O}$, and $\delta^{37}\text{Cl}$ were performed at the Environmental Isotope Laboratory at the University of Waterloo. Oxygen isotope analysis was performed on a Micromass 903 triple collector SIRA mass spectrometer consistent with the standard preparation procedures of Epstein and Mayeda (1953). Deuterium determinations were made following the chromium reduction preparation method of Morrison *et al.* (2001) and analyzed on an Isoprime (GV instruments) isotope ratio mass

spectrometer coupled with an elemental analyzer (Eurovector) mass spectrometer. Oxygen and deuterium results are reported as parts per thousand (‰) with respect to Vienna Standard Mean Ocean Water. Analytical precision for $\delta^{18}\text{O}$ and $\delta^2\text{H}$ are 0.2 and 1.0‰, respectively. Samples for chlorine stable isotope ($\delta^{37}\text{Cl}$) analyses were prepared from methods of Taylor and Grimsrud (1969) and Kaufmann *et al.* (1984) by precipitating AgCl from the chloride-containing solution and creating CH_3Cl gas. Measurements were completed on a dual inlet Isoprime isotope ratio mass spectrometer (Micromass, currently GV Instruments, UK).

Perfluorocarbon tracers

Over 150 PFT samples were collected during the drilling operation. The PFT concentration was measured with a Hewlett Packard 5890 GC equipped with a 50 m RT-Alumina (Restek Corporation, Bellefonte, PA) capillary column and an electron capture detector (ECD) (Lagomarsino, 1996; Freifeld *et al.*, 2005). Each of the samples was analyzed by GC with duplicate $10\text{--}50 \mu\text{l}$ injections via a gas-tight syringe. The GC-ECD was calibrated with a PFT dilution series for both PMCH and PDMCH dissolved in methanol and water. These standards were analyzed at the beginning and end of each GC working day to ensure accuracy throughout the analysis. GC detection of PFTs was reported as an area count, which could be converted to a concentration based on standard curves.

Microsphere tracers

An Applied Spectral Imaging (ASI, Migdal Ha'Emek, Israel) platform, comprised of an Olympus BX61 deconvolution microscope, an ASI interferometer-based spectral head, and a high-definition charge-coupled device camera (VDS Vosskühler GmbH, Osnabrück, Germany), was used to view the fluorescent microspheres in the drill water and core chip samples at $100\times$ total magnification ($10\times$ objective). Drill-water samples (0.5 ml) were filtered through $0.2 \mu\text{m}$ polycarbonate filters. The microspheres on the core chips were qualified in a plus/minus test. Spectral scans of 15 fields of view per sample were performed with a filter cube that allows acquisition and separation of the microsphere fluorescent signal (excitation: 487–507 nm; emission: 514–550 nm). The imaging platform allowed acquisition of specific spectral signatures for each pixel of the image and, therefore, allowed separation of the microsphere fluorescent signal from the inherent noise signal of the sample material. Based on previous works (Chang *et al.*, 2003; Biggerstaff *et al.*, 2006; Le Puil *et al.*, 2006), a quantitation protocol was derived by way of AutoDeblur[®] (AutoQuant Imaging Inc., Watervliet, NY). Fluorescence areas were quantified for each image to obtain the density of microspheres in each field of view.

Lipid analyses

Drill water and rock core lipid analyses were stored at -80°C prior to sample preparation and analysis. Portions of each core were crushed in a Coy anaerobic glove bag such that a portion of the core was archived for future analysis. Approximately 100 g of samples were crushed with an ethanol flame-sterilized rock crusher, hammer, chisel, and steel plate. The crushed cores were collected in sterile Whirl-Pak[®]

bags and stored at -80°C prior to phospholipid fatty acid (PLFA) extraction and analysis.

We were unable to pare the core or process it in a similar technique to that used by Juck *et al.* (2005) to obtain a sterile inner core. This may have been due, in part, to the much smaller diameter of our core (47 mm compared to 62–73 mm) and the rock structure, in which chips sheared at angles across the core rather than along the length or across the diameter of the core. Thus, archived samples were treated by a surface sterilizing technique prior to crushing. Archived samples for 4 cores that showed higher biomass estimates were pretreated with a surface sterilization technique prior to crushing. This sterilization was performed by placing the frozen cores in a 1:1 (v:v) methanol/chloroform (to remove organic soluble contamination). They were then quickly dried with nitrogen gas prior to entering the anaerobic chamber. The rock crushing equipment was also surface sterilized with 1:1 (v:v) methanol/chloroform and then quickly dried with N_2 gas.

The PLFA composition was analyzed consistent with procedures described by Pfiffner *et al.* (2006) and White and Ringelberg (1998). The total lipids from the crushed core material (75 g) were extracted by a modified, single-phase, chloroform-methanol-phosphate buffer procedure (Bligh and Dyer, 1959; White *et al.*, 1979). The total lipid was fractionated on a silicic acid column, and the neutral and polar lipid fractions were collected (Tunlid *et al.*, 1989). The polar lipid was transesterified into fatty acid methyl esters by mild alkaline methanolysis for gas chromatography/mass spectrometry (GC/MS) analysis (Guckert *et al.*, 1985; White and Ringelberg, 1998). The fatty acid methyl esters were identified and verified via GC/MS (Matreya Inc. Pleasant Gap, PA). The lipid profiles were used to calculate biomass as pmol/g. Biomass was converted to cell numbers with the use of 2.5×10^4 cells pmol $^{-1}$ (Balkwill *et al.*, 1988).

Microbial cultivation assays

Rock cores for aerobic cultivation were stored at 4.5°C in sterile Whirl-Pak[®] bags. To access the interior of samples, cores were split in half lengthwise in a laminar-flow hood with a core splitter (rented from Deakin Equipment, Vancouver, BC, Canada) fitted with a brand-new blade; the entire core splitter was surface sterilized with 70% ethanol before each sample was processed. Prior to splitting, samples were surface sterilized by immersion in ice-cold 10% bleach for 5 minutes. The surface of the core was sampled with a sterile cotton swab before and after surface sterilization; swabs were streaked on plates of marine agar and $0.1 \times$ tryptic soy agar and incubated at 4°C to verify the efficacy of surface sterilization procedures and identify surface contaminants. Following surface sterilization, cores were immersed in 0.1% crystal violet to stain the outer surface of the rock and were split in half lengthwise with the core splitter. One half of the core was then placed on marine agar or $0.1 \times$ tryptic soy agar (solid media was prepared, sterilized, and allowed to solidify in quart-sized Mason jars placed on their sides) with the freshly-fractured surface of the rock in contact with the agar and incubated at 4°C for two months.

Rock cores for anaerobic cultivation were stored at 4.5°C in sterile Whirl-Pak[®] bags within Mason jars with Ar headspace. These cores were surface sterilized in a Coy anaero-

bic glove bag prior to crushing. While cold, the cores were placed in a cold 70% ethanol solution for 1 minute with slight agitation, followed by two 1% Na pyrophosphate buffer rinses with slight agitation. The cores were dried with sterile paper towels. The cores were then crushed with a sterilized rock crusher, chisel, hammer, and a steel plate. Seven different anaerobic media containing either H_2/CO_2 or N_2/CO_2 as the headspace gases were inoculated with 1 gram of crushed core. Anaerobic heterotrophic medium consisted of a dilute peptone, tryptone, yeast extract, and glucose (PTYG) medium at quarter and full strength. PTYG contained, in grams per liter, the following: glucose, 0.1; yeast extract, 0.1; peptone, 0.05; tryptone, 0.05; $\text{MgSO}_4 \cdot 7\text{H}_2\text{O}$, 0.6; and $\text{CaCl}_2 \cdot 2\text{H}_2\text{O}$, 0.01 (Balkwill *et al.*, 1989). Other anaerobic media started with phosphate-buffered basal medium that contained, in grams per liter, the following: NaCl, 0.9; $\text{MgCl}_2 \cdot 6\text{H}_2\text{O}$, 0.2; $\text{CaCl}_2 \cdot 2\text{H}_2\text{O}$, 0.1; and NH_4Cl , 1.0. This medium also contained trace mineral solution (10 ml/L), $10 \times$ vitamin solution (1 ml/L), 20% MOPS solution (0.5 ml/L), and 0.1% resazurin solution (2.0 ml/L) (Phelps *et al.*, 1994). Phosphate buffer was added post autoclave to a final concentration of 2.0 mM. Cysteine-HCl (0.5 gram per liter) was used as the reducing agent. Iron-reducing medium contained 10 mM sodium lactate and 30 mM amorphous iron. Sulfate-reducing medium contained 20 mM sodium sulfate and 40 mM each of sodium lactate and sodium acetate, and some tubes had the addition of yeast extract (0.05%) or fatty acids (5 mM each of acetate, pyruvate, and lactate). Methanogen medium contained 40 mM each of sodium acetate and methanol, and some tubes had the addition of yeast extract (0.05%). The cultures were incubated at 4.5°C and checked biweekly for growth.

Rock cores for culture-independent molecular analyses were collected and frozen at -80°C . Sample analyses have not been completed.

^{35}S microautoradiography

Radioisotope methods are extremely sensitive, and given that psychrophilic and psychrotolerant microorganisms are notoriously slow growers, the incubation times were arbitrarily set to the maximum time that is useful for $^{35}\text{SO}_4$. $^{35}\text{SO}_4$ was selected because 16S ribosomal DNA analyses of subpermafrost water from Lupin Mine, which is approximately 300 km southwest of High Lake, indicated that sulfate-reducing bacteria dominated the bacterial community. ^{35}S microautoradiography was performed on rock cores at Princeton University consistent with the procedure of Krumholz *et al.* (1997). The rock cores were removed from their Whirl-Pak[®] bags inside a Coy anaerobic glove bag. The outside surfaces of the cores were irradiated with a UV wand as a means of deactivating any surface contaminants that might have appeared during shipping or within the glove bag. The core was quickly split, and 100 μl of 10 μCi $^{35}\text{SO}_4$ was added to each fracture surface. Because the cores often had a metamorphic foliation, the fracture occurred at an oblique angle to the core axis. Silver foil was sandwiched between the fracture surface, and the 2 ends of the core taped together. The core was then slid into clear PVC tubing, and the ends packed with filling and wrapped with duct tape so that the fracture surfaces would press tightly against the Ag foil. The PVC tubes were placed inside Mason jars with Caddy Paks,

sealed, and placed in the refrigerator, where they incubated for ~120 days at 4°C. After incubation, the Ag foils were removed and imaged with a molecular dynamics imager. The rate of sulfate reduction was calculated for each “hot spot” of AgS by quantification of the imager response with standards and use of the formula presented in Kallmeyer *et al.* (2004). A control core that had been baked at 500°C for 24 hours in Al foil was utilized as a process blank.

Results

The temperature strips used to monitor temperature within the core barrel proved inaccurate, as their temperature quickly equilibrated with air temperature upon removal from the core barrel. Nevertheless, they appeared to record increasing temperature with depth if retrieved and read quickly. No elevated conductivity spikes were observed in the return water, which suggests that cryopegs were not intersected. No gas was observed to exsolve from the return drill water in the gas stripper. Cores collected for pore gas analyses also yielded no detectable gas. The porosity of the cores was also below the detection limit by Hg porosimetry for these samples (<0.3%).

Core lithology and fracturing

During the extension drilling of borehole HLW-03-28, approximately 200 m of rock core was recovered of which 30 m (10 samples) was collected for microbial, chemical, and mineralogical analyses. The drilling intersected units of intermediate metavolcanic rock (dacite lapilli tuff) and felsic metavolcanic rocks (rhyolite) (Fig. 3). The rock names and descriptions were based on macroscopical observations in the field.

The dacite lapilli tuff (337–414 m, 440–535 m) was fine-grained, weakly to moderately foliated, and contained roundish or elongated lapillites up to 1 cm in diameter. The more felsic rhyolitic flow (414–440 m) consisted of quartz and feldspar phenocrysts in a fine-grained matrix and typically had a massive appearance.

Both rock types have been subjected to hydrothermal alteration, chloritization being the most common type. Also sericitization, silicification, and albitization are present to a lesser extent. The degree of alteration varied from weak to strong and was generally more intense in the dacite lapilli tuff unit. Sulphides, *e.g.*, pyrite, pyrrhotite, and chalcopyrite, existed as grains, grain clusters, weak dissemination, or bands, and were typically related to calcite-filled fractures or intensely altered sections.

There were no fracture logs available from the previously drilled part of the hole (0–335 m), but the drilling report identifies a few intensely sheared zones up to several meters in width. To avoid the complications the collapse of these zones might cause to the future access to the hole, a steel casing was installed extending to the depth of 320 m. During the extension drilling, a detailed fracture density and fracture infilling loggings were carried out for the core, except for the ten 3 m sections collected for the microbe studies (Fig. 4). Several zones of intense fracturing were observed, but in general the fracturing was relatively sparse. Most of the logged fractures had slickensides (chloritized surfaces), evidencing movement along the fracture planes, and almost all had calcite ± sulphide infillings. No shearing or appar-

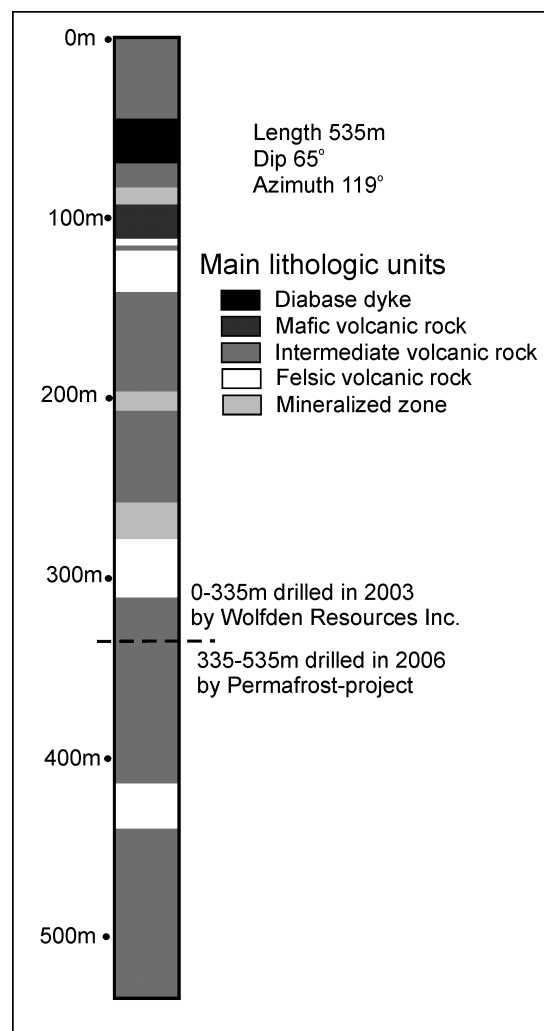

FIG. 3. Lithostratigraphic log of core from borehole. The main lithologic units were diabase dyke (black), mafic volcanic rock (dark gray), mineralized zone (light gray), intermediate volcanic rock (medium gray), and felsic volcanic rock (white).

ent chemical alteration (other than slickensides) is related to the fractures. The orientation of the fractures is variable, but subvertical sets are dominant. Most of the fractures seem tight with respect to the water flow, but reactivation of ancient structures was probably common and cannot be recognized from the core.

Aqueous chemistry and stable isotopes

Comparison of the isotopic composition of the drill water with that of the bailed saline water from the borehole revealed that they were indistinguishable. All the High Lake water samples, including surface samples, are distinct from the meteoric water line as shown in Fig. 5 (Craig, 1961). They are likely on a local meteoric water line; however, we have no precipitation samples from the High Lake area. Although the conductivity and the chemical composition of the bailed water was distinct from that of the drill water (Fig. 6), the ^{37}Cl analyses results strongly suggest that the higher salinity is due to the drilling salt used in preparing drilling brines

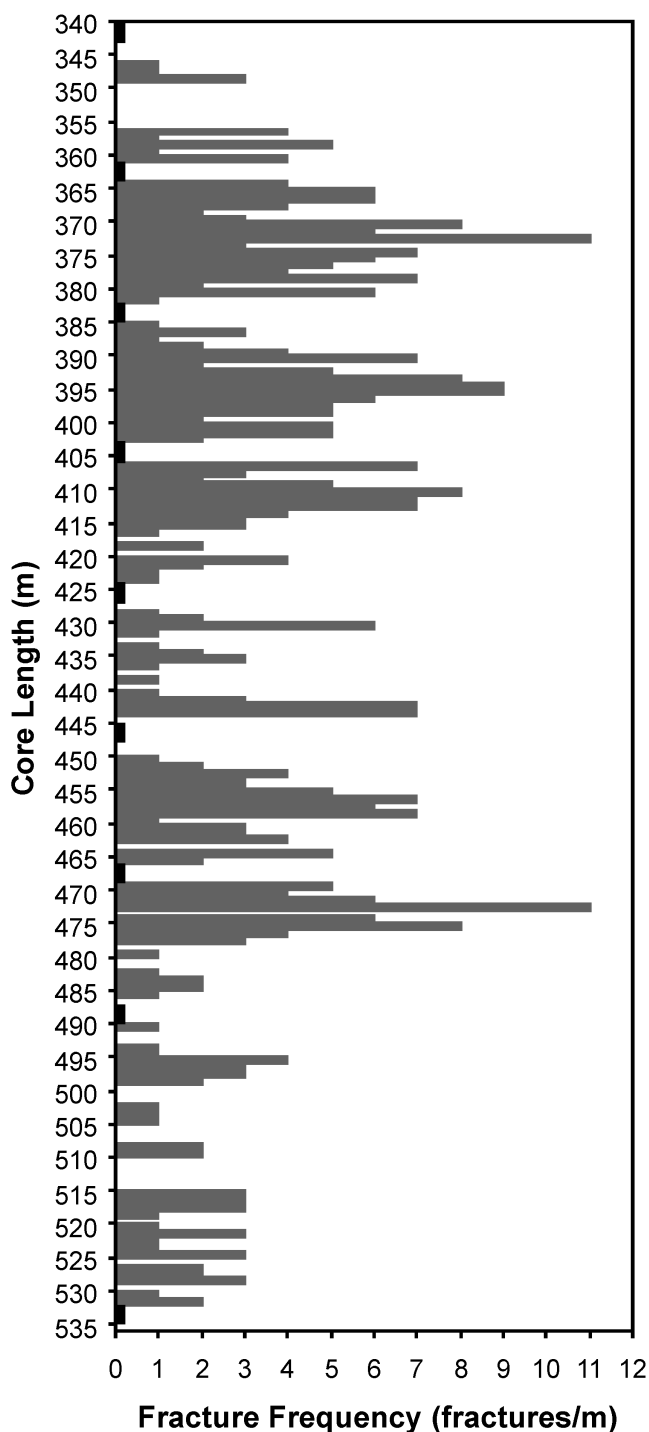

FIG. 4. Fracture frequency (fractures/m) for the extension drilling of the borehole HLW-03-28. The black 3 m bars show the locations of microbial core samples.

(Fig. 7). The borehole was prepared with a CaCl₂ brine prior to drilling, though it is possible other end members may exist. The Na versus Ca plot (Fig. 8) shows the influence of drill brine on surface water samples.

Perfluorocarbon tracers

PMCH/PDMCH concentration, measured at both drill-water inflow and outflow, was in the ng g⁻¹ range. Subsur-

face rock core parings and inner rock core samples were collected to determine the extent the drilling water contaminated any of the core samples. The PFT concentration of the parings ranged from 0–289 pg g⁻¹, which indicates ~3 orders of magnitude lower than the drill water. The concentration of PFTs in the drill water was not consistent, however, and it appears to be related to the time of mixing of the 1% solution and its addition to the reservoir container of the HPLC pump.

Microsphere tracers

Eight drill-water samples were collected at a range of depths from 361–535 m, which corresponded to the microbiological cores. Microsphere concentrations in the recovered drill water ranged from 3–5 × 10⁵ beads per ml. The exterior of core chips presented microsphere contamination. Figure 9b shows the exterior surface contamination by microspheres where ~2 × 10⁵ beads per cm² were quantified. Core chips were fractured to investigate in-depth contamination. Figure 9d shows the lack of bead penetration into the core, with extensive attachment of microspheres up to the fracture line and an absence of such contamination beyond it.

Phospholipid fatty acid analysis

A total of 19 rock and 10 drill-water samples were analyzed for phospholipid fatty acids (PLFAs). For some of the 3 m core samples, a second sample was collected. Biomass estimates on non-surface-sterilized core ranged from 0.6–32.1 pmol g⁻¹ or 1–80 × 10⁴ cells g⁻¹. Five core samples had biomass values below detection limits of 1 pmol PLFA g⁻¹. Four of the highest biomass samples, which ranged from 5.5–32.1 pmol/g, had PLFA profiles containing normal saturates, terminally branched saturates, monounsaturates, and polyunsaturates. These samples were selected for steriliza-

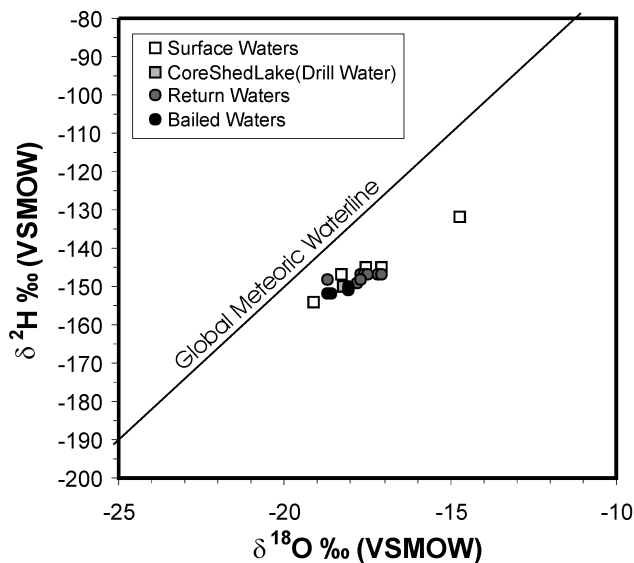

FIG. 5. δ²H versus δ¹⁸O plot of High Lake water samples with the global meteoric water line (GMWL). Water sample included surface water (open square), inflow drill water (gray square), returned (outflow) drill water (gray circle), and bailed borehole water (black circle).

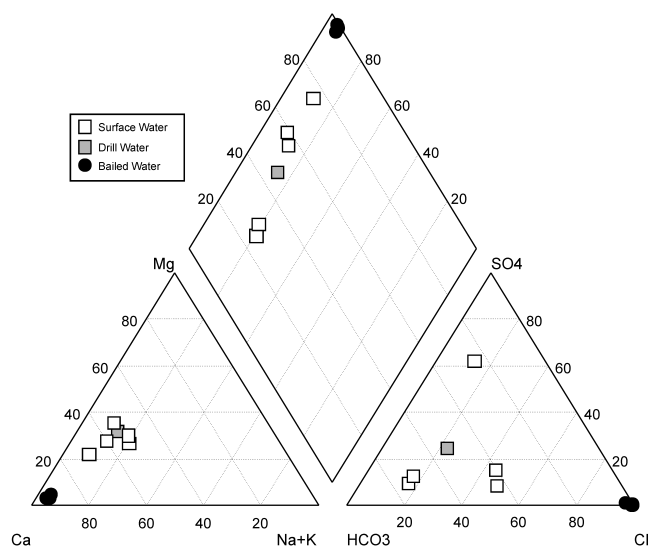

FIG. 6. Piper diagram of High Lake drill water (gray square), lake or surface water (open square), and bailed borehole water (black circle).

tion prior to crushing, extraction, and PLFA analysis. The surface sterilization significantly reduced the PLFA concentration, with the PLFA falling below the detection limit for 3 cores and the PLFA decreasing to 1.3 pmol g^{-1} for one core. Thus the surface sterilization of the cores significantly reduced the biomass values. The fatty acid methyl esters detected in the surface-sterilized cores were 16:0, 18:0, and 20:0.

Of the 10 drill-water samples analyzed, 4 had biomass estimates greater than $1 \text{ pmol PLFA ml}^{-1}$ (detection limit). Those drill-water samples with detectable biomass ranged from $24\text{--}595 \text{ pmol PLFA ml}^{-1}$ or $0.6\text{--}14 \times 10^6 \text{ cells ml}^{-1}$. These samples were from the drilling water inflow line, the outflow line (at the sump can) prior to the first microbial core, and outflow during the drilling of core 361 and 424. PLFA biomass was not detected in 6 of the drill-water samples.

Results of PLFA analyses reveal that the inflow water sample had a simple profile that consisted of normal saturated and monounsaturated fatty acids, while the outflow drill-water samples had more diverse profiles. The diversity of the outflow profiles was demonstrated by the presence of terminally branched and mid-chain-branched saturates, polyunsaturates, and cyclopropyl and hydroxyl fatty acids (Fig. 10).

Microbial cultivation assays

For aerobic cultivation, the surface sterilization of samples with 10% bleach was effective; no growth was observed on plates of surface swabs after sterilization, though abundant growth was seen on plates of surface swabs before sterilization. Isolation of microorganisms was attempted from the interior of the rock samples by splitting the cores in half lengthwise and placing the freshly fractured surface on nutrient media and incubating at 4°C . Following incubation, microbial growth was observed from the interior of 6 of the 10 rock samples. No growth was observed in cores from depths of 361, 445, 532, and 534 m. Interestingly, three of these (445,

532, and 534 m) samples had no, or minimal, surface contamination, which suggests that inhibitory substances within the rock may have prevented growth. Identification (via sequencing a portion of the 16S rRNA gene) of 10 interior isolates and 12 surface contaminants revealed a variety of common soil bacteria from *Pseudomonas* to *Flavobacterium* (Table 1).

For anaerobic cultivation, enrichment cultures that showed turbidity as a positive indication of growth were verified microscopically. Crushed core from a depth of 323–385 m had growth in the heterotrophic, sulfate-reducing, and methanogenic media. Heterotrophic growth was seen in core samples from 8 other depths.

^{35}S microautoradiography

^{35}S microautoradiographic analysis detected very heterogeneous response with most cores, yielding high levels of sulfate-reducing activity $\sim 100\times$ that of the baked-rock control cores, whereas some cores were indistinguishable from the baked-rock control core (Fig. 11). The sulfate reduction activity ranged from 4×10^{-6} to $2 \times 10^{-4} \text{ nmol cm}^{-3} \text{ day}^{-1}$. The ^{35}S hot spots appear to occur along intergranular fractures within the core. In most cases, the sulfate reduction activity was higher within the core than on the outside of the core, which suggests that the cores were not contaminated with drilling fluid.

Discussion

The nominal 1.25 m hr^{-1} penetration rate through metavolcanic rock, achieved with 30 L min^{-1} of hot water, was a striking contrast to the lack of visible penetration through ice when coring without the hot water and 2750 kPa. This is because the bit tends to polish the ice rather than penetrate it, as partial melting and subsequent freezing cause the ice to fill the spaces between the bit teeth and produce a

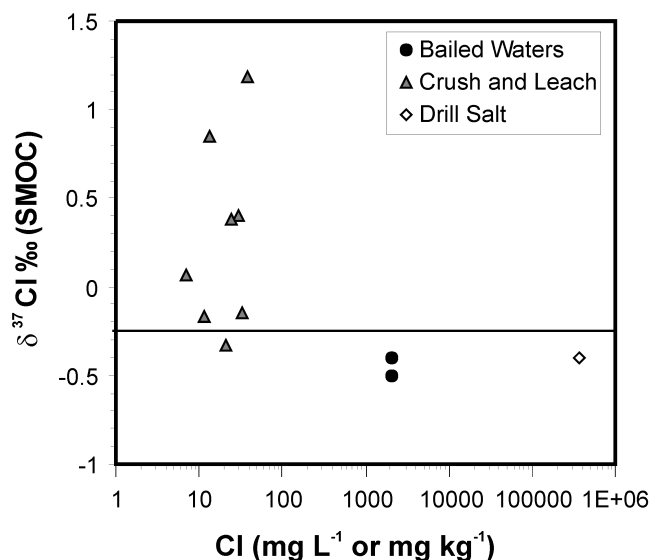

FIG. 7. $\delta^{37}\text{Cl}$ versus Cl^- concentration of bailed water from the borehole (black circle) compared to that of the on-site salt used for making drilling brine (open diamond) and the matrix fluid (crush and leach fluid) (gray triangle).

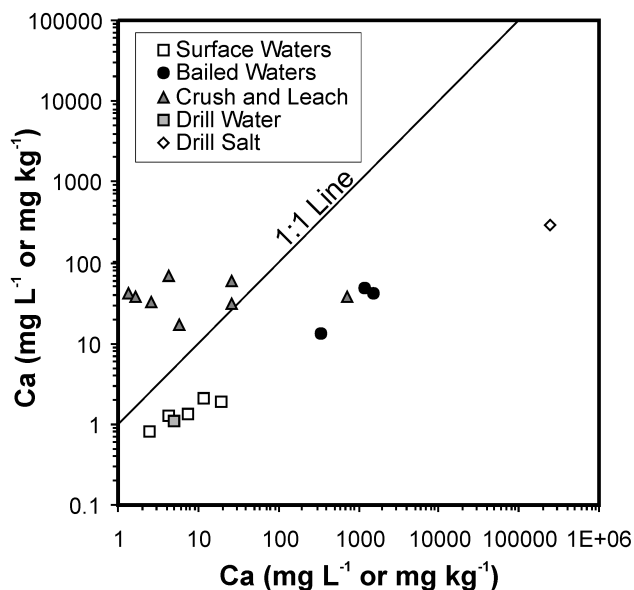

FIG. 8. Na versus Ca concentration plot compares samples from surface waters (open square), bailed waters (black circle), crush and leach fluids (gray triangle), drill water (gray square), and drill salt (open diamond).

smooth, slippery surface on the bit face (Zacny and Cooper, 2006). If the coring bit were heated, as proposed by Mancinelli (2000), it is possible that it could penetrate the ice without the use of heated drilling water. But when coring rock, drilling fluid is still required to lift the cuttings. The temperature tape, though inaccurate due to how quickly it could be read, seemed to indicate that the coring did not significantly heat the core. Although the water was heated to 80°C in the coil heaters, it was only 30–35°C by the time it had returned to the top of the borehole and must have cooled significantly after traveling through 400+ m of drill rod and rock. This is important, as any psychrophilic microorganisms present in the rock would have been severely damaged if the temperature of their environment had risen above 25°C; based on the temperature tape readings, we speculate that

this did not happen. At the same time, heating the drill water to >80°C would have effectively deactivated any potential psychrophilic microorganisms that inhabited the surface environment. The potential microbial contaminants in the drilling water could have been further reduced by filtering with 0.2 μm cartridge filters, but these were not deployed for fear that, if they clogged, the water supply would shut down quickly, the bit would freeze in the hole, and the drill water would also freeze.

Aqueous chemistry and stable isotopes

Based on isotopic analysis, the δ³⁷Cl vs. Cl results show that the bailed water was strongly enriched in chloride compared with the matrix fluid. It is clear that bailed-water δ³⁷Cl values are similar to those of the drill salt and are more negative than values for the most negative crush and leach fluid. We suspect that residual drill brine was pushed into fractures in the permafrost during the pre-drilling borehole flushing and during drilling. Once drilling ceased and the casing was installed, the briny drill fluid either flowed down the outside of the casing and into the borehole below or through poor seals between casing joints. One complicating factor is the number of boreholes drilled through lakes in the area. Some influence of the drill brine was seen in the surface water sampled in the area (Na vs. Ca plot). Chloride levels in the surface water were below δ³⁷Cl detection limits for the amount of water we collected. Stable isotopes of water (δ²H, δ¹⁸O) in bailed samples are similar to those found in Core Shed Lake (drill fluid).

One disturbing observation was that the saline water that replaced the drilling water was apparently residual drilling brine from drilling out the ice. This implies that, despite the 5 days of circulating fresh water in the 320 m deep borehole subsequent insertion of 320 m of casing after completion of the drilling, some drilling brine leaked out of the rock formation and flowed down between the rock strata and the casing to fill the borehole. If heated fresh water had been used during the drilling of the old borehole, such cross contamination between layers would likely not have occurred, as the fresh water would form an icy zone around the borehole.

FIG. 9. Examination of fluorescent microsphere tracers on core chip. Digital photographs (A, C) of a core chip sample (403 m). (A) Intact; (C) Fractured. Image (B) of green fluorescent microspheres located in a field of view in the dotted-line area on photograph (A), obtained at 100× total magnification with ASI Spectral Microscopy system (excitation: 487–507 nm; emission: 514–550 nm). Composite image (D) of fluorescent microspheres (green dots; excitation: 487–507 nm; emission: 514–550 nm) and rock material (in white, obtained under bright-field exposure) located in a field of view in the dotted-line area on photograph (C) (on the edge of the fracture), obtained at 100× total magnification with ASI Spectral Microscopy system. Images (B) and (D) show extensive attachment of microspheres at the surface of the core sample, while image (D) specifically shows the absence of microspheres beyond the fracture line.

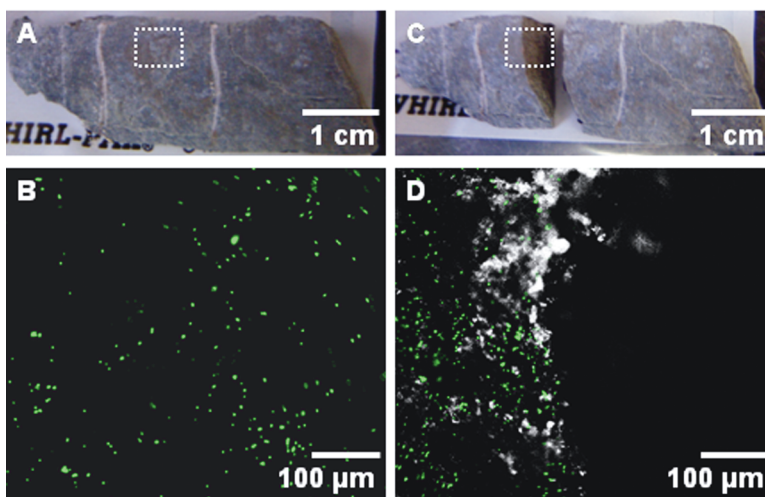

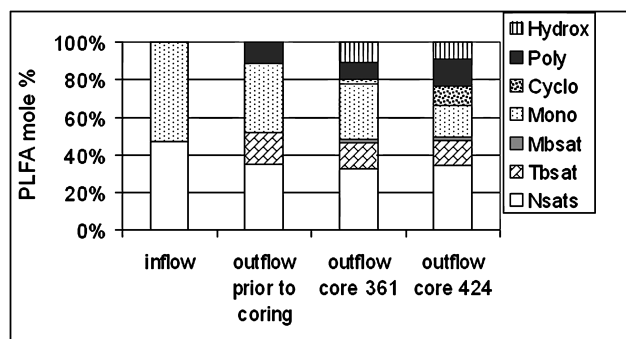

FIG. 10. PLFA profile for drill-water samples. PLFA profiles as represented as the mole percent of lipids classes. The profiles are shown for drill-water samples with detectable biomass. Lipid classes are designated as Nsats, normal saturates; Tbsat, terminally branched saturates; Mbsat, mid-chain-branched saturates; Mono, monounsaturates; Cyclo, cyclopropyl fatty acids; Poly, polyunsaturates; Hydrox, hydroxyl fatty acids.

Perfluorocarbon and microsphere tracers

Perfluorocarbon tracers indicated that minimal contamination of the rock cores occurred from the drill water. In reviewing field sampling procedures, the paring and inner rock samples collected for PFT analyses were performed in the glove bag during the core splitting for a variety of investigators. During the collection of these PFT samples, the samples may have been handled in such a way as to transfer PFT to the surface of freshly pared cores. Likewise, atmosphere samples from the glove bag for PFT analyses were not collected. The PFT samples from the injection line indicated increased PFT concentrations, following the daily addition of freshly made PFT solution to the feed stock line. The combination of daily increases in PFT concentrations, followed by decreased PFT concentration over time due to

possible volatilization, complicated the interpretation of the PFT data. Regardless, the 3 orders of magnitude difference between inner cores and parings is significant; and with modified sampling procedure, future results would be more definitive.

As an excellent QA/QC standard practice, a secondary tracer was used. A clear indication of the lack of contamination to the inner core was shown by the microsphere data, which demonstrates that no penetration of microspheres into the core interior occurred. These results correspond with the rock pore size data and the fracture frequency data that indicate tight fractures with respect to water flow.

PLFA analysis

The biodensity estimates for the surface-sterilized cores at High Lake are lower than estimates for deep subsurface cores from the sandstones and shales in Colorado and Virginia (<17 pmol PLFA g^{-1}) and quartzite and carbon leader rock cores in South Africa (0.7 – 81 pmol g^{-1}) (Colwell *et al.*, 1997; Onstott *et al.*, 1998, 2003). The biodensity estimates for the drill-water samples reveal that 4 out of 10 samples had detectable biomass (24 – 595 pmol ml^{-1}). It is highly unusual that biomass was not detected in 6 of the drill-water samples. This contrasts with previous studies, where drilling muds always yielded PLFA concentrations with 2 – 80 PLFA pmol ml^{-1} in South African mine drilling fluids, 188 pmol ml^{-1} in Virginia drilling fluids, and >3000 pmol ml^{-1} in Colorado drilling fluids (Colwell *et al.*, 1997; Onstott *et al.*, 1998, 2003). It may reflect the fact that the drilling water was not circulated but was pumped to a sump pond after one pass through the drill string. Of these samples, only 2 drill-water outflow samples represented diverse microbial communities. The inflow drill water and the outflow drill water prior to coring had profiles of normal saturated and monounsaturated fatty acids. Normal saturated fatty acids are ubiquitous and are not representative of specific microbial populations, whereas the monounsaturated fatty acids indicate

TABLE 1. IDENTIFICATION OF AEROBIC HETEROTROPHS FROM HIGH LAKE ROCK CORES

| Sample depth (m) | No. of isolates | Nearest neighbor (from the Ribosomal Database Project II SeqMatch) | Similarity score |
|-----------------------------|-----------------|--|------------------|
| Interior Isolates | | | |
| 342 | 2 | <i>Pseudomonas</i> sp. AEBL3 | 1.000 |
| 425 | 1 | <i>Massilia aurea</i> ; type strain: AP13 | 0.999 |
| 425 | 1 | <i>Pseudomonas trivialis</i> | 1.000 |
| 487 | 1 | <i>Pseudomonas amygdali</i> | 0.980 |
| 487 | 5 | <i>Pseudomonas</i> sp. An23 | 1.000 |
| Surface Contaminants | | | |
| 342 | 1 | <i>Pseudomonas reactans</i> | 0.999 |
| 342 | 1 | <i>Pseudomonas</i> sp. DY02-3-4-242 | 0.907 |
| 361 | 1 | <i>Arthrobacter</i> sp. Amico5 | 0.884 |
| 361 | 1 | <i>Pseudomonas</i> sp. PM-2001 | 0.996 |
| 384 | 2 | <i>Microbacterium phyllosphaerae</i> (T) | 0.999 |
| 406 | 2 | <i>Arthrobacter</i> sp. Amico5 | 0.989 |
| 425 | 1 | <i>Pseudomonas synxantha</i> | 0.997 |
| 466 | 1 | <i>Arthrobacter</i> sp. Amico5 | 0.997 |
| 487 | 1 | <i>Flavobacterium</i> sp. WB 3.1-83 | 0.950 |
| 487 | 1 | <i>Pseudomonas</i> sp. DVS14a | 0.913 |

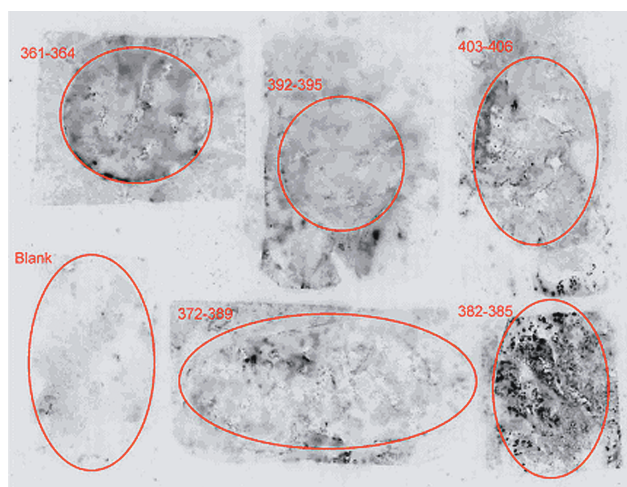

FIG. 11. ^{35}S phosphor images of Ag foils measured after ~ 120 days of incubation at 4°C . Circles and ellipses demarcate the edge of the cores. Black areas indicate areas of higher activity.

Gram-negative bacteria. The 2 samples with PLFA diversity showed increases in terminally branched and mid-chain-branched saturates, polyunsaturates, and cyclopropyl and hydroxyl fatty acids. Terminally branched saturates are indicative of Gram-positive bacteria and some anaerobic Gram-negative bacteria. The mid-chain-branched saturates are associated with metal- or sulfate-reducing bacteria. The cyclopropyl fatty acids may indicate sulfate-reducing bacteria and other anaerobic prokaryotes (Tunlid and White, 1992). The detection of sulfate-reducer PLFA signatures is supported by the cultivation assay and the $^{35}\text{SO}_4$ microautoradiography results.

Another consideration is that the cyclopropyl fatty acids are also related to physiological status, as seen in late log phase cells or those that are maintaining cell wall integrity rather than replicating. Polyunsaturates generally indicate the influences of microeukaryotes. Hydroxy fatty acids are associated with the Gram-negative bacteria. The fatty acids detected in the 2 drill waters may have resulted from drilling through core that contained a microbial microniche (Colwell *et al.*, 1997); due to this heterogeneity, the portion of the core analyzed for PLFA did not contain a detectable microbial microniche.

Although the biodensity of the drill water was low and the PFTs indicated that minimal contamination of the rock cores occurred from the drill water, the microsphere data and the PLFA sterilization procedure demonstrate that significant contamination existed on the core surface. If this contamination was from the drill string, the signature PLFAs would have been consistent across all samples. Since this was not the case, the presence of microniches that were drilling through within the 3 m core is more probable. Characterizing the microbial community within the rock cores without cross contamination from the outer surface of the core will be a difficult task because of their very low microbial biomass as witnessed by the PLFA concentrations. Molecular analysis of subsurface rock is difficult because of the low biomass, especially if there is a high degree of heterogeneity (Ogram *et al.*, 1995; Reed *et al.*, 2002). Preliminary results from

analyses indicate that the biomass was below the detection level of standard PCR, and a multiple displacement amplification method (Abulencia *et al.*, 2006) will have to be employed to characterize the rock-bound biota. Lipid analysis remains a reliable method by which to describe the cultivable and uncultivable microbial community in low-biomass samples (Tunlid *et al.*, 1989; Green and Scow, 2000).

Microbial cultivation assays

We attempted to isolate aerobic heterotrophs from the interior of samples by sterilizing the outer surface prior to splitting cores in half and by culturing organisms only from the freshly fractured surface. Surface sterilization techniques were successful; no growth was observed on control plates. One core (361) harbored no culturable organisms; no isolates were obtained from the interior, though abundant surface contamination was present prior to sterilization of the outer surface. Three other cores may have been "sterile" due to inhibitory compounds present in the rock. In contrast, isolates were successfully obtained from the interior of 6 other cores. Of the isolates from the interior, none had sequences identical to any of the surface contaminants; however, some common genera were observed. Interestingly, several different cores had surface contaminants that were closely related to the same organism (*Arthrobacter* sp. Amico5), which indicates that the source of surface contaminants was similar for all samples. The variety of common soil bacteria found in the High Lake samples represented the following 5 genera *Pseudomonas*, *Arthrobacter*, *Flavobacterium*, *Massilia*, and *Microbacterium*. The genera *Arthrobacter* and *Microbacterium* were the only genera similar between High Lake and Siberian permafrost (Bakermans *et al.*, 2003). The other genera recovered from the Siberian site included *Bacillus*, *Subtercola*, *Rhodococcus*, *Erwinia*, *Psychrobacteria*, *Frigoribacterium*, and *Paenibacillus*, with the last 3 genera as known psychrotolerant strains (Bakermans *et al.*, 2003).

$^{35}\text{SO}_4$ microautoradiography

The $^{35}\text{SO}_4$ microautoradiography recorded a 100-fold range of activity and, hence, potential cultivability in the core samples. Sulfate reducers were cultivated from 1 core that showed the most sulfate reduction by microautoradiography. The $^{35}\text{SO}_4$ microautoradiography data suggest that an indigenous microbial component exists in the permafrost rock at this site, and the phosphor images will be used to select samples for DNA extraction and amplification.

Considerations for future drilling activities

Several subsurface microbiology studies used larger-diameter cores that were pared to reduce surface contamination and the potential for exposure of the inner core to drilling artifacts, drilling fluids, and extraneous gas phases (Balkwill *et al.*, 1989; Colwell *et al.*, 1992; Onstott *et al.*, 1994, 1998, 2003; Kieft *et al.*, 1995; McKinley and Colwell, 1996). With anticipated drilling on Mars, Zacny and Cooper (2005) discussed strategies founded on drilling bits that are based on rock or soil type, auger methods, cuttings removal, the presence of ice or liquid water, and power requirements. The auger size used was 39 mm (Zacny *et al.*, 2004), which is considered smaller than augers used for deep subsurface sam-

pling. Christner *et al.* (2005) described decontamination protocols for extraterrestrial samples, but these are designed around 10 mm diameter ice core samples. The decontamination procedures for sediment and rock core in some cases are similar, yet the implementation of the procedure is quite different (*i.e.*, paring a sediment or rock sample cannot be easily done with a band saw without significantly heating the sample). Furthermore, Mars near-surface drilling prototypes (0–50 m) being tested have significantly smaller core sizes (2 cm) (Briggs *et al.*, 2003; Glass *et al.*, 2008). Throughout these studies, monitoring of core temperature and tracer infiltration into the core have not been addressed. Thus, for successful core recovery for biological and chemical interrogation from the deep subsurface of Mars, the size of the core to be recovered, monitoring of temperature and other physical parameters that may alter the sample, and the use of rigorous QA/QC warrants additional consideration.

Stringent drilling procedures coupled with rigorous QA/QC procedures in our investigation enabled interpretation of the chloride as having originated from previous drilling activities at shallower depths. Similarly, coring in other extreme environments with varied lithologies could also result in differential solute dissolution and compromise well-bore groundwater chemistries at greater depth. Less rigorous procedures or controls could lead to erroneous interpretations of *in situ* conditions. Erroneous groundwater chemistries could result in altered drilling practices or changes in drilling fluid formulations that could then be deleterious to borehole stability, particularly in zones that contain clathrates. For example, excess brine in drilling fluids could contribute to the destabilization of methane clathrates and result in methane off-gassing, alteration of groundwater chemistries, or explosive hazards (Madden *et al.*, 2007).

The impacts of temperature and related issues of moisture in permafrost and deeper zones will prove challenging in future investigations on Earth and Mars. The observation that moisture condensation more than 100 m below land surface resulted in the closure of the well bore and the loss of sampling tools has profound implications for remotely operated drilling operations where very limited operational observations and controls are available. In this case, calculations of vapor transport rates clearly indicate that the condensation originated from atmospheric humidity that convectively entered the borehole, where it was cold trapped. For smaller-diameter boreholes envisioned for martian deep-drilling missions, this may become an issue despite the low atmospheric humidity. More importantly, the moisture released from drilling ice-saturated rock will migrate up the borehole and quickly condense on the borehole surfaces. It seems that any coring or drilling technology proposed for Mars must incorporate a means by which to heat the borehole environment behind the bottom-hole assembly to avoid ice plugging.

Conclusion

In summary, the High Lake expedition provided an excellent test bed and experience for coring deep permafrost environments and for developing QA/QC procedures that improve avoidance and mitigation procedures. As more experience is gained with cold-climate and remotely operated

drilling operations, it is certain that further refinements and development of procedures will facilitate successful expeditions on Earth and Mars.

This drilling activity was only the first phase of the study, with future activities to include installation of a packer with sensors, a water-sampling device, and a means by which to introduce gaseous substrates for the stimulation of methanogenic activity within the borehole environment.

Acknowledgments

This research was supported by a NASA Astrobiology Institute grant to Prof. L.M. Pratt of Indiana University. We are indebted to the mine staff at High Lake and to Norm Case of Discovery Mining Services for providing supply transport and logistics.

Abbreviations

GC, gas chromatograph; GC/MS, gas chromatography/mass spectrometry; PDMCH, perfluorodimethylcyclohexane; PFTs, perfluorocarbon tracers; PLFAs, phospholipid fatty acids; PMCH, perfluoromethylcyclohexane; PTYG, peptone, tryptone, yeast extract, and glucose; QA/QC, quality assurances and quality controls.

References

- Abulencia, C.B., Wyborski, D.L., Garcia, J.A., Podar, M., Chen, W., Chang, S.H., Chang, H.W., Watson, D., Brodie, E.L., Hazen, T.C., and Keller, M. (2006) Environmental whole-genome amplification to access microbial populations in contaminated sediments. *Appl. Environ. Microbiol.* 72:3291–3301.
- Bakermans, C., Tsapin, A.I., Souza-Egipsy, V., Gilichinsky, D.A., and Nealon, K.H. (2003) Reproduction and metabolism at -10°C of bacteria isolated from Siberian permafrost. *Environ. Microbiol.* 5:321–326.
- Balkwill, D.L., Leach, F.R., Wilson, J.T., McNabb, J.F., and White, D.C. (1988) Equivalence of microbial biomass measures based on membrane lipid and cell wall components, adenosine triphosphate, and direct counts in subsurface sediments. *Microb. Ecol.* 6:73–84.
- Balkwill, D.L., Fredrickson, J.K., and Thomas, J.M. (1989) Vertical and horizontal variations in the physiological diversity of the aerobic chemoheterotrophic bacterial microflora in deep southeast coastal plain subsurface sediments. *Appl. Environ. Microbiol.* 55:1058–1065.
- Biggerstaff, J.P., Le Puil, M., Weidow, B.L., Leblanc-Gridley, J., Jennings, E.M., Busch-Harris, J., Sublette, K.L., White, D.C., and Alberte, R.S. (2006) A novel and *in situ* technique for the quantitative detection of MTBE and benzene degrading bacteria in contaminated matrices. *J. Microbiol. Methods* 68: 437–441.
- Bligh, E.G. and Dyer, W.J. (1959) A rapid method of total lipid extraction and purification. *Can. J. Biochem. Physiol.* 37:911–917.
- Briggs, G.A., McKay, C., George, J., Derkowski, G., Cooper, G., Zacny, K., Fincher, R., Pollard, W., and Clifford, S. (2003) An automated, low mass, low power drill for acquiring subsurface samples of ground ice for astrobiology studies on Earth and on Mars [abstract 8018]. In *3rd International Conference on Mars Polar Science and Exploration, 13–17 October, Baniff, Alberta, Canada*.
- Chang, Y.C., Le Puil, M., Biggerstaff, J.P., Randall, A.A., Schulte, A., and Taylor, J.S. (2003) Direct estimation of biofilm density

- on different pipe material coupons using a specific DNA-probe. *Mol. Cell. Probes* 17:237–243.
- Chapelle, F.H., and McMahon, P.B. (1991) Geochemistry of dissolved inorganic carbon in a coastal plain aquifer. 1. Sulfate from confining beads as an oxidant in microbial CO₂ production. *Journal of Hydrology* 127:85–108.
- Christner, B.C., Mikucki, J.A., Foreman, C.M., Denson J., and Priscu, J.C. (2005) Glacial ice cores: a model system for developing extraterrestrial decontamination protocols. *Icarus* 174:572–584.
- Colwell, F.S., Stormberg, G.J., Phelps, T.J., Birnbaum, S.A., McKinley, J., and Rawson, S.A. (1992) Innovative techniques for collection of saturated and unsaturated basalts and sediments for microbiological characterization. *J. Microbiol. Methods* 15:279–292.
- Colwell, F.S., Onstott, T.C., Delwiche, M.E., Chandler, D., Fredrickson, J.K., Yao, Q.J., McKinley, J.P., Boone, D., Griffiths, R., Phelps, T.J., Ringelberg, D., White, D.C., LaFreniere, L., Balkwill, D., Lehman, R.M., Konisky, J., and Long, P.E. (1997) Microorganisms from deep high temperature sandstones: constraints on microbial colonization. *FEMS Microbiol. Rev.* 20:425–436.
- Craig, H. (1961) Isotopic variations in meteoric waters. *Science* 133:1702–1703.
- DeVincenzi, D.L., Race, M.S., and Kein, H.P. (1998) Planetary protection, sample return missions and Mars exploration: history, status and future needs. *J. Geophys. Res.* 103:28577–28585.
- Epstein, S. and Mayeda, T.K. (1953) Variations of the ¹⁸O/¹⁶O ratio in natural waters. *Geochim. Cosmochim. Acta* 50: 1561–1563.
- Fredrickson, J.K., Brockman, F.J., Bjornstad, B.N., Long, P.E., Li, S.W., McKinley, J.P., Wright, J.V., Conca, J.L., Kieft, T.L., and Balkwill, D.L. (1993) Microbiological characterization of pristine and contaminated deep vadose sediments from an arid region. *Geomicrobiol. J.* 11:95–107.
- Freed, R., Dickin, R., Mayer, U., and Mitchell, A. (2007) Effect of saline groundwater on migration of trace metal contaminants, high lake mine. Nunavut. In *OttawaGeo 2007*, Ottawa, Canada.
- Freifeld, B.M., Trautz, R.C., Kharaka, Y.K., Phelps, T.J., Myer, L.R., Hovorka, S.D., and Collins, D.J. (2005) The U-tube: a novel system for acquiring borehole fluid samples from a deep geologic CO₂ sequestration experiment. *J. Geophys. Res.* 110, doi:10.1029/2005JB003735.
- Gilichinsky, D.A., Wilson, G.S., Friedmann, E.I., McKay, C.P., Sletten, R.S., Rivkina, E.M., Vishnivetskaya, T.A., Erokhina, L.G., Ivanushkina, N.E., Kochkina, G.A., Shcherbakova, V.A., Soina, V.S., Spirina, E.V., Vorobyova, E.A., Fyodorov-Davydov, D.G., Hallet, B., Ozerskaya, S.M., Sorokovikov, V.A., Laurinavichyus, K.S., Shatilovich, A.V., Chanton, J.P., Ostroumov, V.E., and Tiedje, J.M. (2007) Microbial populations in antarctic permafrost: biodiversity, state, age, and implication for astrobiology. *Astrobiology* 7:275–311.
- Glass, B., Cannon, H., Branson, M., Hanagud, S., and Paulsen, G. (2008) DAME: planetary-prototype drilling automation. *Astrobiology* 8:653–664.
- Green, C.T. and Scow, K.M. (2000) Analysis of phospholipid fatty acids (PLFA) to characterize microbial communities in aquifers. *Hydrogeology Journal* 8:126–141.
- Griffin, W.T., Phelps, T.J., Colwell, F.S., and Fredrickson, J.K. (1997) Methods for obtaining deep subsurface microbiological samples by drilling. In *Methods for Obtaining Deep Subsurface Microbiological Samples by Drilling*, edited by P.S. Amy and D.L. Haldeman, Lewis Publishers, Boca Raton, FL, pp 23–44.
- Guckert, J.B., Antworth, C.P., Nichols, P.D., and White, D.C. (1985) Phospholipid, ester-linked fatty acid profiles as reproducible assays for changes in prokaryotic community structure of estuarine sediments. *FEMS Microbiol. Ecol.* 31:147–158.
- Harvey, R.W., George, L.H., Smith, R.L., and LeBlanc, D.R. (1989) Transport microspheres and indigenous bacteria through a sandy aquifer. Results of natural- and forced-gradient tracer experiments. *Environ. Sci. Technol.* 23:51–56.
- Henderson, J.R., Henderson, M.N., Kerswill, J.A. and Dehls, J.F. (2000) Geology, High Lake greenstone belt, Nunavut. In *Geological Survey of Canada, Map 1945A, scale 1:100 000*, Geological Survey of Canada, Ottawa, Canada.
- Juck, D.F., Whissell, G., Steven, B., Pollard, W., McKay, C.P., Greer, C.W., and Whyte, L.G. (2005) Utilization of fluorescent microspheres and a green fluorescent protein-marked strain for assessment of microbiological contamination of permafrost and ground ice core samples from the Canadian High Arctic. *Appl. Environ. Microbiol.* 71:1035–1041.
- Kallmeyer, J., Ferdelman, T.G., Weber, A., Fossing, H., and Jørgensen, B.B. (2004) A cold chromium distillation procedure for radiolabeled sulfide applied to sulfate reduction measurements. *Limnology and Oceanography: Methods* 2:171–180.
- Kaufmann, R.S., Long, A., Bentley, H., and Davis, S. (1984) Natural variation of chlorine stable isotopes. *Nature* 309:338–340.
- Kieft, T.L., Fredrickson, J.K., McKinley, J.P., Bjornstad, B.N., Rawson, S.A., Phelps, T.J., Brockman, F.J., and Pfiffner, S.M. (1995) Microbiological comparisons within and across contiguous lacustrine, paleosol, and fluvial subsurface sediment. *Appl. Environ. Microbiol.* 61:749–757.
- Krumholz, L.R., McKinley, J.P., Ulrich, G.A., and Suflita, J.M. (1997) Confined subsurface microbial communities in Cretaceous rock. *Nature* 386:64–66.
- Lagomarsino, R.J. (1996) An improved gas chromatographic method for the determination of perfluorocarbon tracers in the atmosphere. *J. Chromatogr. Sci.* 34:405–412.
- Le Puil, M., Biggerstaff, J.P., Weidow, B.L., Price, J.R., Naser, S.A., White, D.C., and Alberte, R.S. (2006) A novel fluorescence imaging technique combining deconvolution microscopy and spectral analysis for quantitative detection of opportunistic pathogens. *J. Microbiol. Methods* 67:597–602.
- Madden, M.E.E., Ulrich, S.M., Onstott, T.C., and Phelps, T.J. (2007) Salinity-induced hydrate dissociation: a mechanism for recent CH₄ release on Mars. *Geophys. Res. Lett.* 34:L11202, doi:10.1029/2006 GL029156.
- Mancinelli, R.L. (2000) Accessing the martian deep subsurface to search for life. *Planet. Space Sci.* 48:1035–1042.
- McKinley, J.P. and Colwell, F.S. (1996) Application of perfluorocarbon tracers to microbial sampling in sub-surface environments using mud-rotary and air-rotary drilling techniques. *J. Microbiol. Methods* 26:1–9.
- Morrison, J., Brockwell, T., Merren, T., Fourel, F., and Phillips, A.M. (2001) On-line high-precision stable hydrogen isotopic analyses on nanoliter water samples. *Anal. Chem.* 73:3570–3575.
- Moser, D.P., Gihring, T., Fredrickson, J.K., Brockman, F.J., Balkwill, D., Dollhopf, M.E., Sherwood Lollar, B., Pratt, L.M., Boice, E., Southam, G., Wanger, G., Welty, A.T., Baker, B.J., and Onstott, T.C. (2005) *Desulfotomaculum* spp. and *Methanobacterium* spp. dominate 4–5 km deep fault. *Appl. Environ. Microbiol.* 71:8773–8783.
- Ogram, A., Sun, W., Brockman, F.J., and Fredrickson, J.K. (1995) Isolation and characterization of RNA from low-biomass deep-subsurface sediments. *Appl. Environ. Microbiol.* 61:763–768.
- Onstott, T.C., Balkwill, D.L., Boone, D.R., Caldwell, F.S., Griffin, T., Kieft, T.L., Lehman, R.M., McKinley, J.P., Nierzwicki-Bauer, S., Tseng, H.Y., Gao, G., Phelps, T.J., Ringelberg, D.,

- Russel, B., Stevens, T.O., White, D.C., and Wobber, F.J. (1994) DOE seeks origin of deep subsurface bacteria. *Eos* 75:385–395.
- Onstott, T.C., Phelps, T.J., Colwell, F.S., Ringelberg, D., White, D.C., and Boone, D. (1998) Observations pertaining to the origin and ecology of microorganisms recovered from the deep subsurface of Taylorsville Basin, Virginia. *Geomicrobiol. J.* 15:353–385.
- Onstott, T.C., Moser, D.P., Fredrickson, J.K., Brockman, F.J., Pfiffner, S.M., Phelps, T.J., White, D.C., Peacock, A., Balkwill, D., Hoover, R., Krumholz, L.R., Borscik, M., Kieft, T.L., and Wilson, R.B. (2003) Indigenous versus contaminant microbes in ultradeep mines. *Environ. Microbiol.* 5:1168–1191.
- Onstott, T.C., Lin, L.-H., Davidson, M., Mislowack, B., Borscik, M., Hall, J., Slater, G., Ward, J., Sherwood Lollar, B., Lippmann-Pipke, J., Boice, E., Pratt, L.M., Pfiffner, S., Moser, D.P., Gihring, T., Kieft, T., Phelps, T.J., van Heerden, E., Litthaur, D., DeFlaun, M., and Rothmel, R. (2005) The origin and age of biogeochemical trends in deep fracture water of the Witwatersrand Basin, South Africa. *Geomicrobiol. J.* 23:369–414.
- Petch, C.A. (2004) The geology and mineralization of the High Lake volcanic-hosted massive sulfide deposit, Nunavut. *Exploration and Mining Geology* 13:37–47.
- Pfiffner, S.M., Cantu, J.M., Smithgall, A., Peacock, A.D., White, D.C., Moser, D.P., Onstott, T.C., and van Heerden, E. (2006) Deep subsurface microbial biomass and community structure in Witwatersrand Basin mines. *Geomicrobiol. J.* 23:431–442.
- Phelps, T.J., Pfiffner, S.M., Sargent, K.A., and White, D.C. (1994) Factors influencing the abundance and metabolic capacities of microorganisms in eastern coastal plain sediments. *Microb. Ecol.* 28:351–364.
- Phelps, T.J. and Fredrickson, J.K. (2001) Drilling, coring and sampling subsurface environments. In *Manual of Environmental Microbiology*, edited by C.J. Hurst, ASM Press, Washington, DC, pp 679–696.
- Reed, D.W., Fujita, Y., Delwiche, M.E., Blackwelder, D.B., Sheridan, P.P., Uchida, T., and Colwell, F.S. (2002) Microbial communities from methane hydrate-bearing deep marine sediments in a forearc basin. *Appl. Environ. Microbiol.* 68:3759–3770.
- Russell, B.F., Phelps, T.J., Griffin, W.T., and Sargent, K.A. (1992) Procedures for sampling deep subsurface microbial communities in unconsolidated sediments. *Ground Water Monitor Rev.* 12:96–104.
- Senum, G.I. and Dietz, R.N. (1991) Perfluorocarbon tracer tagging of drilling muds for the assessment of sample contamination. In *Perfluorocarbon Tracer Tagging of Drilling Muds for the Assessment of Sample Contamination*, edited by C.B. Fliermans and T.C. Hazen, Westinghouse Savannah River Co. Information Service Section Publications Group, Aiken, SC, pp 7/145–7/158.
- Smith, D.C., Spivack, A.J., Fisk, M.R., Haveman, S.A., and Staudigel, H. (2000) Tracer based estimates of drilling-induced microbial contamination of deep sea crust. *Geomicrobiol. J.* 17:207–219.
- Smith, H.D. and McKay, C.P. (2005) Drilling in ancient permafrost on Mars for evidence of a second genesis of life. *Planet. Space Sci.* 53:1302–1308.
- Steven, B., Briggs, G., McKay, C.P., Pollard, W.H., Greer, C., and Whyte, L.G. (2007) Characterization of the microbial diversity in a permafrost sample from the Canadian High Arctic using culture-dependent and culture-independent methods. *FEMS Microbiol. Ecol.* 59:513–523.
- Taylor, J.W. and Grimsrud, E.P. (1969) Chlorine isotope ratio by negative ion mass spectrometer. *Anal. Chem.* 41:805–810.
- Tunlid, A., Ringelberg, D., Low, C., Phelps, T.J., and White, D.C. (1989) Analysis of phospholipid fatty acids from bacteria at picomolar sensitivities from environmental samples. *J. Microbiol. Methods* 10:139–153.
- Tunlid, A. and White, D.C. (1992) Biochemical analysis of biomass, community structure, nutritional status and metabolic activity of microbial communities in soil. In *Soil Biochemistry*, Vol. 7, edited by G. Stotzky and J.-M. Bollag. Marcel-Dekker, New York, pp 229–262.
- White, D.C., Davis, W.M., Nickels, J.S., King, J.D., and Bobbie, R.J. (1979) Determination of the sedimentary microbial biomass by extractable lipid phosphate. *Oecologia* 40:51–62.
- White, D.C. and Ringelberg, D. (1998) Signature lipid biomarker analysis. In *Techniques in Microbial Ecology*, edited by R.S. Burlage, R. Atlas, D.A. Stahl, G. Geesey, and G. Saylor, Oxford University Press, New York, pp 255–272.
- Zacny, K.A., Quayle, M.C., and Cooper, G.A. (2004) Laboratory drilling under martian conditions yields unexpected results. *J. Geophys. Res.* 109, doi:10.1029/2003JE002203.
- Zacny, K.A. and Cooper, G.A. (2005) Investigation of the performance of a coring bit in frozen mud under martian conditions of low temperature and pressure. *J. Geophys. Res.* 110, doi:10.1029/2004JE002341.
- Zacny, K. and Cooper, G. (2006) Considerations, constraints and strategies for drilling on Mars. *Planet. Space Sci.* 54:345–356.
- Zacny, K., Bar-Cohen, Y., Brennan, M., Briggs, G., Cooper, G., Davis, K., Dolgin, B., Glaser, D., Glass, B., Gorevan S., Guerrero, J., McKay, C., Paulsen, G., Stanley, S., and Stoker, C. (2008) Drilling systems for extraterrestrial subsurface exploration. *Astrobiology* 8:665–706.

Address reprint requests to:

S.M. Pfiffner

The University of Tennessee

Center for Environmental Biotechnology

10515 Research Drive, Suite 300

Knoxville, Tennessee 37932

E-mail: pfiffner@utk.edu