

Construction of Low-Cracking High-Performance Bridge Decks Incorporating New Technology Phase II

Alireza Bahadori
David Darwin, Ph.D., P.E.
Matthew O'Reilly, Ph.D., P.E.
Mohsen Salavati Khoshghalb

The University of Kansas

A Transportation Pooled Fund Study - TPF-5(392)

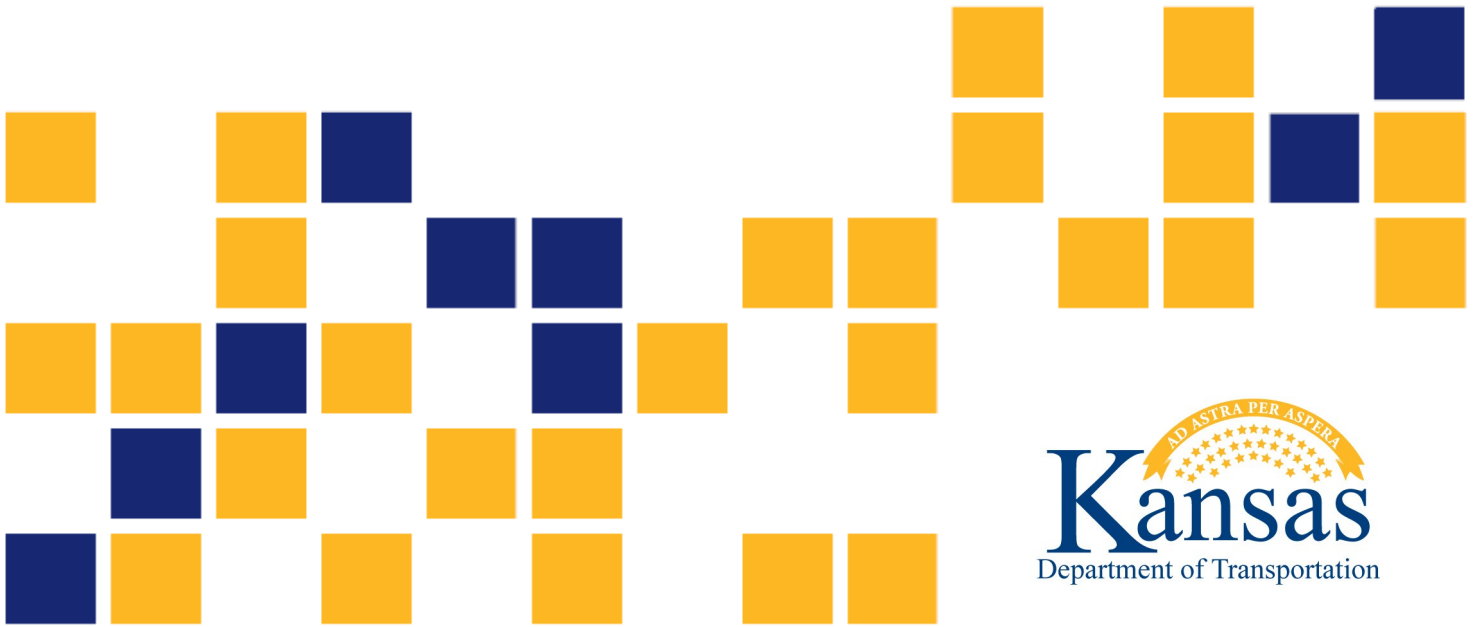

1 Report No. FHWA-KS-23-02	2 Government Accession No.	3 Recipient Catalog No.	
4 Title and Subtitle Construction of Low-Cracking High-Performance Bridge Decks Incorporating New Technology Phase II		5 Report Date December 2023	6 Performing Organization Code
		8 Performing Organization Report No. SM 157	
7 Author(s) Alireza Bahadori David Darwin, Ph.D., P.E. Matthew O'Reilly, Ph.D., P.E. Mohsen Salavati Khoshghalb		10 Work Unit No. (TRAIS)	11 Contract or Grant No. C2138
9 Performing Organization Name and Address The University of Kansas Department of Civil, Environmental, & Architectural Engineering 1530 West 15th St Lawrence, KS 66045		13 Type of Report and Period Covered Final Report December 2021 – December 2023	
12 Sponsoring Agency Name and Address Kansas Department of Transportation Bureau of Research 2300 SW Van Buren Topeka, Kansas 66611-1195		14 Sponsoring Agency Code RE-0778-01 TPF-5 (392)	
15 Supplementary Notes For more information write to address in block 9. Pooled Fund Study TPF-5(392) sponsored by the following DOTs: Kansas and Minnesota.			
16 Abstract <p>The construction, crack surveys, and evaluation of 12 bridge decks with internal curing provided by prewetted fine lightweight aggregate and supplementary cementitious materials following internally cured low-cracking high-performance concrete (IC-LC-HPC) specifications of Minnesota or Kansas are described, as well as those from two associated Control decks without IC (MN-Control). Nine IC-LC-HPC decks and one Control deck were monolithic, while three IC-LC-HPC decks and one Control deck had an overlay. The internally cured low-cracking high-performance concrete had paste contents between 23.8 and 25.8 percent by volume. Of the 12 IC-LC-HPC decks, nine were constructed in Minnesota between 2016 and 2020, and three were constructed in Kansas between 2019 and 2021. The performance of the decks is compared with that of earlier IC-LC-HPC bridge decks and low-cracking high-performance concrete (LC-HPC) bridge decks without internal curing. The effects of construction practices on cracking are addressed. The results indicate that the use of overlays on bridge decks is not beneficial in mitigating cracking. The IC-LC-HPC decks constructed exhibited lower average crack densities than those without internal curing. Good construction practices are needed for low-cracking decks. If poor construction practices, which may include poor consolidation and disturbance of concrete after consolidation, over-finishing, delayed application of wet curing, are employed, even decks with low paste contents and internal curing can exhibit high cracking. Delayed curing and over-finishing can also result in scaling damage to bridge decks.</p>			
17 Key Words Bridge Decks, Construction Management, Cracking, Fracture Mechanics, Internal Curing, Internally Cured Low-Cracking High-Performance Concrete, High Performance Concrete, Lightweight Aggregate		18 Distribution Statement No restrictions. This document is available to the public through the National Technical Information Service www.ntis.gov .	
19 Security Classification (of this report) Unclassified	20 Security Classification (of this page) Unclassified	21 No. of pages 291	22 Price

This page intentionally left blank.

Construction of Low-Cracking High-Performance Bridge Decks Incorporating New Technology Phase II

Final Report

Prepared by

Alireza Bahadori
David Darwin, Ph.D., P.E.
Matthew O'Reilly, Ph.D., P.E.
Mohsen Salavati Khoshghalb

The University of Kansas

A Report on Research Sponsored by

THE KANSAS DEPARTMENT OF TRANSPORTATION
TOPEKA, KANSAS

and

THE UNIVERSITY OF KANSAS
LAWRENCE, KANSAS

December 2023

© Copyright 2023, **Kansas Department of Transportation**

NOTICE

The authors and the state of Kansas do not endorse products or manufacturers. Trade and manufacturers names appear herein solely because they are considered essential to the object of this report.

This information is available in alternative accessible formats. To obtain an alternative format, contact the Office of Public Affairs, Kansas Department of Transportation, 700 SW Harrison, 2nd Floor – West Wing, Topeka, Kansas 66603-3745 or phone (785) 296-3585 (Voice) (TDD).

DISCLAIMER

The contents of this report reflect the views of the authors who are responsible for the facts and accuracy of the data presented herein. The contents do not necessarily reflect the views or the policies of the state of Kansas. This report does not constitute a standard, specification or regulation.

Abstract

The construction, crack surveys, and evaluation of 12 bridge decks with internal curing provided by prewetted fine lightweight aggregate and supplementary cementitious materials following internally cured low-cracking high-performance concrete (IC-LC-HPC) specifications of Minnesota or Kansas are described, as well as those from two associated Control decks without IC (MN-Control). Nine IC-LC-HPC decks and one Control deck were monolithic, while three IC-LC-HPC decks and one Control deck had an overlay. The internally cured low-cracking high-performance concrete had paste contents between 23.8 and 25.8 percent by volume. Of the 12 IC-LC-HPC decks, nine were constructed in Minnesota between 2016 and 2020, and three were constructed in Kansas between 2019 and 2021. The performance of the decks is compared with that of earlier IC-LC-HPC bridge decks and low-cracking high-performance concrete (LC-HPC) bridge decks without internal curing. The effects of construction practices on cracking are addressed. The results indicate that the use of overlays on bridge decks is not beneficial in mitigating cracking. The IC-LC-HPC decks constructed exhibited lower average crack densities than those without internal curing. Good construction practices are needed for low-cracking decks. If poor construction practices, which may include poor consolidation and disturbance of concrete after consolidation, over-finishing, delayed application of wet curing, are employed, even decks with low paste contents and internal curing can exhibit high cracking. Delayed curing and over-finishing can also result in scaling damage to bridge decks.

Acknowledgements

Funding for this research was provided by the Kansas Department of Transportation (KDOT) and the Minnesota Department of Transportation (MnDOT) for the “Construction of Low-Cracking High-Performance Bridge Decks Incorporating New Technology” Transportation Pooled Fund Study, Project No. TPF-5(392).

Table of Contents

Abstract	v
Acknowledgements	vi
Table of Contents	vii
List of Tables	x
List of Figures	xii
Chapter 1 – Introduction	1
1.1 General	1
1.2 Previous Work	1
1.3 Internal Curing	3
1.4 Previous Work on the Effects of Paste Content and Internal Curing on Cracking of Bridge Decks	6
1.5 Objective and Scope	10
Chapter 2 – Construction of Internally Cured Low-Cracking High-Performance Concrete (IC- LC-HPC) and Control Bridge Decks in Minnesota and Kansas	11
2.1 General	11
2.2 MnDOT IC-LC-HPC Specifications	11
2.2.1 Aggregates	12
2.2.2 Concrete	14
2.2.3 Construction	15
2.3 Deck Construction-Minnesota	17
2.3.1 Concrete Mixture Proportions	19
2.4 Bridge Decks	22
2.4.1 MN-IC-LC-HPC-1	23
2.4.2 MN-Control-1	26
2.4.3 MN-IC-LC-HPC-2 – Deck with Overlay	28
2.4.4 MN-Control-2 – Deck with Overlay	33
2.4.5 MN-IC-LC-HPC-3 – Deck with Overlay	35
2.4.6 MN-IC-LC-HPC-4	39
2.4.7 MN-IC-LC-HPC-5	44
2.4.8 MN-IC-LC-HPC-6	53
2.4.9 MN-IC-LC-HPC-7	60

2.4.9.1 MN-IC-LC-HPC-7-P1	61
2.4.9.2 MN-IC-LC-HPC-7-P2	67
2.4.10 MN-IC-LC-HPC-8.....	70
2.4.11 MN-IC-LC-HPC-9.....	80
2.4.12 Failed MN-IC-LC-HPC Bridge Deck Placement in 2016.....	87
2.5 KDOT IC-LC-HPC Specifications.....	89
2.5.1 Aggregates	89
2.5.2 Concrete	90
2.5.3 Construction.....	92
2.6 Deck Construction-Kansas.....	93
2.6.1 Concrete Mixture Proportions	94
2.7 Bridge Decks	96
2.7.1 KS-IC-LC-HPC-1	96
2.7.2 KS-IC-LC-HPC-2.....	106
2.7.2.1 KS-IC-LC-HPC-2-P1.....	108
2.7.2.2 KS-IC-LC-HPC-2-P2.....	116
2.7.3 KS-IC-LC-HPC-3.....	122
Chapter 3 – Evaluation of Cracking Performance of Internally Cured Low-Cracking High- Performance Concrete (IC-LC-HPC) and Control Bridge Decks.....	132
3.1 General	132
3.2 Crack Survey Method.....	132
3.2.1 Crack Survey Procedure	132
3.2.2 Crack Width.....	134
3.3 Crack Surveys and Results	134
3.3.1 Minnesota Bridge Deck Crack Survey Results	134
3.3.1.1 MN-IC-LC-HPC-1	135
3.3.1.2 MN-Control-1	138
3.3.1.3 MN-IC-LC-HPC-2 – Deck with Overlay.....	140
3.3.1.4 MN-Control-2 – Deck with Overlay	142
3.3.1.5 MN-IC-LC-HPC-3 – Deck with Overlay.....	143
3.3.1.6 MN-IC-LC-HPC-4.....	144
3.3.1.7 MN-IC-LC-HPC-5.....	146
3.3.1.8 MN-IC-LC-HPC-6.....	149

3.3.1.9 MN-IC-LC-HPC-7	152
3.3.1.10 MN-IC-LC-HPC-8	154
3.3.1.11 MN-IC-LC-HPC-9	156
3.3.2 Kansas Bridge Deck Crack Survey Results	159
3.3.2.1 KS-IC-LC-HPC-1	160
3.3.2.2 KS-IC-LC-HPC-2	163
3.3.2.3 KS-IC-LC-HPC-3	167
3.4 Cracking Performance of IC-LC-HPC Decks	169
3.4.1 Comparison with Kansas LC-HPC Decks	170
3.4.2 Comparison with Utah and Indiana Decks	171
Chapter 4 – Summary, Conclusions, and Recommendations	174
4.1 Summary	174
4.2 Conclusions	174
4.3 Recommendations	175
References	176
Appendix A: IC-LC-HPC Construction Evaluation Spreadsheet	183
Appendix B: Minnesota Department of Transportation Specifications for Internally Cured Low-Cracking High-Performance Concrete	186
Appendix C: Kansas Department of Transportation Specifications for Low-Cracking High- Performance Concrete (LC-HPC)-General, Aggregates, Concrete, and Construction	205
Appendix D: Previous Data for Evaluation of Cracking Performance of Bridge Decks in Chapter 3	264
Appendix E: Bridge Deck Survey Specifications	270

List of Tables

Table 2.1:	Requirements for Concrete in MnDOT IC-LC-HPC Decks	15
Table 2.2:	Required Curing Method based on Final Deck Surface (Minnesota Department of Transportation, 2018).....	16
Table 2.3:	MnDOT IC-LC-HPC and MN-Control Deck Information	17
Table 2.4:	MnDOT IC-LC-HPC and MN-Control Deck Geometry, Project Supplier, and Contractor	18
Table 2.5:	Cementitious Material Percentages and Aggregate Proportions (SSD/PSD Basis) ^a	19
Table 2.6:	LWA Properties, Design, and Actual Values Obtained by KU Researchers	20
Table 2.7:	Cementitious Material Content, Water Content, <i>w/cm</i> Ratio, Paste, and IC Water Contents for MnDOT IC-LC-HPC and MN-Control Decks ^a	21
Table 2.8:	Average MnDOT IC-LC-HPC and MN-Control Concrete Properties	22
Table 2.9:	MN-IC-LC-HPC-1 Mixture Proportions (SSD/PSD Basis).....	25
Table 2.10:	Concrete Test Results-MN-IC-LC-HPC-1	25
Table 2.11:	MN-Control-1 Mixture Proportions (SSD/PSD Basis)	27
Table 2.12:	Concrete Test Results-MN-Control-1	27
Table 2.13:	MN-IC-LC-HPC-2 Subdeck Mixture Proportions (SSD/PSD Basis)	30
Table 2.14:	Concrete Test Results-MN-IC-LC-HPC-2 Subdeck	30
Table 2.15:	MN-Control-2 Subdeck Mixture Proportions (SSD/PSD Basis)	34
Table 2.16:	Concrete Test results-MN-Control-2 Subdeck.....	34
Table 2.17:	MN-IC-LC-HPC-3 Subdeck Mixture Proportions (SSD/PSD Basis)	36
Table 2.18:	Concrete Test results-MN-IC-LC-HPC-3 Subdeck.....	37
Table 2.19:	MN-IC-LC-HPC-4 Mixture Proportions (SSD/PSD Basis).....	42
Table 2.20:	Average Concrete Test Results-MN-IC-LC-HPC-4	43
Table 2.21:	MN-IC-LC-HPC-5 Mixture Proportions (SSD/PSD Basis).....	48
Table 2.22:	Concrete Test Results-MN-IC-LC-HPC-5	48
Table 2.23:	MN-IC-LC-HPC-6 Mixture Proportions (SSD/PSD Basis).....	56
Table 2.24:	Concrete Test Results-MN-IC-LC-HPC-6	57
Table 2.25:	MN-IC-LC-HPC-7-P1 Mixture Proportions (SSD/PSD Basis)	63
Table 2.26:	Concrete Test Results-MN-IC-LC-HPC-7-P1	63
Table 2.27:	MN-IC-LC-HPC-7-P2 Mixture Proportions (SSD/PSD Basis)	69
Table 2.28:	Concrete Test Results ^a -MN-IC-LC-HPC-7-P2	69

Table 2.29: MN-IC-LC-HPC-8 Mixture Proportions (SSD/PSD Basis).....	74
Table 2.30: Concrete Test Results ^a -MN-IC-LC-HPC-8.....	75
Table 2.31: MN-IC-LC-HPC-9 Mixture Proportions (SSD/PSD Basis).....	82
Table 2.32: Concrete Test Results ^a -MN-IC-LC-HPC-9.....	83
Table 2.33: Requirements for Concrete in KDOT IC-LC-HPC Decks.....	91
Table 2.34: KDOT IC-LC-HPC Deck Information.....	93
Table 2.35: KDOT IC-LC-HPC Deck Geometry, Project Supplier, and Contractors.....	94
Table 2.36: Cementitious Material Percentages and Aggregate Proportions (SSD/PSD Basis) ^a	94
Table 2.37: Average LWA Properties, Design and Actual Values Obtained by KU Researchers.....	95
Table 2.38: Cementitious Material Content, Water Content, <i>w/cm</i> Ratio, Paste, and IC Water Contents for KDOT IC-LC-HPC Decks ^a	96
Table 2.39: Average KDOT IC-LC-HPC Concrete Properties.....	96
Table 2.40: KS-IC-LC-HPC-1 Mixture Proportions (SSD/PSD Basis).....	99
Table 2.41: Concrete Test Results-KS-IC-LC-HPC-1.....	100
Table 2.42: KS-IC-LC-HPC-2-P1 Mixture Proportions (SSD/PSD Basis).....	109
Table 2.43: Concrete Test Results ^a -KS-IC-LC-HPC-2-P1.....	110
Table 2.44: KS-IC-LC-HPC-2-P2 Mixture Proportions (SSD/PSD Basis).....	117
Table 2.45: Concrete Test Results ^a -KS-IC-LC-HPC-2-P2.....	118
Table 2.46: KS-IC-LC-HPC-3 Mixture Proportions (SSD/PSD Basis).....	126
Table 2.47: Concrete Test Results-KS-IC-LC-HPC-3.....	127

List of Figures

Figure 1.1: Crack Density Versus Age for Deck Panels in Kansas and Utah (Khajehdehi & Darwin, 2018)	7
Figure 1.2: Crack Density Versus Age for Indiana Decks (IC and Control) and Utah IC Decks (Lafikes et al., 2020).....	9
Figure 2.1: Centrifuge.....	13
Figure 2.2: Lightweight Aggregate Stockpile for MN-IC-LC-HPC-2	28
Figure 2.3: Finishing Equipment for MN-IC-LC-HPC-2 Subdeck	31
Figure 2.4: Water from Burlap Dripping onto the Deck.....	32
Figure 2.5: Walking through Freshly Consolidated Concrete	38
Figure 2.6: Water from Burlap Dripping onto the Deck (a) An Overview; (b) A Close-Up View	39
Figure 2.7: Disturbance of Concrete Observed Near the North End	44
Figure 2.8: Lightweight Aggregate Stockpile for MN-IC-LC-HPC-5	46
Figure 2.9: A Dense Clump of LWA Observed in the Stockpile for MN-IC-LC-HPC-5	46
Figure 2.10: Placement, Consolidation, and Finishing of MN-IC-LC-HPC-5	49
Figure 2.11: Holes in the Concrete Surface Due to Rapid Removal of the Spud Vibrator	50
Figure 2.12: Presence of Bleed Water on the Surface	51
Figure 2.13: Brooming of the Deck with the Presence of Excess Water at the Surface.....	52
Figure 2.14: The Application of the Curing Compound on the Bridge Deck	52
Figure 2.15: Burlap Placement on the Barrier Reinforcement	53
Figure 2.16: Lightweight Aggregate Stockpile for MN-IC-LC-HPC-6	54
Figure 2.17: Placing, Consolidation, and Finishing Equipment	58
Figure 2.18: Walking Through Consolidated Concrete.....	58
Figure 2.19: Tining of the Deck (a) An Overview; (b) A Close-Up View	59
Figure 2.20: The Application of the Curing Compound on the Roadway of the Deck Showing Uneven Coverage.....	60
Figure 2.21: MN-IC-LC-HPC-7 Lightweight Aggregate Stockpile	61
Figure 2.22: Placement Equipment.....	64
Figure 2.23: Walking Observed on Freshly Consolidated Concrete	65
Figure 2.24: Bull Floating the Deck in the Presence of Bleed Water (a) An Overview; (b) A Close-Up View	66
Figure 2.25: The Application of Curing on MN-IC-LC-HPC-7-P1	67

Figure 2.26: The Appearance of Air Pockets on the Concrete Surface (Image Provided by MnDOT).....	72
Figure 2.27: Placement of Second Truckload in Second Trial Placement (Containing Set Retarding Admixture) with No Observable Air Pockets on the Concrete Surface.....	73
Figure 2.28: Small, Trapped Air Pockets at Edges of Third Trial Placement (a) Overview; (b) Close-Up (Image Provided by MnDOT).....	73
Figure 2.29: Finishing Equipment	76
Figure 2.30: Trapped Air Pockets on Top of the East End Abutment (a) Overview; (b) Close-Up (Image Provided by MnDOT).....	77
Figure 2.31: Tining the Deck Before Application of Curing Compound.....	78
Figure 2.32: Non-Uniform Distribution of Curing Compound on the Deck.....	78
Figure 2.33: Burlap Placement on the Barrier Reinforcement	79
Figure 2.34: Covering the Deck with Wet Burlap and Plastic Sheeting.....	79
Figure 2.35: Disturbance of the Bottom of the Stockpile	81
Figure 2.36: MN-IC-LC-HPC-9 Placement.....	84
Figure 2.37: Non-Uniform Application of the Curing Compound on the Deck.....	85
Figure 2.38: Burlap Placement on the Barrier Reinforcement	85
Figure 2.39: Trapped Air Pockets on the Deck (a) Overview; (b) Close-Up	86
Figure 2.40: Wet Curing Application on MN-IC-LC-HPC-9.....	87
Figure 2.41: KS-IC-LC-HPC-1 Lightweight Aggregate Stockpile	97
Figure 2.42: Placement Equipment (a) Manually Operated Gang Vibration System; (b) Double-Drum Roller Screed Followed by Two Metal Pans	101
Figure 2.43: Burlap Drag System	101
Figure 2.44: Poned Water on the Surface of the Bridge Deck.....	102
Figure 2.45: Holes Left on the Surface of the Bridge Deck. (a) Overview; (b) Close-Up View	103
Figure 2.46: Walking Through Consolidated Concrete.....	104
Figure 2.47: Bull Floating and Brooming (a) Bull Floating the Deck; (b) Brooming.....	105
Figure 2.48: Burlap Placement on the Deck	105
Figure 2.49: KS-IC-LC-HPC-2 Lightweight Aggregate Stockpile	107
Figure 2.50: Consolidation and Finishing Equipment	111
Figure 2.51: Walking Observed on Freshly Consolidated Concrete	112
Figure 2.52: Concrete Left Unconsolidated and Unprotected Due to Inoperable Roller Screed	113

Figure 2.53: Over-Finishing the Deck in the Presence of Bleed Water.....	114
Figure 2.54: Burlap Placement of KS-IC-LC-HPC-2 (a) Dry Burlap; (b) Wetting the Burlap on the Deck.....	115
Figure 2.55: Ponding Observed on the Deck.....	116
Figure 2.56: Walking Observed on Freshly Consolidated Concrete	119
Figure 2.57: Malfunctioning of the Machine-Mounted Gang Vibrators	120
Figure 2.58: Applying Finishing Aid to the Concrete Surface	121
Figure 2.59: Malfunctioning of the Fogging System Mounted on the Finishing Machine	121
Figure 2.60: Over-Finishing the Deck in the Presence of Bleed Water (a) Overview; (b) Close-Up View	122
Figure 2.61: KS-IC-LC-HPC-3 Lightweight Aggregate Stockpile	123
Figure 2.62: The Qualification Slab for KS-IC-LC-HPC-3	124
Figure 2.63: The Qualification Slab Placement Equipment	125
Figure 2.64: Excessive Water on the Deck (a) Unadjusted Nozzles; (b) Ponded Water on the Surface.....	128
Figure 2.65: A Leaking Pipe Leaving Water Droplets on the Deck Surface.....	129
Figure 2.66: Applying Finishing Aid to the Concrete Surface	129
Figure 2.67: Bull Floating in the Longitudinal Direction Along with Sheen Water on the Surface.....	130
Figure 2.68: Rewetting the Burlap on the Deck	131
Figure 3.1: Comparison of the Center Pier of MN-IC-LC-HPC-1 (a) From Survey 5; (b) From Survey 6.....	136
Figure 3.2: Crack Map for MN-IC-LC-HPC-1 (Survey 4).....	136
Figure 3.3: Crack Map for MN-IC-LC-HPC-1 (Survey 5).....	137
Figure 3.4: Crack Map for MN-IC-LC-HPC-1 (Survey 6).....	137
Figure 3.5: Crack Map for MN-Control-1 (Survey 4).....	139
Figure 3.6: Crack Map for MN-Control-1 (Survey 5).....	139
Figure 3.7: Crack Map for MN-Control-1 (Survey 6).....	140
Figure 3.8: Crack Map for MN-IC-LC-HPC-2 (Survey 3).....	141
Figure 3.9: Crack Map for MN-Control-2 (Survey 3).....	143
Figure 3.10: Crack Map for MN-IC-LC-HPC-3 (Survey 3).....	144
Figure 3.11: Crack Map for MN-IC-LC-HPC-4 (Survey 2).....	145
Figure 3.12: Crack Map for MN-IC-LC-HPC-4 (Survey 3).....	146
Figure 3.13: Crack Map for MN-IC-LC-HPC-5 (Survey 1).....	147

Figure 3.14: Crack Map for MN-IC-LC-HPC-5 (Survey 2).....	147
Figure 3.15: Crack Map for MN-IC-LC-HPC-5 (Survey 3).....	148
Figure 3.16: Scaling Damage of MN-IC-LC-HPC-5 (a) Near Barriers; (b) A Typical Section for the Remainder of the Deck	149
Figure 3.17: Crack Map for MN-IC-LC-HPC-6 (Survey 1).....	150
Figure 3.18: Crack Map for MN-IC-LC-HPC-6 (Survey 2).....	150
Figure 3.19: Crack Map for MN-IC-LC-HPC-6 (Survey 3).....	151
Figure 3.20: Poor Tining of MN-IC-LC-HPC-6 (a) An Overview; (b) A Close-Up View	152
Figure 3.21: Crack Map for MN-IC-LC-HPC-7 (Survey 1).....	153
Figure 3.22: Crack Map for MN-IC-LC-HPC-7 (Survey 2).....	154
Figure 3.23: Map Cracking on a Typical Section of MN-IC-LC-HPC-8.....	155
Figure 3.24: Crack Map for MN-IC-LC-HPC-8 (Survey 1).....	156
Figure 3.25: Crack Map for MN-IC-LC-HPC-8 (Survey 2).....	156
Figure 3.26: Map Cracking on a Typical Section of MN-IC-LC-HPC-9.....	158
Figure 3.27: Crack Map for MN-IC-LC-HPC-9 (Survey 1).....	158
Figure 3.28: Crack Map for MN-IC-LC-HPC-9 (Survey 2).....	159
Figure 3.29: Underside of MN-IC-LC-HPC-9 Bridge Deck	159
Figure 3.30: Crack Map for KS-IC-LC-HPC-1 (Survey 1)	161
Figure 3.31: Crack Map for KS-IC-LC-HPC-1 (Survey 2)	162
Figure 3.32: Crack Map for KS-IC-LC-HPC-1 (Survey 3).....	162
Figure 3.33: Scaling Damage Observed Near the Shoulders of KS-IC-LC-HPC-1 (Survey 3).....	163
Figure 3.34: Surface Damage Observed on KS-IC-LC-HPC-2-P1	164
Figure 3.35: Crack Map for KS-IC-LC-HPC-2 (Survey 1)	165
Figure 3.36: Crack Map for KS-IC-LC-HPC-2 (Survey 2).....	165
Figure 3.37: Crack Map for KS-IC-LC-HPC-2 (Survey 3).....	166
Figure 3.38: Scaling Damage Observed on Some Portions of KS-IC-LC-HPC-2	167
Figure 3.39: Crack Map for KS-IC-LC-HPC-3 (Survey 1)	168
Figure 3.40: Crack Map for KS-IC-LC-HPC-3 (Survey 2)	168
Figure 3.41: Scaling Damage Observed on Some Portions of KS-IC-LC-HPC-3 During (a) Survey 1 and (b) Survey 2.....	169
Figure 3.42: Crack Density as a Function of Age for IC-LC-HPC and Control Decks	170

Figure 3.43: Crack Densities Versus Deck Age for Monolithic LC-HPC Decks, Minnesota, and Kansas IC-LC-HPC Decks with Good Construction Practices (all had paste contents of 26% or less)	171
Figure 3.44: Crack Densities Versus Deck Age for Utah, Indiana, Minnesota, and Kansas IC Decks	172
Figure E.1: Crack Map for MN-IC-LC-HPC-1 (Survey 1).....	264
Figure E.2: Crack Map for MN-IC-LC-HPC-1 (Survey 2).....	264
Figure E.3: Crack Map for MN-IC-LC-HPC-1 (Survey 3).....	265
Figure E.4: Crack Map for MN-Control-1 (Survey 1).....	265
Figure E.5: Crack Map for MN-Control-1 (Survey 2).....	265
Figure E.6: Crack Map for MN-Control-1 (Survey 3).....	266
Figure E.7: Crack Map for MN-IC-LC-HPC-2 (Survey 1).....	266
Figure E.8: Crack Map for MN-IC-LC-HPC-2 (Survey 2).....	267
Figure E.9: Crack Map for MN-Control-2 (Survey 1).....	267
Figure E.10: Crack Map for MN-Control-2 (Survey 2).....	267
Figure E.11: Crack Map for MN-IC-LC-HPC-1 (Survey 1).....	268
Figure E.12: Crack Map for MN-IC-LC-HPC-3 (Survey 2).....	268
Figure E.13: Crack Map for MN-IC-LC-HPC-4 (Survey 1).....	269

Chapter 1 – Introduction

1.1 General

Bridges are essential components of the U.S. infrastructure, allowing for vehicles to move across the country to areas that would be otherwise inaccessible. There are more than 617,000 bridges in the United States. Forty-two percent of these bridges are over 50 years old and will most likely need to be rehabilitated or replaced (ASCE, 2021). In 2021, the American Society of Civil Engineers (ASCE) reported that 7.5% of U.S. bridges were structurally deficient (ASCE, 2021). Furthermore, for years, travel demands and the costs associated with bridge rehabilitation and replacement have increased while funding has been limited (Koch et al., 2002). As a result, the federal government estimates a backlog of bridge rehabilitation and replacement of \$125 billion (ASCE, 2021).

In 2004, a nationwide survey of state transportation agencies by the Federal Highway Administration's (FHWA) High-Performance Concrete Technology Delivery Team (HPC TDT) indicated that cracking of concrete decks, corrosion of reinforcing steel, cracking of girders and substructures, and freeze-thaw damage of concrete were the topmost bridge deficiencies (Triandafilou, 2005). This study is aimed at the first of these deficiencies by minimizing cracking in bridge decks through the use of internal curing provided by prewetted fine lightweight aggregate combined with proven procedures for constructing low-cracking high-performance concrete (LC-HPC) bridge decks.

1.2 Previous Work

For many years, transportation agencies have been concerned with cracking in bridge decks. As a result, they have attempted to minimize cracking by improving mixture proportions, concrete properties, and construction procedures, as well as implementing crack-reducing technologies (Pendergrass & Darwin, 2014). The initial approach was to use concrete designated as “High-Performance” to help reduce crack-related problems in bridge decks. The term High-Performance Concrete (HPC), in most cases, is translated into mixture proportions with high binder (cementitious materials) contents and low water-to-cementitious material (w/cm) ratios. As such, HPC mixtures have low permeability, protecting reinforcing steel from corrosion. Although

HPC mixtures were meant to improve concrete durability and limit cracking tendency, these early HPC mixtures were associated with high compressive strengths and high paste contents, resulting in increased cracking (Schmitt & Darwin, 1995, 1999; Russell, 2004; Lindquist et al., 2005, 2008; Darwin et al., 2016).

Based on research at the University of Kansas (Schmitt & Darwin, 1995, 1999; Darwin et al., 2004; Lindquist et al., 2005), low-cracking high-performance concrete (LC-HPC) specifications were established to improve the cracking performance of bridge decks. LC-HPC is distinguished from conventional high-performance concrete in that it is specifically designed to minimize cracking. The LC-HPC specifications were implemented in a two-phase pooled-fund study, entitled *Construction of Crack-Free Bridge Decks*, that included the construction of 16 bridge decks between 2005 and 2011 in Kansas and four bridge decks in Minnesota between 2008 and 2010 (Pendergrass et al., 2013). Seventeen of these bridge decks were associated with control decks, constructed following standard Kansas Department of Transportation (KDOT) or Minnesota Department of Transportation (MnDOT) specifications. Annual cracking surveys performed on the Kansas LC-HPC decks demonstrated improved cracking performance in comparison with the control decks (Lindquist et al., 2008; McLeod et al., 2009; Yuan et al., 2011; Pendergrass & Darwin, 2014; Alhmoode et al., 2015; Darwin et al., 2016).

The mixture proportions used in the LC-HPC decks and the subdecks of the paired control bridge decks contained portland cement as the only binder. The LC-HPC specifications included requirements for aggregates, concrete, construction, and were constructed with low cement paste contents, low slump concrete, limitation on maximum compressive strength, enforced concrete temperature control, minimum finishing, adequate and thorough consolidation, and immediate and extended curing. The LC-HPC bridge decks exhibited improved cracking performance, which is attributed to the modifications in the mixture proportions and construction practices. The specifications did not include other crack-reducing technologies, such as internal curing (IC), fiber-reinforced concrete (FRC), and shrinkage-reducing admixtures (SRAs). The LC-HPC specifications developed in Kansas have been modified over the years based on lessons learned in the laboratory and in the field.

In recent years, other crack-reducing technologies, including internal curing (IC), fiber-reinforced concrete, shrinkage-reducing admixtures, with or without incorporating supplementary cementitious materials (SCMs) as partial replacements of portland cement, have been employed by state Departments of Transportation (DOTs) in an effort to reduce further cracking (Guthrie et al., 2014; Barrett et al., 2015; Rupnow et al., 2016; Lafikes et al., 2020; Feng & Darwin, 2020).

As observed in prior research, the effectiveness of crack-reducing technologies in achieving low-cracking and durable concrete is not always guaranteed, especially when poor construction practices are used (McLeod et al., 2009; Khajehdehi & Darwin, 2018; Feng & Darwin, 2020). Therefore, the importance of following good construction procedures is also discussed in this study.

1.3 Internal Curing

Internal water provided through the use of prewetted absorptive materials to enhance cement hydration is referred to as internal curing (IC) (ACI Committee 308 & Committee 213, 2013). By employing internal curing, the absorbed water stored within the water-carrying reservoirs is provided to the cement paste. As hydration begins and water is consumed in the cement paste and as drying begins, the absorbed water is released into the cement paste to promote further hydration and to replace the water lost to evaporation (Bentz & Weiss, 2011).

The benefits of IC on concrete performance have been addressed in a number of studies (Weber & Reinhardt, 1997; Bentz & Snyder, 1999; Cusson & Hoogeveen, 2008; Lindquist et al., 2008; Wei & Hansen, 2008; Reynolds et al., 2009; Browning et al., 2011; Bentz & Weiss, 2011; Castro, 2011; Browning et al., 2011; Pendergrass & Darwin, 2014; Lafikes et al., 2020). These include reduced autogenous and drying shrinkage, reduced plastic settlement cracking, reduced permeability, enhanced cement hydration, and enhanced strength development.

Internal curing can be provided by the use of prewetted lightweight aggregate (LWA), superabsorbent polymers (SAPs), saturated recycled crushed concrete aggregates (CCAs), and saturated wood fibers. Among these water-carrying reservoirs, the use of prewetted LWA has been the most common method to provide internal curing (Bentz & Weiss, 2011). The focus of this

study is to evaluate the effects of IC water content on the shrinkage and durability of concrete mixtures and bridge decks through the use of prewetted LWA.

The use of internal curing, through the use of prewetted lightweight aggregates, was first proposed by Philleo (1991) for high-strength concrete mixtures. Since then, the use of internal curing has been increasing as its benefits have become better recognized. Lightweight aggregate is highly porous, with relatively large pores compared to normal weight aggregates. The absorption of LWA is one of the key properties determining its effectiveness as an internal curing agent, the value of which is highly dependent on the prewetting method and duration (Barrett et al., 2015).

Autogenous shrinkage occurs due to self-desiccation within paste in a sealed system in the absence of water loss to the environment (Radlińska, 2008). Autogenous shrinkage is of particular concern in mixtures with low w/cm ratios (below 0.42), where external wet-curing cannot provide enough water for cement hydration (Mindess et al., 2003) and, in most cases, is not a major concern for bridge decks.

Recent studies have shown the benefits of internal curing for mitigating drying shrinkage. Henkensiefken et al. (2009) examined internally cured mortar mixtures (with different volumes of LWA) with a w/cm ratio of 0.30 on free shrinkage tests (cured under sealed and unsealed conditions). They observed that increasing the quantities of prewetted LWA resulted in decreased drying shrinkage. Browning et al. (2011) investigated the effects of vacuum-saturated LWA containing 5.4, 7.4, and 10.3% of IC water by the weight of binder on drying shrinkage in concrete. They reported that mixtures with IC exhibited less drying shrinkage during the first year after casting than mixtures without IC.

Another benefit of internal curing is in mitigating plastic settlement cracking (Schlitter et al., 2010; Ibrahim et al., 2019). Schlitter et al. (2010) examined the settlement of internally cured mortar mixtures with IC contents ranging from 0 to 7.4% (by the weight of binder). They observed less settlement for mixtures containing IC than for a mixture without IC; the reduction of settlement increases with increasing the quantities of IC. In another study, Ibrahim et al. (2019) investigated the effects of internal curing (IC) water on settlement cracking of mixtures with slumps ranging from 3 to 8½ in. (75 to 215 mm). The term internal curing (IC) water is generally understood to represent water contained in absorbent materials, such as fine lightweight aggregate

that replaces a portion of normal weight aggregate or super-absorbent polymers that are added to concrete. The term is not usually used to also include absorbed water in normal weight aggregates. They concluded that IC using prewetted fine LWA decreased settlement cracking by 37%, compared to mixtures without prewetted fine LWA throughout the range of slumps investigated.

Although the effects have not been investigated extensively, limited studies suggest that internal curing limits ionic transport, which is affected by the volume and connectivity of concrete pores (Castro, 2011). In particular, using the rapid chloride permeability test (RCPT), Thomas (2006) and Lafikes et al. (2020) showed that ion permeability was lower in concrete with internal curing than in concrete without internal curing. Khayat et al. (2018) and Lafikes et al. (2020) also reported that the surface resistivity of mixtures increased when IC was used.

Studies indicate that improved cement hydration and strength development occurs in concretes that incorporate internal curing (Bentz & Weiss, 2011; Castro, 2011). The improved cement hydration is due to an increase in the available water; the improved hydration in turn increases the compressive strength of the concrete. Villarreal and Crocker (2007) reported that the compressive strength of IC mixtures was approximately 1000 psi (6.8 MPa) higher than that of mixtures without IC, suggesting that IC enhances cement hydration.

The amount of LWA required for IC depends on several factors, including the target quantity of IC water and the LWA absorption and desorption values, where absorption is the water holding capacity of LWA as a function of time, and desorption is the loss of water from the pores of the LWA during drying as a function of relative humidity at a constant temperature (Castro, 2011). Bentz and Snyder (1999) proposed an equation, Equation 1.1, to estimate the amount of LWA required for IC mixtures.

The design quantity of W_{LWA} (Weight [lb/yd³] of prewetted lightweight aggregate) can be calculated as:

$$W_{LWA} = \frac{C_f \times IC}{\alpha \times \beta} \quad \text{Equation 1.1}$$

Where:

C_f = Cementitious materials content (lb/yd³)

IC = Target internal curing water (fraction of cementitious materials weight)

α = LWA absorption

β = LWA desorption at specified RH

The concept behind Equation 1.1 was to reduce the effects of autogenous shrinkage. ASTM C1761-17 includes a recommendation that IC water equal to 7% by weight of cementitious material to limit autogenous shrinkage. Although autogenous shrinkage is not common in bridge decks, where the w/cm ratio is usually above 0.42 (Mindess et al., 2003), an IC water content of 7 or 8% by weight of cementitious material is often used (Bentz & Weiss, 2011; Guthrie et al., 2014; Barrett et al., 2015; Lafikes et al., 2018).

1.4 Previous Work on the Effects of Paste Content and Internal Curing on Cracking of Bridge Decks

Based on research at the University of Kansas (KU), with the participation of 19 state departments of transportation, the Federal Highway Administration (FHWA), and industry, low-cracking high-performance concrete (LC-HPC) specifications were established to improve the cracking performance of bridge decks (Schmitt & Darwin, 1995, 1999; Darwin et al., 2004; Lindquist et al., 2005; McLeod et al., 2009; Yuan et al., 2011; Pendergrass & Darwin, 2014; Alhmoode et al., 2015; Darwin et al., 2016). The LC-HPC specifications were implemented in a two-phase Pooled-Fund study, *Construction of Crack-Free Bridge Decks*, which involved the construction of 16 bridge decks between 2005 and 2011 in Kansas. LC-HPC mixtures have low paste contents (below 24.6%) to reduce shrinkage, low slump (1½ to 3 in. [40 to 75 mm]) to limit settlement cracking and limitations on both the maximum and the minimum compressive strengths (5500 and 3500 psi, respectively [37.9 and 24.1 MPa]). In bridge decks, where a high degree of restraint exists, the higher compressive strength decreases creep and increases tensile stresses. The LC-HPC specifications also require an air content between 6.5 to 9.5%. LC-HPC specifications also address construction procedures, including limitations on concrete temperature, and requirements for thorough consolidation, minimal finishing, and early initiation and an extended curing application (Darwin et al., 2016). Annual crack surveys performed on bridge decks constructed in accordance with LC-HPC specifications demonstrated improved cracking performance compared to control decks in the study (Lindquist et al., 2008; McLeod et al., 2009; Yuan et al., 2011; Pendergrass & Darwin, 2014; Alhmoode et al., 2015; Darwin et al., 2016).

Building upon the success of the LC-HPC decks, other crack reducing technologies are available for investigation. One of those technologies involves internal curing (IC) in conjunction

with supplementary cementitious materials. Early application of IC involved mixtures with low w/cm ratios (below 0.42) that were susceptible to autogenous shrinkage (Castro, 2011; Barrett et al., 2015; Jones et al., 2014). More recently, laboratory studies have demonstrated the IC provides reduced shrinkage and improved durability of concrete with w/cm ratios between 0.43 and 0.45, values typically used in the construction of bridge decks, where self-desiccation and autogenous shrinkage are not of concern (Khayat et al., 2018; Lafikes et al., 2020).

Guthrie et al. (2014) conducted field crack surveys of four bridges, two with and two without IC (identified here as UT-IC and UT-Control, respectively), supported by prestressed girders with partial-depth precast concrete deck panels in Utah for two years. All decks had a w/cm ratio of 0.44, a binary system (with partial replacements of portland cement with fly ash), and a paste content of 28%. The two IC decks were proportioned to provide a nominal IC water content of 7% by the weight of binder. As shown in Figure 1.1, the 24-month crack densities reported by Guthrie et al. ranged from 0.43 to 1.148 m/m^2 , representing poor cracking performance even when IC is used. In a parallel study, also illustrated in Figure 1.1, Shrestha et al. (2013) and Khajehdehi and Darwin (2018) investigated a series of bridge decks, also with partial-depth precast concrete deck panels (KS-DP), in Kansas with paste contents of either 24.0 or 24.8%. The results show that the Kansas deck panels exhibited significantly less cracking than the UT decks at a similar age, demonstrating the dominant effect of paste content in cracking (Khajehdehi & Darwin, 2018).

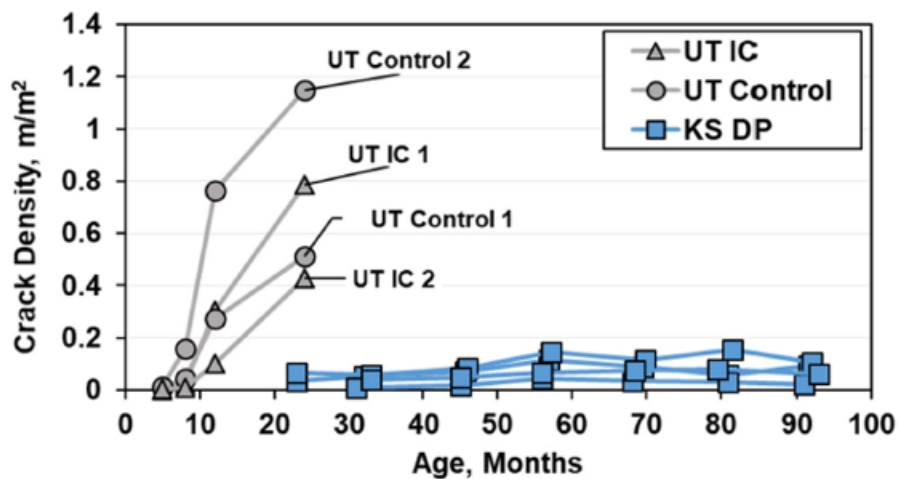

Figure 1.1: Crack Density Versus Age for Deck Panels in Kansas and Utah (Khajehdehi & Darwin, 2018)

Schlitter et al. (2010) and the Indiana Department of Transportation (INDOT) investigated the development of internally cured concrete for use in Indiana and evaluated the shrinkage and durability of the mixtures. They reported a considerable reduction in autogenous and drying shrinkage of IC mortar mixtures compared to mixtures without IC. Additionally, their results illustrated that the relative dynamic modulus of elasticity of mixtures with IC water contents of 2.7 and 5.3% by the weight of binder and a w/cm ratio of 0.30 remained above 100% of the initial value through 300 freezing-thawing cycles. Building on the findings of Schlitter et al. (2010), Di Bella et al. (2012) and Barrett et al. (2015) documented the construction of a series of IC and control (no IC) decks in Indiana. One IC and one control deck containing portland cement as the only binder (identified here as IN-IC and IN-Control, respectively) were constructed in 2010. Both decks had a w/cm ratio of 0.39 and a paste content of 27.6%. The nominal quantity of IC water was 7% by the cement weight (Di Bella et al., 2012). These decks exhibited sub-optimal performance; as a result, four more IC decks were constructed between 2013 and 2015. These additional decks contained a ternary binder system (identified here as IN-IC-HPC, with partial replacements of portland cement with either slag cement and silica fume or fly ash and silica fume) with w/cm ratios between 0.40 and 0.43 and lower paste contents than the first decks, between 24.6 and 26.0%. The latter group of decks were designed for a nominal IC water content of 8% by total weight of binder (Barrett et al., 2015).

Although crack surveys were performed 12 and 20 months after the construction of the IC and control decks placed in 2010, Di Bella et al. did not report measured crack densities. Similarly, crack densities were not reported by Barrett et al. (2015). To quantify the cracking performance in the Indiana decks, Lafikes et al. (2018, 2019, 2020) conducted field surveys of these decks between 2016 and 2018. As shown in Figure 1.2, the results of those surveys, as well as the results of the crack surveys of the Utah IC decks (UT-IC), also shown in Figure 1.2, support the observation that paste content has a dominant effect on cracking. Findings dating back over two decades ago by KU researchers demonstrated that decks with paste contents below 27% (by volume) consistently exhibit less cracking than decks with higher paste contents (such as UT-IC, IN-IC, and IN-Control) (Schmitt & Darwin, 1995; Miller & Darwin, 2000; Darwin et al., 2004; Lindquist et al., 2008; Khajehdehi & Darwin, 2018; Khajehdehi et al., 2021). As shown in Figure 1.2, the decks in Indiana

with a ternary binder system and IC exhibited less cracking than the IC and control decks constructed in 2010 (with portland cement as the only binder and higher total paste contents) within 36 months of construction.

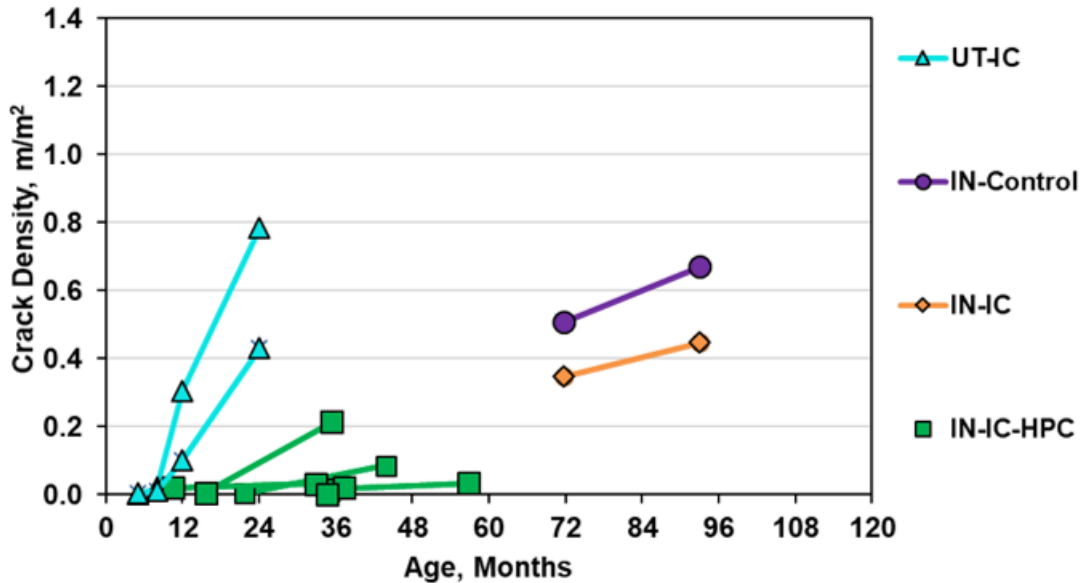

Figure 1.2: Crack Density Versus Age for Indiana Decks (IC and Control) and Utah IC Decks (Lafikes et al., 2020)

Lafikes et al. (2020) conducted field surveys of two bridge decks without IC (as control decks), and four decks with IC and SCMs between 2017 and 2020 in Minnesota; the results of which are included in this report. Three of the decks (two IC decks and one control deck) received a 2-in. (51-mm) thick overlay that contained no IC. Lafikes et al. observed that for decks without overlays, the use of IC and SCMs reduced bridge deck cracking compared to control decks. No improvement, however, was noted for the two IC bridge decks with an overlay, and higher amounts of cracking were reported for these decks than for the decks without an overlay.

Previous studies have shown that, due to higher restraint provided by steel girders, in general, decks supported by steel girders exhibit higher crack densities than those supported by prestressed concrete girders (Shrestha et al., 2013; Darwin et al., 2016; Lafikes et al., 2020).

As discussed above, although bridge decks with IC and SCMs have been constructed recently in a number of states, only in this study has this technology been applied in conjunction with Kansas LC-HPC specifications.

1.5 Objective and Scope

The objective of this study is to investigate the cracking of concrete bridge decks employing internal curing. Concrete mixtures incorporating internal curing, used in conjunction with slag cement with or without small amounts of silica fume (as partial replacements of portland cement), are investigated based on construction observations and crack surveys of bridge decks constructed in Kansas and Minnesota.

In prior work, when constructing bridge decks using concrete mixtures with internal curing, increasing the quantity of internal curing water as a function of binder weight, without an upper limit, has been considered an appropriate way to ensure that the advantages of internal curing are achieved. Recent studies involving freeze-thaw testing of internally cured concrete mixtures, however, have shown that increasing the quantity of internal curing water as a function of binder weight decreases freeze-thaw durability in both the lab and the field (Lafikes et al., 2020).

The effectiveness of internal curing (IC), along with supplementary cementitious materials (SCMs), is evaluated, providing insight into the practical application of IC considering construction practices. As previous studies have indicated, the effectiveness of crack reducing technologies is not always achievable without following proper construction practices (Khajehdehi & Darwin, 2018; Feng & Darwin, 2020; Lafikes et al., 2020). Therefore, there is also a need to address construction issues related to IC, which are considered in relation to observations of previous studies.

Observations for nine IC-LC-HPC and two control bridge decks in Minnesota and three IC-LC-HPC bridge decks in Kansas constructed between 2016 and 2021 in accordance with Minnesota and Kansas internally cured low-cracking high-performance concrete (IC-LC-HPC) specifications are used to develop recommendations that help to minimize or prevent cracking of bridge decks. The importance of following good construction procedures is discussed in light of previous research, which indicates that poor procedures can reduce the effectiveness of crack-reducing technology. The construction procedures, concrete properties, and documented field observations help provide guidance for the construction of future IC-LC-HPC decks.

Chapter 2 – Construction of Internally Cured Low-Cracking High-Performance Concrete (IC-LC-HPC) and Control Bridge Decks in Minnesota and Kansas

2.1 General

This chapter describes the construction of 12 bridge decks in Minnesota and Kansas that incorporate Minnesota and Kansas Department of Transportations (MnDOT and KDOT, respectively) Internally Cured Low-Cracking High-Performance Concrete (IC-LC-HPC) specifications. Of the 12 decks, nine (identified as MN-IC-LC-HPC-1 through 9) were constructed in Minnesota between 2016 and 2020 and are described in Sections 2.2 through 2.4, and three (identified as KS-IC-LC-HPC-1 through 3) were constructed in Kansas between 2019 and 2021 and are described in Sections 2.5 through 2.7. The differences between the MnDOT and KDOT IC-LC-HPC specifications are also discussed. In the cases where the bridge decks were constructed in multiple placements, the placement number (P#) is added to the end of the bridge ID. The construction of two additional decks that followed provisions for High-Performance Concrete (HPC) in Minnesota is also documented and designated as MN-Control-1 and MN-Control-2. MN-Control-1 and -2 decks are paired with MN-IC-LC-HPC-1 and -2, respectively, constructed by the same concrete suppliers and contractors, with similar geometries to assess the effectiveness of IC. For each state, the IC-LC-HPC decks are numbered in the order they were constructed, except for MN-IC-LC-HPC-3, which was constructed before MN-IC-LC-HPC-2 to keep the MN-IC-LC-HPC and MN-Control pairs sequential. An additional deck that was bid under the MnDOT IC-LC-HPC specifications, but not constructed following those specifications, is described as well. This failed IC-LC-HPC deck placement is located near Hinckley and will be discussed in Section 2.4.12. Appendix A provides a spreadsheet that can be used to evaluate the quality of construction.

2.2 MnDOT IC-LC-HPC Specifications

The IC decks constructed in Minnesota followed the requirements of MnDOT specifications 2461 “Structural Concrete” and 2401 “Concrete Bridge Construction,” supplemented by a special provision for Section 2401.2 A, “Concrete,” for designing internally cured concrete mixtures that reduce cracking by incorporating prewetted fine lightweight

aggregate (LWA). The special provision provides materials, mixture designs, concrete properties, and construction requirements. The most recent MnDOT IC-LC-HPC specifications are provided in Appendix B.

2.2.1 Aggregates

The special provisions cover the requirements for fine lightweight aggregate based on a replacement of total aggregate volume with up to 10% prewetted LWA with a maximum size aggregate of $\frac{3}{8}$ in. (9.5 mm). The LWA is required to have achieved acceptable absorption and moisture content at the time of batching. The specifications also cover requirements pertaining to handling and stockpiling LWA, including protection from contamination, segregation, and non-uniform grading and moisture distribution.

In addition to the MnDOT special provisions, several recommendations and procedures dealing with handling, stockpiling, and prewetting LWA were made by KU researchers. The recommendations were based on previous studies involving a series of internally cured bridge decks in Indiana (Barrett et al., 2015). The procedures included prewetting the LWA stockpile using sprinklers for 48 to 72 hours and allowing it to drain for 12 to 15 hours prior to batching. In addition, it was recommended that the LWA stockpile height to be limited to 5 ft (1.5 m) and that it be turned at least twice a day to provide a uniform moisture content. It was also recommended not to use the bottom 4 to 6 in. (100 to 150 mm) of the LWA stockpile because the moisture content is significantly higher than that of the top sections, resulting in non-uniform moisture contents of the LWA when batched.

The LWA absorption and specific gravity should be measured during and after prewetting to ensure that constant values are achieved. A centrifuge (Figure 2.1) is recommended to place the LWA in a prewetted surface-dry (PSD) condition prior to these tests. Miller et al. (2014) and Lafikes et al. (2020) demonstrated that the use of a centrifuge to place LWA in the PSD condition produces more consistent results than the use of paper towels (as indicated in ASTM C1761) for removing surface moisture. The mixture proportions were revised based on the measured LWA absorption and specific gravity values to achieve the design quantity of internal curing (IC) water

(7 or 8% by the weight of binder). It was also recommended by KU researchers that the free-surface moisture content of the LWA be measured within one hour of batching.



Figure 2.1: Centrifuge

To place the aggregates in prewetted surface-dry (PSD) condition, 600 ± 5 g was sampled from the prewetted LWA and distributed uniformly inside the centrifuge bowl (with a radius of 4.5 in. [114 mm]). A 9.75-in. (248-mm) filter ring was secured between the bowl and the lid of the centrifuge. The bowl was then placed in the centrifuge unit, followed by the upper housing mounted over the unit, and secured with clamps. The centrifuge was operated at 2000 rpm for 3 minutes to place the sample in PSD condition. Afterward, the mass of the PSD sample was measured and then transferred to an oven for 24 hours. The 72-hour LWA absorption was then measured to calculate the actual quantity of IC water provided for the mixtures.

The desorption (β in Equation 1.1) was taken to be 1.0 based on the work by Castro (2011) and Khayat (2018), who measured desorption of different types of LWA and reported that as the relative humidity decreased below 90%, the desorption values approached 1.0 rapidly.

The special provisions require that the composite gradation of the aggregates comply with requirements specified in accordance with Table HPC-6, as provided in Appendix B, Section 2.A.7. The specified percentages in Table HPC-6 provide an allowable range for the difference

between the actual gradation of the materials during construction and the original gradations submitted with mixture proportions to MnDOT. Additionally, according to the MnDOT IC-LC-HPC specifications, the volume of lightweight aggregate shall not exceed 10 percent of the total volume of aggregates. With the approval of MnDOT, the adjustments in the quantity of LWA (to obtain the desired quantity of IC water) caused the LWA to exceed 10 percent of the total aggregate volume in some cases, but not by more than 0.9%.

2.2.2 Concrete

Table 2.1 summarizes the concrete requirements in the specifications for the MnDOT IC-LC-HPC decks. The specifications require a water-to-cementitious material (*w/cm*) ratio between 0.43 and 0.45, with a maximum paste content of 27% by concrete volume. The specifications also limit the mass replacement of portland cement by slag cement or silica fume to 28 or 2%, respectively, by the weight of binder. If both are used, total replacement may not exceed 30 percent. No silica fume was used in MnDOT IC-LC-HPC mixtures. The design air content for 2016 decks ranged from 6.5 to 9.5%, while the maximum limit increased slightly to 10% for subsequent years. The design concrete slump range changed substantially, with the maximum limit increasing from 3½ to 5½ in. (90 to 140 mm) between 2016 and 2019 and decreasing to 5 in. (125 mm) in 2020.

According to the specifications, all mixing water must be added at the plant, with no water allowed to be added at the job site. As discussed in Section 2.4, however, in most cases, water was added at the job site to increase pumpability and workability. The addition of set retarding admixtures is allowed in accordance with MnDOT IC-LC-HPC specifications.

Table 2.1: Requirements for Concrete in MnDOT IC-LC-HPC Decks

Construction year	w/cm ratio	Paste content (%)	Maximum SCM (Fly Ash/Slag Cement/Silica Fume/Ternary [%])	Air content (%)	Slump (in.)
2016	0.43-0.45	27	0/28/2/30	6.5-9.5	1-3½
2017				6.5-10	1½-4
2018					1½-5½
2019					1½-5
2020					

Note: 1 in. = 25.4 mm; °C = (°F-32)×5/9; 1 psi = 6.89×10⁻³ MPa

The specifications also provide requirements for hardened concrete properties, such as 28-day compressive strength, rapid chloride permeability, freeze-thaw durability, free shrinkage, and scaling resistance, as shown in Table HPC-5 in Appendix B.

The specifications limit both the maximum and the minimum of 28-day compressive strengths to 5500 and 4000 psi (37.9 and 27.6 MPa), respectively; for the rapid chloride permeability (RCP) test, the maximum charge passed must be less than 2500 and 1500 coulombs at 28 and 56 days, respectively. In addition, the upper limit for shrinkage is 400 microstrain at 28 days. For the freeze-thaw resistance of concrete in accordance with C666-Procedure A, the failure limit is a minimum of 90% of the initial dynamic modulus of elasticity at 300 cycles. The specifications also have a maximum visual rating of 1 by the end of 50 freezing and thawing cycles for specimens tested in accordance with ASTM C672 for scaling resistance.

2.2.3 Construction

To demonstrate that the concrete supplier and the contractor can properly produce, pump, and place IC-LC-HPC, a trial placement containing a minimum of two 10-yd³ (7.6-m³) loads is required at least 14 calendar days before the actual deck placement. Contractors are required to employ the same concrete supplier, ready-mix plant, materials, equipment, and methods used on both the trial and the deck placements. Contractors must also provide deck placement and curing plans such as concrete delivery rates, estimated start and finish time, number of work bridges, and curing methods. According to the specifications, sections of bridge footings, abutments, end diaphragms, and other construction near the project may be used for the trial placements.

During deck construction, MnDOT IC-LC-HPC specifications specify a maximum evaporation rate of 0.2 lb/ft²/hr (1.0 kg/m²/hr). The specifications require contractors to provide a weather forecast confirmation three hours prior to placement to show a low chance of rain during construction, as well as preparation to maintain the evaporation rate below the allowable limit. According to the specifications, the use of finishing aids or evaporation retarders for use in finishing is prohibited.

MnDOT IC-LC-HPC specifications require that full-depth decks be bull floated with a 10 ft (3 m) bull float before carpet dragging, regardless of the specified texturing plan for the final surface. The final surface and curing methods are based on the deck type. Table 2.2 summarizes the deck types and required curing methods in accordance with the specifications.

Table 2.2: Required Curing Method based on Final Deck Surface (Minnesota Department of Transportation, 2018)

Bridge deck type	Final bridge deck surface	Required curing method ^a
Bridge structural slab curing	Low Slump Wearing Course	Conventional wet curing after carpet drag
Bridge deck slab curing for full-depth decks	Bridge Deck Planing	Conventional wet curing after carpet drag.
	Tined Texturing ^b	Conventional wet curing after tine texturing AMS curing compound after wet cure period
	Finished Sidewalk or Trail Portion of Deck (without separate pour above) ^b	Conventional wet curing after applying transverse broom finish AMS curing compound after wet cure period

^a Apply conventional wet curing to bridge slabs following the finishing machine or air screed.

^b Prevent marring of broomed finish or tined textured surface by careful placement of wet curing.

The specifications indicate covering the entire deck with pre-soaked burlap (for at least 12 hours) with no visible openings on the deck within 20 minutes after the final strike-off, followed by white plastic sheeting. The concrete surface is required to remain continuously wet for at least 7 calendar days. Where there are concerns regarding the marring of broomed or tined surface, the specifications allow applying a Poly-Alpha Methylstyrene (AMS) membrane curing compound within 30 minutes of concrete placement followed by conventional wet curing. Conventional wet curing is required to be applied when walking on the surface resulting in no imprints deeper than 1/16 in. (1.6 mm).

2.3 Deck Construction-Minnesota

Table 2.3 summarizes the general information of the decks included in this study. The MnDOT IC-LC-HPC decks were constructed between 2016 and 2020. MN-IC-LC-HPC decks are numbered in the order they were constructed, except for MN-IC-LC-HPC-3, which was constructed before MN-IC-LC-HPC-2, to keep the MN-IC-LC-HPC and MN-Control pairs sequential. In the cases where the bridge decks were constructed in multiple placements, the placement number (P#) is added at the end of the bridge ID. The decks are located in the Twin Cities area, Winona, Pine City, or between Rochester and St. Paul. All decks are supported by prestressed concrete girders. Three of the twelve placements (MN-IC-LC-HPC-1, 5, and MN-Control-1) are pedestrian decks, while the other decks carry vehicular traffic with or without sidewalks.

Table 2.3: MnDOT IC-LC-HPC and MN-Control Deck Information

Bridge ID	Bridge No.	Location	Structure type	Subdeck placement date	Overlay placement dates ^a
MN-IC-LC-HPC-1	62892	Mackubin St. over I-94, St. Paul	Prestressed concrete girders	9/22/2016	-
MN-IC-LC-HPC-2	25036	S.B. T.H. 52 near Cannon Falls,		7/6/2017	9/7/2017, 9/9/2017
MN-IC-LC-HPC-3	25037	T.H. 58 over T.H. 52, Zumbrota		6/29/2017	7/21/2017, 7/24/2017
MN-IC-LC-HPC-4	9619	38 th St. over I-35W, Minneapolis		5/15/2018	-
MN-IC-LC-HPC-5	27700	40 th St. over I-35W, Minneapolis		7/23/2019	-
MN-IC-LC-HPC-6	58826	C.S.A.H. 7 over I-35W near Pine City		9/19/2019	-
MN-IC-LC-HPC-7-P1^b	62735	Dale St. over I-35, St. Paul		6/24/2020	-
MN-IC-LC-HPC-7-P2				9/22/2020	-
MN-IC-LC-HPC-8	85862	C.S.A.H. 12 over I-90, Winona		8/20/2020	-
MN-IC-LC-HPC-9	85863	I-90 over Dakota Valley, Winona		9/4/2020	-
MN-Control-1	62800	Grotto St. over I-94, St. Paul		9/28/2016	-
MN-Control-2	25032	N.B. T.H. 52 near Cannon Falls		9/15/2017	9/28/2017, 9/30/2017

^a Subdeck is topped by a 2-in. overlay, in two days, each day covering half the deck width.

^b P stands for placement.

Half of the IC placements were constructed between May and August, cured in warm ambient temperatures with a longer time for the IC water to be consumed/evaporated prior to exposure to freezing temperatures. The other placements were constructed in September. Three placements received a 2-in. (50-mm) overlay (MN-IC-LC-HPC-2, MN-IC-LC-HPC-3, and MN-Control-2). Overlays were placed in two days, each day covering half the deck width. Except for MN-IC-LC-HPC-7, the remainder of the monolithic decks were placed in one placement. Table 2.4 lists the bridge dimension information, concrete suppliers, and construction contractors for the decks constructed in Minnesota.

Table 2.4: MnDOT IC-LC-HPC and MN-Control Deck Geometry, Project Supplier, and Contractor

Bridge ID	Skew (deg.)	No. of spans	Length (ft)	Width (ft)	Concrete supplier	Contractor
MN-IC-LC-HPC-1	0	2	182.5	14.3	Cemstone Products Co.	Kraemer North America
MN-IC-LC-HPC-2	0	1	153.6	45.3	Ready-Mix Concrete Company L.L.C.	Lunda Construction Co.
MN-IC-LC-HPC-3	0	2	212.0	48.9	Ready-Mix Concrete Company L.L.C.	Lunda Construction Co.
MN-IC-LC-HPC-4	0	4	209.0	56.0	Aggregate Industries U.S.	Lunda Construction Co.
MN-IC-LC-HPC-5	0	2	191.5	16.8	Aggregate Industries U.S.	Lunda Construction Co.
MN-IC-LC-HPC-6	16° 2' 30"	2	188.0	59.8	Cemstone Products Co.	Ames Construction
MN-IC-LC-HPC-7-P1 ^a	2° 24' 38"	2	179.9	56.7	Cemstone Products Co.	Redstone Construction
MN-IC-LC-HPC-7-P2				56.7		
MN-IC-LC-HPC-8	4° 6' 7"	2	229.1	39.0	Modern Ready-Mix Inc.	Icon Constructors
MN-IC-LC-HPC-9	13° 45' 24"	3	143.1	43.0	Modern Ready-Mix Inc.	Icon Constructors
MN-Control-1	0	2	237.0	14.3	Cemstone Products Co.	Kraemer North America
MN-Control-2	0	1	153.6	45.3	Ready-Mix Concrete Company L.L.C.	Lunda Construction Co.

^a P stands for placement.

The IC bridge decks have between one and four spans with skews between 0° and 16° 2' 30". The lengths of the bridges range from 153.6 to 237.0 ft (46.8 to 72.2 m), and the widths range from 14.3 to 56.7 ft (4.4 to 17.2 m).

2.3.1 Concrete Mixture Proportions

The cementitious material percentages and aggregate proportions for each deck are given in Table 2.5. The mixtures for MnDOT IC-LC-HPC decks contained a binary cementitious system, with mass replacement of portland cement (between 27 and 30%) with slag cement. The MnDOT Control decks contained a design binary composition system, with mass replacement of portland cement (25%) with Class F fly ash. The overlay concrete included portland cement as the only binder. Table 2.6 shows the LWA properties obtained by KU personnel as well as the designed values given by the concrete suppliers.

Table 2.5: Cementitious Material Percentages and Aggregate Proportions (SSD/PSD Basis)^a

Bridge ID	Cementitious material percentages ^c (lb/yd ³)	Coarse Agg. (lb/yd ³)		Fine Agg. (lb/yd ³)		LWA Agg. (lb/yd ³)	
		Design	Actual	Design	Actual	Design	Actual
MN-IC-LC-HPC-1	70% C, 30% S	1655	1650	1106	1102	194	191
MN-IC-LC-HPC-2	70% C, 27% S	1411	1415	1141	1144	238	245
MN-IC-LC-HPC-3	70% C, 27% S	1411	1415	1141	1144	238	247
MN-IC-LC-HPC-4	70% C, 28% S	1701	1708	970	973	201	201
MN-IC-LC-HPC-5	70% C, 28% S	1701	1697	948	949	216	215
MN-IC-LC-HPC-6	70% C, 30% S	1641	1631	1092	1084	164	122
MN-IC-LC-HPC-7-P1^d	70% C, 30% S	1643	1637	1098	1095	159	163
MN-IC-LC-HPC-7-P2		1643	1637	1105	1103	156	156
MN-IC-LC-HPC-8	70% C, 30% S	1583	1579	1074	1071	192	193
MN-IC-LC-HPC-9	70% C, 30% S	1583	1579	1113	1108	169	170
MN-Control-1	75% C, 25% F-FA	1719	1716	1318	1315	-	
MN-Control-2	75% C, 25% F-FA	1736	1740	1243	1244	-	
Overlays^b	100% C	1411		1373		-	

^a Actual values are based on the average of trip tickets.

^b Overlay construction records only indicate the design amounts of materials used.

^c Percentages by total weight of cementitious material; C = portland cement; S = Grade 100 slag cement; F-FA = Class F fly ash.

^d P stands for placement.

Note: 1 lb/yd³ = 0.593 kg/m³.

Table 2.6: LWA Properties, Design, and Actual Values Obtained by KU Researchers

Bridge ID	Absorption (% OD basis)		Specific gravity (OD basis)	
	Design	KU measurements	Design	KU measurements
MN-IC-LC-HPC-1	30.0	23.1	1.29	1.35
MN-IC-LC-HPC-2	23.5	24.5	1.35	1.33
MN-IC-LC-HPC-3	23.5	24.9	1.35	1.33
MN-IC-LC-HPC-4	23.6	30.3	1.33	1.26
MN-IC-LC-HPC-5	30.2	27.6	1.27	1.30
MN-IC-LC-HPC-6	27.2	32.9	1.23	1.21
MN-IC-LC-HPC-7-P1^a	32.9	34.0	1.21	1.20
MN-IC-LC-HPC-7-P2		35.1		1.20
MN-IC-LC-HPC-8	30.0	31.1	1.40	1.27
MN-IC-LC-HPC-9	31.1	30.8	1.27	1.28

^a P stands for placement.

Table 2.7 shows the design and actual values of the total weight of cementitious materials, water content, water-to-cementitious material (w/cm) ratio, paste content, and IC water content (if applicable) for each deck. The actual values are based on averages obtained from trip tickets. As will be discussed, the main reason for the differences between the design and actual values, specifically for water content, w/cm ratio, and paste content, is that the concrete suppliers, in most cases, withhold a portion of mixing water from the majority of truckloads. For example, MN-IC-LC-HPC-9 had a design w/cm ratio of 0.43 but an actual w/cm ratio of 0.37, the lowest in this study. The design w/cm ratio for the MnDOT IC-LC-HPC decks was either 0.43 or 0.45, with actual w/cm ratios ranging from 0.40 to 0.43. Subsequently, the actual paste content was reduced in concrete mixtures with lower actual water contents. The design paste contents ranged from 25.4 to 26%, with actual paste contents ranging from 24 to 25.7%. The design IC water content was either 7 or 8%, with actual values ranging from 5.2 to 8.7%. The quantity of IC water was based on the amount of absorbed water and the quantity of LWA in the mixture. The variation in LWA absorption observed in this study resulted in a considerable difference between the design value and the actual quantity of IC water for some decks, as illustrated in Table 2.7. Failure to measure LWA properties correctly can also result in incorrect amounts of mixing water being batched or withheld during batching, affecting actual w/cm ratios and paste contents. Data from individual trip tickets are provided by Bahadori et al. (2023).

Table 2.7: Cementitious Material Content, Water Content, *w/cm* Ratio, Paste, and IC Water Contents for MnDOT IC-LC-HPC and MN-Control Decks^a

Bridge ID	Cementitious material content (lb/yd ³)		Water content (lb/yd ³)		<i>w/cm</i> ratio		Paste content (%)		IC water (% of binder weight)	
	Design	Actual	Design	Actual	Design	Actual	Design	Actual	Design	Actual
MN-IC-LC-HPC-1	550	551	248	239	0.45	0.43	25.4	24.9	8	6.5
MN-IC-LC-HPC-2	564	565	254	244	0.45	0.43	26.0	25.4	8	8.5
MN-IC-LC-HPC-3	564	568	254	240	0.45	0.42	26.0	25.2	8	8.7
MN-IC-LC-HPC-4	582	581	250	245	0.43	0.42	26.0	25.7	8	8
MN-IC-LC-HPC-5	582	581	250	240	0.43	0.41	26.0	25.3	8	8
MN-IC-LC-HPC-6	580	580	248	232	0.43	0.40	26.0	25.0	7	5.2
MN-IC-LC-HPC-7-P1 ^c	580	579	248	239	0.43	0.41	25.9	25.4	7	7.1
MN-IC-LC-HPC-7-P2		579		237		0.41		25.3	7	7
MN-IC-LC-HPC-8	570	571	245	239	0.43	0.42	25.6	25.3	8	8
MN-IC-LC-HPC-9	570	571	245	219	0.43	0.37	25.6	24.0	7	7
MN-Control-1	595	594	250	222	0.42	0.37	26.9	25.3	-	
MN-Control-2	580	582	245	230	0.42	0.40	26.7	25.8	-	
Overlays^b	836		312		0.37		34.3		-	

^a Actual values are based on the average of trip tickets.

^b Overlay construction records only indicate the design amounts of materials used.

^c P stands for placement.

Note: 1 lb/yd³ = 0.593 kg/m³

The mixture proportions of the overlays included portland cement as the only binder, with a paste content and *w/cm* ratio of 34.3% and 0.37, respectively, in accordance with MnDOT 3U17A “Low Slump Concrete” specifications. The trip tickets for the overlays placed on MN-IC-LC-HPC-2, MN-IC-LC-HPC-3, and MN-Control-2 are unavailable.

2.4 Bridge Decks

Table 2.8 summarizes concrete properties, including the average slumps, air contents, concrete temperatures, and 28-day compressive strengths for the MnDOT decks. Construction of each deck is discussed in detail in Sections 2.4.1 through 2.4.11. The average slump ranged from 3¼ to 4¾ in. (80 to 120 mm), with the maximum value corresponding to MN-IC-LC-HPC-4. As discussed in Section 2.2.2, MnDOT allowed an increase in the maximum slump limit over the years from 3½ to 5½ in. (90 to 140 mm), primarily due to the good performance of similar IC decks constructed in Indiana (Lafikes et al., 2020). The average slump for MN-Control-1 and -2 were 4 or 3¼ in. (100 or 80 mm), respectively, well above the specifications range of ½ to 1 in. (15 to 25 mm). Air contents were within the specification limits, ranging from 7.5 to 9.1% for MN-IC-LC-HPC decks and either 6.1 or 6.3% for MN-Control decks. Concrete temperatures were also within the specification limits (50 to 90 °F [10 to 32 °C]), ranging from 64 to 78 °F (18 to 26 °C) for MN-IC-LC-HPC decks and either 66 or 73 °F (19 or 23°C) for MN-Control decks; the 28-day compressive strengths for most of the IC decks, however, exceeded the maximum specifications limit of 5500 psi (37.9 MPa), ranging from 4560 to 7090 psi (31.4 to 48.8 MPa). The 28-day compressive strengths of MN-Control decks were well above 4000 psi (27.6 MPa), the requirement for high-performance concrete mixtures. Based on the work of Khajehdehi and Darwin (2018), higher strength concrete is no longer thought to be an issue in bridge deck cracking.

Table 2.8: Average MnDOT IC-LC-HPC and MN-Control Concrete Properties

Bridge ID	Slump (in.)	Air content (%)	Concrete temperature (°F)	28-day compressive strength (psi)
MN-IC-LC-HPC-1	3¼	7.5	67	7090
MN-IC-LC-HPC-2	3½	9.1	78	4560
MN-IC-LC-HPC-3	3½	8.2	75	5140
MN-IC-LC-HPC-4	4¾	8.9	64	5540
MN-IC-LC-HPC-5	3¾	7.3	77	5320
MN-IC-LC-HPC-6	3½	7.9	71	6490
MN-IC-LC-HPC-7-P1	4½	8.9	73	6630
MN-IC-LC-HPC-7-P2^a	3½	8.2	73	5830
MN-IC-LC-HPC-8^a	4½	7.9	71	6500
MN-IC-LC-HPC-9^a	4½	7.9	72	6320
MN-Control-1	4	6.1	66	6630
MN-Control-2	3¼	6.3	73	5410

^a Values measured before pumping; cylinders were filled from truck discharge.

Note: 1 in. = 25.4 mm; °C = (°F-32)×5/9; 1 psi = 6.89×10⁻³ MPa

2.4.1 MN-IC-LC-HPC-1

MN-IC-LC-HPC-1 is a pedestrian bridge deck located at Mackubin St. over I-94 in St. Paul. The deck was constructed in one placement on September 22, 2016. The concrete supplier and the contractor were Cemstone Products Co. and Kraemer North America, respectively. The bridge has two spans with lengths of 92 ft (28.0 m) and 90 ft-6 in. (27.6 m), for a total length of 182 ft-6 in. (55.6 m). The deck has a 12 ft (3.7 m) wide walkway and a 1 ft-2 in. (0.4 m) wide barrier on each side, for a total deck width of 14 ft-4 in. (4.4 m). The nominal deck thickness is 7 in. (178 mm); the deck is supported by prestressed concrete girders with no skew.

The fine lightweight aggregate (LWA) used in MN-IC-LC-HPC-1 was an expanded clay stored in an open area at the ready-mix plant. A lawn sprinkler was used to prewet the LWA on top of the aggregate stockpile. The stockpile was approximately 4 ft (1.2 m) high, less than the recommended 5-ft (1.5-m) limit. To allow the material to drain properly, the sprinkler was turned off on the morning of deck placement at 7:00 am. Upon KU researchers' request, the LWA stockpile was turned several times before collecting a composite sample to measure the LWA absorption and free surface moisture prior to batching.

The average absorption (OD basis) and specific gravity of the LWA obtained by KU researchers were 23.1% and 1.35, which differed significantly from the value indicated in the original mixture proportions (30% and 1.29, respectively). Having a lower absorption than used for determining batch weights can lead to a lower than the intended quantity of internal curing water. No adjustments, however, were made to the mixture proportions, resulting in an IC water content of 6.5%, lower than the design value of 8% by weight of binder. Representatives from KU were not in attendance during the trial placement for this deck. According to MnDOT personnel, the IC mixture design was approved while emphasizing using the same pump size for the deck construction.

The design and actual (based on the average of trip tickets) mixture proportions are shown in Table 2.9. MN-IC-LC-HPC-1 had a design w/cm ratio of 0.45, a 30% replacement of cement (by total weight of binder) with Grade 100 slag cement, and a design paste content of 25.4%. The design quantity of internal curing water was 8% (by the weight of binder). Based on the trip tickets, either 8 or 17 lb/yd³ (5 or 10 kg/m³) of water was withheld from truckloads, reducing the actual

w/cm ratio to an average of 0.43. Prior to casting, KU researchers measured a total moisture content (absorbed and free) of 28.1% (of the LWA), which was used for batching by the ready-mix plant personnel. Crushed granite and river sand were used as coarse and fine aggregates, respectively. Based on the trip tickets, individual paste contents ranged from 24.6 to 25.0%, with an average of 24.9% and the actual quantities of IC water ranged from 6.4 to 6.6%, with an average of 6.5% by total weight of binder. The dosages of the air-entraining, mid-range water-reducing, and viscosity-modifying admixtures were held constant throughout batching at 0.58, 5, and 3 oz/cwt (0.4, 3.3, and 1.9 mL/kg), respectively.

The concrete properties and compressive strengths are provided in Table 2.10. Only the first truckload was rejected during the construction. The concrete in the first truck was tested for air content and slump after pumping. The air content was 8.4%, within the specified range, but the initial test for the slump showed a 6-in. slump (150-mm), well above 3½ in. (90 mm), the maximum limit of the specifications. A second test was performed and showed a slump of 5½ in. (140 mm), again above the specifications limit, and thus the truckload was rejected. Slumps ranged from 2½ to 4 in. (65 to 100 mm), with an average of 3¼ in. (85 mm); air contents ranged from 7.0 to 8.1%, with an average of 7.5%; concrete temperatures were measured in two tests with the values of 65 and 68 °F (18 and 20 °C), with an average of 67 °F (19 °C), all within the specifications. The 28-day compressive strengths ranged from 6990 to 7200 psi (78.2 to 49.6 MPa), with an average of 7090 psi (48.9 MPa).

Table 2.9: MN-IC-LC-HPC-1 Mixture Proportions (SSD/PSD Basis)

Material	Mixture proportions (lb/yd ³)		
	Design	Actual ^a	
Cement (Type I/II)	385	387	
Grade 100 slag cement	165	164	
Water	248	239	
Fine lightweight aggregate	194	191	
Coarse aggregate	1655	1650	
Fine aggregate	1106	1102	
Chemical Admixture (oz/cwt)			
BASF	Type	Design	Actual ^a
Air AE 90	Air-Entraining	0.1-10	0.58
Polyheed 1020	Mid-range Water-Reducing	1-12	5
Matrix VMA 358	Viscosity-Modifying	0-6	3

^a Actual values based on average of trip tickets.

Note: 1 lb/yd³ = 0.593 kg/m³, 1 oz/cwt = 0.652 mL/kg

Table 2.10: Concrete Test Results-MN-IC-LC-HPC-1

MN-IC-LC-HPC-1	Slump (in.)	Air content (%)	Concrete temperature (°F)	28-day compressive strength (psi)
Minimum	2½	7.0	65	6990
Maximum	3½	8.1	68	7200
Average	3¼	7.5	67	7090

Note: 1 in. = 25.4 mm; °C = (°F-32)×5/9; 1 psi = 6.89×10⁻³ MPa

The bridge was located about 10 minutes away from the ready-mix plant. Placement started on September 22, 2016, at 10:30 pm, at the north end of the deck, continued to the south end, and was completed in the early morning of September 23, 2016, at 2:36 am. The concrete was placed using a pump (located below the bridge), consolidated using a single spud vibrator, and finished using a vibrating screed. The concrete was then bull floated, finished with a broom, and finally covered with wet burlap. The time between batching and discharge ranged from 21 to 34 minutes, with an average of 29 minutes.

During construction, environmental conditions were recorded, with wind speed ranging from 4.6 to 8.1 mph (7.4 to 13 km/hr), relative humidity ranging from 82 to 86%, and ambient air temperature ranging from 60 to 63 °F (16 to 17 °C), resulting in low evaporation rates, ranging

from 0.03 to 0.05 lb/ft²/hr (0.15 to 0.24 kg/m²/hr), well below 0.2 lb/ft²/hr (1 kg/m²/hr), the maximum specifications limit. No significant issues arose during concrete pumping, placement, or finishing. A 20-minute delay occurred, however, at the beginning of the construction (approximately 15 ft [4.3 m] from the north end) due to imperfections left on the surface after the first screed pass. At this location, a 2×4-in. (50×100-mm) manual wooden screed was used to refinish the concrete surface. The time between placement and strike-off ranged from 6 to 52 minutes, with an average of 25 minutes.

The concrete in the last truck was wetter than the concrete in the previous trucks, and a high amount of bleed water was observed on the last 20 ft (6.1 m) of the deck. The contractor chose to delay placing the wet burlap by 60 to 77 minutes under the mistaken assumption that doing so would damage the deck surface (experience in Kansas shows that it would not). The time between strike-off and curing ranged from 13 to 77 minutes. Some scaling damage was observed on the deck (Section 3.3.1.1).

2.4.2 MN-Control-1

The associated control deck for MN-IC-LC-HPC-1, MN-Control-1, is a pedestrian bridge deck located at Grotto St. over I-94 in St. Paul. The deck substructure was constructed in one placement on September 28, 2016. As with MN-IC-LC-HPC-1, the concrete supplier and the contractor were Cemstone Products Co. and Kraemer North America, respectively. The bridge has two equal span lengths of 118 ft-6 in. (36.1 m), for a total length of 237 ft (72.2 m). The deck has a 12 ft (3.7 m) wide walkway, a 1 ft-2 in. (0.4 m) wide barrier on each side, for a total deck width of 14 ft-4 in. (4.4 m). The nominal deck thickness is 7 in. (178 mm); the deck is supported by prestressed concrete girders with no skew.

Representatives from KU were not present during the construction of MN-Control-1. The design and actual (based on the average of trip tickets) mixture proportions are provided in Table 2.11. MN-Control-1 had a design w/cm ratio of 0.42 and a 28% replacement of cement (by total weight of binder) with Class F fly ash, with a design paste content of 26.9%. Based on the trip tickets, between 23 and 33 lb/yd³ (14 or 20 kg/m³) of water was withheld during batching, reducing the actual w/cm ratio to an average of 0.37. Crushed granite and river sand were used as coarse

and fine aggregates, respectively. Based on the trip tickets, individual paste contents ranged from 24.8 to 25.6%, with an average of 25.3%. The dosages of the air-entraining, mid-range water-reducing, and viscosity-modifying admixtures were held constant throughout batching at 0.43, 1, and 3 oz/cwt (0.3, 0.7, and 1.9 mL/kg), respectively.

Table 2.11: MN-Control-1 Mixture Proportions (SSD/PSD Basis)

Material		Mixture proportions (lb/yd ³)	
		Design	Actual ^a
Cement (Type I/II)		446	445
Class F fly ash		149	149
Water		250	222
Coarse aggregate		1719	1716
Fine aggregate		1318	1315
Chemical Admixture (oz/cwt)			
BASF	Type	Design	Actual ^a
Air AE 90	Air-Entraining	0.1-10	0.43
Polyheed 1020	Mid-range Water-Reducing	1-12	1
Matrix VMA 358	Viscosity-Modifying	0-6	3

^a Actual values based on average of trip tickets.

Note: 1 lb/yd³ = 0.593 kg/m³, 1 oz/cwt = 0.652 mL/kg

The concrete properties and compressive strengths are provided in Table 2.12. Slumps ranged from 3¾ to 4 in. (95 to 100 mm), with an average of 4 in. (100 mm); air contents ranged from 5.6 to 6.8%, with an average of 6.1%; concrete temperatures were measured in two tests with the values of either 62 and 70 °F (16 or 21 °C), with an average of 66 °F (19 °C), all within the MnDOT specifications. The 28-day compressive strengths ranged from 6360 to 6820 psi (43.9 to 47.0 MPa), with an average of 6630 psi (45.7 MPa).

Table 2.12: Concrete Test Results-MN-Control-1

MN-Control-1	Slump (in.)	Air content (%)	Concrete temperature (°F)	28-day compressive strength (psi)
Minimum	3¾	5.6	62	6360
Maximum	4	6.8	70	6820
Average	4	6.1	66	6630

Note: 1 in. = 25.4 mm; °C = (°F-32)×5/9; 1 psi = 6.89×10⁻³ MPa

2.4.3 MN-IC-LC-HPC-2 – Deck with Overlay

MN-IC-LC-HPC-2 is a two-lane bridge that carries southbound traffic on T.H. 52 over the Little Cannon River, near Cannon Falls. The concrete supplier and the contractor were Ready-Mix Concrete Company L.L.C. and Lunda Construction Co., respectively. The bridge has one span with a length of 153 ft-7 in. (46.8 m). The deck has a 42 ft (12.8 m) wide roadway with a 1 ft-8 in. (0.5 m) wide barrier on each side, for a total deck width of 45 ft-4 in. (13.8 m). The deck thickness includes a 7-in. (178-mm) subdeck and a 2-in. (51-mm) thick overlay, for a total thickness of 9 in. (229 mm). The overlay placed on the deck later did not incorporate IC; the deck is supported by prestressed concrete girders with no skew.

The fine lightweight aggregate (LWA) used in MN-IC-LC-HPC-2 was an expanded clay stored in an open area at the ready-mix plant. A lawn sprinkler was used to prewet the LWA located on top of a partition wall near the aggregate stockpile. The stockpile was approximately 7 ft (2.1 m) high, greater than the recommended 5-ft (1.5-m) limit, as shown in Figure 2.2. The sprinklers were turned off the night before deck placement, letting the material drain for about 14 hours. Upon KU researchers' request, the LWA stockpile was turned several times before collecting a composite sample to measure the LWA absorption and free surface moisture prior to batching.



Figure 2.2: Lightweight Aggregate Stockpile for MN-IC-LC-HPC-2

One of the MN-IC-LC-HPC-2 abutments was used as a trial placement. Although KU researchers were not in attendance during the trial placement, they were informed that concrete properties met the specifications with no problems observed during pumping.

The average absorption (OD basis) and the specific gravity (OD basis) of the LWA obtained by KU researchers were 24.5% and 1.33, respectively, which differed slightly from the values indicated in the original mixture proportions (23.5% and 1.35, respectively). No adjustments, however, were made to the mixture proportions based on the differences in the LWA properties between those obtained by KU and those indicated in the original design. Prior to casting, KU researchers measured a total moisture content of 31% (of the LWA), which was used by the ready-mix plant personnel.

The design and actual (based on the average of trip tickets) mixture proportions of the subdeck are provided in Table 2.13. MN-IC-LC-HPC-2 had a design w/cm ratio of 0.45 and a 27.3% replacement of cement (by total weight of binder) with Grade 100 slag cement, with a design paste content of 26%. The design quantity of internal curing water was 8% (by the weight of binder). Based on the trip tickets, 17 lb/yd³ (20 kg/m³) of water was withheld during batching, resulting in stiff concrete with a w/cm ratio as low as 0.42. A portion of the withheld water ranging from 5 to 10 lb/yd³ (3 to 6 kg/m³) was added back at the jobsite, increasing the w/cm ratio to an average of 0.43. Crushed granite and river sand were used as coarse and fine aggregates, respectively. Based on the trip tickets, paste contents ranged from 24.6 to 25.7%, with an average of 25.4% and the actual quantity of IC water ranged from 8.4 to 8.6%, with an average of 8.5% by total weight of binder. The dosages of the air-entraining, mid-range water-reducing, and viscosity-modifying admixtures were held constant throughout batching at 0.9, 3, and 2 oz/cwt (0.6, 1.9, and 1.3 mL/kg), respectively. A set-retarding admixture was added to all truckloads at a dosage of 2 oz/cwt (1.3 mL/kg).

The concrete properties and compressive strengths are listed in Table 2.14. Slump tests showed the same value of 3½ in. (90 mm); air contents ranged from 9.0 to 9.3%, with an average of 9.1%; concrete temperatures ranged from 76 to 81 °F (24 or 27 °C), with an average of 78 °F (26 °C), all within the specifications. The 28-day compressive strengths ranged from 4370 to 4670 psi (30.1 to 32.2 MPa), with an average of 4560 psi (31.4 MPa).

Table 2.13: MN-IC-LC-HPC-2 Subdeck Mixture Proportions (SSD/PSD Basis)

Material	Mixture proportions (lb/yd ³)		
	Design	Actual ^a	
Cement (Type I/II)	410	411	
Grade 100 slag cement	154	154	
Water	254	244	
Fine lightweight aggregate	238	245	
Coarse aggregate	1411	1415	
Fine aggregate	1141	1144	
Chemical Admixture (oz/cwt)			
GRT	Type	Design	Actual ^a
Polyheed SA50	Air-Entraining	As needed	0.9
KB 1200	Mid-range Water-Reducing	3-12	3
Polychem VMA	Viscosity-Modifying	2-5	2
Polychem Renu	Set-Retarding	3-6	2

^a Actual values based on average of trip tickets.

Note: 1 lb/yd³ = 0.593 kg/m³, 1 oz/cwt = 0.652 mL/kg

Table 2.14: Concrete Test Results-MN-IC-LC-HPC-2 Subdeck

MN-IC-LC-HPC-2 subdeck	Slump (in.)	Air content (%)	Concrete temperature (°F)	28-day compressive strength (psi)
Minimum	3½	9.0	76	4370
Maximum	3½	9.3	81	4670
Average	3½	9.1	78	4560

Note: 1 in. = 25.4 mm; °C = (°F-32)×5/9; 1 psi = 6.89×10⁻³ MPa

MN-IC-LC-HPC-2 was located about 25 minutes away from the ready-mix plant. Construction of the subdeck started on July 6, 2017, at 7:00 am, at the south end of the deck, continued to the north end, and was completed at 9:45 am. The concrete was placed using two pumps positioned at opposite ends of the deck, consolidated using a single spud vibrator, and finished using two vibrating screeds (one 17 ft [5.2 m] long and the other 24 ft [7.3 m] long) each with a carpet drag, as shown in Figure 2.3. There was a gap about 2 ft (0.6 m) wide between the two screeds, as well as two gaps about 1 ft (0.3 m) wide between the end of the screeds and the barrier reinforcement. The concrete in these gaps was consolidated by the spud vibrator and finished by bull floating. Bull floating was performed mostly in the transverse direction, with some in the longitudinal direction (near the centerline).



Figure 2.3: Finishing Equipment for MN-IC-LC-HPC-2 Subdeck

During construction, the wind speed ranged from 0 to 1.7 mph (0 to 2.7 km/hr) and ambient air temperature ranged from 74 to 84 °F (23 to 29 °C), resulting in low evaporation rates, ranging from 0.01 to 0.03 lb/ft²/hr (0.05 to 0.15 kg/m²/hr), well below 0.2 lb/ft²/hr (1 kg/m²/hr), the maximum specification limit. No significant issues arose during concrete pumping, placement, or finishing. The time between batching and discharge ranged from 37 to 48 minutes, with an average of 42 minutes. The deck was finished efficiently with an average time of 2 minutes after placement.

One work bridge was used to place wet burlap on the deck. A layer of burlap was placed on with an average time of 15 minutes after strike-off. On some occasions, it was observed that water dripped onto the deck from rolls of burlap stacked on the work bridge, leaving ponds of water on the east side of the deck near the barrier, as shown in Figure 2.4.



Figure 2.4: Water from Burlap Dripping onto the Deck

MN-IC-LC-HPC-2 received a 2-in. (25-mm) wearing course (overlay) on July 21 and July 24, 2017, for the right lane and shoulder, and left lane and shoulder, respectively. The procedures for placing the overlay were similar for both placements. KU researchers were in attendance only during the left lane and shoulder overlay placement on July 24. A paving mix was designated for the overlay with no internal curing.

The mixture had a w/cm ratio of 0.32 with a paste content of 31.8%. The concrete for overlay was provided using a mobile mixer at the job site. Immediately before overlay placement, the subdeck was cleaned and sandblasted, followed by brooms to remove debris from the surface. A layer of bonding grout (sand, water, and portland cement) was then applied to the surface. The concrete was transported using buggies and deposited on the subdeck. A pavement finishing machine was used to finish the concrete surface, followed by bull floats and trowels. The surface was then tined with an artificial grass-type carpet drag followed by transverse tining. The curing compound was applied to the surface within 22 minutes of finishing (within 12 minutes of tining) followed about 2 hours later by wet burlap, followed by plastic sheeting. The single cylinder made from the right lane and shoulder overlay concrete had a 28-day compressive strength of 7060 psi

(48.7 MPa); the two cylinders made at different locations from the left lane and shoulder overlay concrete had 28-day compressive strengths of 7130 and 8450 psi (49.2 and 58.3 MPa).

2.4.4 MN-Control-2 – Deck with Overlay

The associated control deck for MN-IC-LC-HPC-2, MN-Control-2, is a two-lane bridge that carries northbound traffic on T.H. 52 over the Little Cannon River, near Cannon Falls. As with MN-IC-LC-HPC-2, the concrete supplier and the contractor were Ready-Mix Concrete Company L.L.C. and Lunda Construction Co., respectively. The bridge has the same geometry, deck, and girder type as MN-IC-LC-HPC-2 with a 7-in. (178-mm) subdeck and a 2-in. (51-mm) thick overlay, for a total thickness of 9 in. (229 mm).

Representatives from KU were not present during the construction of the MN-Control-2 subdeck and overlay. Based on the trip tickets, placement of the subdeck started on September 15, 2017, at 11:15 am and finished at 2:26 pm. The design and actual (based on the average of trip tickets) mixture proportions of the subdeck are provided in Table 2.15. MN-Control-2 subdeck had a design w/cm ratio of 0.42 and a 35% replacement of cement (by total weight of binder) with Class F fly ash, with a design paste content of 26.7%. Crushed granite and river sand were used as the coarse and fine aggregates, respectively. The mixture proportions also included macrofibers at a dosage of 4 lb/yd³ (2.4 kg/m³). The MN-Control-2 wearing course (overlay) did not incorporate fibers.

Based on the trip tickets, approximately 25 lb/yd³ (15 kg/m³) of water was withheld during batching, resulting in a w/cm ratio as low as 0.38. Therefore, a portion of the withheld water, ranging from 3 to 15 lb/yd³ (2 to 9 kg/m³), was added back to some truckloads, increasing the w/cm ratio to an average of 0.40. Based on the trip tickets, the paste content ranged from 25.4 to 26.3%, with an average of 25.8%. The dosages of the mid-range water-reducing admixture and superplasticizer were held constant throughout batching at 3 and 2 oz/cwt (1.9 and 1.2 mL/kg), respectively. A set-retarding admixture was added to all truckloads at a dosage of 3 oz/cwt (1.9 mL/kg).

Table 2.15: MN-Control-2 Subdeck Mixture Proportions (SSD/PSD Basis)

Material		Mixture proportions (lb/yd ³)	
		Design	Actual ^a
Cement (Type I/II)		377	379
Class F fly ash		203	203
Water		245	230
Macrofibers ^b		4	4
Coarse aggregate		1736	1740
Fine aggregate		1243	1244
Chemical Admixture (oz/cwt)			
GRT	Type	Design	Actual ^a
Polyheed SA50	Air-Entraining	As needed	0.4-0.5
KB 1200	Mid-range Water-Reducing	3-12	3
Polychem SPC	Superplasticizer	2-20	2
Polychem Renu	Set-Retarding	3-6	3

^a Actual values based on average of trip tickets.

^b GRT Advantage Macrosynthetic Fibers

Note: 1 lb/yd³ = 0.593 kg/m³, 1 oz/cwt = 0.652 mL/kg

The concrete properties and compressive strengths are provided in Table 2.16. Slumps ranged from 3 to 3½ in. (75 to 95 mm), with an average of 3¼ in. (85 mm); air contents ranged from 5.5 to 7.2%, with an average of 6.3%; concrete temperatures ranged from 71 to 73 °F (21.5 to 23 °C), with an average of 72 °F (22 °C), all of which were within the specifications. The 28-day compressive strengths ranged from 4520 to 5580 psi (31.2 to 38.5 MPa), with an average of 5140 psi (35.4 MPa).

Table 2.16: Concrete Test results-MN-Control-2 Subdeck

MN-Control-2 subdeck	Slump (in.)	Air content (%)	Concrete temperature (°F)	28-day compressive strength (psi)
Minimum	3	5.5	72	4520
Maximum	3½	7.2	75	5580
Average	3¼	6.3	73	5410

Note: 1 in. = 25.4 mm; °C = (°F-32)×5/9; 1 psi = 6.89×10⁻³ MPa

MN-Control-2 received a 2-in. (25-mm) wearing course (overlay) on September 28 and September 30, 2017, for the right lane and shoulder and the left lane and shoulder, respectively. The procedures for placing the overlay were similar to that described in Section 2.4.3. The mixture had a *w/cm* ratio of 0.32 with a paste content of 31.8%. Two cylinders were made from the right

lane and shoulder overlay with 28-day compressive strengths of 8870 and 9480 psi (61.2 and 65.4 MPa); two cylinders were made from the left lane and shoulder overlay with 28-day compressive strengths of 7760 and 8650 psi (53.5 and 59.6 MPa).

2.4.5 MN-IC-LC-HPC-3 – Deck with Overlay

MN-IC-LC-HPC-3 is a two-way bridge that carries traffic on T.H. 58 over T.H. 52 in Zumbrota. The subdeck was constructed in one placement on June 29, 2017. Even though MN-IC-LC-HPC-3 was placed a week before MN-IC-LC-HPC-2, the numbering was assigned so that the MN-IC-LC-HPC and corresponding MN-Control decks could be paired sequentially. As with MN-IC-LC-HPC-2, the concrete supplier and the contractor were Ready-Mix Concrete Company L.L.C. and Lunda Construction Co., respectively, and the concrete supplier used the same materials as used for MN-IC-LC-HPC-2. The bridge has two equal span lengths of 106 ft (32.3 m), for a total length of 212 ft (64.6 m). The deck has a 34 ft (10.4 m) wide roadway with a 12 ft (3.7 m) sidewalk and a 1 ft-3 in. (0.4 m) wide barrier on the west side, and a 1 ft-8 in. (0.5 m) wide barrier on the east side, for a total deck width of 48 ft-11 in. (14.9 m). The deck thickness includes a 7-in. (178-mm) subdeck and a 2-in. (51-mm) thick overlay, for a total thickness of 9 in. (229 mm). The sidewalk and the overlay placed on the deck did not incorporate IC; the deck is supported by prestressed concrete girders with no skew.

One of the MN-IC-LC-HPC-2 abutments was used as a trial placement. KU researchers were not in attendance during the trial placement but were informed that concrete properties met the specification limits with no problems observed during pumping.

The average absorption (OD basis) and the specific gravity (OD basis) of the LWA obtained by KU researchers were 24.9% and 1.33, respectively, which differed slightly from the values in the original mixture proportions (23.5% and 1.35, respectively). No adjustments were made to the mixture proportions based on the differences in the LWA properties between those obtained by KU and those in the original design. Prior to casting, KU researchers measured a total moisture content of 32% (of the LWA), which was used by the ready-mix plant personnel.

The design and actual (based on the average of trip tickets) mixture proportions of the subdeck are provided in Table 2.17. MN-IC-LC-HPC-3, which had the same mixture proportions

as used for MN-IC-LC-HPC-2, had a design w/cm ratio of 0.45 and a 27.3% replacement of cement (by total weight of binder) with Grade 100 slag cement, with a design paste content of 26%. The design quantity of internal curing water was 8% (by the weight of binder). Based on the trip tickets, either 25 or 33 lb/yd³ (15 or 20 kg/m³) of water was withheld during batching, resulting in a w/cm ratio as low as 0.40. A portion of the withheld water, ranging from 4 to 17 lb/yd³ (2.3 to 10 kg/m³), was added back at the jobsite, increasing the w/cm ratio to an average of 0.42. Based on the trip tickets, individual paste contents ranged from 24.5 to 25.6%, with an average of 25.2% and the actual quantities of IC water ranged from 8.2 to 9%, with an average of 8.7% by total weight of binder. The air-entraining admixture dosage varied between 0.8 and 0.9 oz/cwt (0.5 and 0.6 mL/kg) throughout batching. The dosages of the mid-range water-reducing and viscosity-modifying admixtures were held constant throughout batching at 3 and 2 oz/cwt (2 and 1.3 mL/kg), respectively. A set-retarding admixture was added to truckloads at a varied dosage between 0 and 3 oz/cwt (0 and 2 mL/kg).

Table 2.17: MN-IC-LC-HPC-3 Subdeck Mixture Proportions (SSD/PSD Basis)

Material		Mixture proportions (lb/yd ³)	
		Design	Actual ^a
Cement (Type I/II)		410	414
Grade 100 slag cement		154	154
Water		254	240
Fine lightweight aggregate		238	247
Coarse aggregate		1411	1415
Fine aggregate		1141	1144
Chemical Admixture (oz/cwt)			
GRT	Type	Design	Actual ^a
Polyheed SA50	Air-Entraining	As needed	0.8-0.9
KB 1200	Mid-range Water Reducing	3-12	3
Polychem VMA	Viscosity-Modifying	2-5	2
Polychem Renu	Set Retarding	3-6	0-3 ^b

^a Actual values based on average of trip tickets.

^b Set retarder dosage stepped down from 3 to 0 oz/cwt throughout the placement.

Note: 1 lb/yd³ = 0.593 kg/m³, 1 oz/cwt = 0.652 mL/kg

The concrete properties and compressive strengths are listed in Table 2.18. Slump ranged from 2½ to 4 in. (65 to 100 mm), with an average of 3½ in. (90 mm); air contents ranged from 8 to 9.1%, with an average of 8.2%; concrete temperatures ranged from 73 to 77 °F (23 or 25 °C), with an average of 75 °F (24 °C), all of which were within the specifications. The 28-day compressive strengths ranged from 4160 to 6250 psi (28.7 to 43.1 MPa), with an average of 5140 psi (35.4 MPa).

Table 2.18: Concrete Test results-MN-IC-LC-HPC-3 Subdeck

MN-IC-LC-HPC-3 subdeck	Slump (in.)	Air content (%)	Concrete temperature (°F)	28-day compressive strength (psi)
Minimum	2½	8	73	4160
Maximum	4	9.1	77	6250
Average	3½	8.2	75	5140

Note: 1 in. = 25.4 mm; °C = (°F-32)×5/9; 1 psi = 6.89×10⁻³ MPa

MN-IC-LC-HPC-3 was located approximately 25 minutes away from the ready-mix plant. Construction of the subdeck started on June 29, 2017, at 9:00 am, at the north end of the deck, continued to the south end, and was completed at 12:30 pm. The concrete was placed using two pumps positioned at opposite ends of the deck, consolidated using a single spud vibrator, and finished using two vibrating screeds (one 17 ft [5.2 m] long and the other 24 ft [7.3 m] long), each with a carpet drag. There was a gap of about 2 ft (0.6 m) between the two screeds, as well as gaps of about 1 ft (0.3 m) between the end of the screeds and the barrier reinforcement. Concrete in these gaps was consolidated by the spud vibrator and finished with a bull float. At multiple locations, it was observed that contractor personnel walked in the consolidated concrete through the 2 ft (0.6 m) wide gap between the screeds, disturbing the concrete. These locations were later finished using trowels, as shown in Figure 2.5, resulting in insufficient consolidation.

During the construction, environmental conditions were recorded, with wind speed ranging from 1 to 5 mph (1.6 to 8 km/hr), relative humidity ranging from 59 to 71%, and ambient air temperature ranging from 69 to 79 °F (23 to 29 °C), resulting in low evaporation rates, ranging from 0.03 to 0.06 lb/ft²/hr (0.15 to 0.29 kg/m²/hr), well below 0.2 lb/ft²/hr (1 kg/m²/hr), the maximum specification limit. No significant issues arose during concrete pumping, placement, or

finishing. The time between batching and discharge ranged from 15 to 65 minutes, with an average of 25 minutes. The deck was finished efficiently with an average time of 5 minutes after placement.

One work bridge was used to place wet burlap on the deck. A layer of burlap was placed in an average time of 16 minutes after strike-off. Similar to MN-IC-LC-HPC-2, on some occasions, it was observed that water dripped onto the deck from rolls of burlap stacked on the work bridge, leaving puddles of water on the east side of the deck, as shown in Figure 2.6.



Figure 2.5: Walking through Freshly Consolidated Concrete

One work bridge was used to place wet burlap on the deck. A layer of burlap was placed in an average time of 16 minutes after strike-off. Similar to MN-IC-LC-HPC-2, on some occasions, it was observed that water dripped onto the deck from rolls of burlap stacked on the work bridge, leaving puddles of water on the east side of the deck, as shown in Figure 2.6.

MN-IC-LC-HPC-3 received a 2-in. (25-mm) wearing course (overlay) on September 7 and September 9, 2017. KU researchers were not in attendance during overlay placements. The procedures for placing the overlay were similar to that described in Section 2.4.3. The overlay mixture had a w/cm ratio of 0.32 with a paste content of 31.8%. The two cylinders made from the September 7, 2017, placement had 28-day compressive strengths of 9030 and 9270 psi (62.3 and

63.9 MPa); the three cylinders made from September 9, 2017, placement had 28-day compressive strengths of 8860, 9000, and 9050 psi (61.1, 62.1, and 62.4 MPa).



Figure 2.6: Water from Burlap Dripping onto the Deck (a) An Overview; (b) A Close-Up View

2.4.6 MN-IC-LC-HPC-4

MN-IC-LC-HPC-4 is a two-way bridge that carries traffic on 38th St. over I-35W in Minneapolis. The deck was constructed in one placement on May 15, 2018. The concrete supplier and the contractor were Aggregate Industries U.S. and Lunda Construction Co., respectively. The bridge has four spans with lengths of 28 ft-10 in. (8.8 m), 77 ft-8 in. (23.8 m), 77 ft-8 in. (23.7 m), and 24 ft-10 in. (7.6 m), for a total length of 209 ft (63.7 m). The deck has a 36 ft (10.9 m) wide roadway, a 1 ft-7 in. (0.4) wide barrier and a 10 ft (3.0 m) sidewalk on each side, for a total deck width of 56 ft (17.1 m). The 6-in. (150-mm) thick sidewalk placed on the deck at a later date did

not incorporate IC. The nominal deck thickness is 9 in. (229 mm). The bridge deck is supported by prestressed concrete girders with no skew.

The fine lightweight aggregate (LWA) used in MN-IC-LC-HPC-4 was an expanded clay stored in a garage at the ready-mix plant. The LWA was prewetted using a lawn sprinkler on top of the aggregate stockpile. The stockpile was approximately 10 ft (3 m) high, greater than the recommended 5-ft (1.5-m) limit.

MN-IC-LC-HPC-4 had two trial placements. The first trial placement, attempted on May 3, 2018, was a failure. The initial mixture had a binary binder composition, a 28% replacement by weight of portland cement with slag cement. The design paste content and the w/cm ratio were 25.5% (by concrete volume) and 0.43, respectively. The design quantity of internal curing water was 8% (by the weight of binder), the lightweight aggregate design absorption was 23.6% (OD basis), and the slump was 4 in. (100 mm). KU researchers were not in attendance for the first trial placement. The concrete produced at the ready-mix plant could not be pumped, also most likely presenting issues for placement and finishing of the deck. The contractor and pump operator believed a higher slump range was required to ensure the pumpability of the concrete. The specifications permitted slumps between 1½ and 4 in. (40 to 100 mm). The problem was, in fact, the incorrect measurement of free-surface moisture of the LWA. Lightweight aggregate is highly porous, with relatively large pores compared to normal weight aggregates. The absorption of LWA is highly dependent on the prewetting method and duration. Although the LWA stockpile was prewetted for more than two weeks, no absorption or specific gravity tests were performed at the ready-mix plant. Without measuring the actual absorption of the LWA, the concrete supplier simply subtracted the design absorption value from the total moisture content of a LWA sample, determined the free-surface moisture of the LWA, and batched the concrete, which is not correct.

A second trial placement was performed successfully on May 8, 2018, with KU researchers in attendance. Upon KU researchers' request, the LWA stockpile was turned several times before collecting a composite sample to measure the LWA absorption before batching. The average absorption (OD basis) of the LWA obtained by KU researchers was 30.3%, which differed significantly from the value indicated in the original mixture proportions (23.6%). With the way that moisture corrections are made, a higher absorption results in a lower calculated value for the

free-surface moisture, increasing the risk of holding excess water, and thus increasing pumping issues. With a true 30.3% absorption instead of 23.6%, the incorrect modifications in the batch weights would have decreased the mixture water, the w/cm , and the paste content by 16 lb/yd³ (9.5 kg/m³), 0.03, and 0.95%, respectively.

The major changes in the batch weights for the second trial placement included using the correct LWA properties, increasing the paste content from 25.5 to 26%, and increasing the VMA dosage from 3 to 5 oz/cwt (1.9 to 3.3 mL/kg), which allowed the concrete to pump efficiently. Additionally, MnDOT allowed a maximum slump of 5½ in. (140 mm) to relieve the contractor's concerns and further aid pumping. Studies published after the original specifications were developed have demonstrated that for paste contents similar to MN-IC-LC-HPC decks, a slump as high as 5¾ in. (145 mm) does not adversely affect bridge deck cracking (Lafikes et al., 2019, 2020). The concrete was tested after a simulated haul time of 15 minutes. The concrete slumps (with an average of 4¼ in. [105 mm]) and air contents (with an average of 8.9%) after pumping were within the specifications. Approvals were made for the revised mixture proportions following the successful trial placements.

Another shipment of LWA was delivered to the ready-mix plant the next day to ensure a sufficient supply of LWA for the construction. KU researchers found similar absorption values in the new composite samples and confirmed the revised mixture proportions. The sprinkler was turned off on the morning of deck placement, letting the material drain for approximately 14 hours prior to batching.

The initial, revised, and actual (based on the average of trip tickets) mixture proportions are listed in Table 2.19. The initial mixture proportions correspond to the first trial batch mix, and the revised mixture proportions correspond to the second trial and deck placements. MN-IC-LC-HPC-4 had a design w/cm ratio of 0.43 and a 28% replacement of cement (by total weight of binder) with Grade 100 slag cement, with a design paste content of 26%. The design quantity of internal curing water was 8% (by the weight of binder). Prior to casting, KU researchers measured a total moisture content of 37.4% (of the LWA), which was used by the ready-mix plant personnel. Based on the trip tickets, approximately 5 lb/yd³ (5 kg/m³) of water was held from most of the truckloads during the construction, reducing the actual w/cm ratio to an average of 0.42. Crushed

gravel and river sand were used as coarse and fine aggregates, respectively. Based on the trip tickets, paste contents ranged from 25.5 to 26%, with an average of 25.7% and the actual quantity of IC water ranged from 7.9 to 8.6%, with an average of 8% by total weight of binder. The air-entraining admixture dosage varied between 0.28 and 0.33 oz/cwt (0.18 and 0.22 mL/kg) throughout batching. The dosage of the high-range water-reducing admixture varied between 1.75 and 2.75 oz/cwt (1.1 and 1.8 mL/kg) throughout batching; the dosage of viscosity-modifying admixture was held constant throughout batching at 5 oz/cwt (3.3 mL/kg).

Table 2.19: MN-IC-LC-HPC-4 Mixture Proportions (SSD/PSD Basis)

Material	Mixture proportions (lb/yd ³)		
	Initial	Revised	Actual ^a
Cement (Type I/II)	410	418	416
Grade 100 slag cement	160	164	165
Water	245	250	245
Fine lightweight aggregate	239	201	201
Coarse aggregate	1731	1701	1708
Fine aggregate	908	970	973
Chemical Admixture (oz/cwt)			
Sika	Type	Initial	Actual ^a
Air-260	Air-Entraining	0.21	0.28-0.33
Viscocrete-1000	High-Range Water-Reducing	2.5	1.75-2.75
Stabilizer-4R	Viscosity-Modifying	3	5

^a Actual values based on average of trip tickets.

Note: 1 lb/yd³ = 0.593 kg/m³, 1 oz/cwt = 0.652 mL/kg

The concrete properties and compressive strengths are provided in Table 2.20. During construction, slumps ranged from 3½ to 6 in. (90 to 150 mm), with an average of 4¾ in. (120 mm); air contents ranged from 7.4 to 11.2%, with an average of 8.9%. The slumps and air contents in the first three tests had an average value of 5¾ in. (145 mm) and 10.3%, respectively, exceeding the specification limits. Although none of the trucks were rejected, the supplier was urged to reduce the dosage of high-range water-reducing admixture as well as the water content in subsequent

batches. Concrete temperatures ranged from 58 to 70 °F (14 to 21 °C), with an average of 64 °F (18 °C) and 28-day compressive strengths ranged from 4750 to 6820 psi (32.8 to 42.4 MPa), with an average of 5540 psi (38.2 MPa).

Table 2.20: Average Concrete Test Results-MN-IC-LC-HPC-4

MN-IC-LC-HPC-4	Slump (in.)	Air content (%)	Concrete temperature (°F)	28-day compressive strength (psi)
Minimum	3½	7.4	58	4750
Maximum	6	11.2	70	6820
Average	4¾	8.9	64	5540

Note: 1 in. = 25.4 mm; °C = (°F-32)×5/9; 1 psi = 6.89×10⁻³ MPa

MN-IC-LC-HPC-4 was located approximately 15 minutes away from the ready-mix plant. Placement started on May 15, 2018, at 9:50 pm, at the east end of the deck, continued to the west end, and completed on May 16, 2018, by 6:00 am. The concrete was placed using two pumps positioned at opposite ends of the deck and consolidated using a single spud vibrator as the only method used throughout the deck. The concrete was finished using a double-drum roller screed, followed by metal pans and burlap drags. The concrete was placed in strips about 10 ft (3 m) along the length of the deck. During construction, wind speed ranged from 0 to 1 mph (0 to 1.6 km/hr), relative humidity from 37 to 58%, and ambient air temperature from 52 to 63 °F (11 to 17 °C), resulting in low evaporation rates, ranging from 0.02 to 0.03 lb/ft²/hr (0.08 to 0.15 kg/m²/hr), well below 0.2 lb/ft²/hr (1 kg/m²/hr), the maximum specification limit. The time between batching and discharge ranged from 15 to 39 minutes, with an average of 24 minutes. A 48-minute delay occurred during the construction due to the breakdown of the finishing machine. The time between placement and strike-off ranged from 10 to 48 minutes, with an average of 18 minutes.

The concrete appeared easily pumpable throughout construction and was able to flow in a continuous stream. Occasionally, however, construction personnel were observed stepping on areas that had been recently vibrated, causing disturbance to the concrete, as shown in Figure 2.7. These sections were later covered by the strike-off augers and subsequent paving roller instead of being reconsolidated. As discussed in Section 3.3.1.6, some short longitudinal and transverse cracks (crack lengths below 1 ft [305 mm]) were observed in these regions at an age of 48.7

months. The sidewalks received no finishing after being briefly consolidated by the spud vibrator and then covered with wet burlap.



Figure 2.7: Disturbance of Concrete Observed Near the North End

A single work bridge was used for bull floating, tining, and spraying curing compound on the deck, resulting in long delays between strike-off and application of curing compound. As discussed in Section 3.3.1.6, some surface damage was observed due to poor tining of the deck. The time between strike-off and application of curing compound ranged from 52 to 79 minutes. The sidewalks received only wet curing (wet burlap) within an hour after placement. KU researchers were informed that the roadway would be covered by wet burlap at dawn.

2.4.7 MN-IC-LC-HPC-5

MN-IC-LC-HPC-5 is a pedestrian bridge deck located at 40th St. over I-35W in Minneapolis. The deck was constructed in one placement on July 23, 2019. The concrete supplier and the contractor were Aggregate Industries U.S. and Lunda Construction Co., respectively. The bridge has two equal span lengths of 95 ft-9 in. (29.2 m), for a total length of 191 ft-6 in. (58.4 m).

The deck has a 14 ft (4.3 m) wide walkway, a 1 ft-5 in. (0.43 m) wide barrier on each side, for a total deck width of 16 ft-10 in. (5.1 m). The nominal deck thickness is 7 in. (178 mm); the deck is supported by prestressed concrete girders and has no skew.

The fine lightweight aggregate (LWA) used in MN-IC-LC-HPC-5 was an expanded clay stored in a garage at the ready-mix plant. The LWA was prewetted using a whirling sprinkler on top of the aggregate stockpile, as shown in Figure 2.8. The stockpile was approximately 7 ft (2.1 m) high, greater than the recommended 5-ft (1.5-m) limit. The whirling sprinkler was turned off on the morning of deck placement, letting the material drain approximately 11 hours prior to batching. At KU researchers' request, the LWA stockpile was turned several times before collecting a composite sample to measure the LWA absorption and free surface moisture prior to batching. When sampling the materials from the stockpile, KU researchers noticed some clumps of LWA, as shown in Figure 2.9. These clumps were removed from the samples before testing.

The average absorption (OD basis) and the specific gravity (OD basis) of the LWA obtained by KU researchers were 27.6% and 1.30, respectively, which differed from the values indicated in the original mixture proportions (30.2% and 1.27, respectively). Having a lower absorption than indicated can result in a lower than the intended quantity of internal curing water. KU researchers revised the mixture proportions to get 8% of internal curing water by the weight of binder.



Figure 2.8: Lightweight Aggregate Stockpile for MN-IC-LC-HPC-5



Figure 2.9: A Dense Clump of LWA Observed in the Stockpile for MN-IC-LC-HPC-5

Two trial batches were produced on July 23, 2019, based on the revised mixture proportions. Considering that the elapsed time for testing the concrete after batching was approximately 10 minutes and that the construction site was just 10 to 15 minutes away from the ready-mix plant, no haul time was considered. For the first trial batch, slump and air content were 3½ in. (90 mm) and 6%, respectively, with a concrete temperature of 76 °F (24 °C). The concrete supplier decided to increase the dosage of air-entraining admixture (from 0.5 oz/cwt to

0.75 oz/cwt) since the air content was lower than the minimum specified value by MnDOT IC-LC-HPC specifications (6.5%). Additionally, the concrete supplier decided to increase the dosage of the water-reducer admixture (from 1.25 oz/cwt to 1.75 oz/cwt) to slightly increase the slump. As a result, the second trial batch was made with the slump (5 in. [125 mm]), air content (8.2%), and concrete temperature (74 °F [23 °C]) within the specifications. A trial placement was not required due to successful construction of the MN-IC-LC-HPC-4, which had the same initial mixture proportions, concrete supplier, and contractor.

The initial, revised, and actual (based on the average of trip tickets) mixture designs submitted to MnDOT are listed in Table 2.21. MN-IC-LC-HPC-5 had identical mixture proportions as MN-IC-LC-HPC-4, with a design w/cm ratio of 0.43 and a 28% replacement of cement (by total weight of binder) with Grade 100 slag cement, and a design paste content of 26%. The design quantity of internal curing water was 8% (by the weight of binder). Based on the trip tickets, 8 lb/yd³ (5 kg/m³) of water was held from all the trucks, reducing the actual w/cm ratio to an average of 0.41. Prior to batching, KU researchers measured a total moisture content of 37.6% (of the LWA), while a total moisture content of 35.3% was determined and used by the ready-mix plant personnel. This deviation increased the mixing water and the w/cm by 3.9 lb/yd³ (2 kg/m³) and 0.007, respectively. Crushed gravel and river sand were used as coarse and fine aggregates, respectively. Based on the trip tickets, individual paste contents ranged from 25.2 to 25.5%, with an average of 25.3% and the actual quantities of IC water ranged from 7.9 to 8%, with an average of 8% by total weight of binder. The dosages of high-range water-reducing and viscosity-modifying admixtures were held constant throughout batching at 1.75 and 5 oz/cwt (1.1 and 3.3 mL/kg), respectively. A set-retarding admixture was added to some trucks per MnDOT Standard Specifications for Construction (2018), Section F.3.b(1). The specifications require that the contractor “place concrete at a rate that concrete will remain plastic for at least one-half a span length back of an intermediate support until placement has proceeded to a point one-half of the span length ahead of that support.” The set-retarding admixture was used to delay concrete setting to meet the requirement. As discussed later, during construction, the concrete setting was significantly delayed, resulting in delayed brooming and curing of the concrete.

Table 2.21: MN-IC-LC-HPC-5 Mixture Proportions (SSD/PSD Basis)

Material	Mixture proportions (lb/yd ³)		
	Initial	Revised	Actual ^a
Cement (Type I/II)	418	418	416
Grade 100 slag cement	164	164	165
Water	250	250	240
Fine lightweight aggregate	201	216	215
Coarse aggregate	1701	1701	1697
Fine aggregate	970	948	949
Chemical Admixture (oz/cwt)			
Sika	Type	Initial	Actual ^a
Air-260	Air-Entraining	0.1-3	0.6-0.75
Viscocrete-1000	High-Range Water-Reducing	0.1-3	1.75
Sikatard-440	Set-Retarding	0.1-8	0-1 ^b
Stabilizer-4R	Viscosity-Modifying	0.1-7	5

^a Actual values based on average of trip tickets.

^b Set retarder dosage stepped down from 1 to 0 oz/cwt throughout the placement.

Note: 1 lb/yd³ = 0.593 kg/m³, 1 oz/cwt = 0.652 mL/kg

The concrete properties and compressive strengths are listed in Table 2.22. Slumps ranged from 4 to 5½ in. (115 to 140 mm), with an average of 3¾ in. (95 mm), within the MnDOT specifications (2½ to 5½ in.). Two initial tests for air content were below 6.5%, the lower limit of the specifications. Therefore, a second test was performed for each, which showed air contents higher than 6.5%. Air contents ranged from 6.6 to 8.4%, with an average of 7.3%, within the specifications (6.5 to 10%). Concrete temperatures ranged from 75 to 80 °F (24 to 27 °C), with an average of 77 °F (25 °C), and 28-day compressive strengths ranged from 4750 to 6150 psi (32.8 to 42.4 MPa).

Table 2.22: Concrete Test Results-MN-IC-LC-HPC-5

MN-IC-LC-HPC-5	Slump (in.)	Air content (%)	Concrete temperature (°F)	28-day compressive strength (psi)
Minimum	4	6.6	75	4750
Maximum	5½	8.4	80	6150
Average	3¾	7.3	77	5320

Note: 1 in. = 25.4 mm; °C = (°F-32)×5/9; 1 psi = 6.89×10⁻³ MPa

The MN-IC-LC-HPC-5 was located approximately 10 minutes away from the ready-mix plant. Placement started on July 23, 2019, at 11:30 pm, at the west end of the deck, continued to the east end, and with the final strike-off being finished in the early morning of July 24, 2019, at 2:05 am. The concrete was placed using a pump, consolidated using a single spud vibrator, and finished using a vibrating screed, as shown in Figure 2.10. The concrete was placed in strips about 5 ft along the length of the deck. During placement, wind speeds at the deck ranged from 0 to 0.1 mph (0 to 0.2 km/hr). Relative humidity at the deck ranged between 54 and 80%. Ambient air temperature during construction ranged from 66 to 82 °F (19 to 28 °C). These environmental conditions resulted in relatively low evaporation rates, ranging from 0.02 to 0.03 lb/ft²/hr (0.09 to 0.15 kg/m²/hr), below the 0.2 lb/ft²/hr (1 kg/m²/hr) specifications limit. The time between batching and discharge ranged from 17 to 40 minutes, with an average of 30 minutes. The time between placement and strike-off ranged from 4 to 22 minutes, with an average of 8 minutes.



Figure 2.10: Placement, Consolidation, and Finishing of MN-IC-LC-HPC-5

Similar to consolidation observed during placements of other MN-IC-LC-HPC decks in Minnesota, the vibrator was inserted at regularly spaced intervals. Occasionally, however, construction personnel were observed stepping in areas that had been recently vibrated, as well as rapidly pulling out the vibrator from the concrete, leaving holes on the concrete surface, as shown in Figure 2.11. These actions have been observed to leave the concrete susceptible to settlement cracking (McLeod et al., 2009; Khajehdehi & Darwin, 2018). While KU personnel informed the MnDOT representative and construction personnel about this issue, the construction personnel opposed the argument. They believed that the vibrating screed would solve this problem. Crack survey results shown in Section 3.3.1.7 identified a number of transverse cracks along the entire deck; cracks that, as demonstrated in Chapter 5, do not appear on the other two pedestrian bridges in this study, MN-IC-LC-HPC-1 and MN-Control-1.

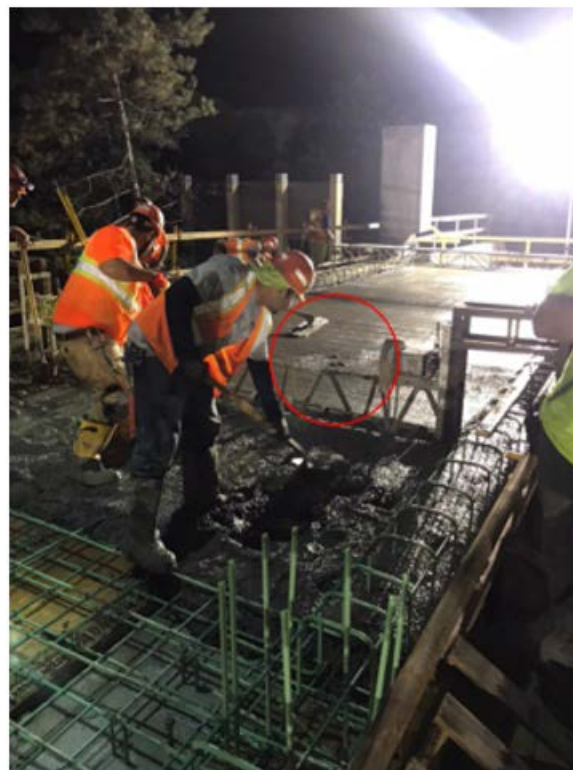

Figure 2.11: Holes in the Concrete Surface Duo to Rapid Removal of the Spud Vibrator

Significant bleed water was observed on the deck, as indicated by the reflective water sheen in Figure 2.12, which delayed brooming and curing. While waiting for bleed water to evaporate,

construction workers bull floated the deck repeatedly in an attempt to accelerate evaporation of the bleed water, leading to a thin paste layer with a high w/cm at the concrete surface. As discussed in Chapter 5, surface damage in the form of scaling is observed, which is likely the result of the over-finishing.

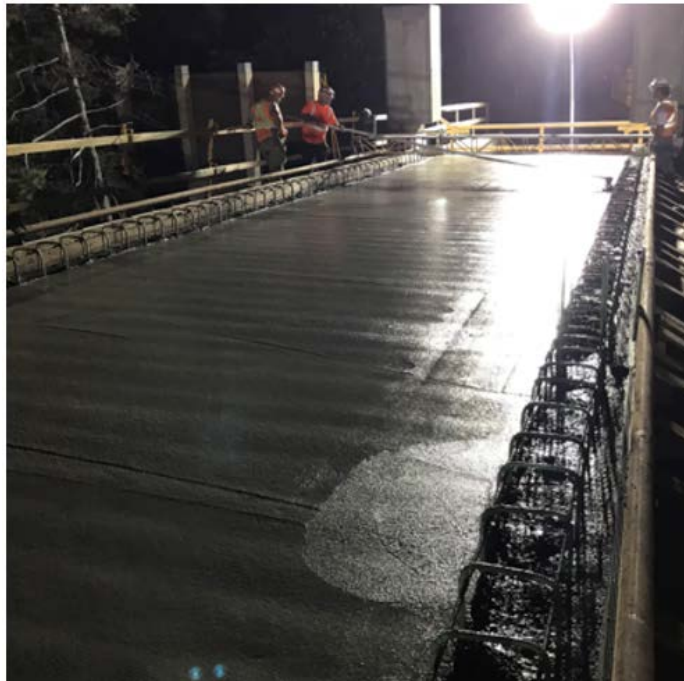

Figure 2.12: Presence of Bleed Water on the Surface

A transverse broom finish was applied in accordance with the MnDOT MN-IC-LC-HPC specifications for pedestrian decks. The contractor tried brooming the west end of the deck, which had a thin paste layer. The operation resulted in disturbance of the surface, as shown in Figure 2.13. Brooming a concrete deck when bleeding water is on the surface can lead to dusting and scaling damage. Brooming started around 2:15 am, after concrete placement was complete for the entire deck, and proceeded slowly due to the presence of bleed water.

Shortly after brooming, a single layer of curing compound was sprayed on the bridge deck. The application of the curing compound began at 3:00 am at the west end of the deck and finished at the east end of the deck at 3:55 am. The time between strike-off and application of the curing

compound ranged from 70 to 155 minutes. Figure 2.14 shows the completed deck prior to the application of wet curing using wet burlap, as described below.

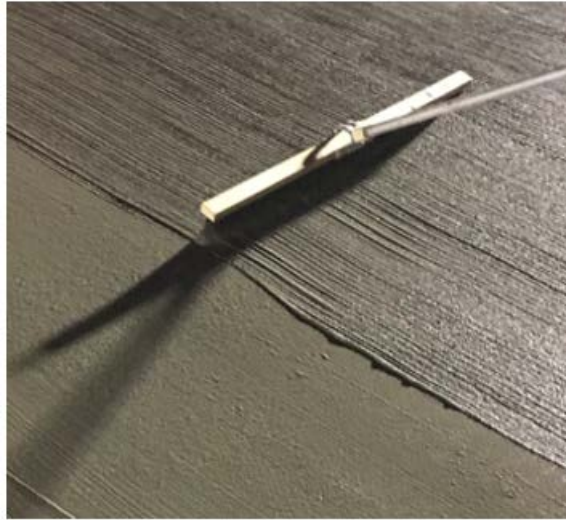

Figure 2.13: Brooming of the Deck with the Presence of Excess Water at the Surface



Figure 2.14: The Application of the Curing Compound on the Bridge Deck

Concrete adjacent to the barrier reinforcement on each side of the bridge did not receive any curing compound or finishing. Wet burlap, instead, was placed on these sections during construction within an hour of being consolidated, as shown in Figure 2.15.

KU researchers were informed that the bridge deck would be covered by wet burlap when the concrete could be walked on without producing imprints deeper than $\frac{1}{16}$ in. (1.6 mm). The burlap rolls were soaked in water for a minimum of 12 hours prior to the application, and then they were transferred to the work bridge for placing. According to the construction personnel, the application of wet burlap to the bridge began on the morning of July 24, 2019, at 6:00 am and completed within an hour.

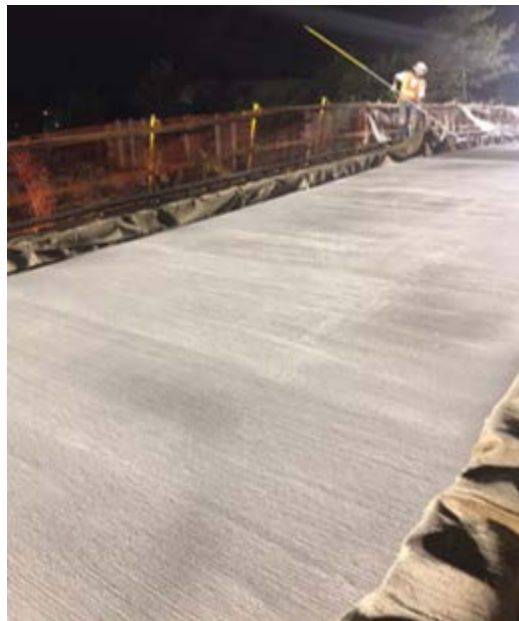

Figure 2.15: Burlap Placement on the Barrier Reinforcement

2.4.8 MN-IC-LC-HPC-6

MN-IC-LC-HPC-6 is a two-lane bridge that carries traffic on C.S.A.H. 7 over I-35W near Pine City. The deck was constructed in one placement on September 19, 2019. The concrete supplier and the contractor were Cemstone Products Co. and Ames Construction, respectively. The bridge has two equal span lengths of 94 ft (28.7 m), for a total length of 188 ft (57.4 m). The deck has a 49 ft (14.9 m) wide roadway with a 7 ft-10 in. (1.2 m) sidewalk on the north side, a 1 ft-5 in. (0.43 m) wide barrier on the north side, and a 1 ft-6 in. (0.46 m) wide barrier on the south side, for a total deck width of 59 ft-9 in. (18.2 m). The 6-in. (150-mm) thick sidewalk placed on the deck

at a later date did not incorporate IC. The nominal deck thickness is 9 in. (229 mm); the deck is supported by prestressed concrete girders and has a skew of 16° 2' 30".

The fine lightweight aggregate (LWA) used in MN-IC-LC-HPC-6 was an expanded clay stored in an open area at the ready-mix plant. The LWA was prewetted using a whirling sprinkler on top of the aggregate stockpile (Figure 2.16). The stockpile was approximately 8 ft (2.4 m) high, greater than the recommended 5-ft (1.5-m) limit. The whirling sprinkler was turned off due to overnight rain a day before the deck placement. Upon KU researchers' request, the LWA stockpile was turned several times before collecting a composite sample to measure the LWA absorption and free surface moisture prior to batching.



Figure 2.16: Lightweight Aggregate Stockpile for MN-IC-LC-HPC-6

The average absorption (OD basis) and the specific gravity (OD basis) of the LWA obtained by KU researchers were 32.9% and 1.21, respectively, which differed from the values indicated in the original mixture proportions (27.2% and 1.23, respectively). Having a higher absorption than indicated has the potential of holding excess water with the way moisture corrections are made and can lead to pumping issues and a lower than intended quantity of internal

curing water. KU researchers revised the mixture proportions to get 7% of internal curing water by the weight of binder.

KU researchers were not in attendance during a trial placement, an abutment used for the deck, on August 15, 2019. According to MnDOT representatives, the pour went well, with concrete properties within the specifications. On the day of batching, the concrete supplier decided to test the concrete for slump, air content, and temperature at the ready-mix plant before sending the first truck to the job site. For this batch, slump and air content were 4 in. (100 mm) and 7.6%, respectively, with a concrete temperature of 72 °F (22 °C), all within the specifications.

The initial, revised, and actual (based on the average of trip tickets) mixture designs submitted to MnDOT are listed in Table 2.23. MN-IC-LC-HPC-6 had a design w/cm ratio of 0.43 and a 30% replacement of cement (by total weight of binder) with Grade 100 slag cement, with a design paste content of 26%. The design quantity of internal curing water was 7% (by the weight of binder). Crushed granite and river sand were used as coarse and fine aggregates, respectively.

Although the mixture proportions were revised based on the findings of KU researchers on the LWA absorption and specific gravity, the concrete supplier mistakenly did not consider the absorbed water content of all aggregates prior to batching the materials. This resulted in a reduction in wet materials to be batched, lowering the cement paste, w/cm ratio, and quantity of IC water. The concrete in the first ten trucks was stiff, and the contractor had difficulty pumping it, a problem tied to both the incorrect batch weights and withholding a portion of mixing water. Although according to MnDOT specifications, after batching, no water is allowed to be added at the job site, 2.5 to 4.2 lb/yd³ (1.4 to 2.5 kg/m³) of water, respectively, was added to the first and the second trucks at the job site. Additionally, the concrete supplier added either 5 or 8 lb/yd³ (3 or 5 kg/m³) of water to three truckloads at the ready-mix plant. Based on the trip tickets, between 8 to 17 lb/yd³ (5 to 10 kg/m³) of water was withheld from the trucks (17 lb/yd³ [10 kg/m³] from the first eight trucks and thirty-eighth truck, 13 lb/yd³ [7 kg/m³] from ninth and tenth trucks, and 8 lb/yd³ [5 kg/m³] from the rest of them), reducing the actual w/cm ratio to an average of 0.40.

Based on the trip tickets, individual paste contents ranged from 24.5 to 25.2%, with an average of 25.0% and the actual quantities of IC water ranged from 4.9 to 5.6%, with an average of 5.2% by total weight of binder. A mid-range water-reducing admixture (MRWRA) with a

dosage of either 3 or 4 oz/cwt (2 or 2.6 mL/kg) was added to the concrete. A set-retarding admixture was also added to some trucks. The dosage of a viscosity-modifying admixture was held constant throughout batching at 4 oz/cwt (2.6 mL/kg). KU researchers observed no excessive bleed water on the surface of the deck.

Table 2.23: MN-IC-LC-HPC-6 Mixture Proportions (SSD/PSD Basis)

Material	Mixture proportions (lb/yd ³)		
	Initial	Revised	Actual ^a
Cement (Type I/II)	406	406	406
Grade 100 slag cement	174	174	174
Water	248	248	232
Fine lightweight aggregate	192	164	122
Coarse aggregate	1641	1641	1631
Fine aggregate	1096	1092	1084
Chemical Admixture (oz/cwt)			
BASF	Type	Initial	Actual ^a
Air AE 90	Air-Entraining	0.1-10	3-8
Polyheed 1020	Water-Reducing	1-12	3-4
Set Delvo	Set-Retarding	0-5	0-1 ^b
Matrix VMA 358	Viscosity-Modifying	0-6	4

^a Actual values based on average of trip tickets.

^b Set retarder dosage stepped down from 1 to 0 oz/cwt throughout the placement.

Note: 1 lb/yd³ = 0.593 kg/m³, 1 oz/cwt = 0.652 mL/kg

The concrete properties and compressive strengths are listed in Table 2.24. Four tests for slump, air content, and temperature were performed. Slumps ranged from 3 to 3¾ in. (75 to 95 mm), with an average of 3½ in. (90 mm), within the specifications (1½ to 5 in. [38 to 127 mm]). For the first truck at the job site, an initial test for air content was 6%, below the lower limit of the specifications. The dosage of the air-entraining admixture was then adjusted to increase the air content slightly. A second test was performed on this load, which showed an air content of 7.6%. Air contents ranged from 6.8 to 9.2%, with an average of 7.9%, within the specifications (6.5 to 10%). Concrete temperatures ranged from 65 to 78 °F (18 to 26 °C), with an average of 71 °F (22 °C), and 28-day compressive strengths ranged from 5310 to 7680 psi (36.6 to 52.9 MPa).

Table 2.24: Concrete Test Results-MN-IC-LC-HPC-6

MN-IC-LC-HPC-6	Slump (in.)	Air content (%)	Concrete temperature (°F)	28-day compressive strength (psi)
Minimum	3	6.8	65	5310
Maximum	3¾	9.2	78	7680
Average	3½	7.9	71	6490

Note: 1 in. = 25.4 mm; °C = (°F-32)×5/9; 1 psi = 6.89×10⁻³ MPa

The MN-IC-LC-HPC-6 was located approximately 5 minutes away from the ready-mix plant. Placement started on September 19, 2019, at 6:25 am, at the west end of the deck, continued to the east end, and with the final strike-off being finished the same morning at 11:57 am. The concrete was placed using two pumps positioned at opposite ends of the deck (one with a smaller diameter used on one-third of the deck) and consolidated using a single spud vibrator. The roadway was finished using a double-drum roller screed followed by two metal pans and a burlap drag and cured with a layer of curing compound. The sidewalk concrete, however, was only consolidated, with no finishing or application of curing compound. Both the roadway and sidewalk received wet curing. Figure 2.17 shows the placing, consolidation, and finishing equipment of the MN-IC-LC-HPC-6 construction.

No significant issues arose during concrete pumping, placement, or finishing. The concrete was placed in strips about 5 ft (1.5 m) along the length of the deck. Similar to consolidation observed during placements of other MN-IC-LC-HPC decks in Minnesota, the vibrator was inserted at regularly spaced intervals. Occasionally, however, construction personnel were observed stepping in concrete that had been previously vibrated, shoveling concrete, causing deconsolidation and disturbance of the concrete, as shown in Figure 2.18; crack surveys at an age of 32.2 months, discussed in Section 3.3.1.8, however, did not identify any cracks in these regions.



Figure 2.17: Placing, Consolidation, and Finishing Equipment



Figure 2.18: Walking Through Consolidated Concrete

A highway straightedge was used in place of a bull float. The deck was tined about 10 minutes after bull floating, before the application of the curing compound, as shown in Figure 2.19. As discussed in Section 3.3.1.8, the deck was heavily tined, disrupting the aggregates near the upper surface. Shortly after tining, a single layer of curing compound was unevenly sprayed on the roadway, as shown in Figure 2.20. The application of the curing compound began at the west end and continued to the east end of the deck.

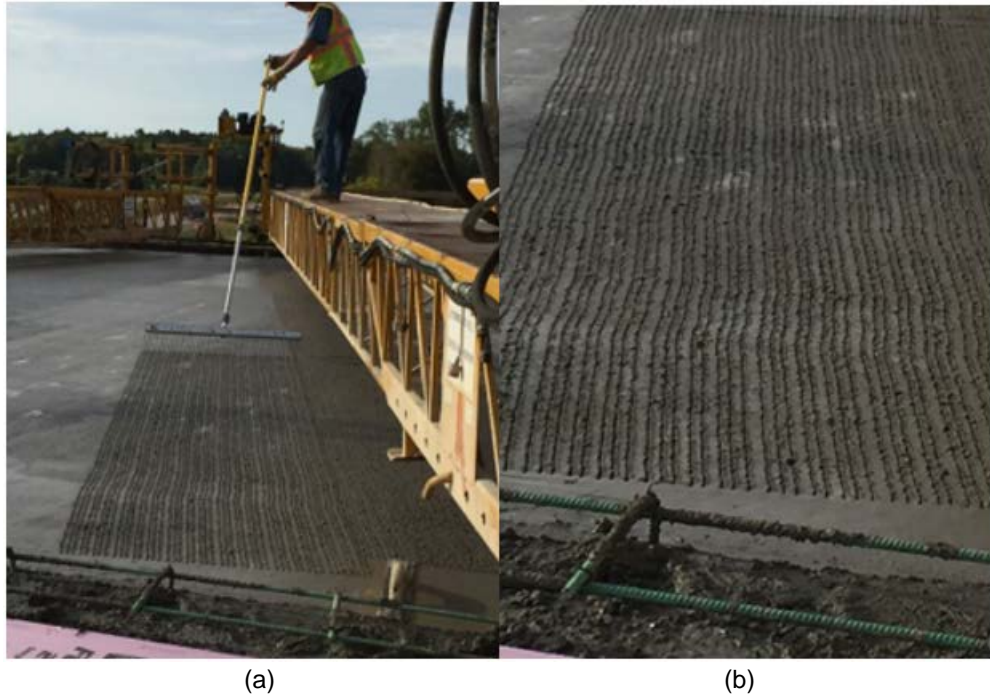

Figure 2.19: Tining of the Deck (a) An Overview; (b) A Close-Up View

During placement, wind speeds at the deck ranged from 0 to 0.8 mph (0 to 1.3 km/hr). Relative humidity at the deck ranged between 68.2 and 78.9%. Ambient air temperature during construction ranged from 68 to 75 °F (20 to 24 °C). These environmental conditions resulted in relatively low evaporation rates, ranging from 0.01 to 0.02 lb/ft²/hr (0.05 to 0.09 kg/m²/hr), below the 0.2 lb/ft²/hr (1 kg/m²/hr) specifications limit. The time between batching and discharge ranged from 10 to 50 minutes, with an average of 26 minutes. The time between placement and strike-off for the roadway ranged from 2 to 31 minutes, with an average of 7 minutes. Two work bridges were used for bull floating, tining, and applying the curing compound. The time between strike-off and bull floating ranged from 14 minutes to 35 minutes, with an average of 22 minutes. The average time between bull floating and tining ranged from 25 to 50 minutes, with an average of 39 minutes. The time between tining and curing compound application ranged from 5 to 48 minutes, with an average of 15 minutes.



Figure 2.20: The Application of the Curing Compound on the Roadway of the Deck Showing Uneven Coverage

2.4.9 MN-IC-LC-HPC-7

MN-IC-LC-HPC-7 is a two-way bridge that carries traffic on Dale St. over I-35 in St. Paul. The deck was constructed in two placements: each placement one-half of the total deck width, dividing the deck into east and west sides from the centerline of the roadway. The first placement (MN-IC-LC-HPC-7-P1) was constructed on June 24, 2020, starting from the north end of the deck. Placement 1 was completed by placing approximately 390 yd³ (298.2 m³) of concrete on the deck. The remaining portion of the deck (MN-IC-LC-HPC-7-P2) was completed on September 22, 2020. The concrete supplier and the contractor for both placements were Cemstone Products Co. and Redstone Construction, respectively. The bridge has two equal span lengths of 89 ft-11½ in. (27.4 m), for a total length of 179 ft-11 in. (54.8 m). The deck has a 76 ft (23.2 m) wide roadway, and a 16 ft (4.9 m) sidewalk on each side, for a total deck width of 113 ft-4 in. (34.5 m). The nominal deck thickness is 9 in. (229 mm). The bridge deck is supported by prestressed concrete girders with a skew of 2° 24' 38".

The fine lightweight aggregate (LWA) used for both placements was an expanded clay stored in an open area at the ready-mix plant. The LWA was prewetted using an oscillating sprinkler near the aggregate stockpile on the ground. The stockpile was approximately 7 ft (2.1 m) high, greater than the recommended 5-ft (1.5-m) limit, as shown in Figure 2.21.



Figure 2.21: MN-IC-LC-HPC-7 Lightweight Aggregate Stockpile

KU personnel were not in attendance during the trial batches for this project on June 18, 2020. According to the concrete supplier, two truckloads (with 7 yd³ [5.4 m³] of concrete each) were produced; the concrete properties were within the specifications, with air contents of 9.5 and 9.1%, slumps between 3 and 4 in. (75 and 100 mm), and concrete temperatures of 78 and 80 °F (26 and 27 °C).

The concrete supplier for the deck proposed the same mixture proportions as the one used for MN-IC-LC-HPC-6 in Pine City in 2019. KU researchers traveled to St. Paul and worked with the concrete supplier to determine the LWA properties and provide adjustments in the mixture proportions to maintain the desired quantity of internal curing water before batching the concrete. The mixture had a binary binder composition, a 30% replacement by weight of portland cement with slag cement. The design paste content and the water-cementitious material (*w/cm*) ratio were 25.9% (by concrete volume) and 0.43, respectively. The design quantity of IC water was 7% (by the weight of binder). The design LWA absorption and specific gravity values were 32.9% and 1.21 (OD basis), respectively.

2.4.9.1 MN-IC-LC-HPC-7-P1

Placement 1 of the MN-IC-LC-HPC-7 was constructed on June 24, 2020. The LWA stockpile was prewetted for at least three days before batching. The sprinkler was turned off on

the morning of June 24, 2020, letting the material drain for approximately 15 hours prior to batching. Upon KU researchers' request, the LWA stockpile was turned several times before collecting a composite sample to measure the LWA absorption and free-surface moisture prior to batching. The average absorption (OD basis) and the specific gravity (OD basis) of the LWA obtained by KU researchers were 34% and 1.20, respectively, which differed slightly from the values indicated originally in the mixture proportions. KU researchers revised the mixture proportions to get 7% of IC water by the weight of binder. The initial and actual (based on the average of trip tickets) mixture proportions for the first placement of MN-IC-LC-HPC-7 are listed in Table 2.25. Crushed granite and river sand were used as coarse and fine aggregates, respectively, in both placements.

Based on the trip tickets, between 8 and 21 lb/yd³ (5 and 12 kg/m³) of water was withheld during batching, reducing the actual *w/cm* ratio to an average of 0.41. Additionally, prior to casting, KU personnel measured a free-surface moisture of 9.2%, while a free-surface moisture of either 8 or 11.5% was determined and used by the ready-mix plant personnel. This deviation slightly decreased the mixing water and the *w/cm* by 1 lb/yd³ (0.6 kg/m³) and 0.001, respectively. Based on the trip tickets, individual *w/cm* ratios ranged from 0.40 to 0.43, paste contents ranged from 25.0 to 25.7%, with an average of 25.4% and the actual quantities of IC water ranged from 6.6 to 10.5%, with an average of 7.1% by total weight of binder. An air-entraining admixture was added at a varied dosage between 0.9 and 1.2 oz/cwt (0.6 and 0.8 mL/kg). A mid-range water-reducing admixture (MRWRA) with a dosage of 5 oz/cwt (3.3 mL/kg) was added to all truckloads. A set-retarding admixture with varied dosages between 1 and 3 oz/cwt (0.7 and 2 mL/kg) was also added to all truckloads. The dosages of viscosity-modifying and workability-retaining admixtures were held constant throughout batching at 3 and 1 oz/cwt (2 and 0.7 mL/kg), respectively.

The concrete properties and compressive strengths are listed in Table 2.26. Seven tests for slump, air content, and temperature were performed. Slumps ranged from 4 to 4¾ in. (100 to 120 mm), with an average of 4½ in. (115 mm), within the specifications. One initial test for air content was above 10%, the maximum limit of the specifications. Therefore, a second test was performed, which also showed an air content of 10%. Air contents ranged from 7.5 to 10%, with an average of 8.9%, within the specifications. Concrete temperatures ranged from 71 to 75 °F (22

to 24 °C), with an average of 73 °F (23 °C), and 28-day compressive strengths ranged from 5470 to 7310 psi (37.7 to 50.4 MPa).

Table 2.25: MN-IC-LC-HPC-7-P1 Mixture Proportions (SSD/PSD Basis)

Material	Mixture proportions (lb/yd ³)		
	Initial	Revised	Actual ^a
Cement (Type I/II)	406	406	406
Grade 100 slag cement	174	174	173
Water	248	248	239
Fine lightweight aggregate	164	159	163
Coarse aggregate	1641	1643	1637
Fine aggregate	1092	1098	1095
Chemical Admixture (oz/cwt)			
BASF	Type	Initial	Actual ^a
Air AE 90	Air-Entraining	0.1-10	0.9-1.2
Polyheed 1020	Mid-Range Water-Reducing	1-12	5
Set Delvo	Set-Retarding	0-5	1-3 ^b
Matrix VMA 358	Viscosity-Modifying	0-6	3
Sure Z 60	Workability Retaining	- ^c	1

^a Actual values based on average of trip tickets.

^b Set retarder dosage stepped down from 3 to 1 oz/cwt throughout the placement.

^c The dosage was not indicated.

Note: 1 lb/yd³ = 0.593 kg/m³, 1 oz/cwt = 0.652 mL/kg

Table 2.26: Concrete Test Results-MN-IC-LC-HPC-7-P1

MN-IC-LC-HPC-7-P1	Slump (in.)	Air content (%)	Concrete temperature (°F)	28-day compressive strength (psi)
Minimum	4	7.5	71	5470
Maximum	4¾	10	75	7310
Average	4½	8.9	73	6630

Note: 1 in. = 25.4 mm; °C = (°F-32)×5/9; 1 psi = 6.89×10⁻³ MPa

The MN-IC-LC-HPC-7 was located approximately 10 minutes away from the ready-mix plant. Placement 1 started on June 24, 2020, at 10:15 pm, at the north end of the deck and continued to the south end, with the final strike-off on June 25, 2020, at 4:25 am. The concrete was placed

using two pumps (the first pump was positioned near the north end, and the second pump was located near the south end of the bridge). The roadway was consolidated using a spud vibrator and finished by a double-drum roller screed. The sidewalk was consolidated by a spud vibrator followed by a vibrating screed, as shown in Figure 2.22.

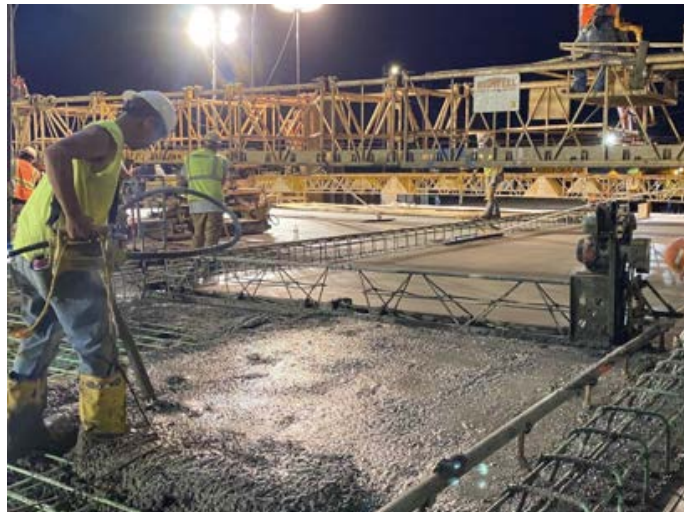

Figure 2.22: Placement Equipment

During placement, wind speeds at the deck ranged from 0 to 0.6 mph (0 to 1 km/hr). Relative humidity at the deck ranged between 59.8 and 80.1%. Ambient air temperature during construction ranged from 61 to 70 °F (16 to 21 °C). These environmental conditions resulted in evaporation rates, ranging from 0.02 to 0.03 lb/ft²/hr (0.09 to 0.14 kg/m²/hr), below the 0.2 lb/ft²/hr (1 kg/m²/hr) specifications limit.

No significant issues arose during concrete pumping, placement, or finishing. The time between batching and discharge ranged from 22 to 33 minutes, with an average of 28 minutes. Occasionally, construction personnel were observed stepping in concrete that had been recently vibrated, shoveling concrete, causing deconsolidation and disturbance of the concrete, as shown in Figure 2.23. As will be described in Section 3.3.1.9, some cracks with lengths below 6 in. (152.4 mm) and widths between 0.002 in. to 0.006 in. (0.05 to 0.15 mm) were observed mostly on the roadway within 5 ft (1.5 m) from the barrier in these regions. As discussed in Section 2.4.7, the loss of consolidation can lead to settlement, which can lead to increased cracking (Khajehdehi

& Darwin, 2018). The time between placement and strike-off for the sidewalk ranged from 2 to 17 minutes, with an average of 5 minutes; the time between placement and strike-off for the roadway ranged from 13 to 41 minutes, with an average of 25 minutes.



Figure 2.23: Walking Observed on Freshly Consolidated Concrete

One work bridge was used for bull floating, and one work bridge was used for the application of curing compound (including on the sidewalk) and placing wet burlap on the roadway. Trowels were used to finish the edges, concrete adjacent to the barrier reinforcement on each side, and near abutments. Shortly after the bull floating, the concrete was broomed. Due to using a single work bridge for the application of curing, the contractor decided to initiate the application of curing for both roadway and sidewalk at the same time. With the appearance of bleed water on the concrete surface, as indicated by the reflective water sheen in Figure 2.24(a), the contractor stopped applying the curing compound on the sidewalk and placed wet burlap on the roadway. This incident resulted in a long delay between strike-off and curing application, mostly near the abutments and the central pier. While waiting for the bleed water to disappear, the construction workers bull floated the deck repeatedly at some locations in an attempt to accelerate the evaporation of bleed water, as shown in Figure 2.24. As discussed in Section 2.4.7, over-finishing may result in map cracking by bringing excess paste to the surface (Pendergrass &

Darwin, 2014). As discussed in Section 3.3.1.9, no map cracking was observed on the deck through the first two years of crack surveys. The tendency to exhibit cracking over the long term, however, usually becomes apparent only after 36 months (Lindquist et al., 2008; Yuan et al., 2011; Pendergrass & Darwin, 2014).

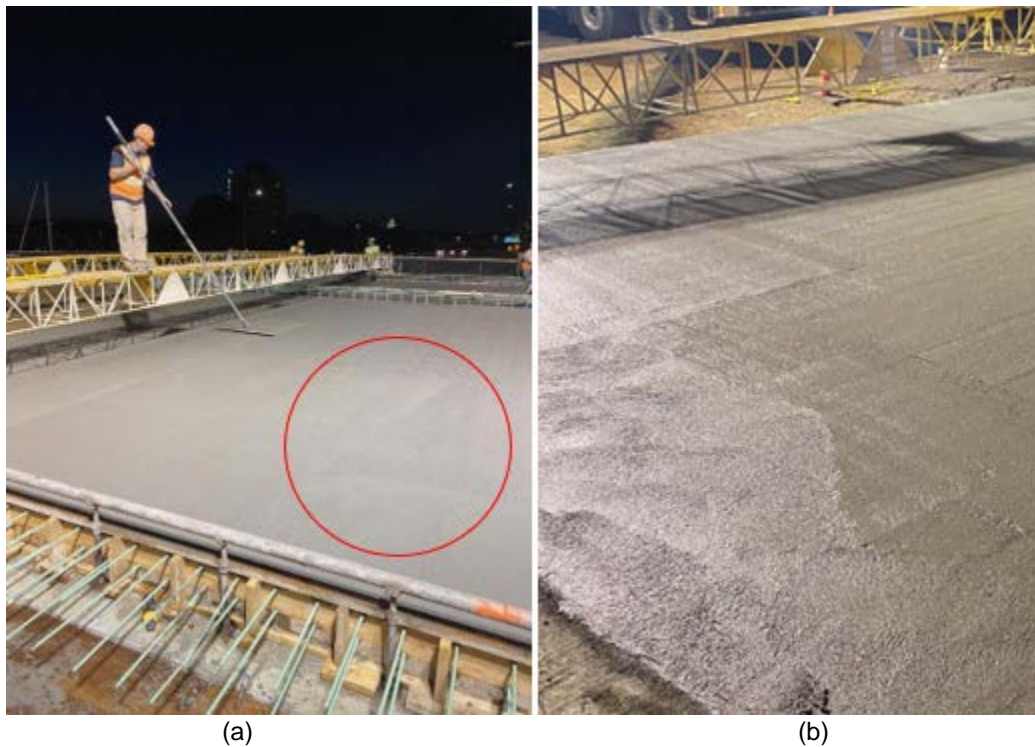

Figure 2.24: Bull Floating the Deck in the Presence of Bleed Water (a) An Overview; (b) A Close-Up View

For the sidewalk, the time between strike-off and application of curing compound ranged from 68 to 112 minutes; for the roadway, the time between strike-off and placing wet burlap ranged from 32 to 67 minutes. Figure 2.25 shows the application of curing on both the roadway and sidewalk of the deck.

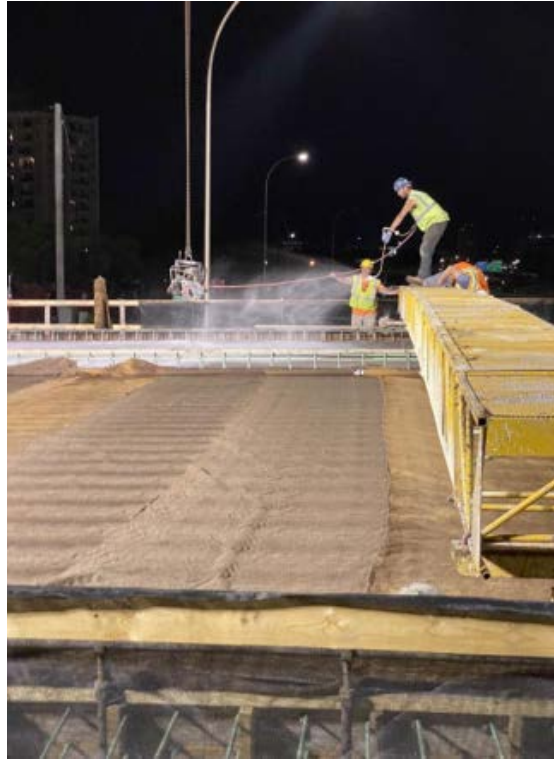

Figure 2.25: The Application of Curing on MN-IC-LC-HPC-7-P1

2.4.9.2 MN-IC-LC-HPC-7-P2

Placement 2 of MN-IC-LC-HPC-7 was constructed on September 22, 2020. A new shipment of LWA was delivered to the ready-mix plant. The LWA stockpile was approximately 8 ft (2.4 m) high, and it was prewetted for at least three weeks before batching. The sprinkler was turned off on September 22, 2020, at 11:00 am, letting the material drain approximately 9 hours prior to batching. A composite sample was obtained to measure the LWA absorption and free-surface moisture prior to batching. The absorption and the specific gravity of the LWA (OD basis) obtained by KU and MnDOT personnel were 35.1% and 1.20, respectively. KU researchers revised the mixture proportions to get 7% of IC water per weight of binder.

The initial and actual (based on the average of trip tickets) mixture proportions for the second placement of MN-IC-LC-HPC-7 are listed in Table 2.27. Based on the trip tickets, between 8 and 17 lb/yd³ (5 and 10 kg/m³) of water was withheld during batching, reducing the actual *w/cm* ratio to an average of 0.41. Additionally, prior to casting, KU personnel measured a free-surface moisture of 4.9%, while a free-surface moisture of either 5.5 or 0% was determined and used by

the ready-mix plant personnel. Based on the trip tickets, individual w/cm ratios ranged from 0.39 to 0.42, paste contents ranged from 24.9 to 25.5%, with an average of 25.3% and the actual quantities of IC water ranged from 6.8 to 8.2%, with an average of 7.0% by total weight of binder. An air-entraining admixture was added at a constant dosage of 0.9 oz/cwt (0.6 mL/kg). A mid-range water-reducing admixture (MRWRA) with a dosage of 4 oz/cwt (2.6 mL/kg) was added to all truckloads; a set-retarding admixture with a constant dosage of 1 oz/cwt (0.7 mL/kg) was also added to all truckloads. The dosages of viscosity-modifying and workability-retaining admixtures were held constant throughout batching at 3 and 1 oz/cwt (2 and 0.7 mL/kg), respectively.

The concrete properties and compressive strengths are listed in Table 2.28. In contrast with the construction of the first placement, the concrete properties were, for the most part, measured before pumping because MnDOT personnel observed a no loss slump and just a 1% air loss due to pumping; therefore, except for one test, slumps were measured before pumping and ranged from 1 to 4¼ in. (25 to 105 mm), with an average of 3½ in. (90 mm). The single slump measured after pumping equaled 3¾-in. (95-mm). Similarly, except for three tests, air contents were measured before pumping and ranged from 7.5 to 8.5%, with an average of 8.2%, within the specifications (6.5 to 10%). With the exception of one test (air content of 5.5% after pumping), the two air contents measured after pumping had an air content of 7.5% each. Concrete temperatures ranged from 69 to 76 °F (21 to 24 °C), with an average of 73 °F (23 °C), and 28-day compressive strengths ranged from 4080 to 6950 psi (28.1 to 47.9 MPa).

Table 2.27: MN-IC-LC-HPC-7-P2 Mixture Proportions (SSD/PSD Basis)

Material	Mixture proportions (lb/yd ³)		
	Initial	Revised	Actual ^a
Cement (Type I/II)	406	406	406
Grade 100 slag cement	174	174	173
Water	248	248	237
Fine lightweight aggregate	164	156	156
Coarse aggregate	1641	1643	1637
Fine aggregate	1092	1105	1103
Chemical Admixture (oz/cwt)			
BASF	Type	Initial	Actual ^a
Air AE 90	Air-Entraining	0.1-10	0.9
Polyheed 1020	Mid-Range Water-Reducing	1-12	4
Set Delvo	Set-Retarding	0-5	1
Matrix VMA 358	Viscosity-Modifying	0-6	3
Sure Z 60	Workability Retaining	- ^b	1

^a Actual values based on average of trip tickets.

^b The dosage was not indicated.

Note: 1 lb/yd³ = 0.593 kg/m³, 1 oz/cwt = 0.652 mL/kg

Table 2.28: Concrete Test Results^a-MN-IC-LC-HPC-7-P2

MN-IC-LC-HPC-7-P2	Slump (in.)	Air content (%)	Concrete temperature (°F)	28-day compressive strength (psi)
Minimum	1	7.5	69	4080
Maximum	4¼	8.5	76	6950
Average	3½	8.2	73	5830

^a Values measured before pumping; cylinders were filled from truck discharge.

Note: 1 in. = 25.4 mm; °C = (°F-32)×5/9; 1 psi = 6.89×10⁻³ MPa

Placement 1 started on September 24, 2020, at 8:45 pm, at the south end of the deck and continued to the north end, with final strike-off on September 25, 2020, at 2:20 am. As with the first placement, the concrete was placed using two pumps positioned at opposite ends of the deck. The roadway was consolidated using a spud vibrator and finished by a double-drum roller screed. The sidewalk, however, was consolidated by a spud vibrator followed by a vibrating screed.

During placement, wind speeds at the deck ranged from 0 to 2.3 mph (0 to 3.7 km/hr). Relative humidity at the deck ranged between 52.7 and 61.7%. Ambient air temperature during construction ranged from 70 to 79 °F (21 to 26 °C). These environmental conditions resulted in evaporation rates ranging from 0.02 to 0.05 lb/ft²/hr (0.09 to 0.24 kg/m²/hr), below the 0.2 lb/ft²/hr (1 kg/m²/hr) specifications limit.

No significant issues arose during concrete pumping, placement, or finishing. During the placement, KU personnel, however, did observe trapped air pockets on the finished surface of the concrete, mainly near the south end abutment. “Air pockets” result in small openings through which water and fines appear on the concrete surface. Examples are shown in Sections 2.4.10 and 2.4.11.

The time between placement and strike-off for the sidewalk ranged from 4 to 32 minutes, with an average of 7 minutes; the time between placement and strike-off for the roadway ranged from 14 to 50 minutes, with an average of 27 minutes.

Similar to the construction of the first placement, long delays occurred between strike-off and the application of curing compound and burlap due to the presence of bleed water on the surface. As described in Section 3.3.1.9, cracks with lengths below 6 in. (152.4 mm) and widths between 0.003 to 0.025 in. (0.08 to 0.64 mm) were observed primarily on the roadway within 5 ft (1.5 m) of the barrier in these regions. For the sidewalk, the time between strike-off and curing compound ranged from 105 to 150 minutes; for the roadway, the time between strike-off and placing wet burlap ranged from 75 to 135 minutes.

2.4.10 MN-IC-LC-HPC-8

MN-IC-LC-HPC-8 is a two-lane bridge that carries traffic on C.S.A.H. 12 over I-90 in Winona. The deck was constructed in one placement on August 20, 2020. The concrete supplier and the contractor were Modern Ready Mix Inc. and Icon Constructors, respectively. The bridge has two equal span lengths of 114 ft-6½ in. (34.9 m), for a total length of 229 ft-1 in. (69.8 m). The deck has a 36 ft (10.9 m) wide roadway and a 1 ft-6 in. (0.46 m) wide barrier on each side, for a total deck width of 39 ft (11.9 m). The nominal deck thickness is 9 in. (229 mm); the deck is supported by prestressed concrete girders with a skew of 4° 6’ 7”.

The fine lightweight aggregate (LWA) used in MN-IC-LC-HPC-8 was an expanded clay stored in an open area at the ready-mix plant. The LWA was prewetted using a lawn sprinkler on top of the aggregate stockpile for at least two weeks prior to the construction date. The stockpile was approximately 7 ft (2.1 m) high, greater than the recommended 5-ft (1.5-m) limit. The sprinkler was turned off on the evening of August 19, 2020, letting the material drain approximately 12 hours prior to batching. Upon KU researchers' request, the LWA stockpile was turned several times before collecting a composite sample to measure the LWA absorption and free surface moisture prior to batching.

Three trial placements were completed before the construction of MN-IC-LC-HPC-8. The first trial placement was completed on August 12, 2020, with no KU personnel in attendance. The mixture had a binary binder composition, a 30% replacement by weight of portland cement with Grade 100 slag cement. The design paste content and the w/cm ratio were 25.6% (by concrete volume) and 0.43, respectively. The design quantity of internal curing water was 8% (by the weight of binder). The lightweight aggregate was prewetted for more than two weeks prior to batching, and the design absorption value was 30% (OD basis). The air content and slump of the concrete were 8.4% and 4 in. (100 mm) after pumping, respectively. Although the concrete properties were within MnDOT specifications, there were concerns regarding placement and finishing of the concrete. During the trial placement, MnDOT personnel observed bleeding water channeling, as well as the appearance of trapped air pockets on the finished surface of the concrete, as shown in Figure 2.26. Additional bleeding water pockets appeared for at least 1½ hours after placement. The contractor also had difficulties in finishing the concrete. KU researchers and MnDOT representatives held an online meeting on August 17, 2020, to discuss the issues arisen during the trial placement. At the meeting, KU researchers recommended reducing the dosage of set retarding admixture in the mixture proportions as well as providing on-site guidance to provide moisture content correctly.



Figure 2.26: The Appearance of Air Pockets on the Concrete Surface (Image Provided by MnDOT)

A second trial placement was completed at the ready-mix plant on August 18, 2020, with KU and MnDOT personnel in attendance. The concrete was placed in a box with dimensions of 2×4 ft (0.3×0.6 m) with a depth of 2 ft (0.3 m) (Figure 2.27). The average absorption (OD basis) and the specific gravity (OD basis) of the LWA obtained by KU researchers were 31.1% and 1.27, respectively, which slightly differed from the values indicated in the original mixture proportions (30.0% and 1.40, respectively). KU researchers revised the mixture proportions and also provided free-surface moisture to the concrete supplier prior to batching. The concrete supplier also reduced the dosage of the set retarding admixture by half. Two truckloads (each 3 yd^3 [2.3 m^3]) of concrete were made based on these adjustments at the ready-mix plant, one without and one with set retarding admixture. The air content and slump in the first truck, which contained no set retarding admixture, were 7.5% and $3\frac{1}{2}$ in. (90 mm), respectively, after approximately 30 minutes of haul time. The air content and slump in the second truck, which contained 1.5 oz/cwt of set retarding admixture, were 8% and $5\frac{1}{2}$ in. (140 mm), respectively. Both truckloads were placed successfully without any issues, as shown in Figure 2.27.



Figure 2.27: Placement of Second Truckload in Second Trial Placement (Containing Set Retarding Admixture) with No Observable Air Pockets on the Concrete Surface

A third trial placement was completed at the job site on August 19, 2020, with KU and MnDOT personnel in attendance. The concrete was placed in a larger box than in the second trial placement. The concrete properties at the job site were within MnDOT specifications, except for the slump, which was 5½ in. (140 mm). Small, trapped air pockets appeared on the surface of the concrete, as shown in Figure 2.28, but MnDOT personnel approved the trial placement.

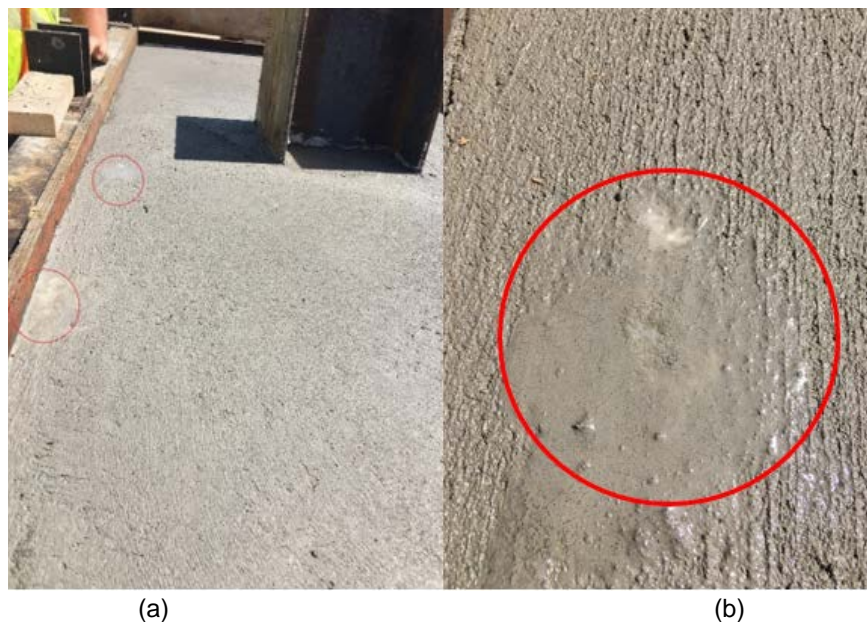

Figure 2.28: Small, Trapped Air Pockets at Edges of Third Trial Placement (a) Overview; (b) Close-Up (Image Provided by MnDOT)

The initial, revised, and actual (based on the average of trip tickets) mixture proportions submitted to MnDOT are listed in Table 2.29. MN-IC-LC-HPC-8 had a design w/cm ratio of 0.43 and a 30% replacement of cement (by total weight of binder) with Grade 100 slag cement, with a design paste content of 25.6%. The design quantity of internal curing water was 8% (by the weight of binder).

Table 2.29: MN-IC-LC-HPC-8 Mixture Proportions (SSD/PSD Basis)

Material	Mixture proportions (lb/yd ³)		
	Initial	Revised	Actual ^a
Cement (Type I/II)	400	400	400
Grade 100 slag cement	170	170	171
Water	245	245	239
Fine lightweight aggregate	194	192	193
Coarse aggregate	1583	1583	1579
Fine aggregate	1099	1074	1071
Chemical Admixture (oz/cwt)			
BASF	Type	Initial	Actual ^a
Air AE 90	Air-Entraining	- ^b	0.99
Polyheed 1020	Water-Reducing	1-12	6
Set Delvo	Set-Retarding	0-5	1.5
Matrix VMA 358	Viscosity-Modifying	0-10	Not used

^a Actual values based on average of trip tickets.

^b As needed.

Note: 1 lb/yd³ = 0.593 kg/m³, 1 oz/cwt = 0.652 mL/kg

Based on the trip tickets, between 13 and 34 lb/yd³ (8 and 20 kg/m³) of water was initially withheld from the trucks, resulting in very stiff concretes with w/cm ratios as low as 0.37. Therefore, the concrete supplier added a portion of the withheld water ranging from 3 to 25 lb/yd³ (2 to 15 kg/m³) to the trucks at the ready-mix plant. MnDOT inspectors also had difficulties tracking the amount of water in the trucks, and the concrete supplier added undocumented water (approximately 21 lb/yd³ [12 kg/m³]) at the jobsite. The MnDOT inspector believed that some trucks were not emptying their drums of wash water before getting a new load, as the specification

requires, and adjustments were made at the batch plant to compensate for that water, resulting in the actual *w/cm* ratio averaging close to 0.42.

Crushed gravel and river sand were used as coarse and fine aggregates, respectively. Based on the trip tickets, individual paste contents ranged from 24.7 to 26.1%, with an average of 25.3% and the actual quantities of IC water ranged from 7.7 to 8.2%, with an average of 8% by total weight of binder. The dosage of a mid-range water reducer admixture (MRWRA) and a set-retarding admixture were held constant throughout batching at 6 and 1.5 oz/cwt (3.9 and 1 mL/kg), respectively. No viscosity-modifying admixtures (VMA) were used.

The concrete properties and compressive strengths are listed in Table 2.30. Five tests for slump, air content, and temperature were performed. The slumps were measured only before pumping and ranged from 4 to 6 in. (100 to 150 mm), with an average of 4½ in. (115 mm). Only one test for slump (6 in. [150 mm]) showed a value higher than 5 in. (125 mm), the maximum limit in the specifications. While the second test was performed, the concrete had been pumped and placed on the deck; the second test showed a slump of 5¼ in. (130 mm). Except for one test, air contents were measured before pumping and ranged from 7.4 to 9.5%, with an average of 8.8%, within the specifications (6.5 to 10%). In the single test after pumping, the air content was 7.4%. After placing approximately 90 yd³ (69 m³) of the concrete, the pump became clogged. The concrete was stiff and the MnDOT personnel stated that water was not allowed to be added to the truck at the job site and, as a result, rejected the truck. The next truck had a slump of 4 ½ in. (115 mm) with an air content of 8.6% and was pumped with no issues. Concrete temperatures ranged from 74 to 78 °F (23 to 26 °C), with an average of 76 °F (24 °C) and 28-day compressive strengths ranged from 5780 to 7750 psi (39.9 to 53.4 MPa), all above the specified limit of 5500 psi (37.9 MPa).

Table 2.30: Concrete Test Results^a-MN-IC-LC-HPC-8

MN-IC-LC-HPC-8	Slump (in.)	Air content (%)	Concrete temperature (°F)	28-day compressive strength (psi)
Minimum	4	6.8	65	5780
Maximum	5¼ ^b	9.5	78	7750
Average	4½	7.9	71	6500

^a Values measured before pumping; cylinders were filled from truck discharge.

^b First test showed a 6-in slump, and another test was performed with a slump of 5¼ in.

Note: 1 in. = 25.4 mm; °C = (°F-32)×5/9; 1 psi = 6.89×10⁻³ MPa

The MN-IC-LC-HPC-8 was located approximately 25 minutes away from the ready-mix plant. Placement started on August 20, 2020, at 6:25 am, at the east end of the deck and continued to the west end. The placement was finished with the final strike-off on August 20, 2020, at 11:45 am. The concrete was placed using two pumps (the second pump was used after placing approximately 130 ft [40 m] of the deck), consolidated using a spud vibrator, and finished using a single-drum roller followed by a metal pan (as shown in Figure 2.29). The concrete was placed in strips about 5 ft (1.5 m) along the length of the deck. During placement, wind speeds at the deck ranged from 2.5 to 5.9 mph (4 to 9.5 km/hr). Relative humidity at the deck ranged between 60.1 and 74.5%. Ambient air temperature during construction ranged from 65 to 77 °F (18 to 25 °C). These environmental conditions resulted in relatively low evaporation rates, ranging from 0.05 to 0.07 lb/ft²/hr (0.24 to 0.34 kg/m²/hr), below the 0.2 lb/ft²/hr (1 kg/m²/hr) specifications limit. The time between batching and discharge ranged from 45 and 70 minutes, with an average of 58 minutes. The time between placement and strike-off ranged from 5 to 24 minutes, with an average of 12 minutes.



Figure 2.29: Finishing Equipment

During the placement, MnDOT personnel observed trapped air pockets appearing on the finished surface of the concrete, mainly near the east end abutment, as shown in Figure 2.30.

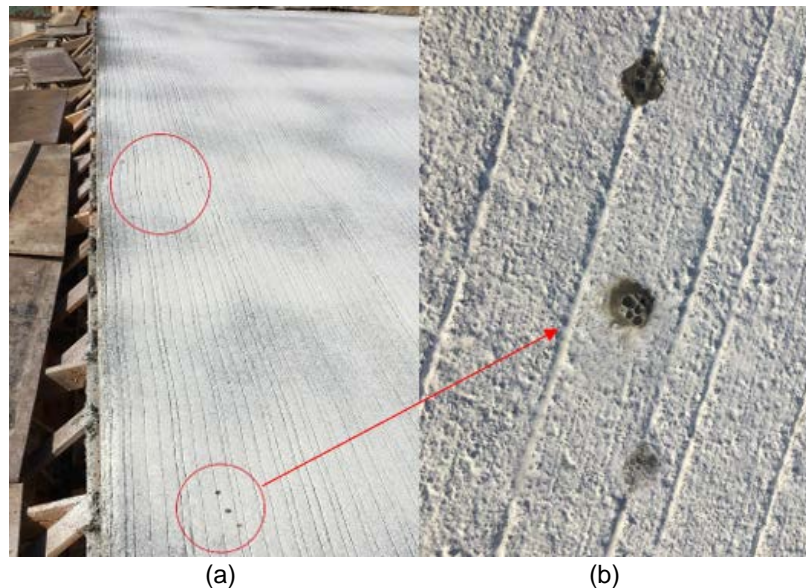

Figure 2.30: Trapped Air Pockets on Top of the East End Abutment (a) Overview; (b) Close-Up (Image Provided by MnDOT)

The vibrator was inserted at regularly spaced intervals, close enough to the last location so that the radius of action overlapped the last one. Two work bridges were used for bull floating, brooming, tining, the application of curing compound, and wet burlap. A highway straight edge was used in place of a bull float. Trowels were used for finishing the edges, concrete adjacent to the barrier reinforcement on each side, and near abutments. The deck was then tined before the application of the curing compound, as shown in Figure 2.31.

Shortly after tining, a single layer of curing compound was sprayed non-uniformly on the deck, as shown in Figure 2.32. As discussed in Section 3.3.1.10, one possible cause of the poor cracking performance of this deck could be this non-uniform distribution of curing compound, which can result in plastic shrinkage in regions with poor coverage. The time between strike-off and application of curing compound ranged from 13 to 28 minutes.



Figure 2.31: Tining the Deck Before Application of Curing Compound



Figure 2.32: Non-Uniform Distribution of Curing Compound on the Deck

The application of the curing compound began at the east end and continued to the west end of the deck. The concrete adjacent to the barrier reinforcement was covered with wet burlap, as shown in Figure 2.33, within an hour of consolidation.

KU researchers were informed that the deck would be covered by wet burlap when the concrete could be walked on without producing imprints deeper than $\frac{1}{16}$ in. (1.6 mm). The burlap rolls were soaked in water until they were transferred to the work bridge for placement. After the concrete had set, the application of wet burlap and plastic sheeting began from the east end and finished within an hour of curing compound application without additional delays, as illustrated in

Figure 2.34. Curing compound does not seal the surface, so tining, followed by a less than adequate application of a curing compound, is expected to result in increased cracking. Waiting until the concrete had set to apply burlap and plastic will provide less than adequate early curing.



Figure 2.33: Burlap Placement on the Barrier Reinforcement



Figure 2.34: Covering the Deck with Wet Burlap and Plastic Sheeting

2.4.11 MN-IC-LC-HPC-9

MN-IC-LC-HPC-9 carries eastbound traffic on I-90 over Dakota Valley in Winona. The deck was constructed in one placement on September 4, 2020. The concrete supplier and the contractor were the same as MN-IC-LC-HPC-8. The bridge has three spans with lengths of 44 ft-1 in. (13.4 m), 63 ft-10 in. (19.5 m), and 35 ft-2 in. (10.7 m), with a total length of 143 ft-1 in. (43.6 m). The deck has a 40 ft (12.2 m) wide roadway and a 1 ft-6 in. (0.46 m) wide barrier on each side, for a total deck width of 43 ft (13.1 m). The nominal deck thickness is 9 in. (229 mm); the deck is supported by prestressed concrete girders with a skew of 13° 45' 24".

As with MN-IC-LC-HPC-8, the LWA used in this project was an expanded clay stored in an open area at the ready-mix plant. The LWA was prewetted using a lawn sprinkler on top of the aggregate stockpile for at least a week prior to the construction date. The stockpile was approximately 7 ft (2.1 m) high, greater than the recommended 5-ft (1.5-m) limit. The sprinkler was turned off on the evening of September 3, 2020, letting the material drain approximately 12 hours prior to batching. Upon KU researchers' request, the LWA stockpile was turned several times before collecting a composite sample to measure the LWA absorption and free surface moisture prior to batching.

The average absorption (OD basis) and the specific gravity (OD basis) of the LWA obtained by KU researchers were 30.8% and 1.28, respectively, which differed slightly from the values used in MN-IC-LC-HPC-8 mixture proportions (31.1% and 1.27, respectively). The main difference between the mixture proportions of the two decks was the design quantity of internal curing water, which was 7% (by the weight of binder) based on KU researchers' recommendations for bridge decks cast late in the construction season to minimize durability problems (Lafikes et al., 2020). KU researchers revised the mixture proportions to get 7% of internal curing water by the weight of binder.

Although KU personnel recommended that the bottom 6 to 12 in. (150 to 300 mm) of the LWA stockpile not be used in batches, when the material was accumulated by the loader for placing into the aggregate bins, the bottom of the stockpile was completely disturbed as shown in Figure 2.35. It is common to observe a significant difference between the moisture content of the aggregates at the bottom and the top portions of the piles.



Figure 2.35: Disturbance of the Bottom of the Stockpile

A trial placement was not required due to successful construction of MN-IC-LC-HPC-8, which had similar mixture proportions and the same concrete supplier and contractor.

The initial, revised, and actual (based on the average of trip tickets) mixture proportions submitted to MnDOT are listed in Table 2.31. As with MN-IC-LC-HPC-8, MN-IC-LC-HPC-9 had a design w/cm ratio of 0.43 and a 30% replacement of cement (by total weight of binder) with Grade 100 slag cement, with a design paste content of 25.6%. The design quantity of internal curing water, however, was 7% (by the weight of binder).

Based on the trip tickets, similar to MN-IC-LC-HPC-8, on average 34 lb/yd³ (20 kg/m³) of water was initially withheld in the trucks, resulting in very stiff concrete with a w/cm ratio as low as 0.37. Therefore, the concrete supplier added a portion of the withheld water, ranging from 3 to 17 lb/yd³ (2 to 10 kg/m³), to the trucks at the ready-mix plant, increasing the w/cm ratio to 0.38. In contrast to MN-IC-LC-HPC-8, MnDOT inspectors verified that all trucks emptied their drums before getting a new load.

Crushed gravel and river sand were used as coarse and fine aggregates, respectively. Based on the trip tickets, the actual w/cm ratio was 0.38 and individual paste contents ranged from 23.8

to 24.7%, with an average of 24.0% and the actual quantities of IC water ranged from 6.8 to 7.3%, with an average of 7.0% by total weight of binder. The dosages of a mid-range water reducer admixture (MRWRA) and a set-retarding admixture were held constant throughout batching at 6 and 1.5 oz/cwt (3.9 and 1 mL/kg), respectively. No viscosity-modifying admixtures (VMA) were used.

Table 2.31: MN-IC-LC-HPC-9 Mixture Proportions (SSD/PSD Basis)

Material	Mixture proportions (lb/yd ³)		
	Initial	Revised	Actual ^a
Cement (Type I/II)	400	400	401
Grade 100 slag cement	170	170	170
Water	245	245	219
Fine lightweight aggregate	194	169	170
Coarse aggregate	1583	1583	1579
Fine aggregate	1099	1113	1108
Chemical Admixture (oz/cwt)			
BASF	Type	Initial	Actual ^a
Air AE 90	Air-Entraining	- ^b	0.85 to 0.99
Polyheed 1020	Water-Reducing	1-12	6
Set Delvo	Set Retarding	0-5	1.5
Matrix VMA 358	Viscosity-Modifying	0-10	Not used

^a Actual values based on average of trip tickets.

^b As needed.

Note: 1 lb/yd³ = 0.593 kg/m³, 1 oz/cwt = 0.652 mL/kg

The concrete properties and compressive strengths are listed in Table 2.32. Five tests for slump, air content, and temperature were performed. Except for one test, slump was measured before pumping and ranged from 3 to 4 in. (75 to 100 mm), with an average of 3¼ in. (80 mm). Only the first truck was rejected due to an out-of-specification slump. This truckload had an initial slump of 7 in. (175 mm), higher than 5 in. (125 mm), the maximum limit in the MnDOT specifications. A second test showed a slump of 6¾ in. (170 mm), resulting in the rejection of the truckload. In the single test performed after pumping the slump was 3½ in. (90 mm).

Except for two tests, air contents were measured before pumping and ranged from 6.2 to 9%, with an average of 7.9%, within the specifications (6.5 to 10%). The two air contents measured after pumping were 8.7 and 10.2%, respectively. Concrete temperatures ranged from 67 to 73 °F (19 to 23 °C), with an average of 72 °F (22 °C) and 28-day compressive strengths ranged from 5860 to 6880 psi (40.4 to 47.4 MPa), all above the specified limit of 5500 psi (37.9 MPa).

Table 2.32: Concrete Test Results^a-MN-IC-LC-HPC-9

MN-IC-LC-HPC-9	Slump^b (in.)	Air content (%)	Concrete temperature (°F)	28-day compressive strength (psi)
Minimum	3	6.2	67	5860
Maximum	4	9.0	73	6880
Average	4½	7.9	72	6320

^a Values measured before pumping; cylinders were filled from truck discharge.

^b One initial test showed a 7-in. slump, and another test was performed, eventually rejected.

Note: 1 in. = 25.4 mm; °C = (°F-32)×5/9; 1 psi = 6.89×10⁻³ MPa

The MN-IC-LC-HPC-9 was located approximately 30 minutes away from the ready-mix plant. Placement started on September 4, 2020, at 6:50 am, at the east end of the deck and continued to the west end. Placement finished with the final strike-off on August 20, 2020, at 10:35 am. As with the construction of MN-IC-LC-HPC-8, the concrete was placed using one pump, consolidated using a spud vibrator, and finished using a single-drum roller screed followed by a metal pan. The concrete was placed in strips about 5 ft (1.5 m) along the length of the deck. The MN-IC-LC-HPC-9 placement is shown in Figure 2.36.



Figure 2.36: MN-IC-LC-HPC-9 Placement

During placement, wind speeds at the deck ranged from 0 to 2 mph (0 to 3.2 km/hr). Relative humidity at the deck ranged between 43.3 and 70.3%. Ambient air temperature during construction ranged from 66 to 74 °F (19 to 23 °C). These environmental conditions resulted in relatively low evaporation rates, ranging from 0.03 to 0.05 lb/ft²/hr (0.14 to 0.24 kg/m²/hr), below the 0.2 lb/ft²/hr (1 kg/m²/hr) specifications limit. The time between batching and discharge ranged from 46 to 83 minutes, with an average of 59 minutes. There were transmission problems with the third truck, causing a delay during placement; the 83-minute delay between batching and discharging was due to this delay. The time between placement and strike-off ranged from 5 to 20 minutes, with an average of 11 minutes. The vibrator was inserted at regularly spaced intervals, close enough to the last location so that the radius of action overlapped the last one. Two work bridges were used for bull floating, brooming, and tining the application of curing compound and wet burlap. A highway straight edge was used in place of a bull float. Trowels were used for finishing the edges, concrete adjacent to the barrier reinforcement on each side, and near abutments. The deck was then tined followed by a single layer of curing compound sprayed on the deck. As discussed in Section 3.3.1.11, a notable amount of map cracking was observed on the deck surface, especially in the middle of spans 1 and 3, at an age of 20.6 months. The majority of cracks were longitudinal (lengths of 2 ft [0.6 m] or less) distributed over the entire deck area. As will be discussed in Section 3.3.1.11, a possible reason for the poor cracking performance of this

deck could be the non-uniform distribution of curing compound applied during construction, as shown in Figure 2.37, which can result in plastic shrinkage. The time between strike-off and application of curing compound ranged from 5 to 35 minutes.



Figure 2.37: Non-Uniform Application of the Curing Compound on the Deck

The application of the curing compound began at the east end and continued to the west end of the deck. The concrete adjacent to the barrier reinforcement was covered with wet burlap during construction within an hour of each section being consolidated, as shown in Figure 2.38.



Figure 2.38: Burlap Placement on the Barrier Reinforcement

During the placement, MnDOT personnel observed trapped air pockets appearing on the finished surface of the concrete, mainly near the east end abutment, as shown in Figure 2.39.

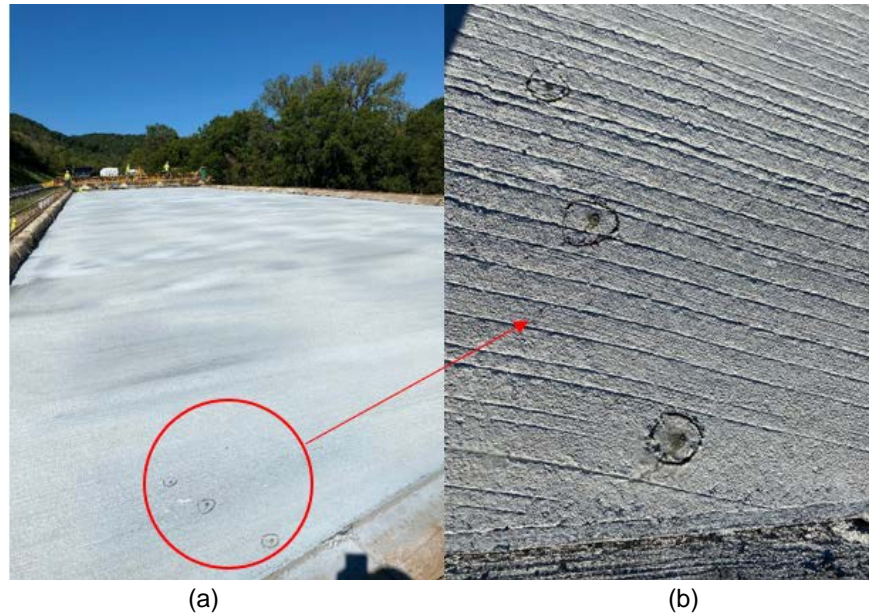

Figure 2.39: Trapped Air Pockets on the Deck (a) Overview; (b) Close-Up

As with MN-IC-LC-HPC-8, KU researchers were informed that the deck would be covered by wet burlap when the concrete could be walked on without producing imprints deeper than $\frac{1}{16}$ in. (1.6 mm). The burlap rolls were soaked in water until they were transferred to the work bridge prior to placement. The application of wet burlap, as illustrated in Figure 2.40, and plastic sheeting began from the east end and finished within an hour of application of curing compound without any considerable delays. It was observed, however, that the personnel stepped on the deck while placing wet burlap.



Figure 2.40: Wet Curing Application on MN-IC-LC-HPC-9

2.4.12 Failed MN-IC-LC-HPC Bridge Deck Placement in 2016

In 2016, MN-IC-LC-HPC deck (Br. 58821) was bid under the MnDOT IC-LC-HPC specifications but was not constructed following those specifications. The lessons learned from the failed placement are summarized in this section. Br. 58821 is a two-lane bridge deck that carries southbound traffic on I-35 over Corix Valley Railroad near Hinckley. The deck was constructed in one placement on October 6, 2016. The concrete supplier and the contractor were Cemstone Products Co. and Redstone Construction, respectively. The bridge has three spans with lengths of 68 ft-3 in. (20.8 m), 83 ft-6 in. (25.5 m), and 68 ft-3 in. (20.8 m), with a total length of 220 ft-1 in. (67.1 m). The deck has a 42 ft (12.8 m) wide roadway and a 1 ft-8 in. (0.51 m) wide barrier on each side, for a total deck width of 45 ft-4 in. (13.8 m). The nominal deck thickness is 9 in. (229 mm); the deck is supported by prestressed concrete girders with a skew of $-49^{\circ} 29' 30''$.

The main factors contributing to this failed placement consist of

1. failure to measure LWA properties within the hour prior to batching,
2. failure to add all required admixtures at the time of batching, and
3. failure to place concrete with the same equipment that was used in the trial placement.

A new shipment of prewetted LWA materials was delivered to the ready-mix plant on October 5, 2016. Upon KU researchers' request, the LWA stockpile was turned several times

before collecting a composite sample to measure the LWA absorption and free surface moisture. The average absorption (OD basis) and the free-surface moisture (OD basis) of the LWA obtained by KU researchers were 26 and 7.5% (measured approximately 15 hours before deck placement), respectively, which slightly differed from the values (25.6 and 8.4%, respectively) determined by the concrete supplier personnel. Concrete supplier personnel did not conduct any additional tests for free-surface moisture after loading the LWA into the aggregate hopper, even though the materials were allowed to drain for approximately 15 hours before deck placement. On the day of batching, KU researchers measured a free-surface moisture of 4.3%, while the concrete supplier personnel used the initial obtained free-surface moisture (8.4%). This deviation decreased the mixing water and the w/cm by 6 lb/yd³ (3.5 kg/m³) and 0.01, respectively.

The concrete supplier was responsible for producing concrete for the deck and the approach slabs, with and without IC, respectively. While the east approach slab was being constructed, the first truckload containing IC had to wait for approximately 40 minutes at the plant before departing for the job site. As a result, the concrete supplier produced four more IC truckloads and sent them to the job site to accelerate the construction. After pumping, the first truckload had a 1¾ in. (45 mm) slump. Based on the trip tickets, 8 lb/yd³ (5 kg/m³) of water were being withheld during batching. Therefore, trim water was added back at the jobsite to improve pumpability and workability. This load was rejected due to the long delay between the time of batching and discharging. It was also noticed that the concrete supplier had not added VMA to the truckloads at the time of batching. A dosage of either 3 or 6 oz/cwt (1.9 or 3.9 mL/kg) of VMA was added to the four other truckloads at the job site. In spite of these changes, the concrete remained out-of-specification for air content and slump, resulting in the rejection of the truckloads. Due to insufficient LWA at the ready-mix plant, with the approval of MnDOT personnel, the placement was resumed using standard MnDOT HPC mixture proportions without IC.

During the construction, it was revealed that a larger pump was used for deck placement than was used for the trial placement. Larger pumps (longer lines) operate at lower pressures than smaller pumps, resulting from greater friction and higher head losses. This reinforces the importance of using the same equipment for the trial placement and the deck (Lindquist et al., 2008; McLeod et al., 2009).

2.5 KDOT IC-LC-HPC Specifications

As described in Chapter 1, Low-Cracking High-Performance (LC-HPC) specifications have been modified over the years based on lessons learned in the laboratory and in the field. While KDOT and the University of Kansas (KU) were working together on finalizing the specifications, one IC deck had been let in 2019 with an earlier version of the specifications. The earlier and the most recent specifications included the use of internal curing with or without incorporating supplementary cementitious materials (SCMs) as partial replacement of portland cement in an effort to reduce further cracking. The major differences between the two versions are discussed in the following sections.

The IC decks constructed in Kansas followed the requirements of the most recent LC-HPC specifications (see Appendix C): 1102 “Aggregate,” 401 “General Concrete,” Sections 1102.2f.(2) and 401.3g, respectively, for designing internally cured concrete mixtures that reduce cracking by incorporating prewetted fine lightweight aggregate, 402 “Structural Concrete,” and 710 “Construction.” As described in Chapter 1, the specifications provide materials, concrete properties, and construction requirements. Since all the LC-HPC decks constructed between 2019 and 2022 included internal curing, they are referred to as KDOT IC-LC-HPC decks in this study. The most recent KDOT IC-LC-HPC specifications are provided in Appendix C. Although most of the MnDOT and KDOT specifications requirements are similar, there are some differences.

2.5.1 Aggregates

The special provisions cover the requirement for fine lightweight aggregate. In contrast with MnDOT IC-LC-HPC specifications, KDOT IC-LC-HPC specifications do not impose a maximum on the volume replacement of total aggregate with prewetted LWA. The specifications indicate that a portion of normal weight fine aggregate must be replaced with prewetted LWA to provide 7% IC water by the weight of binder for IC-LC-HPC decks. As with MnDOT specifications, KDOT specifications place a maximum size aggregate of $\frac{3}{8}$ in. (9.5 mm) on LWA. The LWA is required to be prewetted using sprinklers for at least 72 hours or until an acceptable absorption is achieved prior to batching. The specifications indicate that the sprinklers must be turned off to allow the materials to drain 24 hours prior to batching. The LWA stockpile height is

limited to 5 ft (1.5 m) and is required to be turned daily to provide a uniform moisture content, especially before taking samples and batching. The specifications also enforce requirements pertaining to handling and stockpiling LWA, including protection from contamination, segregation, and non-uniform grading and moisture distribution.

The prewetted LWA absorption and specific gravity must be measured 24 hours prior to batching. The free-surface moisture of the LWA must also be measured within an hour prior to batching. The specifications require the use of a centrifuge to obtain the prewetted surface-dry (PSD) LWA. The mixture proportions are required to be revised based on the LWA properties obtained 24 hours prior to batching to ensure the design quantity of IC water (7% by the weight of binder) is provided.

The specifications also include the requirements for the normal weight coarse and fine aggregates. The coarse aggregate must be gravel, chat, or crushed stone, with a minimum soundness (KTMR-21) of 0.9 and no upper limit for absorption. The specifications allow the use of either natural sand or chat as fine aggregate, complying with requirements specified in Section 1102.2e (see Appendix C). Limestone (with nominal absorption ranging from 1 to 2%) and natural sand were used as the coarse and fine aggregates for the construction of IC-LC-HPC decks in Kansas, respectively. The provisions also require that a composite gradation of the aggregates comply with requirements specified in accordance with Table 1102-3, Section 1102.2b using a proven optimization method, such as the Shilstone Method or the KU Mix Method (Lindquist et al. 2008, 2015) (Appendix C). A maximum size aggregate of 1 in. (25 mm) is required in accordance with the specifications.

2.5.2 Concrete

Table 2.33 summarizes the requirements for structural concrete in the KDOT IC-LC-HPC specifications. The specifications limit the cementitious material content to 500 to 560 lb/yd³ (297 to 332 kg/m³), with a slightly higher maximum limit compared to the earlier specifications (550 lb/yd³ [326 kg/m³]), with a water-to-cementitious material (*w/cm*) ratio between 0.43 and 0.45. The specifications also limit mass replacement of portland cement with each supplementary cementitious material. In the 2019 IC deck, the specifications allowed slag cement and silica fume

with maximum replacement of 30 and 3%, respectively, by weight of binder. For subsequent decks, the maximum replacement level for silica fume was 2%. Although paste content can vary based on the types, replacement levels of cementitious materials, and *w/cm* ratios, it is limited to 26% by concrete volume. The allowable air content for the 2019 IC deck ranged from 5 to 8%, while this range changed to 6.5 to 9.5% for subsequent decks. The maximum allowable slump is 4 in. (100 mm) ± 1 in. (25 mm). To reduce the chance of thermal and plastic shrinkage cracking, the temperature of the fresh concrete is required between 50 and 80 °F (10 and 27 °C).

In contrast with MnDOT IC-LC-HPC specifications, KDOT IC-LC-HPC specifications allow the concrete suppliers to withhold a maximum of 17 lb/yd³ (10 kg/m³) of mixing water at the batch plant and, if required, add it back at the job site. The specifications also allow the addition of set retarding admixtures as with MnDOT IC-LC-HPC specifications.

Table 2.33: Requirements for Concrete in KDOT IC-LC-HPC Decks

Construction year	Cementitious materials contents (lb/yd ³)	<i>w/cm</i> ratio	Maximum SCM (fly ash/slag cement/silica fume [%])	Air content (%)	Maximum slump (in.) ^a
2019	500-550	0.43-0.45	0/30/3	5-8	4
2020	500-560		0/30/2	6.5-9.5	
2021					
2022					

^a The tolerance is ±25% of the designated slump.

Note: 1 in. = 25.4 mm; °C = (°F-32)×5/9; 1 psi = 6.89×10⁻³ MPa

The specifications also include requirements for 28-day compressive strength, rapid chloride permeability, freeze-thaw durability, and drying shrinkage for hardened concrete.

In contrast with the MnDOT IC-LC-HPC specifications, the KDOT specifications limit only the minimum of 28-day compressive strengths to 3500 psi (24.1 MPa). Based on the work of Khajehdehi and Darwin (2018), higher strength concrete is no longer thought to be an issue in bridge deck cracking.

The specification requirements for this study included: ion conductivity and resistivity of hardened concrete include the maximum charge passed to be less than 1500 coulombs at 56 days in accordance with ASTM C1202 and a minimum of 19 kΩ-cm surface resistivity measurements

at 56 days in accordance with KT-79, Surface Resistivity Indication of Concrete's Ability to Resist Chloride Ion Penetration. It also specifies aggregate requirements for the freeze-thaw resistance of the concrete in accordance with KTMR-22, Resistance of Concrete to Rapid Freezing and Thawing, that includes the use of ASTM C666-Procedure B, with a failure limit of 95% of the initial dynamic modulus of elasticity at 660 cycles. Drying shrinkage at 365 days is limited to 700 microstrain.

2.5.3 Construction

A qualification batch containing at least 6 yd³ (4.5 m³) is required at least 60 days before the actual deck placement. The qualification batch is required to be successfully placed on a qualification slab to demonstrate that the concrete supplier and the contractor can properly produce, pump, and place IC-LC-HPC. Contractors are required to employ the same supplier, batch plant, materials, equipment, and methods used on both the qualification slab and the bridge deck.

As with the MnDOT specifications, the KDOT specifications specify a maximum evaporation rate of 0.2 lb/ft²/hr (1.0 kg/m²/hr). When required, the specifications require the use of protective measures, such as cooling the concrete by replacing some of the mixing water with ice, providing early application of wet curing, and using windbreaks to protect the concrete from direct wind to reduce the potential for plastic shrinkage cracking. Fogging is allowable only if it does not cause water to drip, flow, or puddle on the deck during the construction. According to the specifications, the use of finishing aids or the addition of water to the concrete surface is prohibited.

A mechanical device with concrete vibrators of the same type and size is required to uniformly consolidate IC-LC-HPC decks. Vibrators should be extracted smoothly from the plastic concrete to prevent voids or holes from appearing on the deck. To remove any voids left by workers on the deck, the vibrator must be reinserted within one-half of its action radius to fully reconsolidate the concrete. Dragging the vibrators horizontally and walking through freshly consolidated concrete are prohibited. Hand-held vibrators should be used to consolidate areas that the mechanical device cannot reach. Vibrators must be inserted for 3 to 15 seconds, and the insertions must be made in small steps less than 12 in. (25 mm) apart.

KDOT IC-LC-HPC decks must be struck off with a self-propelled finishing machine or a drum roller screed and finished by one or more metal pans, a burlap drag, or both, followed by bull floating if required (to remove local irregularities).

The KDOT specifications indicate covering the entire deck with a first layer of pre-soaked burlap (soaked for at least 12 hours) with no visible openings on the deck within 15 minutes after the final strike-off, followed by a second layer within 10 minutes. The concrete surface must remain continuously wet for at least 14 calendar days. In contrast with MnDOT specifications, the use of curing compound is prohibited during the 14-day wet curing period on the deck.

2.6 Deck Construction-Kansas

Table 2.34 summarizes the information on bridge decks included in this section. The KDOT IC-LC-HPC decks were constructed between 2019 and 2021. KS-IC-LC-HPC decks are numbered in the order they were constructed. In the cases where the bridge decks were constructed in multiple placements, the placement number (P#) is added at the end of the bridge ID. The decks are located in Edgerton and Ottawa. KS-IC-LC-HPC-1 is supported by prestressed concrete girders, while the other two decks are supported by steel girders. All the decks carry vehicular traffic and have no sidewalks.

The placements were constructed in September or November. Except for KS-IC-LC-HPC-2, the decks were placed in one placement. Table 2.35 lists the bridge dimensions, concrete suppliers, and construction contractors for the Kansas decks in this study.

Table 2.34: KDOT IC-LC-HPC Deck Information

Bridge ID	Bridge No.	Location	Structure type	Subdeck placement date
KS-IC-LC-HPC-1	35-46 KA 3083-01	Sunflower Rd. over I-35, Edgerton	Prestressed concrete girders	11/26/2019
KS-IC-LC-HPC-2-P1^a	35-30 KA- 3102-01	Montana Rd over I-35, Ottawa	Steel Girders	11/3/2020
KS-IC-LC-HPC-2-P2				11/11/2020
KS-IC-LC-HPC-3	35-46 KA 3929-01	199 th St. over I-35, Edgerton	Steel Girders	9/16/2021

^a P# stands for placement.

Table 2.35: KDOT IC-LC-HPC Deck Geometry, Project Supplier, and Contractors

Bridge ID	Skew (deg.)	No. of spans	Length (ft)	Width (ft)	Concrete supplier	Contractor
KS-IC-LC-HPC-1	18° 32' 0"	2	237	60.8	Fordyce	Pyramid
KS-IC-LC-HPC-2-P1 ^a	25°	4	338	21.3	Builders Choice Concrete	A.M. Cohron & Son
KS-IC-LC-HPC-2-P2				21.3		
KS-IC-LC-HPC-3	-55° 8' 20"	4	610	43	Fordyce	Pyramid

^a P# stands for placement.

The IC deck placements have between two and four spans, with skews between -55° 8' 20" and 25°. The lengths of the bridges range from 237 to 610 ft (72.2 to 185.9 m), and the widths range from 42.5 to 60.8 ft (12.9 to 18.5 m).

2.6.1 Concrete Mixture Proportions

The cementitious material percentages and aggregate proportions for each bridge deck are given in Table 2.36. The mixture proportions for KDOT IC-LC-HPC decks contained either a binary composition system including 30% cement replacement with slag cement by weight of binder or a ternary composition system including 30% cement replacement with slag cement and either 2 or 3% replacement with silica fume by weight of binder.

Table 2.36: Cementitious Material Percentages and Aggregate Proportions (SSD/PSD Basis)^a

Bridge ID	Cementitious material percentages ^c (lb/yd ³)	Coarse Agg. (lb/yd ³)		Fine Agg. (lb/yd ³)		LWA Agg. (lb/yd ³)	
		Design	Actual	Design	Actual	Design	Actual
KS-IC-LC-HPC-1 ^b	67% C, 30% S, 3% SF	1193	1189	1103	1101	306	304
		286	290				
KS-IC-LC-HPC-2-P1	70% C, 30% S	1683	1681	841	841	280	279
KS-IC-LC-HPC-2-P2			1680	841	840	280	279
KS-IC-LC-HPC-3 ^b	68% C, 30% S, 2% SF	1299	1304	1098	1097	161	162
		272	278				

^a Actual values are based on the average of trip tickets.

^b KS-IC-LC-HPC-1, and-3 used two size fractions for coarse aggregate (¾ and ½ in., first and second row, respectively).

^c Percentages by total weight of cementitious material; C = portland cement; S = Grade 100 slag cement; SF = Silica Fume.

Note: 1 in. = 25.4 mm, 1 lb/yd³ = 0.593 kg/m³.

Table 2.37 shows the LWA properties obtained by KU/KDOT personnel, as well as the values used in design, as given by the concrete suppliers.

Table 2.37: Average LWA Properties, Design and Actual Values Obtained by KU Researchers

Bridge ID	Absorption (% OD basis)		Specific gravity (OD basis)	
	Design	KU/KDOT measurements	Design	KU measurements
KS-IC-LC-HPC-1	14.3	13.7	1.44	1.54
KS-IC-LC-HPC-2-P1	14.1	15.5	1.31	1.61
KS-IC-LC-HPC-2-P2		15		1.51
KS-IC-LC-HPC-3	30	43	1.31	1.26

Table 2.38 shows the design and actual values of the total weight of cementitious materials, water contents, water-to-cementitious materials (w/cm) ratio, paste contents, and IC water contents for each deck. The actual values are based on the average of values from trip tickets. KS-IC-LC-HPC-2 had a design w/cm ratio of 0.43, the lowest in this study. The design w/cm ratios for the IC-LC-HPC decks were either 0.43 or 0.45, with actual average w/cm ratios ranging from 0.42 to 0.44. The design paste contents for the IC-LC-HPC decks ranged from 24.2 to 24.6%, with actual paste contents ranging from 23.8 to 24.2%. The design IC water content for the IC-LC-HPC decks was 7%, with actual values ranging from 6.7 to 8.5%. The quantity of IC water is based on the amount of absorbed water in and the quantity of LWA in the mixture proportions. The variation in LWA absorption observed in this study resulted in a significant difference between the design value and the actual quantity of IC water for some decks, as illustrated in Table 2.38. This can also result in incorrect amounts of mixing water being batched or withheld during batching, affecting actual w/cm ratios and paste contents if the LWA absorption and free-surface moisture are not measured within 24 and one hour, respectively, prior to batching. Data from individual trip tickets are provided by Bahadori et al. (2023).

Table 2.38: Cementitious Material Content, Water Content, w/cm Ratio, Paste, and IC Water Contents for KDOT IC-LC-HPC Decks^a

Bridge ID	Cementitious material content (lb/yd ³) ^b		Water content (lb/yd ³)		w/cm ratio		Paste content (%)		IC water (% of binder weight)	
	Design	Actual	Design	Actual	Design	Actual	Design	Actual	Design	Actual
KS-IC-LC-HPC-1	530	530	238	233	0.45	0.44	24.6	24.2	7	6.7
KS-IC-LC-HPC-2-P1	540	540	232	225	0.43	0.42	24.2	23.8	7	6.9
KS-IC-LC-HPC-2-P2		540		230		0.43		24.1		6.7
KS-IC-LC-HPC-3	530	529	238	231	0.45	0.44	24.4	24.0	7	8.5

^a Actual values are based on the average of trip tickets.

^b See Table 2.36 for details.

Note: 1 lb/yd³ = 0.593 kg/m³

2.7 Bridge Decks

Table 2.39 summarizes the concrete properties, including the average slump, air content, concrete temperature, and 28-day compressive strength for the KDOT IC decks included in this study. The projects are discussed in greater detail in Sections 2.7.1 through 2.7.3. The average slumps ranged from 4¾ to 5¾ in. (120 to 145 mm). Air contents were all within the corresponding specification limits, ranging from 6.3 to 8.6%. Concrete temperatures were also within the specification limits (50 to 80 °F [10 to 27 °C]), ranging from 64 to 76 °F (18 to 24 °C). The average 28-day compressive strengths of the decks ranged from 3570 to 7070 psi (24.6 to 48.7 MPa).

Table 2.39: Average KDOT IC-LC-HPC Concrete Properties

Bridge ID	Slump (in.)	Air content (%)	Concrete temperature (°F)	28-day compressive strength
KS-IC-LC-HPC-1	5	6.3	69	5660
KS-IC-LC-HPC-2-P1 ^a	5¾	8.6	64	7070
KS-IC-LC-HPC-2-P2	4¾	8.3	71	6850 ^a
KS-IC-LC-HPC-3	5¾	7	76	3570

^a Values measured before pumping.

Note: 1 in. = 25.4 mm; °C = (°F-32)×5/9; 1 psi = 6.89×10⁻³ MPa

2.7.1 KS-IC-LC-HPC-1

KS-IC-LC-HPC-1 is a two-lane bridge that carries traffic on Sunflower Rd. over I-35 in Edgerton, Kansas. The deck was constructed in one placement on November 26, 2019. The concrete supplier and the contractor were Fordyce and Pyramid Contractors, respectively. The

bridge has two equal spans of length 118 ft-6 in. (36.1 m), for a total length of 237 ft (72.2 m). The deck has a 58 ft (17.7 m) wide roadway and a 1 ft-4½ in. (0.41 m) wide barrier on each side, for a total deck width of 60 ft-9 in. (18.5 m). The nominal deck thickness is 8½ in. (216 mm) with 9½-in. (241-mm) thick overhangs; the deck is supported by prestressed concrete girders with a skew of 18° 32' 0".

The lightweight aggregate (LWA) was shipped to the batch plant four days prior to the placement date. The LWA used in KS-IC-LC-HPC-1 was an expanded shale stored in an open area at the batch plant. The LWA was prewetted using an oscillating sprinkler on top of a retaining wall near the aggregate stockpile (shown in Figure 2.41). The stockpile was approximately 7 ft (2.1 m) high, greater than the recommended 5-ft (1.5-m) limit. The sprinkler was turned off on the evening of November 25, 2020, letting the material drain for approximately 15 hours prior to batching. Upon KU researchers' request, the LWA stockpile was turned several times before collecting a composite sample to measure the LWA absorption and free surface moisture prior to batching.



Figure 2.41: KS-IC-LC-HPC-1 Lightweight Aggregate Stockpile

The average absorption and specific gravity (both OD basis) of the LWA obtained by KU researchers were 13.7% and 1.75, respectively, which differed from the values indicated in the

original mixture proportions (14.3% and 1.65, respectively), which were used to determine the batch weights. Having a lower absorption than the design value resulted in a lower internal curing water content (6.7% by the weight of binder) than the design value (7% by the weight of binder).

A qualification slab was successfully placed on October 22, 2019, with KU and KDOT personnel in attendance to verify the concrete workability, pumpability, and finishability. The LWA was shipped to the batch plant a day before the qualification placement, and it was stored in an open area at the batch plant. The LWA exhibited variable absorption values prior to wetting. The LWA was prewetted using an oscillating sprinkler for approximately 9 hours and allowed to drain for only two hours before batching. A single truck (with a capacity of 9.5 yd³ [7.2 m³]) was batched. The qualification slab was a garage ramp with dimensions of 7 ft-10 in. (2.4 m) by 20 ft-10 in. (6.3 m) with a variable depth between 7 in. (178 mm) and 13 in. (307 mm).

The mixture proportions included a ternary binder composition (a 30% replacement by weight of portland cement with slag cement and a 3% replacement by weight of portland cement with silica fume). The design paste content and the water-to-cementitious material (*w/cm*) ratio were 24.6% (by concrete volume) and 0.45, respectively. The design quantity of internal curing water was 7% (by the weight of binder). One test was performed for slump and air content after pumping at the job site. The concrete slump (4¾ in. [120 mm]) was within KDOT specifications (5 in. [125 mm]), but the air content (4.9%) was below the specified values (5 to 8%). The qualification slab was placed using a pump, consolidated using a single hand-held vibrator, and finished with a bull float. The application of curing was not observed by KU personnel. During the placement, no issues were observed, and KDOT approved the qualification slab.

The initial and actual (based on average of trip tickets) mixture proportions are listed in Table 2.40. KS-IC-LC-HPC-1 had a design *w/cm* ratio of 0.45 and a 30% replacement of cement (by total weight of binder) with Grade 100 slag cement and a 3% replacement of cement (by total weight of binder) with silica fume, with a design paste content of 24.6%. The design quantity of internal curing water was 7% (by the weight of binder). Limestone (with two maximum aggregate sizes of ½ and ¾ in. [12.5 and 19 mm]) and river sand were used as coarse and fine aggregates, respectively.

Based on the trip tickets, 4 lb/yd³ (2 kg/m³) of water was held from all the truckloads, except for the first three trucks, that had 8 lb/yd³ (5 kg/m³) withheld, reducing the actual *w/cm* ratio to an average of 0.44 for the full deck. Prior to casting, KU personnel measured a free-surface moisture of 2.6%, while a free-surface moisture of either 3.5 or 4% was determined and used by the batch plant personnel. This deviation decreased the mixing water and the *w/cm* by 3.5 lb/yd³ and 0.006, respectively. Based on the trip tickets, individual paste contents ranged from 23.9 to 24.4%, with an average of 24.2% and the actual quantities of IC water ranged from 6.6 to 6.9%, with an average of 6.7% by total weight of binder. A superplasticizer was added to the trucks at dosage rates between 4 and 5 oz/cwt (2.6 and 3.3 mL/kg) to achieve the desired slump. A set-retarding admixture was added to the trucks at a constant dosage of 1.5 oz/cwt (1 mL/kg).

Table 2.40: KS-IC-LC-HPC-1 Mixture Proportions (SSD/PSD Basis)

Material		Mixture proportions (lb/yd ³)	
		Initial	Actual ^a
Cement (Type I/II)		355	355
Grade 100 slag cement		159	159
Silica Fume		16	16
Water		238	233
Fine lightweight aggregate		306	304
¾ in. Coarse aggregate		1193	1189
½ in. Coarse aggregate		286	290
Fine aggregate		1103	1101
Chemical Admixture (oz/cwt)			
Euclid	Type	Initial	Actual ^a
Eucon AEA 92S	Air-Entraining	0.5-2	0.45-0.6
Plastol 6420	Water-Reducing	2-10	4-5
Eucon Retarder 100	Set-Retarding	2-6	1.5

^a Actual values based on average of trip tickets.

Note: 1 lb/yd³ = 0.593 kg/m³, 1 oz/cwt = 0.652 mL/kg

The concrete properties and compressive strengths are listed in Table 2.41. Four tests for slump, air content, and temperature were performed during construction, before pumping, and 10 tests were performed after pumping. Before pumping, the slumps ranged from 4 to 6 in. (100 to 175 mm), with an average of 4¾ in. (120 mm), and the air contents ranged from 6.3 to 6.8%, with

an average of 6.6%. After pumping, the slumps ranged from 4 to 7 in. (100 to 175 mm), with an average of 5 in. (125 mm), the air contents ranged from 5.5 to 7.6%, with an average of 6.3%, all within the deck specification limits (5 to 8%), and the concrete temperatures ranged from 66 to 70 °F (19 to 21 °C), with an average of 69 °F (20 °C), and the 28-day compressive strengths ranged from 5020 to 6180 psi (34.6 to 42.5 MPa), after pumping. The 28-day compressive strength for a single test performed before pumping was 6180 psi (42.6 MPa).

Table 2.41: Concrete Test Results-KS-IC-LC-HPC-1

KS-IC-LC-HPC-1	Slump (in.)	Air content (%)	Concrete temperature (°F)	28-day compressive strength (psi)
Minimum	4	5.5	66	5020
Maximum	7	7.6	70	6170
Average	5	6.3	69	5660

Note: 1 in. = 25.4 mm; °C = (°F-32)×5/9; 1 psi = 6.89×10⁻³ MPa

The KS-IC-LC-HPC-1 bridge deck was located approximately 20 minutes away from the batch plant. Placement started on November 26, 2019, at 6:30 am at the north end of the deck and continued to the south end, finishing with the final strike-off at 3:30 pm. The concrete was placed using two pumps (one at the north end and the other near the south end), consolidated using a manually operated gang vibration system, including four hand vibrators mounted on a moveable frame followed by a spud vibrator near the edges of the deck, and finished using a double-drum roller screed followed by two metal pans and a burlap drag system mounted on a work bridge. Figures 2.42 and 2.43 show the placement equipment used for the construction. The concrete was placed in strips about 5 ft (1.5 m) wide along the length of the deck.



(a) (b)
Figure 2.42: Placement Equipment (a) Manually Operated Gang Vibration System; (b) Double-Drum Roller Screed Followed by Two Metal Pans

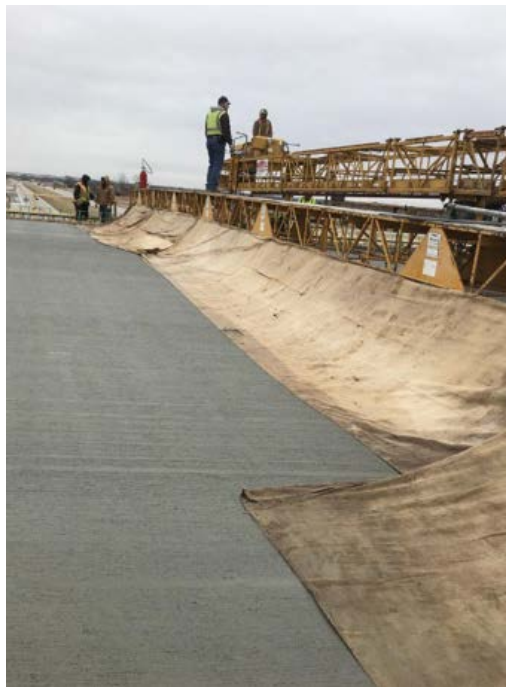

Figure 2.43: Burlap Drag System

During placement, wind speeds at the deck ranged from 0.4 to 10 mph (1 to 16 km/hr). Relative humidity at the deck ranged between 58.0 and 78.5%. Ambient air temperature during

construction ranged from 38 to 49 °F (3 to 9 °C). These environmental conditions resulted in evaporation rates, ranging from 0.04 to 0.16 lb/ft²/hr (0.19 to 0.78 kg/m²/hr), below the 0.2 lb/ft²/hr (1 kg/m²/hr) specification limit. To help reduce the evaporation rate near the surface, the contractor occasionally turned on a fogging system mounted on the backside of the finishing equipment. On one occasion, one of the pipes in the fogging system caused water droplets to accumulate on the surface, as shown in Figure 2.44. Contractor personnel were notified, and the issue was resolved.



Figure 2.44: Ponded Water on the Surface of the Bridge Deck

Delays in finishing occurred on three occasions. The northern pump became clogged after placing approximately 150 yd³ (114.6 m³) of concrete. The problem was resolved quickly after repairing the pump. A 35-minute delay occurred about halfway through placement (after placing 408 yd³ [311.9 m³]) due to equipment problems at the batch plant. During this delay, the double-roller screed passed several times over previously finished concrete. KU researchers notified the contractor, and the finishing equipment was turned off. Another delay occurred when changing the pumps (after placing 437 yd³ [334.1 m³] of concrete), leaving the concrete exposed to the environment for approximately 10 minutes. Crack surveys at an age of 30.9 months, discussed in Section 3.3.2.1, indicated the presence of cracks, near these locations, on either side of the piers.

The contractor accommodated all requests made by KU researchers regarding consolidation and finishing. Initially, the vibrators were quickly extracted from the concrete,

leaving a series of holes on the surface and were not lifted high enough, causing the vibrators to drag across the surface. At the request of KU researchers, the contractor raised the vibrators and slowed down extraction of the vibrators. It should be noted, however, that the vibrators were lowered and lifted manually by two construction workers, and occasionally holes were left in the concrete, as shown in Figure 2.45.

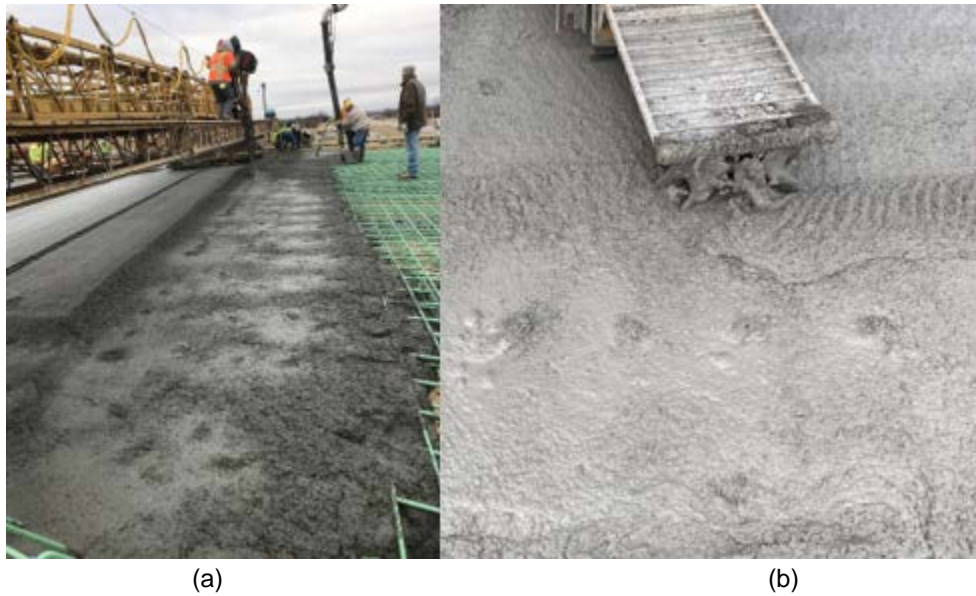

Figure 2.45: Holes Left on the Surface of the Bridge Deck. (a) Overview; (b) Close-Up View

Occasionally, construction personnel were observed stepping in areas that had been recently vibrated, to shovel the concrete, causing deconsolidation of the concrete, as shown in Figure 2.46. Crack surveys at an age of 30.9 months, discussed in Section 3.3.2.1, however, did not indicate any cracks in these regions.



Figure 2.46: Walking Through Consolidated Concrete

The time between batching and discharge ranged from 25 to 54 minutes, with an average of 40 minutes. The time between placement and strike-off ranged from 8 to 33 minutes, with an average of 16 minutes. Bull floats were used in the transverse direction on the deck; near the barriers, the concrete was tined with a broom, as shown in Figure 2.47. Shortly after the bull floating, wet burlap was placed on the bridge deck. The burlap rolls were soaked in water for at least 24 hours. Figure 2.48 shows the deck covered with wet burlap.



(a)

(b)

Figure 2.47: Bull Floating and Brooming (a) Bull Floating the Deck; (b) Brooming



Figure 2.48: Burlap Placement on the Deck

2.7.2 *KS-IC-LC-HPC-2*

KS-IC-LC-HPC-2 is a two-lane bridge that carries traffic on Montana Road over I-35 in Ottawa, Kansas. The deck was constructed in two placements. The first placement (KS-IC-LC-HPC-2-P1) was constructed on November 3, 2020, starting from the north end of the deck. Placement 1 was completed after placing approximately 120 yd³ (91.7 m³) of concrete on the deck. The remaining portion of the deck (KS-IC-LC-HPC-2-P2) was completed on November 11, 2020. Placement 1 has a length of 50 ft (15.2 m), while Placement 2 has a length of 288 ft (87.8 m). The concrete supplier and the contractor were Builders Choice Concrete and A. M. Cohron & Son, respectively. The bridge has four spans with lengths of 68 ft (20.7 m), 101 ft (30.8 m), 101 ft (30.8 m), and 68 ft (20.7 m), for a total length of 338 ft (103.0 m). The deck has a 40 ft (12.2 m) wide roadway and a 1 ft-3 in. (0.38 m) wide barrier on each side, for a total deck width of 42 ft-6 in. (12.9 m). The nominal deck thickness is 8½ in. (216 mm) with 9½-in. (241-mm) deep overhangs; the deck is supported by steel girders with a skew of 25°.

The fine lightweight aggregate (LWA) used in both placements was an expanded shale stored in an open area at the batch plant. The LWA was prewetted using a lawn sprinkler on top of the aggregate stockpile for at least three days prior to construction day. The stockpile was approximately 7 ft (2.1 m) high, greater than the recommended 5-ft (1.5-m) limit, as shown in Figure 2.49.



Figure 2.49: KS-IC-LC-HPC-2 Lightweight Aggregate Stockpile

Two qualification batches were completed before the construction of the bridge deck. The first qualification batch was completed on June 4, 2020. The mixture contained a binary binder composition, a 30% replacement by weight of portland cement with slag cement. The design paste content and the water-cementitious material (w/cm) ratio were 24.2% (by concrete volume) and 0.43, respectively. The design quantity of internal curing water was 7% (by the weight of binder). The lightweight aggregate was prewetted for more than three days prior to batching, and the design absorption value was 14.1% (OD basis). On the day of batching, the average absorption (OD basis) and the free-surface moisture of the LWA obtained by KU and KDOT representatives were 16.8 and 4.3%, respectively, which differed from the values obtained by the concrete supplier (14.1 [given by the LWA producer] and 8.8%, respectively). With the KDOT approval, the mixture proportions were adjusted, and the concrete supplier batched the concrete averaging the two values (with values of 15.5 and 6.6%, respectively) for the LWA to get 7% of IC water by the weight of binder.

A single truckload with 6 yd³ (4.6 m³) of concrete was batched, with 8 lb/yd³ (5 kg/m³) of water withheld in the truck. No pump was used during the first qualification batch and the concrete

properties were measured out of the truck. Two tests for slump, air content, and temperature were performed. The first test had a slump and an air content of 3½ in. (90 mm) and 6%, respectively, with a concrete temperature of 87 °F (31 °C). To increase the slump, the supplier added back the withheld water (8 lb/yd³ [5 kg/m³]) and added a high-range water-reducing admixture with a dosage of 10.8 oz/yd³ (417.7 mL/m³). To increase the air content, the air-entraining admixture was increased from 5.5 to 6.5 oz/yd³ (212.7 to 251.4 mL/m³). The concrete was mixed for an additional 10 minutes and tested again for the slump and air content. For the second test, the slump and air content of the concrete were 4¾ in. (145 mm) and 8%, respectively, with a concrete temperature of 88 °F (31 °C).

The second qualification batch was completed on October 13, 2020, at the batch plant with representatives of the contractor in attendance. A single truckload with 2 yd³ (1.5 m³) of concrete was batched, with 17 lb/yd³ (10 kg/m³) of water withheld in the truck. The concrete properties (after pumping) after approximately 15 minutes of haul time were out of the specifications for air content (with a value of 6%, lower than the lower Kansas IC-LC-HPC specification limit of 6.5%) and slump (with a value of 6¾ in. [170 mm], well above the upper Kansas IC-LC-HPC specification limit of 5 in. [125 mm]). The concrete temperature was 77 °F (25 °C). For the bridge deck construction, the concrete supplier was required to increase the air-entraining admixture dosage in concrete batches.

2.7.2.1 KS-IC-LC-HPC-2-P1

Placement 1 of the KS-IC-LC-HPC-2 was constructed on November 3, 2020. The LWA stockpile was prewetted for at least three days before batching. The sprinkler was turned off on the morning of November 2, 2020, letting the material drain for approximately 24 hours prior to batching. Upon KU researchers' request, the LWA stockpile was turned several times before collecting a composite sample to measure the LWA absorption and free-surface moisture prior to batching. The average absorption (OD basis), the specific gravity (OD basis), and the free-surface moisture of the LWA obtained by KU and KDOT personnel were 15.5%, 1.85, and 1.25%, respectively.

The initial and actual (based on average of trip tickets) mixture proportions for the first placement of KS-IC-LC-HPC-2 are listed in Table 2.42. KS-IC-LC-HPC-2 had a design *w/cm*

ratio of 0.43, a 30% replacement of cement (by total weight of binder) with Grade 100 slag cement, and a design paste content of 24.2%. The design quantity of internal curing water was 7% (by the weight of binder). Limestone and river sand were used as coarse and fine aggregates, respectively.

Based on the trip tickets, 17 lb/yd³ (10 kg/m³) of water was held from the first five truckloads, reducing the actual *w/cm* ratio to an average of 0.42. Based on the trip tickets, individual paste contents ranged from 23.1 to 24.2%, with an average of 23.8% and the actual quantities of IC water ranged from 6.9 to 7.1%, with an average of 6.9% by total weight of binder. The air-entraining admixture was added at dosages between 1.5 and 4 oz/cwt (1 and 2.6 mL/kg). Mid-range water-reducing and high-range water-reducing admixtures were added to all trucks at a constant dosage of 8 oz/cwt (5.2 mL/kg) and a varied dosage between 3 and 5 oz/cwt (2 and 3.3 mL/kg), respectively, to achieve the desired slump. A portion of the mixing water (either 30 or 40%) was replaced with hot water to control the concrete temperature.

Table 2.42: KS-IC-LC-HPC-2-P1 Mixture Proportions (SSD/PSD Basis)

Material	Mixture proportions (lb/yd ³)		
	Initial	Revised	Actual ^a
Cement (Type I/II)	378	378	378
Grade 100 Slag cement	162	162	162
Water	232	232	225
Fine Lightweight Aggregate	316	280	279
Coarse Aggregate	1671	1683	1681
Fine Aggregate	800	841	841
Chemical Admixture (oz/cwt)			
BASF	Type	Initial	Actual ^a
MB AE-90	Air-Entraining	1.1	1.5-4
Polyheed 900	Mid-Range Water-Reducing	5	8
Glenium 7500	High-Range Water-Reducing	2	3-5

^a Actual values based on average of trip tickets.

Note: 1 lb/yd³ = 0.593 kg/m³, 1 oz/cwt = 0.652 mL/kg

The concrete properties are listed in Table 2.43. Seven tests for slump, air content, and temperature were performed before pumping; two tests were performed after pumping. The first truckload was rejected due to out-of-specifications values for air content and slump, with values

of 4.2% and 1½ in. (40 mm), respectively, before pumping. The second truckload had a 4¼-in. (105-mm) slump, but the air content (5.5%) was still lower than the minimum allowable limit stated in the specifications (6.5%). After redosing the admixtures, a second test was performed, and the air content and slump values increased to 9.9% and 10½ in. (260 mm), respectively. This load was placed in the north abutment. Because of the incorrect free-surface moisture used to develop the batch weights, the concrete supplier had difficulty producing concrete within the specifications throughout the placement. In an attempt to provide concrete with adequate workability, high-range water reducer and air-entraining admixtures were added at the job site to multiple truckloads. The fourth truckload was tested before and after pumping for slump and air content. For tests performed before pumping, the slumps ranged from 4 to 10½ in. (100 to 260 mm), with an average of 5¾ in. (145 mm). The air contents ranged from 6.8 to 9.9%, with an average of 8.6%, within the specifications. Concrete temperatures ranged from 60 to 68 °F (16 to 20 °C). For the two tests performed after pumping, the slumps were 3 and 3½ in. (75 to 90 mm), and the air contents were 8 and 6.2%. The 28-day compressive strengths ranged from 6870 to 7270 psi (47.4 to 48.7 MPa), before pumping.

Table 2.43: Concrete Test Results^a-KS-IC-LC-HPC-2-P1

KS-IC-LC-HPC-2-P1	Slump (in.)	Air content (%)	Concrete temperature (°F)	28-day compressive strength (psi)
Minimum	4	6.8	60	6870
Maximum	10½	9.9	68	7270
Average	5¾	8.6	64	7070

^a Values measured before pumping.

Note: 1 in. = 25.4 mm; °C = (°F-32)×5/9; 1 psi = 6.89×10⁻³ MPa

KS-IC-LC-HPC-2 was located approximately 10 minutes from the batch plant. Placement 1 started at 9:10 am on November 3, 2020, at the north end of the deck and continued to the south end, with the final strike-off at 11:45 am. The concrete was placed using a pump positioned near the north end and consolidated using a machine-mounted gang vibration system with two sets of four spud vibrators each spaced within 15 ft of each other mounted on a moveable

frame, followed by a spud vibrator near the edges of the deck, and finished using a double-drum roller screed followed by one metal pan, as shown in Figure 2.50.



Figure 2.50: Consolidation and Finishing Equipment

During placement, wind speeds at the deck ranged from 0.5 to 1.4 mph (1 to 2 km/hr). Relative humidity at the deck ranged between 38.5 and 50.5%. Ambient air temperature during construction ranged from 61 to 71 °F (16 to 22 °C). These environmental conditions resulted in evaporation rates, ranging from 0.02 to 0.04 lb/ft²/hr (0.1 to 0.2 kg/m²/hr), below the 0.2 lb/ft²/hr (1 kg/m²/hr) specification limit.

As mentioned earlier, the concrete supplier had difficulty producing concrete meeting the specifications throughout the placement, resulting in an increased time between batching and discharging concrete. The time between batching and discharge ranged from 69 to 90 minutes, with an average of 80 minutes. Similar to the construction of KS-IC-LC-HPC-1, construction personnel walked in areas that had been recently vibrated to shovel concrete, as shown in Figure 2.51, causing deconsolidation. As indicated in a number of studies, the loss of consolidation can lead to settlement that can lead to increased cracking (Pendergrass & Darwin, 2014; Khajehdehi & Darwin, 2018; Feng & Darwin, 2020). As discussed in Section 3.3.2.2, no settlement cracking was observed on the deck through the first two years of crack surveys. The tendency to exhibit

cracking over the long term, however, usually becomes apparent only after 36 months (Lindquist et al., 2008; Yuan et al., 2011; Pendergrass & Darwin, 2014).



Figure 2.51: Walking Observed on Freshly Consolidated Concrete

About an hour after construction started, the roller screed broke, resulting in an hour delay between placing and finishing the concrete. While the contractor was placing more concrete on the deck, the concrete was left unconsolidated and unprotected, as shown in Figure 2.52, with the contractor personnel observed walking through the concrete. Crack surveys at an age of 19.7 months, discussed in Section 3.3.2.2, however, did not indicate any cracks in these regions. The time between placement and strike-off ranged from 11 to 61 minutes, with an average of 33 minutes.



Figure 2.52: Concrete Left Unconsolidated and Unprotected Due to Inoperable Roller Screenshot

A highway straightedge was used in place of a bull float. Trowels were used for finishing the edges of the concrete adjacent to the barrier reinforcement on each side of the deck and near the abutments. Significant bleed water was observed on the deck, as indicated by the reflective water sheen in Figure 2.53. While waiting for bleed water to dissipate, construction workers bull floated the deck repeatedly in an attempt to accelerate the evaporation of bleed water. As discussed later in Section 3.3.2.2, scaling damage was observed at multiple spots on the surface of the deck. Over-finishing the deck in the presence of bleed water leads to a thin paste layer with a high w/cm at the concrete surface, which can result in scaling damage.



Figure 2.53: Over-Finishing the Deck in the Presence of Bleed Water

When delivered to the jobsite, the burlap had not been soaked in water (Figure 2.54(a)). Contractor personnel wet the burlap at the job site using a water hose (Figure 2.54(b)), delaying its application. The time between strike-off and curing application ranged from 57 to 70 minutes. The Kansas IC-LC-HPC specifications state that the burlap should be soaked in water for a minimum of 12 hours prior to placement on the deck. Crack surveys (Section 3.3.2.2) indicated an area with surface damage approximately 15 ft (4.6 m) from the north abutment, possibly caused by the direct spraying of water by the contractor from a work bridge on the surface (Figure 2.54(b)) in an attempt to wet the burlap.



Figure 2.54: Burlap Placement of KS-IC-LC-HPC-2 (a) Dry Burlap; (b) Wetting the Burlap on the Deck

Later, ponding was observed along the west edge of the deck, mainly due to the contractor spraying water to wet the burlap, as shown in Figure 2.55. Due to a number of issues observed during the first placement, it was decided to complete the construction of the deck in another placement (KS-IC-LC-HPC-2-P2). KU researchers and KDOT personnel discussed the issues that arose during the first placement. As a point of special interest, this contractor has, on many decks, repeatedly allowed its workers to walk through consolidated concrete, and those decks have cracked far more than others in Kansas, and using dry burlap, not only fails to meet the specifications, it will increase, rather than decrease cracking (Khajehdehi & Darwin, 2018).



Figure 2.55: Ponding Observed on the Deck

2.7.2.2 KS-IC-LC-HPC-2-P2

Placement 2 of the KS-IC-LC-HPC-2 was constructed on November 11, 2020. A new shipment of LWA was delivered to the batch plant. The LWA stockpile was approximately 8 ft (2.4 m) high; it was prewetted for at least three days before batching. The sprinkler was turned off on November 10, 2020, at noon, letting the material drain for approximately 21 hours prior to batching. A composite sample was obtained to measure the LWA absorption and free-surface moisture prior to batching. The average absorption (OD basis) and the free-surface moisture of the LWA obtained by KU and KDOT personnel were 15 and 1.5%, respectively. Due to obtaining similar absorption for LWA, no adjustments were made to the mixture proportions. In contrast to the first placement, the concrete supplier used the values provided by KU and KDOT for the value of the free-surface moisture.

The initial and actual (based on the average of trip tickets) mixture proportions for the second placement of KS-IC-LC-HPC-2 are listed in Table 2.44. Based on the trip tickets, individual w/cm ratios ranged from 0.40 to 0.43, with an average of 0.43, individual paste contents ranged from 23.1 to 24.2%, with an average of 24.1%, and the actual quantities of IC water ranged from 6.5 to 6.9%, with an average of 6.7% by total weight of binder. An air-entraining admixture

was added at a dosage between 2.4 and 4 oz/cwt (1 and 3.3 mL/kg). A mid-range water-reducing and high-range water-reducing admixtures were added to all truckloads at a constant dosage of 8 oz/cwt (5.2 mL/kg) and a varied dosage between 3 oz/cwt and 4 oz/cwt (2 and 3.3 mL/kg), respectively. A portion of the mixing water (20 to 50%) was replaced with hot water to control the concrete temperature.

Table 2.44: KS-IC-LC-HPC-2-P2 Mixture Proportions (SSD/PSD Basis)

Material	Mixture proportions (lb/yd ³)		
	Initial	Actual ^a	
Cement (Type I/II)	378	378	
Grade 100 Slag cement	162	162	
Water	232	230	
Fine Lightweight Aggregate	280	279	
Coarse Aggregate	1683	1680	
Fine Aggregate	841	840	
Chemical Admixture (oz/cwt)			
BASF	Type	Initial	Actual ^a
MB AE-90	Air-Entraining	1.1	2.4-4
Polyheed 900	Mid-Range Water-Reducing	5	8
Glenium 7500	High-Range Water Reducing	2	3-4

^a Actual values based on average of trip tickets.

Note: 1 lb/yd³ = 0.593 kg/m³, 1 oz/cwt = 0.652 mL/kg

The concrete properties are listed in Table 2.45. As with the first placement, the concrete supplier had difficulty producing concrete within the specifications throughout the placement, and the dosage rates of the high-range water reducer and air-entraining admixtures were increased at the job site in multiple truckloads. Twenty-five tests for slump, air content, and temperature were performed before pumping; seven tests were performed after pumping. The concrete supplier withheld 17 lb/yd³ (10 kg/m³) of water in the first truckload, resulting in a 2-in. (50-mm) slump after pumping. KDOT personnel asked the concrete supplier to add all of the mixing water at the batch plant in all trucks afterward before sending them to the job site. For tests performed before

pumping, the slumps ranged from 4½ to 10¼ in. (115 to 260 mm), with an average of 7 in. (175 mm). The air contents ranged from 6.1 to 10%, with an average of 8%, within the specifications, and the concrete temperatures ranged from 54 to 72 °F (12 to 22 °C). For the seven tests performed after pumping, the slumps ranged from 2 to 7¼ in. (50 to 185 mm), with an average of 4¾ in. (120 mm), and the air contents ranged from 6.9 to 11%, with an average of 8.3%. Concrete temperatures ranged from 68 to 75 °F (20 to 24 °C). The 28-day compressive strengths ranged from 6700 to 7010 psi (46.2 to 48.3 MPa), before pumping.

Table 2.45: Concrete Test Results^a-KS-IC-LC-HPC-2-P2

KS-IC-LC-HPC-2-P2	Slump (in.)	Air content (%)	Concrete temperature (°F)	28-day compressive strength (psi)
Minimum	2	6.9	68	6700
Maximum	7¼	11	75	7010
Average	4¾	8.3	71	6850

^a Values measured after pumping.

Note: 1 in. = 25.4 mm; °C = (°F-32)×5/9; 1 psi = 6.89×10⁻³ MPa

Placement 2 started at 9:16 am on November 11, 2020, with the final strike-off at 5:35 pm. The concrete was placed using three pumps (the first pump was positioned near the north end, the second pump was located below the bridge, between the second and third spans, and the third pump was placed near the south end of the bridge). The concrete was consolidated and finished using the same equipment employed for constructing the first placement.

During placement, wind speeds at the deck ranged from 0 to 0.7 mph (0 to 1 km/hr). Relative humidity at the deck ranged between 31.7 and 53.6%. Ambient air temperature during construction ranged from 40 to 67 °F (4 to 19 °C). These environmental conditions resulted in evaporation rates ranging from 0.02 to 0.04 lb/ft²/hr (0.1 to 0.2 kg/m²/hr), below the 0.2 lb/ft²/hr (1 kg/m²/hr) specification limit.

Similar to the construction of KS-IC-LC-HPC-2-P1, construction personnel walked in areas that had been recently vibrated to shovel concrete, as shown in Figure 2.56, causing deconsolidation of the concrete. This occurred, however, only at the beginning of this placement. Crack surveys at an age of 19.7 months (Section 3.3.2.2), however, did not indicate any cracks in

these regions. The time between placement and strike-off ranged from 15 to 55 minutes, with an average of 38 minutes.



Figure 2.56: Walking Observed on Freshly Consolidated Concrete

One hour after beginning of the placement, one of the two sets of the gang vibrators failed due to hydraulic issues, and therefore, contractor personnel had to manually push the machine-mounted gang vibrators into the concrete, as shown in Figure 2.57. The hydraulic issues were fixed within 15 minutes, and consolidation resumed with both sets of gang vibrators.



Figure 2.57: Malfunctioning of the Machine-Mounted Gang Vibrators

According to Kansas IC-LC-HPC specifications, no finishing aids are permitted. In spite of this, the contractor applied a finishing aid on the concrete for the entire deck, as shown in Figure 2.58. The use of the finishing aid increases the w/cm ratio at the surface, which may also contribute to increased scaling (Section 3.3.2.2). This shortcoming was pointed out to the contracted (non-KDOT) inspector who said that this was “not a big deal at this point”.

A fogging system was mounted on the backside of the finishing equipment. On one occasion, one of the pipes in the fogging system deposited water droplets on the concrete surface, as shown in Figure 2.59. Contractor personnel were notified about this incident, which was then resolved.



Figure 2.58: Applying Finishing Aid to the Concrete Surface

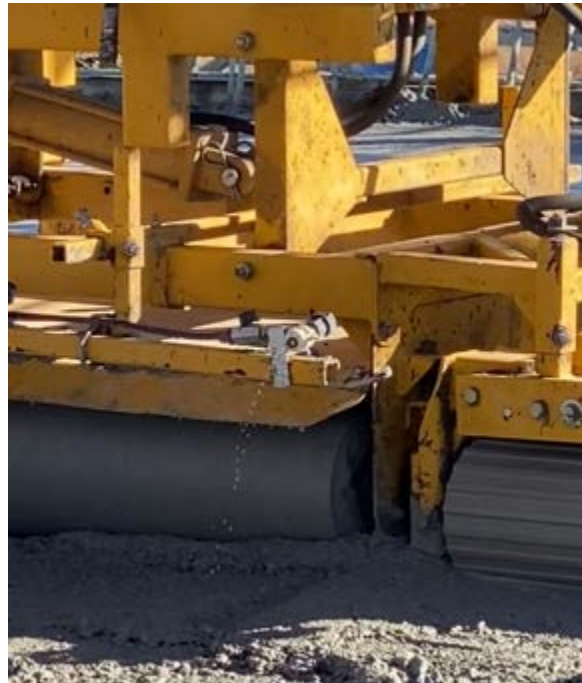

Figure 2.59: Malfunctioning of the Fogging System Mounted on the Finishing Machine

A highway straight edge was used in place of a bull float. Trowels were used for finishing the edges of the concrete adjacent to the barrier reinforcement on each side of the deck and near abutments. Significant bleed water was observed on the deck, as indicated by the reflective water sheen shown in Figure 2.60. As observed for the first placement, contractor personnel worked the

excess water back into the concrete surface. Some scaling damage was observed in these regions (Section 3.3.2.2).

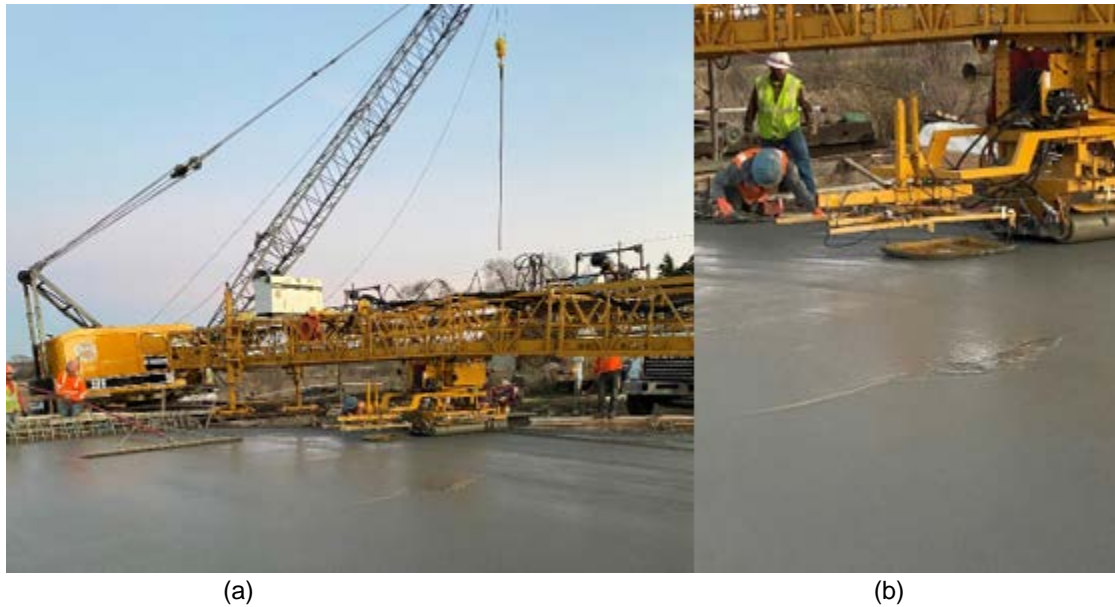

Figure 2.60: Over-Finishing the Deck in the Presence of Bleed Water (a) Overview; (b) Close-Up View

As with the KS-IC-LC-HPC-2-P1, contractor personnel wet the burlap at the job site using a water hose, delaying its application. The time between strike-off and application of burlap ranged from 18 to 152 minutes, with an average of 88 minutes. According to the Kansas IC-LC-HPC specifications, two layers of wet burlap should be applied on the deck, one within 15 and another within 10 minutes of strike-off by the screed.

2.7.3 KS-IC-LC-HPC-3

KS-IC-LC-HPC-3 is a two-lane bridge that carries traffic on 199th St. over I-35 in Edgerton, Kansas. The deck was constructed in one placement on September 16, 2021. The concrete supplier and the contractor were Fordyce and Pyramid Contractors, respectively. The bridge has four spans with lengths of 125 ft (38.1 m), 180 ft (54.9 m), 180 ft (54.9 m), and 125 ft (38.1 m) for a total length of 610 ft (186 m). The deck has a 41 ft (12.5 m) wide roadway and a 1 ft (0.3 m) wide barrier on each side of the deck, for a total deck width of 43 ft (13.1 m). The nominal deck thickness

is 8½ in. (216 mm) with 9½-in. (241-mm) thick overhangs; the deck is supported by steel girders with a skew of -55° 8' 20".

The LWA used in KS-IC-LC-HPC-3 was an expanded clay stored in an open area at the batch plant. The LWA was prewetted using an oscillating sprinkler on top of the aggregate stockpile (shown in Figure 2.61). The stockpile was approximately 8 ft (2.4 m) high, greater than the recommended 5-ft (1.5-m) limit.



Figure 2.61: KS-IC-LC-HPC-3 Lightweight Aggregate Stockpile

A qualification slab was placed on May 5, 2020, with KU and KDOT personnel in attendance to verify the concrete workability, pumpability, and finishability. The LWA was prewetted for three weeks, but it was allowed to drain for only two hours before batching. The absorption of the lightweight aggregate measured by KU and KDOT personnel was 40% (OD basis, on average), higher than the design value (30%, OD basis). Longer prewetting of the materials and failure to stop sprinkling the stockpile (24 hours before batching) are the probable reasons for the higher value. No adjustments were made to the mixture proportions based on the

differences in the lightweight aggregate properties from those used in the original design and batched for the qualification slab. Having a higher absorption than indicated has the potential of holding excess water with the way moisture corrections are made and can lead to pumping issues and a higher than intended amount of internal curing water (8.1 instead of 7%). The concrete supplier used the value obtained by KU and KDOT for the free-surface moisture (7%) of LWA, accounting for the actual moisture content.

A single truck (with a capacity of 7.5 yd³ [5.7 m³]) was batched. The qualification slab was located near an Ace Hardware store in Gardner, Kansas. The slab had dimensions of 33 ft (10.0 m) by 26 ft (7.9 m) with a depth of 6 in. (152 mm), as shown in Figure 2.62.



Figure 2.62: The Qualification Slab for KS-IC-LC-HPC-3

The mixture had a ternary binder composition (a 30% replacement by weight of binder with slag cement and a 2% replacement by weight of binder with silica fume). The design paste content and the water-to-cementitious material (w/cm) ratio were 24.4% (by concrete volume) and 0.45, respectively. The design quantity of internal curing water was 7% (by the weight of binder). The concrete properties were tested before and after pumping at the job site. The air content and slump were 7% and 6½ in. (165 mm), respectively, before pumping. After adding 4 oz/yd³

(155 mL/m³) of air-entraining admixture, the air content measured after pumping was 7.9%. Concrete and ambient temperatures were 65 and 59 °F (18 and 15 °C), respectively.

The concrete was placed using a pump, consolidated using a single hand-held vibrator, and finished by a single-drum roller screed, as shown in Figure 2.63. Application of curing was not observed. No issues were observed, and KDOT approved the qualification placement.



Figure 2.63: The Qualification Slab Placement Equipment

The sprinkler was turned off on the evening of September 15, 2021, letting the material drain approximately 9 hours prior to batching. Upon KU and KDOT researchers' request, the LWA stockpile was turned several times before collecting a composite sample to measure the LWA absorption and free surface moisture prior to batching. The absorption of the lightweight aggregate measured by KU and KDOT personnel was 43% (OD basis, on average), higher than the design value (30%, OD basis). No adjustments, however, were made to the mixture proportions based on the differences in lightweight aggregate properties from those used in the original mixture proportions, which resulted in 8.5% of IC water (on average) rather than the design value of 7%.

The initial and actual (based on the average of trip tickets) mixture proportions used for KS-IC-LC-HPC-3 are listed in Table 2.46. Limestone (with two maximum aggregate sizes of ½ and ¾ in. [12.5 and 19 mm]) and river sand were used as coarse and fine aggregates, respectively. There were 87 trucks used for the placements. Each truck contained 10 yd³ (7.6 m³) of concrete.

Based on the trip tickets, 4 lb/yd³ (2 kg/m³) of water was held from all truckloads, reducing the actual *w/cm* ratio to an average of 0.44. Prior to casting, KU and KDOT personnel measured a free-surface moisture of 5% (on average), which was used initially (in 34 truckloads) by the concrete supplier. The concrete supplier, however, reduced the free-surface moisture used for calculating batch weights from 5 to 0% throughout the placement. Based on the trip tickets, individual paste contents ranged from 22.0 to 24.8%, with an average of 24.0%, and the actual quantities of IC water ranged from 8.3 to 9.5%, with an average of 8.5% by total weight of binder. A water-reducing admixture was added to the trucks at dosages between 3 and 3.5 oz/cwt (1.9 and 2.3 mL/kg) to achieve the desired slump. Due to high air temperatures during the construction (between 64 and 96 °F [18 and 36 °C]), the concrete supplier used chilled water and ice to control the concrete temperature. KDOT inspectors also had difficulty tracking the amount of water in the trucks, and believed that the concrete supplier did not account for the addition of ice as part of the mixing water; which resulted in higher *w/cm* ratios (between 0.47 to 0.56) and lower compressive strengths than intended.

Table 2.46: KS-IC-LC-HPC-3 Mixture Proportions (SSD/PSD Basis)

Material		Mixture proportions (lb/yd ³)	
		Initial	Actual ^a
Cement (Type I/II)		361	360
Grade 100 slag cement		159	159
Silica Fume		10	10
Water		238	231
Fine lightweight aggregate		161	162
¾ in. Coarse aggregate		1299	1304
½ in. Coarse aggregate		272	278
Fine aggregate		1098	1097
Chemical Admixture (oz/cwt)			
Euclid	Type	Initial	Actual ^a
Eucod AEA 92S	Air-Entraining	0.5	0.6-1.1
Plastol 6420	Water-Reducing	4.5	3-3.5

^a Actual values based on average of trip tickets.

Note: 1 lb/yd³ = 0.593 kg/m³, 1 oz/cwt = 0.652 mL/kg

The concrete properties and compressive strengths are listed in Table 2.47. Seventeen tests for slump, air content, and temperature were performed during construction, all after pumping. Two trucks experienced overtime and were rejected. The slumps ranged from 5 to 9 in. (125 to 230 mm), with an average of 5¾ in. (125 mm). The air content ranged from 6.2 to 8.8%, with an average of 7%, within the specifications. Concrete temperatures ranged from 71 to 81 °F (22 to 27 °C), with an average of 76 °F (24 °C) and 28-day compressive strengths ranged from 3150 to 3990 psi (21.7 to 27.5 MPa), after pumping. This was the only deck in Kansas with a 28-day compressive strength below 5000 psi. The low strength was likely the result of not accounting for the ice added to the mixture.

Table 2.47: Concrete Test Results-KS-IC-LC-HPC-3

KS-IC-LC-HPC-3	Slump (in.)	Air content (%)	Concrete temperature (°F)	28-day compressive strength (psi)
Minimum	5	6.2	71	3150
Maximum	9	8.8	81	3990
Average	5¾	7	76	3570

Note: 1 in. = 25.4 mm; °C = (°F-32)×5/9; 1 psi = 6.89×10⁻³ MPa

The KS-IC-LC-HPC-3 bridge deck was located approximately 15 minutes away from the batch plant. Placement started at 3:10 am on September 16, 2021, at the east end of the deck and continued to the west end with final strike-off at 5:00 pm. The concrete was placed using three pumps (the first pump was positioned near the east end, the second pump was located below the bridge, between the second and third spans, and the third pump was placed near the west end of the bridge), consolidated using a manually operated gang vibration system, including four hand vibrators mounted on a moveable frame followed by a spud vibrator near the edges of the deck, and finished using a double-drum roller screed followed by two metal pans and a burlap drag system mounted on a work bridge.

During placement, wind speeds at the deck ranged from 0.2 to 3.2 mph (0.3 to 5.1 km/hr). Relative humidity at the deck ranged between 44.9 and 83.7%. Ambient air temperature during construction ranged from 64 to 96 °F (18 to 36 °C). These environmental conditions resulted in evaporation rates, ranging from 0.02 to 0.04 lb/ft²/hr (0.1 to 0.2 kg/m²/hr), below the 0.2 lb/ft²/hr

(1 kg/m²/hr) specification limit. To help reduce the evaporation rate near the surface, the contractor occasionally turned on a fogging system mounted on the backside of the finishing equipment. On one occasion, shortly after concrete placement started, the fogging system sprayed the mist directly into the concrete surface, causing excessive water to deposit on the deck surface, as shown in Figure 2.64. Contractor personnel were notified about this incident, and the direction of the nozzles was corrected. Approximately 40 ft (12.1 m) from the east end of the deck, one of the pipes in the fogging system again caused water droplets to accumulate on the surface, as shown in Figure 2.65. The droplets were worked back into the concrete surface as the metal pans passed over it, increasing a layer of excess paste on the surface. After this incident, KDOT personnel directed the contractor to turn off the fogging equipment for the rest of the construction.

According to Kansas IC-LC-HPC specifications, no finishing aids are permitted. In spite of this, the contractor applied a finishing aid on the concrete for the first 50 ft (15.2 m) at the east end, as shown in Figure 2.66. The use of the finishing aid increases the *w/cm* ratio at the surface, which may also contribute to increased scaling (Section 3.3.2.3). Use of the finishing aid was stopped after the problem was pointed out to KDOT and contractor personnel.



Figure 2.64: Excessive Water on the Deck (a) Unadjusted Nozzles; (b) Ponded Water on the Surface



Figure 2.65: A Leaking Pipe Leaving Water Droplets on the Deck Surface



Figure 2.66: Applying Finishing Aid to the Concrete Surface

A 65-minute delay occurred about 100 ft (30.5 m) from the west end of the deck due to equipment problems. The time between placement and strike-off ranged from 3 to 65 minutes, with an average of 18 minutes.

At first, it was observed that the contractor was bull floating the deck in the longitudinal direction. A KU researcher asked the contractor to bull float in the transverse direction to prevent delays in the application of curing. Also, as indicated by the reflective water in Figure 2.67, a bull float was repeatedly used in the longitudinal direction while the excess water was visible on the surface. Crack surveys, discussed later in Section 3.3.2.3, showed a number of cracks and scaling damage, mainly at these locations (spans 3 and 4).

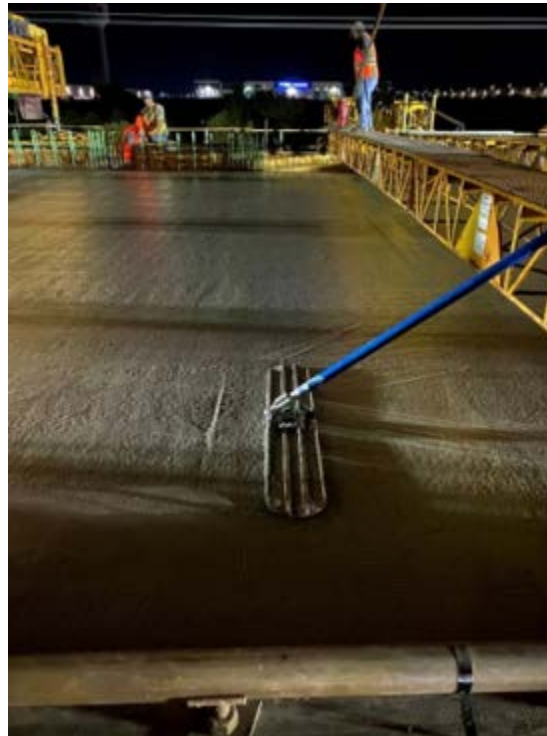

Figure 2.67: Bull Floating in the Longitudinal Direction Along with Sheen Water on the Surface

A single layer of wet burlap was placed within 15 minutes of bull floating. The burlap rolls were soaked for at least 24 hours prior to construction. Later during construction, as the temperature began to rise, it was observed that the burlap on some portions of the deck had dried. The contractor was asked to rewet the burlap by sprinkling it with a garden hose, as shown in

Figure 2.68. It was, however, observed that some portions of the deck had not been wet completely. The time between strike-off and wet burlap application ranged from 14 to 75 minutes, with an average of 37 minutes.



Figure 2.68: Rewetting the Burlap on the Deck

Chapter 3 – Evaluation of Cracking Performance of Internally Cured Low-Cracking High-Performance Concrete (IC-LC-HPC) and Control Bridge Decks

3.1 General

This chapter evaluates cracking performance of internally cured low-cracking high-performance concrete (IC-LC-HPC) and associated Control decks constructed in Minnesota and Kansas. The construction procedures of these decks are described in Chapter 2. Annual crack surveys were performed on the bridge decks between 2017 and 2023 to evaluate cracking in terms of crack density (expressed in m/m^2). This chapter describes the crack survey methods, discusses crack survey results, and presents the crack maps showing crack distribution, crack density, as well as bridge deck information for the most recent crack surveys of each deck. The cracking performance of IC-LC-HPC decks is compared with survey data obtained from previous studies, including LC-HPC decks and paired control decks in Kansas and a number of IC and control decks in Utah and Indiana. Crack maps from previous surveys in Minnesota are included in Appendix D.

3.2 Crack Survey Method

The crack surveys were performed using a standardized procedure that enables survey crews to provide consistent results (Lindquist et al., 2005, 2008; Pendergrass & Darwin, 2014). The crack survey procedure is summarized next. The full bridge deck survey specifications are provided in Appendix E.

3.2.1 Crack Survey Procedure

Crack surveys are conducted on a day with a minimum air temperature of 60 °F (16 °C), with weather that is mostly sunny. Crack surveys are only conducted when the bridge deck surface is completely dry. No surveys are permitted on a wet surface. Crack survey results obtained under conditions that don't meet these requirements are invalid.

A plan view of the deck for drawing the crack map, with a scale of 1 in. = 10 ft (25.4 mm = 3.1 m) and a 10 × 10 ft (3.1 × 3.1 m) grid, is prepared before conducting the cracking survey. To establish the scaled length and location of the cracks, a 5 ft × 5 ft (1.5 m × 1.5 m) grid with a scale

of 1 in. = 10 ft (25.4 mm = 3.1 m) is printed separately and is placed underneath the crack map. The grid should be aligned so that the grid points spaced at 5 ft × 5 ft (1.5 m × 1.5 m) match the grid lines on the crack map. The crack map also indicates the north compass direction to further assist the crack survey crews.

State department of transportation (DOT) crews provide traffic control by closing at least one lane to traffic. The surveyors start marking the grids on the deck at 40-ft (12.1-m) increments in the longitudinal and 5-ft (1.5-m) increments in the transverse directions using sidewalk chalk corresponding with the scaled crack map. The surveyors then only mark cracks with sidewalk chalk that are visible at waist height when bending at the waist as they walk over the deck. Once a crack is observed, surveyors are allowed to bend closer to the deck to complete marking the crack. Once a crack is marked, surveyors must resume the identification of cracks that are only visible from waist height. Each portion of the deck is surveyed by at least two surveyors. The cracks marked on the bridge deck are transferred to the crack map, using the 5 ft × 5 ft (1.5 m × 1.5 m) grid map. The hand-drawn map is used to calculate the crack density of the bridge deck.

To calculate crack density, the hand-drawn map is scanned and converted into an AutoCAD file, and the crack lengths are measured using the built-in AutoCAD command, Data Extraction. The output is an Excel file in a CAD output folder showing the measured crack lengths of the individual cracks (in AutoCAD units). The summation of these measurements is the total crack length in AutoCAD units. Two scaling factors are defined to convert the AutoCAD unit measurements. One scaling factor is defined as the ratio between the actual bridge length and the length of the bridge drawn in AutoCAD (measured after scanning the hand-drawn crack map into AutoCAD). Similarly, the second scaling factor is defined as the ratio between the actual bridge width and the width of the bridge in AutoCAD. The average of these two scaling factors is used for the calculations. The actual crack lengths are obtained by multiplying the crack lengths in AutoCAD units by the average scaling factor. It is important to note that because of the scaling factor, the cracks shown on the crack map images in this report can be deceiving in terms of the length of the crack. The images shown in this report range in size from $\frac{1}{4}$ to $\frac{3}{8}$ of the crack survey maps and from $\frac{1}{480}$ to $\frac{1}{320}$ of the bridge decks. This difference in scale can be deceiving. As will be demonstrated, for example in Figure 3.11, cracks that are just $\frac{1}{16}$ in. (1.6 mm) long in the

images represent cracks that are 2.4 ft (0.7 m) long on the bridge deck. The crack density is calculated by dividing the crack length by the deck area and reported in m/m^2 .

3.2.2 Crack Width

A number of randomly selected cracks from the bridge deck are measured for crack width. Cracks are selected to be representative based on length (short or long), orientation (transverse, parallel, or diagonal to traffic), and shape (straight or nonlinear). The width of cracks generally increases along with crack density. The widest point of the crack is measured and reported as the crack width. A bank card-sized crack width comparator, with an accuracy of 0.001 in. (0.03 mm), is used for the measurements.

3.3 Crack Surveys and Results

The cracking performance of the 11 bridge decks in Minnesota (nine IC-LC-HPC and two Control decks) and three IC-LC-HPC bridge decks in Kansas surveyed in this study is described in this Section.

3.3.1 Minnesota Bridge Deck Crack Survey Results

Crack surveys on two pedestrian bridge decks constructed in 2016, MN-IC-LC-HPC-1 and MN-Control-1, were performed in June 2017 (approximately 9 months after construction), May 2018 (approximately 19 months after construction), June 2019 (approximately 32 months after construction), June 2020 (approximately 45 months after construction), June 2021 (approximately 57 months after construction), and May 2022 (approximately 68 months after construction). Crack surveys on the three bridge decks constructed in 2017 (MN-IC-LC-HPC-2, MN-IC-LC-HPC-3, and MN-Control-2), which contain a 2-in. (50-mm) overlay, were performed in May 2018 (8 to 10 months after construction of the subdecks), June 2019 (21 to 23 months after construction of the subdecks), and July 2020 (34 to 37 months after construction of the subdecks). Crack surveys on one bridge deck constructed in 2018, MN-IC-LC-HPC-4, were performed in September 2019 (approximately 16 months after construction), June 2021 (approximately 37 months after construction), and May 2022 (approximately 48 months after construction). Crack surveys on two bridge decks constructed in 2019, MN-IC-LC-HPC-5 (a pedestrian bridge) and MN-IC-LC-HPC-

6, were performed in June and August 2020, respectively (approximately 11 months after construction), June 2021 (21 to 23 months after construction), and May 2022 (32 to 34 months after construction). Crack surveys on three bridge decks constructed in 2020, MN-IC-LC-HPC-7, MN-IC-LC-HPC-8, and MN-IC-LC-HPC-9, were performed in June 2021 (9 to 12 months after construction) and May 2022 (20 to 23 months after construction).

3.3.1.1 MN-IC-LC-HPC-1

MN-IC-LC-HPC-1 is a pedestrian bridge deck located at Mackubin St. over I-94 in St. Paul. The deck was constructed in one placement on September 22, 2016. This deck has been surveyed six times (Surveys 1 to 6), exhibiting very low crack densities (below 0.02 m/m^2). Survey 1 was performed at a deck age of 9.2 months with a crack density of 0.013 m/m^2 . The crack density remained relatively constant between the second and fourth years after construction, with a crack density of 0.007 m/m^2 , with cracks observed only over the center pier during the first five years after the construction, as shown in Figure 3.1. Some scaling damage and a decrease in the crack density to zero was observed during Survey 6. The scaling may have been due to the hour plus delay in placing the wet burlap on the deck. This decrease in cracking may be the result of a reduction in the camber of the prestressed concrete girders and concrete creep. The most recent crack maps (Surveys 4, 5, and 6 performed at deck ages of 45.0, 56.8, and 68.0 months, respectively) are shown in Figures 3.2 to 3.4. Additional details associated with Surveys 1 to 3 of MN-IC-LC-HPC-1 are documented by Lafikes et al. (2020). The average crack width decreased from 0.004 in. (0.10 mm) for Survey 1 to 0.002 in. (0.05 mm) for Survey 5, and eventually, to 0.000 in. (0.00 mm) for Survey 6.

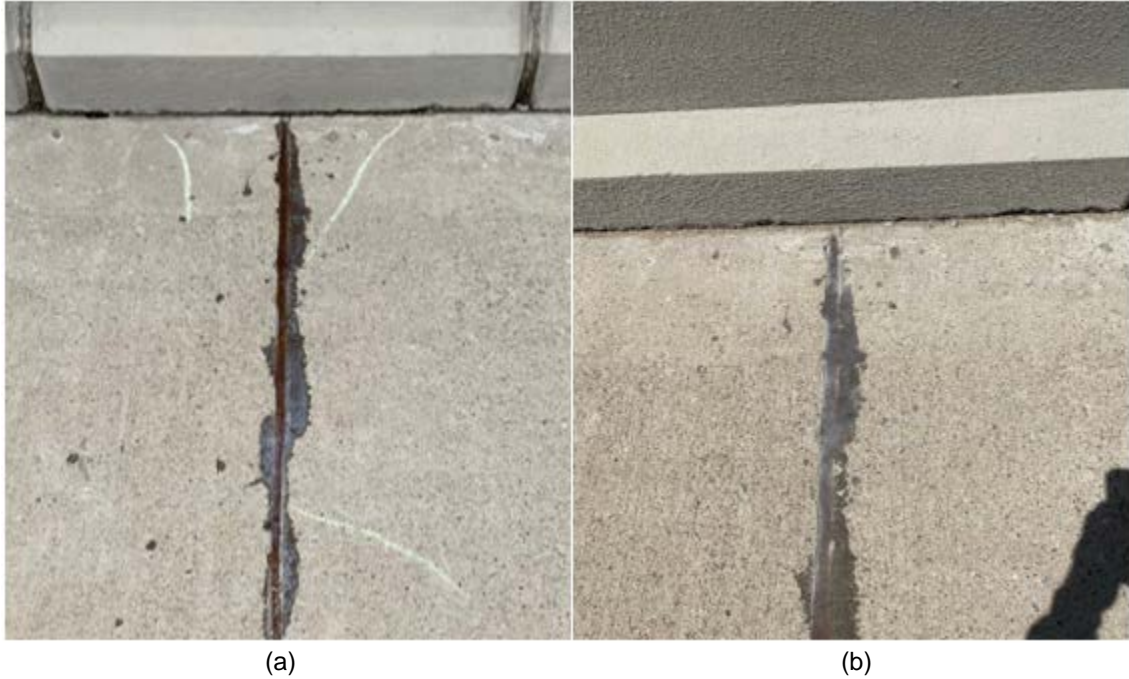
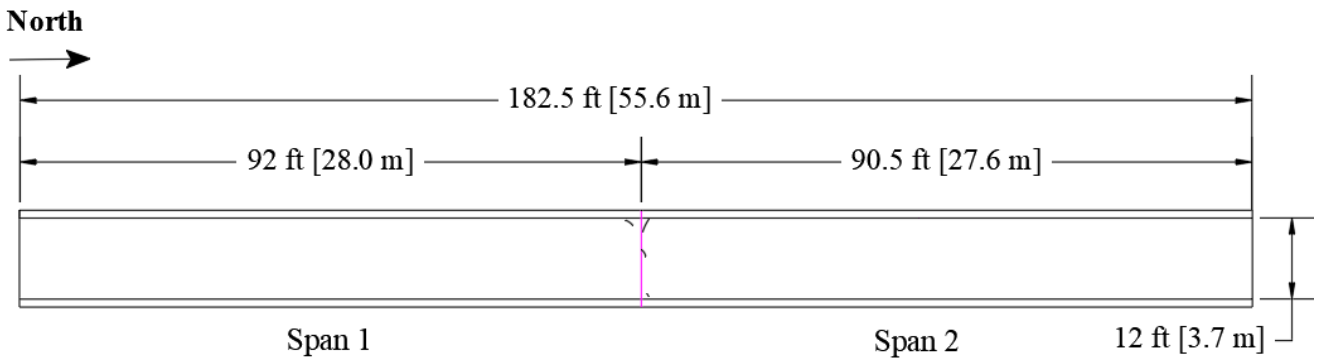
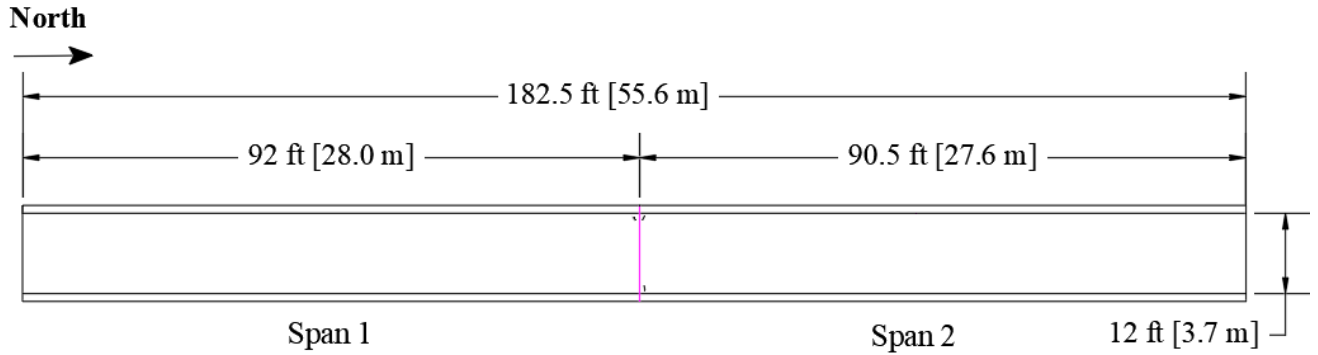

Figure 3.1: Comparison of the Center Pier of MN-IC-LC-HPC-1 (a) From Survey 5; (b) From Survey 6



Bridge ID: MN-IC-LC-HPC-1	Bridge Length: 182.5 ft (55.6 m)	Bridge Age: 45.0 months
Bridge Number: 62892	Bridge Width: 12.0 ft (3.7 m)	Crack Density: 0.007 m/m ²
Bridge Location: Mackubin St. over I-94, St. Paul, MN	Skew: 0°	Span 1: 0.004 m/m ²
Construction Date: 9/22/2016	Number of Spans: 2	Span 2: 0.011 m/m ²
Crack Survey Date: 6/22/2020	Span 1: 92.0 ft (28.0 m)	
	Span 2: 90.5 ft (27.6 m)	
	Number of Placements: 1	

Figure 3.2: Crack Map for MN-IC-LC-HPC-1 (Survey 4)



Bridge ID: MN-IC-LC-HPC-1	Bridge Length: 182.5 ft (55.6 m)	Bridge Age: 56.8 months
Bridge Number: 62892	Bridge Width: 12.0 ft (3.7 m)	Crack Density: 0.003 m/m ²
Bridge Location: Mackubin St. over I-94, St. Paul, MN	Skew: 0°	Span 1: 0.002 m/m ²
	Number of Spans: 2	Span 2: 0.004 m/m ²
Construction Date: 9/22/2016	Span 1: 92.0 ft (28.0 m)	
Crack Survey Date: 6/14/2021	Span 2: 90.5 ft (27.6 m)	
	Number of Placements: 1	

Figure 3.3: Crack Map for MN-IC-LC-HPC-1 (Survey 5)

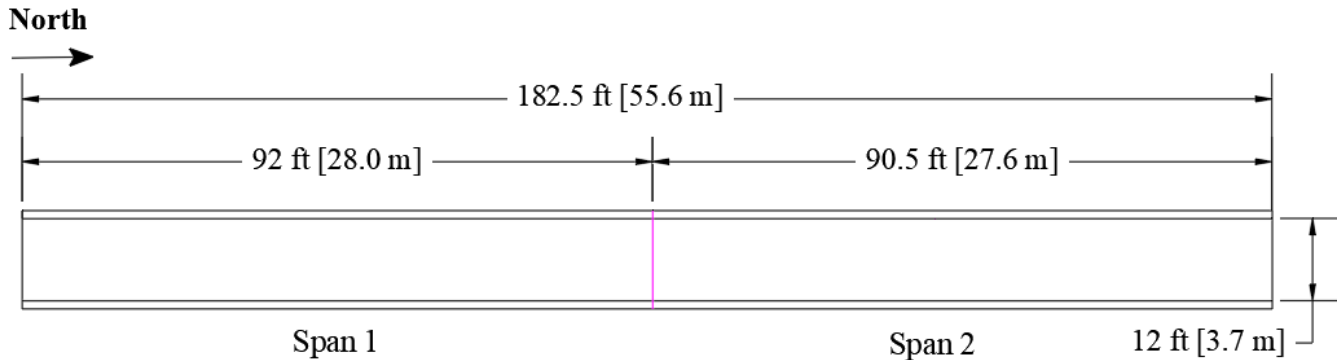

Bridge ID: MN-IC-LC-HPC-1	Bridge Length: 182.5 ft (55.6 m)	Bridge Age: 68.0 months
Bridge Number: 62892	Bridge Width: 12.0 ft (3.7 m)	Crack Density: 0.000 m/m ²
Bridge Location: Mackubin St. over I-94, St. Paul, MN	Skew: 0°	Span 1: 0.000 m/m ²
	Number of Spans: 2	Span 2: 0.000 m/m ²
Construction Date: 9/22/2016	Span 1: 92.0 ft (28.0 m)	
Crack Survey Date: 5/23/2022	Span 2: 90.5 ft (27.6 m)	
	Number of Placements: 1	

Figure 3.4: Crack Map for MN-IC-LC-HPC-1 (Survey 6)

3.3.1.2 MN-Control-1

The associated control deck for MN-IC-LC-HPC-1, MN-Control-1, is a pedestrian bridge deck located at Grotto St. over I-94 in St. Paul. The deck was constructed in one placement on September 28, 2016. This deck has been surveyed six times, exhibiting low crack densities (below 0.05 m/m^2). MN-Control-1, in general, exhibited higher crack densities than MN-IC-LC-HPC-1. Cracks were only observed near the contraction joint at the center pier, with crack lengths somewhat longer than MN-IC-LC-HPC-1. Survey 1 was performed at a deck age of 9 months with a crack density of 0.034 m/m^2 . As with MN-IC-LC-HPC-1, the deck exhibited decreased crack densities within the six years after the construction. The deck had crack densities of 0.032, 0.029, 0.027, and 0.024 m/m^2 for Surveys 2, 3, 4, and 5, respectively; and 0.021 m/m^2 for Survey 6, with crack widths ranging from 0.013 to 0.020 in. (0.33 to 0.51 mm), with an average of 0.016 in. (0.41 mm). The specifications for high-performance concrete (HPC) followed in the construction of MN-Control decks in Minnesota differ from those used in construction of Control decks in Kansas. MN-Control subdecks in this study contained a binary cementitious system with a 25 or 35% replacement of cement (by total weight of binder) with Class F fly ash and paste contents of only 26.7 or 26.9%, while Kansas Control subdecks had either portland cement as the only binder with paste contents between 25.6 and 27.1% (both low) or a 20% replacement of cement (by total weight of binder) with Class F fly ash, with a paste content of 29% (high). The effects of paste content on the cracking performance of bridge decks have been addressed in numerous studies (Schmitt & Darwin, 1995; Miller & Darwin, 2000; Lindquist et al., 2005; Yuan et al., 2011; Pendergrass & Darwin, 2014; Khajehdehi & Darwin, 2018; Feng & Darwin, 2020; Khajehdehi et al., 2021). Schmitt and Darwin (1999) observed that concrete decks with a cement paste content greater than 27% (by concrete volume) exhibited significantly greater cracking compared to decks with lower paste contents. As a result, crack densities of MN-Control-1 (with a low paste content) are expected to be lower than that of the Kansas Control decks with higher paste contents. The most recent crack maps (Surveys 4, 5, and 6 performed at a deck age of 44.8, 56.6, and 67.9 months, respectively) are shown in Figures 3.5 to 3.7. Additional details associated with Surveys 1 to 3 of MN-Control-1 are documented by Lafikes et al. (2020).

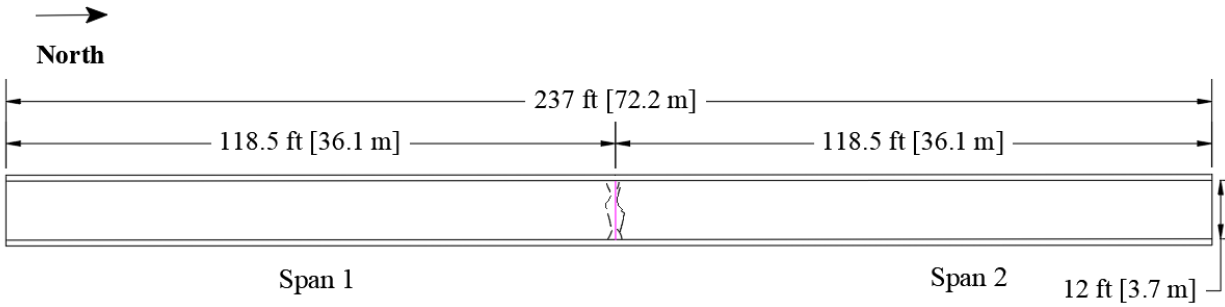

Bridge ID: MN-Control-1	Bridge Length: 237 ft (72.2 m)	Bridge Age: 44.8 months
Bridge Number: 62800	Bridge Width: 12.0 ft (3.7 m)	Crack Density: 0.027 m/m ²
Bridge Location: Grotto St. over I-94, St. Paul, MN	Skew: 0°	Span 1: 0.023 m/m ²
Construction Date: 9/28/2016	Number of Spans: 2	Span 2: 0.032 m/m ²
Crack Survey Date: 6/22/2020	Span 1: 118.5 ft (36.1 m)	
	Span 2: 118.5 ft (36.1 m)	
	Number of Placements: 1	

Figure 3.5: Crack Map for MN-Control-1 (Survey 4)

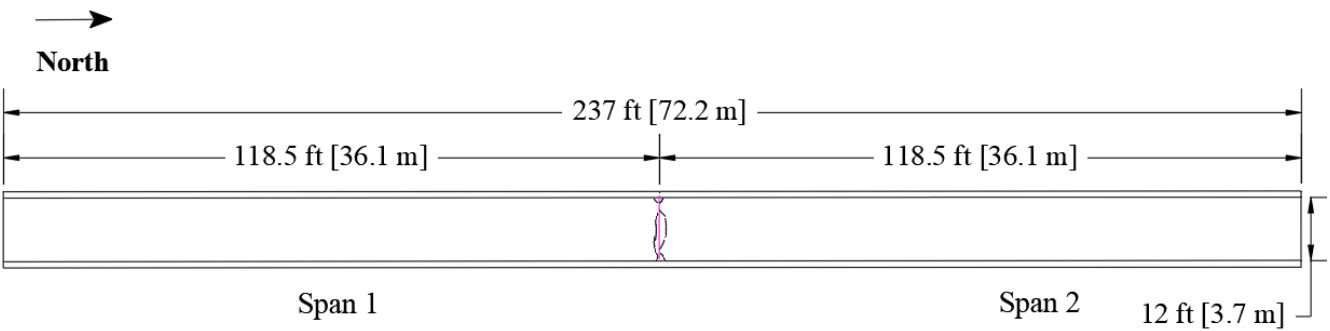

Bridge ID: MN-Control-1	Bridge Length: 237 ft (72.2 m)	Bridge Age: 56.6 months
Bridge Number: 62800	Bridge Width: 12.0 ft (3.7 m)	Crack Density: 0.024 m/m ²
Bridge Location: Grotto St. over I-94, St. Paul, MN	Skew: 0°	Span 1: 0.025 m/m ²
Construction Date: 9/28/2016	Number of Spans: 2	Span 2: 0.022 m/m ²
Crack Survey Date: 6/14/2021	Span 1: 118.5 ft (36.1 m)	
	Span 2: 118.5 ft (36.1 m)	
	Number of Placements: 1	

Figure 3.6: Crack Map for MN-Control-1 (Survey 5)

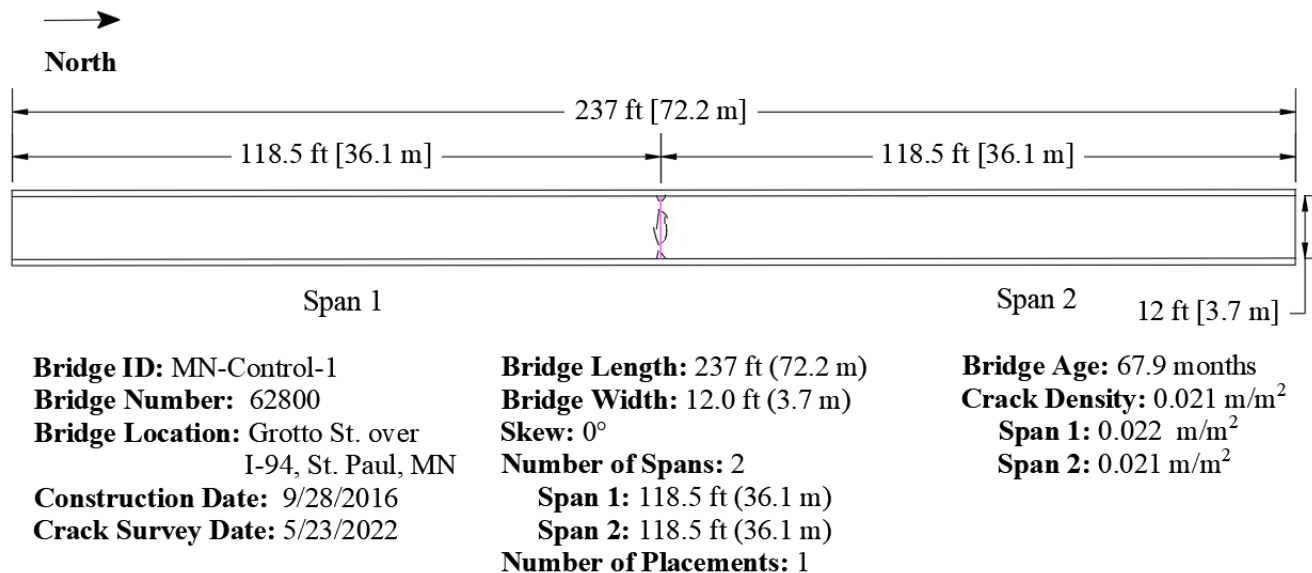
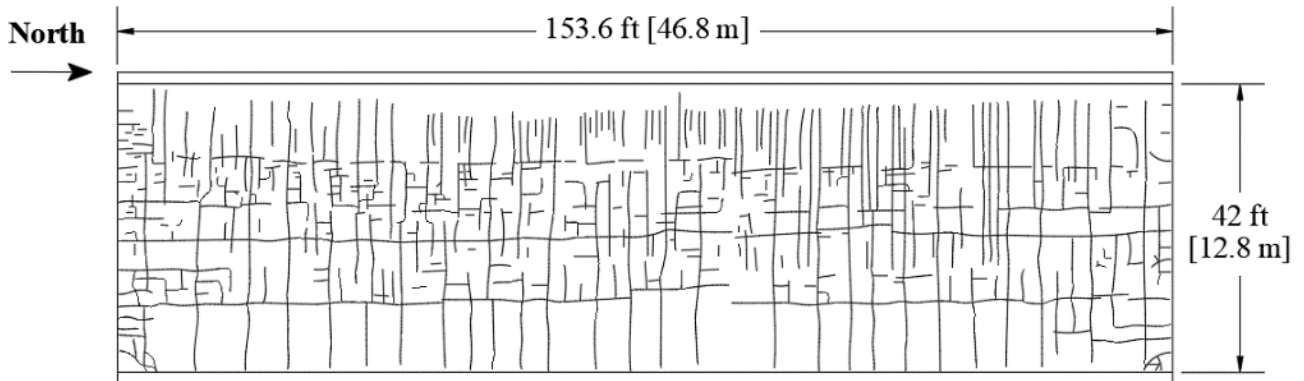

Figure 3.7: Crack Map for MN-Control-1 (Survey 6)

3.3.1.3 MN-IC-LC-HPC-2 – Deck with Overlay

MN-IC-LC-HPC-2 is a two-lane bridge that carries southbound traffic on T.H. 52 over the Little Cannon River, near Cannon Falls. In this study, MN-IC-LC-HPC-2, MN-Control-2, and MN-IC-LC-HPC-3 are the only decks constructed with overlays. The substructure was constructed on July 6, 2017, and received a 2-in. (25-mm) wearing course (overlay) on July 21 and July 24, 2017, for the right lane and shoulder, and left lane and shoulder, respectively. This deck has been surveyed three times. With a crack density of 1.429 m/m² after three years, this bridge exhibited the highest crack density in this study. Survey 1 was performed at a deck age of 10.2 months after substructure construction and 9.6 months after overlay placement, with a crack density of 0.165 m/m². The cracks were mainly in the longitudinal direction and concentrated near the north and south abutments, possibly due to restraint from the abutments in the transverse direction (Schmitt & Darwin, 1995; Miller & Darwin, 2000). In Survey 2, performed at an age of 22.9 months after substructure construction, however, longitudinal and transverse cracks were observed along the full length of the deck, with a crack density of 0.896 m/m². In Survey 3, performed at an age of 36.6 months after substructure construction, significantly longer transverse and longitudinal cracking was found throughout the deck. The transverse cracks extended across the entire surveyed width along the full length of the bridge. A number of longitudinal cracks were found mainly near

the centerline of the deck, with cracks ranging in length from 1 to 90 ft (0.3 to 27.4 m), 5 to 10 ft (1.5 to 3.1 m) apart along the bridge width. Crack widths in Survey 3 ranged from 0.009 to 0.016 in. (0.23 to 0.41 mm), with an average of 0.012 in. (0.31 mm). The high crack density on MN-IC-LC-HPC-2 is likely the result of the overlay, as has been addressed in a number of studies (Miller & Darwin, 2000; Lindquist et al., 2005; Pendergrass & Darwin, 2014; Lafikes et al., 2020). Miller and Darwin (2000) and Lindquist et al. (2005) reported greater cracking in decks with concrete overlays than for monolithic decks (one coarse) with similar characteristics. Additionally, the MN-IC-LC-HPC-2 overlay was placed in July 2017, and one possible contributor to the especially poor cracking performance of this deck could be that the restrained drying shrinkage of the overlay was exacerbated by high air temperatures. The most recent crack map (Survey 3) is shown in Figure 3.8. Additional details associated with Surveys 1 and 2 of MN-IC-LC-HPC-2 are documented by Lafikes et al. (2020).



Bridge ID: MN-IC-LC-HPC-2	Bridge Length: 153.6 ft (46.8 m)	Bridge Age: 36.6 months
Bridge Number: 25036	Bridge Width: 42 ft (12.8 m)	Crack Density: 1.429 m/m ²
Bridge Location: S.B TH 52 over Little Cannon River, MN	Skew: 0°	
	Number of Spans: 1	
	Number of Placements: 1	
Construction Date: 7/6/2017		
Crack Survey Date: 7/23/2020		

Figure 3.8: Crack Map for MN-IC-LC-HPC-2 (Survey 3)

3.3.1.4 MN-Control-2 – Deck with Overlay

The associated control deck for MN-IC-LC-HPC-2, MN-Control-2, is a two-lane bridge that carries northbound traffic on T.H. 52 over the Little Cannon River, near Cannon Falls. The substructure was constructed on September 15, 2017, and received a 2-in. (25-mm) wearing course (overlay) on September 28 and September 30, 2017, for the right lane and shoulder and the left lane and shoulder, respectively. This deck has been surveyed three times. Survey 1 was performed at a deck age of 7.8 months after substructure construction and 7.3 months after overlay placement, with no observable cracks. Survey 2 was performed at a deck age of 20.6 months after substructure construction, with a crack density of 0.050 m/m². In Survey 2, the cracks were mainly concentrated near the north and south abutments. Some longitudinal cracks extended from the south abutment. One longer transverse crack, approximately 20 ft (6.1 m) in length, had developed approximately 5 ft (1.5 m) from the south abutment. Crack widths in Survey 2 ranged from 0.003 to 0.007 in. (0.08 to 0.18 mm), with an average of 0.005 in. (0.13 mm). Survey 3 was performed at a deck age of 34.3 months after substructure construction, with a crack density of 0.539 m/m². The crack density observed in Survey 3 was much higher than the value of 0.050 m/m² measured in Survey 2, but not unexpected since it often takes three years to establish the cracking performance of bridge decks – even decks that perform well during the first two years (Lindquist et al., 2008; Yuan et al., 2011; Pendergrass & Darwin, 2014). Longer transverse cracking was found throughout the deck. The transverse cracks extended across the entire surveyed width near the south end. A longer longitudinal crack, approximately 90 ft (27.4 m) in length, had developed from the south abutment near the centerline. Crack widths in Survey 3 ranged from 0.004 to 0.020 in. (0.10 to 0.51 mm), with an average of 0.011 in. (0.28 mm). One possible reason for the better cracking performance of this deck compared to its pair (MN-IC-LC-HPC-2) could be the placement of its overlay in a milder environmental condition. The MN-Control-2 overlay was placed in September when the cooler ambient temperatures would have helped reduce rapid drying shrinkage, exacerbated by higher temperatures for the MN-IC-LC-HPC-2 overlay placed in July. Due to the placement of overlay on MN-Control-2, the effects of fibers in the substructure could not be investigated. The most recent crack map (Survey 3) is shown in Figure 3.9. Additional details associated with Surveys 1 and 2 of MN-Control-2 are documented by Lafikes et al. (2020).

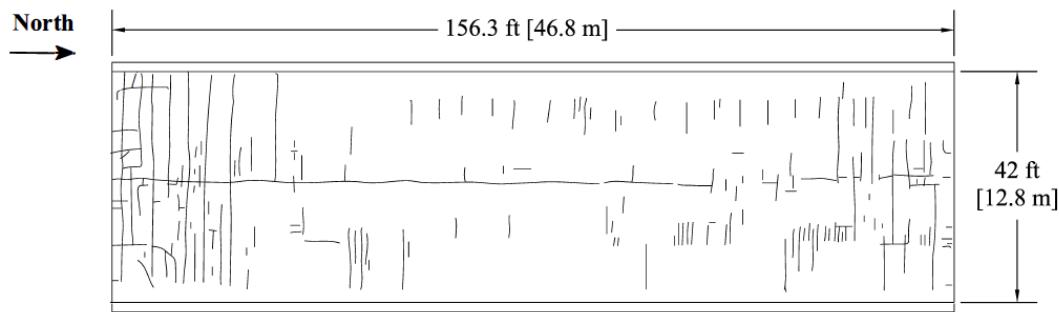

Bridge ID: MN-Control-2	Bridge Length: 153.6 ft (46.8 m)	Bridge Age: 34.3 months
Bridge Number: 25032	Bridge Width: 42 ft (12.8 m)	Crack Density: 0.539 m/m ²
Bridge Location: S.B TH 52 over Little Cannon River, MN	Skew: 0°	Number of Spans: 1
Construction Date: 9/15/2017	Number of Placements: 1	
Crack Survey Date: 7/23/2020		

Figure 3.9: Crack Map for MN-Control-2 (Survey 3)

3.3.1.5 MN-IC-LC-HPC-3 – Deck with Overlay

MN-IC-LC-HPC-3 is a two-way bridge that carries traffic on T.H. 58 over T.H. 52 in Zumbrota. The subdeck was constructed in one placement on June 29, 2017. The deck received a 2-in. (25-mm) wearing course (overlay) on September 7 and September 9, 2017. The 34-ft (10.4 m) wide roadway of the deck has been surveyed three times. Survey 1 was performed at a deck age of 10.4 months after substructure construction and 8.1 months after overlay placement, with no observable cracks. Survey 2 was performed at a deck age of 23.2 months after substructure construction, with a crack density of 0.042 m/m². In Survey 2, the cracks were mainly concentrated near the north and south abutments, as well as the center pier. Some longitudinal cracks extended from each abutment, with cracks ranging in length from 1 to 2.5 ft (0.3 to 0.8 m). Transverse cracks, between 1 and 8 ft (0.3 and 2.4 m) in length, also formed within 19 ft (5.8 m) on each side of the center pier. Crack widths in Survey 2 ranged from 0.003 to 0.006 in. (0.08 to 0.15 mm), with an average of 0.004 in. (0.10 mm). Survey 3 was performed at a deck age of 36.8 months after substructure construction, with a crack density of 0.161 m/m². In Survey 3, the extent and the number of transverse and longitudinal cracks increased. Several cracks were found in the shoulder area on the west side of the deck, mainly in span 1. A number of longitudinal cracks were also formed over the piers, with cracks ranging from 1 to 7 ft (0.3 to 2.1 m) in length. Some diagonal cracks were observed near each abutment, with approximately 5 ft (1.5 m) in length. Crack widths

in Survey 3 ranged from 0.005 to 0.007 in. (0.13 to 0.18 mm), with an average of 0.006 in. (0.15 mm). With the overlay placed in September and cured in cooler ambient temperatures as well as incorporating IC water, MN-IC-LC-HPC-3 exhibited the lowest crack density at a given deck age for the overlay decks in this study. The most recent crack map (Survey 3) is shown in Figure 3.10. Additional details associated with Surveys 1 and 2 of MN-IC-LC-HPC-3 are documented by Lafikes et al. (2020).

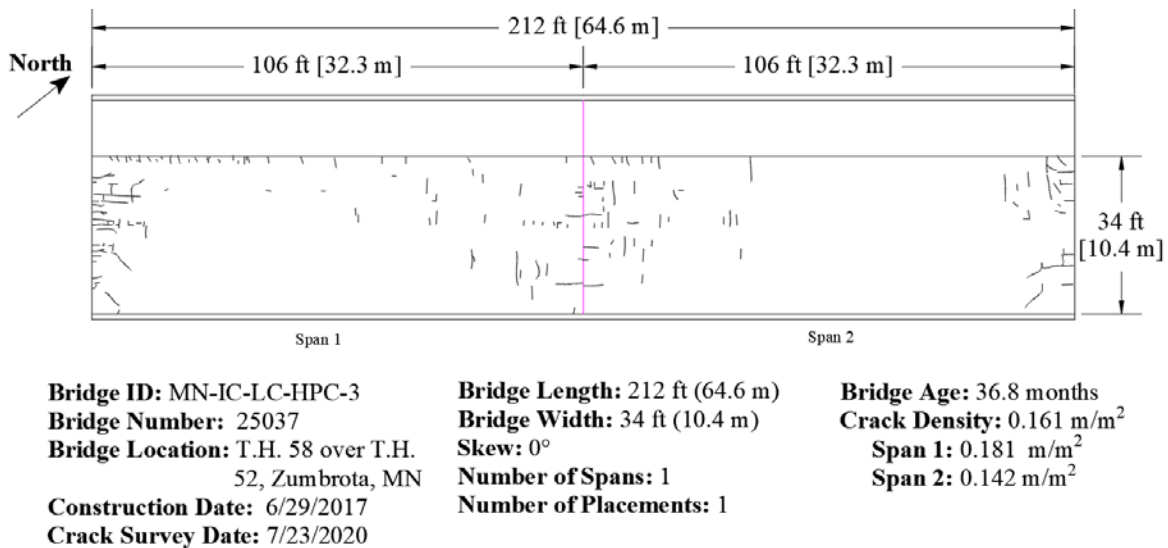

Figure 3.10: Crack Map for MN-IC-LC-HPC-3 (Survey 3)

3.3.1.6 MN-IC-LC-HPC-4

MN-IC-LC-HPC-4 is a two-way bridge that carries traffic on 38th St. over I-35W in Minneapolis. The deck was constructed in one placement on May 15, 2018. The 36-ft (11-m) wide roadway has been surveyed three times and exhibited a crack density equal to 0.046 m/m² at a deck age of 48.3 months. Cracking consists of a large number of small cracks distributed over the deck with a small increase in short longitudinal and transverse cracks (crack lengths below 1 ft [305 mm]) observed in these regions at an age of 48.7 months, as described in Section 2.4.6. Survey 1 was performed at a deck age of 16.0 months, with a crack density of 0.005 m/m². In Survey 1, the majority of cracks were in the transverse direction and were distributed over spans 1 and 3 of the deck. A few longitudinal cracks were located near the middle of spans 2 and 3. No cracking

was observed in span 4. The bridge deck was not surveyed in the second year after the construction. Surveys 2 and 3 were performed at the ages of 37.0 and 48.3 months, respectively. The overall crack density did not noticeably change in Surveys 2 and 3, with values of 0.045 and 0.046 m/m², respectively. The majority of cracks in Surveys 2 and 3 were short longitudinal and transverse cracks (crack lengths below 1 ft. [305 mm]) distributed over the entire deck area with crack widths ranging from 0.002 to 0.007 in. (0.05 to 0.18 mm) and an average of 0.003 in. (0.08 mm). One larger transverse crack was also observed in span 3 with a crack length of 2 ft (0.6 m). Some surface damage was observed due to poor tining of the deck, as reported by Lafikes et al. (2020). The most recent crack maps (Surveys 2 and 3) are shown in Figures 3.11 and 3.12. Additional details associated with Survey 1 of MN-IC-LC-HPC-4 are documented by Lafikes et al. (2020).

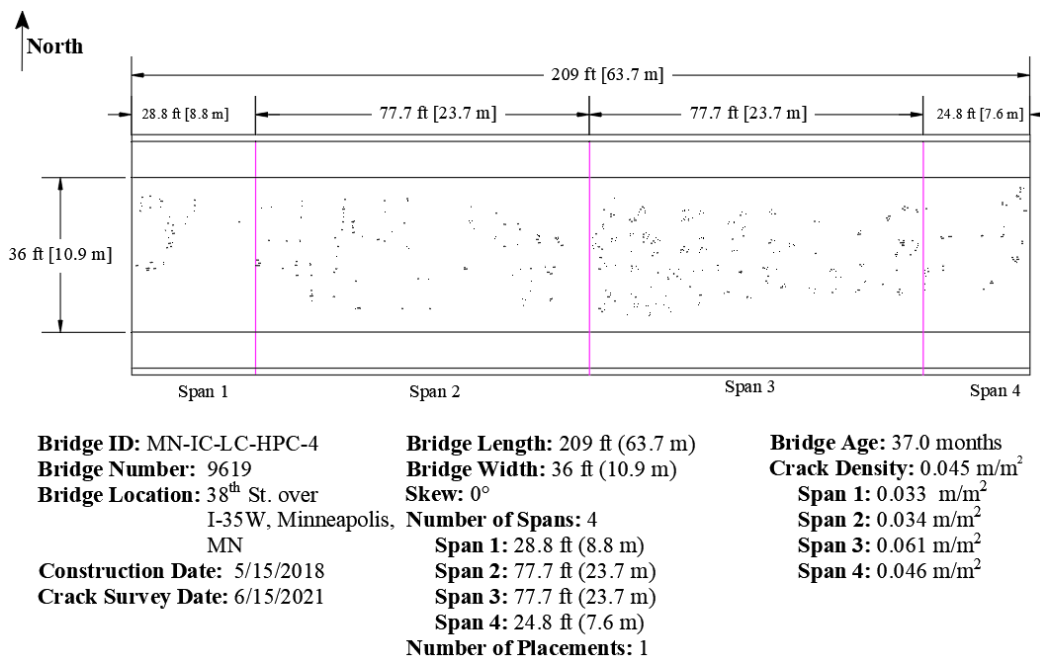

Figure 3.11: Crack Map for MN-IC-LC-HPC-4 (Survey 2)

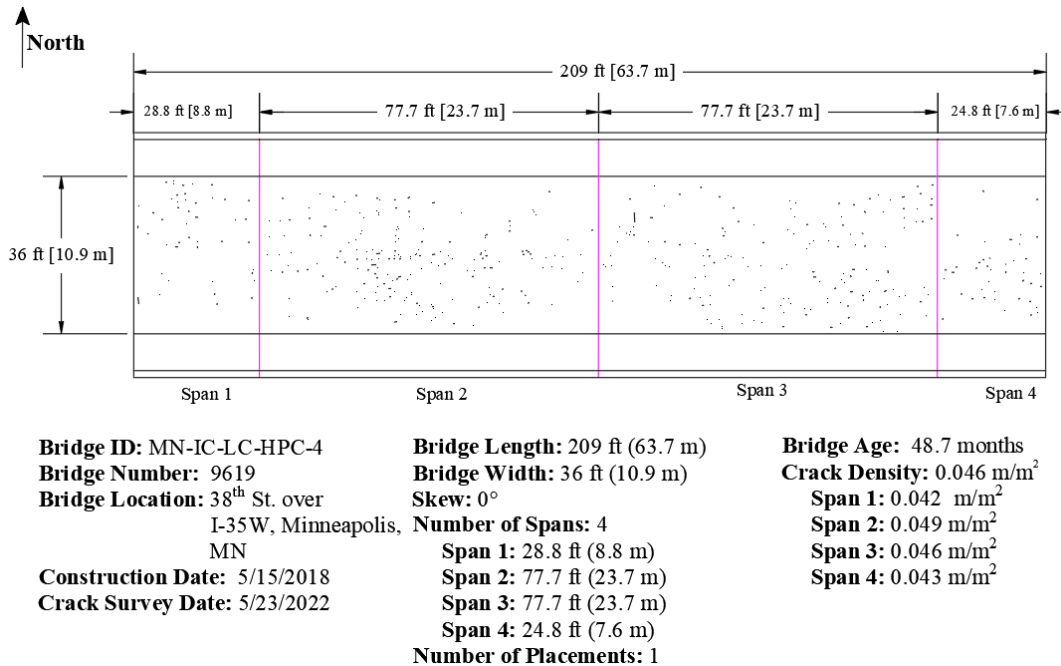

Figure 3.12: Crack Map for MN-IC-LC-HPC-4 (Survey 3)

3.3.1.7 MN-IC-LC-HPC-5

MN-IC-LC-HPC-5 is a pedestrian bridge located at 40th St. over I-35W in Minneapolis. The deck was constructed in one placement on July 23, 2019. This deck has been surveyed three times since 2019 and has exhibited the highest crack densities at a given age of the pedestrian bridge decks (MN-IC-LC-HPC-1 and MN-Control-1) constructed in this study. Survey 1 was performed at a deck age of 11.0 months, with a crack density of 0.009 m/m². In Survey 1, only a small number of diagonal cracks were observed on either side of the contraction joint over the center pier, with crack lengths ranging from 1.5 to 2 ft (0.5 to 0.6 m). Survey 2 was performed at a deck age of 22.7 months, with a crack density of 0.091 m/m², an increase from the 0.009 m/m² density observed during Survey 1. Some long transverse cracks were observed over the entire deck, mainly with lengths of 3 to 6 ft (0.9 to 1.8 m). Crack widths in Survey 2 ranged from 0.004 to 0.007 in. (0.10 to 0.18 mm), with an average of 0.006 in. (0.152 mm). Survey 3 was conducted at a deck age of 34.1 months and had transverse cracks that extended almost one-third of the deck width, with a crack density of 0.153 m/m². Crack widths in Survey 3 ranged from 0.010 to 0.050 in. (0.25 to 1.27 mm), with an average of 0.019 in. (0.48 mm). The crack maps associated with Surveys 1 to 3 are shown in Figures 3.13 to 3.15, respectively. As discussed in Section 2.4.7, the

cracking performance of the deck may have been affected due to inadequate consolidation, as observed during the construction. Construction personnel were observed walking through areas that had been previously vibrated, resulting in deconsolidation of the concrete. As demonstrated in multiple decks in Kansas, inadequate consolidation can result in a higher crack density (McLeod et al., 2009; Khajehdehi & Darwin, 2018).

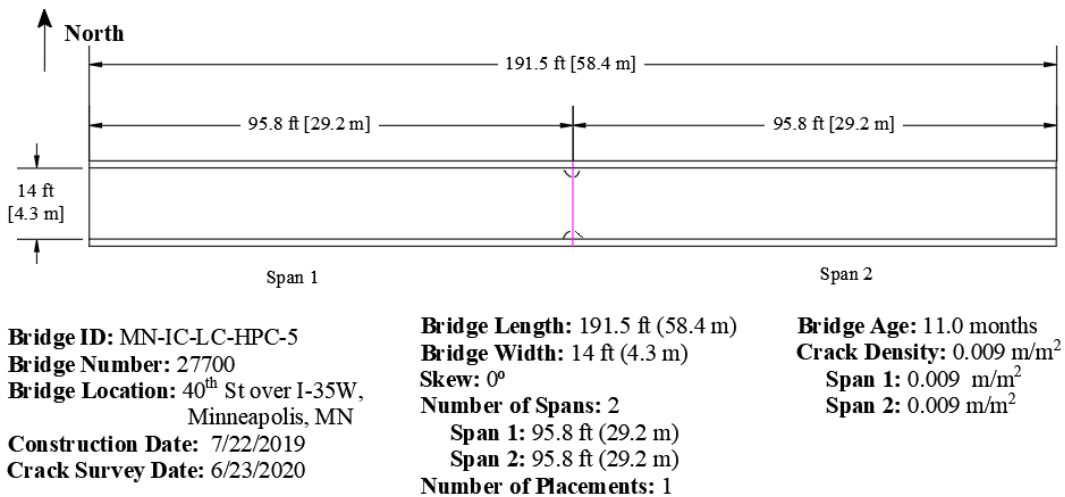

Figure 3.13: Crack Map for MN-IC-LC-HPC-5 (Survey 1)

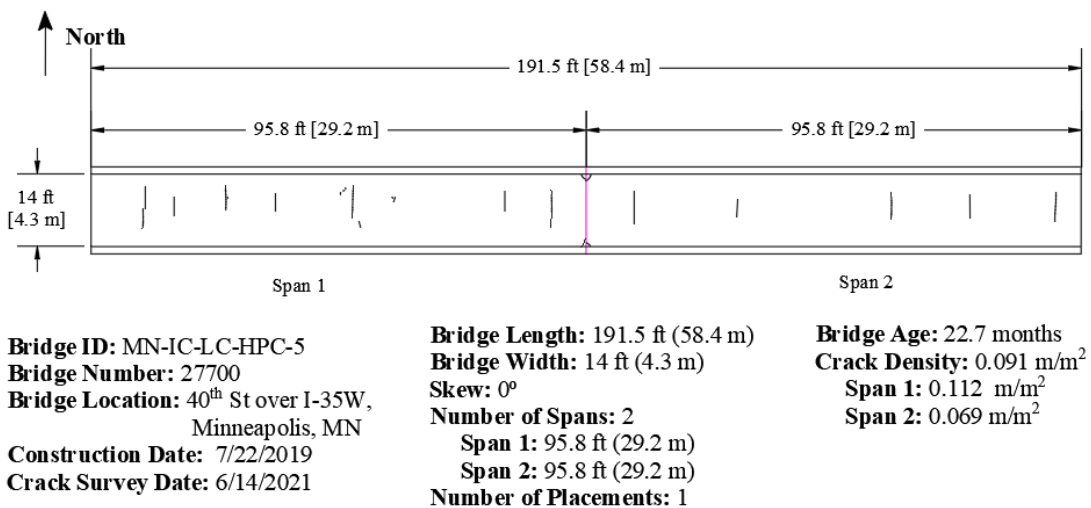

Figure 3.14: Crack Map for MN-IC-LC-HPC-5 (Survey 2)

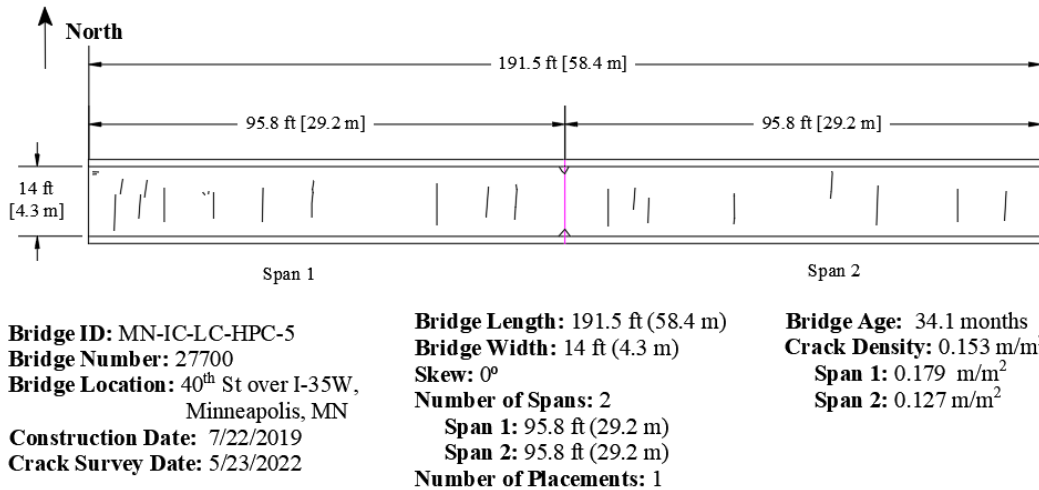

Figure 3.15: Crack Map for MN-IC-LC-HPC-5 (Survey 3)

During Surveys 2 and 3, scaling was also observed at multiple locations on the surface of the deck (Figure 3.16). As discussed in Section 2.4.7, significant bleed water was observed on the deck during the construction, and the surface damage is possibly the result of the contractor over-fining the deck in an attempt to remove excess bleed water. In the process, much of that bleed water was worked back into the surface, resulting in a thin paste layer with a high w/cm . Additionally, the bridge deck had two tests for air content that were below the minimum specified value of the specifications (6.5%), although retests showed slightly higher values and concrete placement continued. MN-IC-LC-HPC-5 clearly indicates that with poor construction practices, even decks with low paste content and internal curing water can exhibit increased cracking and the possibility of other durability problems.

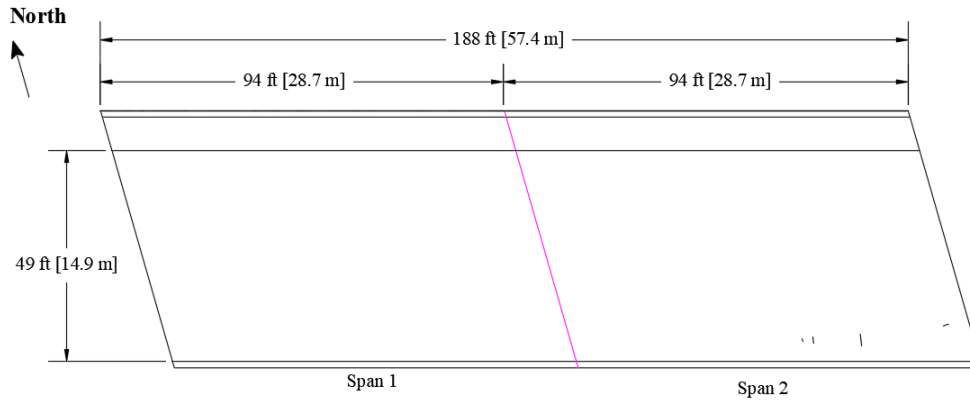

Figure 3.16: Scaling Damage of MN-IC-LC-HPC-5 (a) Near Barriers; (b) A Typical Section for the Remainder of the Deck

3.3.1.8 MN-IC-LC-HPC-6

MN-IC-LC-HPC-6 is a two-lane bridge that carries traffic on C.S.A.H. 7 over I-35W near Pine City. The deck was constructed in one placement on September 19, 2019. This deck has been surveyed three times since 2019, exhibiting very low crack densities (below 0.02 m/m^2). The 49-ft (14.9-m) roadway, but not the sidewalk, has been surveyed. Survey 1 was performed at a deck age of 10.8 months with a crack density of 0.002 m/m^2 . In Survey 1, the majority of cracks were randomly positioned, distributed only over span 2. No cracks were observed in span 1. Crack widths in Survey 1 ranged from 0.004 to 0.007 in. (0.10 to 0.18 mm), with an average of 0.005 in. (0.13 mm). Survey 2 was performed at a deck age of 20.9 months with a crack density of 0.003 m/m^2 . In Survey 2, some randomly positioned cracks were observed distributed over spans 1 and 2. One short crack was observed near the west end of the deck (crack length below 1 ft [305 mm]). One diagonal crack was extended from the central pier approximately 3.5 ft (1.1 m) in length. Survey 3 was performed at a deck age of 32.2 months with a crack density of 0.011 m/m^2 . Both the number and the length of cracks increased compared to Survey 2, and similar to previous years, the cracks were short and scattered at discrete locations on the deck. A number of longitudinal cracks were found, mostly on the south side of span 1, with crack lengths ranging from 1 to 6 ft (0.3 to 1.8 m). Crack widths in Survey 3 ranged from 0.003 to 0.016 in. (0.08 to 0.41 mm), with

an average of 0.010 in. (0.25 mm). The crack maps associated with Surveys 1 to 3 are shown in Figures 3.17 to 3.19, respectively.



Bridge ID: MN-IC-LC-HPC-6	Bridge Length: 188 ft (57.4 m)	Bridge Age: 10.8 months
Bridge Number: 58826	Bridge Width: 49 ft (14.9 m)	Crack Density: 0.002 m/m ²
Bridge Location: T.H.35 Under C.S.A.H 7, Pine City, MN	Skew: 16° 2' 30"	Span 1: 0.000 m/m ²
Construction Date: 9/19/2019	Number of Spans: 2	Span 2: 0.005 m/m ²
Crack Survey Date: 8/13/2020	Span 1: 94 ft (28.7 m)	
	Span 2: 94 ft (28.7 m)	
	Number of Placements: 1	

Figure 3.17: Crack Map for MN-IC-LC-HPC-6 (Survey 1)

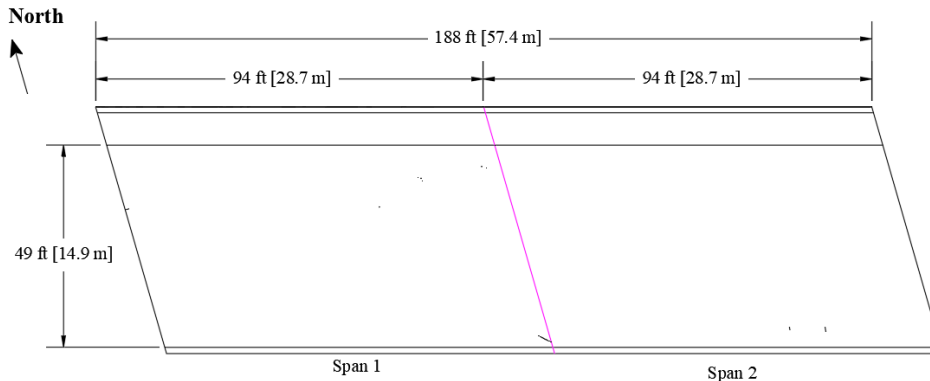

Bridge ID: MN-IC-LC-HPC-6	Bridge Length: 188 ft (57.4 m)	Bridge Age: 20.9 months
Bridge Number: 58826	Bridge Width: 49 ft (14.9 m)	Crack Density: 0.003 m/m ²
Bridge Location: T.H.35 Under C.S.A.H 7, Pine City, MN	Skew: 16° 2' 30"	Span 1: 0.004 m/m ²
Construction Date: 9/19/2019	Number of Spans: 2	Span 2: 0.001 m/m ²
Crack Survey Date: 6/16/2021	Span 1: 94 ft (28.7 m)	
	Span 2: 94 ft (28.7 m)	
	Number of Placements: 1	

Figure 3.18: Crack Map for MN-IC-LC-HPC-6 (Survey 2)

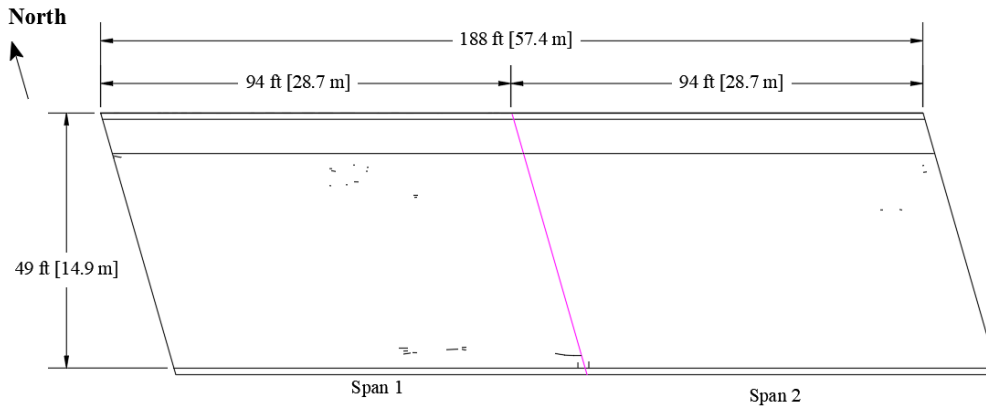

Bridge ID: MN-IC-LC-HPC-6	Bridge Length: 188 ft (57.4 m)	Bridge Age: 32.2 months
Bridge Number: 58826	Bridge Width: 49 ft (14.9 m)	Crack Density: 0.011 m/m ²
Bridge Location: T.H.35 Under C.S.A.H 7, Pine City, MN	Skew: 16° 2' 30"	Span 1: 0.017 m/m ²
Construction Date: 9/19/2019	Number of Spans: 2	Span 2: 0.004 m/m ²
Crack Survey Date: 5/24/2022	Span 1: 94 ft (28.7 m)	
	Span 2: 94 ft (28.7 m)	
	Number of Placements: 1	

Figure 3.19: Crack Map for MN-IC-LC-HPC-6 (Survey 3)

As with MN-IC-LC-HPC-4, MN-IC-LC-HPC-6 showed some surface damage during the crack surveys, as shown in Figure 3.20. As discussed in Section 2.4.8, the deck was heavily tined immediately after finishing and before application of the curing compound, resulting in varying groove widths and depths on the deck surface. During Surveys 2 and 3, some scaling was also observed near the barriers. One possible explanation could be that although the deck had an average air content of 7.9%, it was constructed in late September (and therefore cured at cold ambient temperatures), which increased the potential of concrete durability problems.

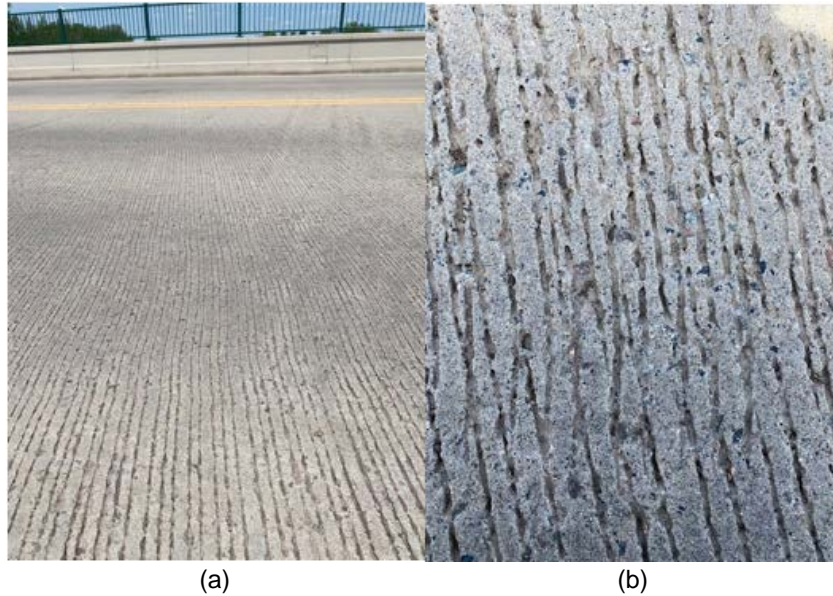

Figure 3.20: Poor Tining of MN-IC-LC-HPC-6 (a) An Overview; (b) A Close-Up View

3.3.1.9 MN-IC-LC-HPC-7

MN-IC-LC-HPC-7 is a two-way bridge that carries traffic on Dale St. over I-35 in St. Paul. The deck was constructed in two placements; each placement covered half of the total deck width, dividing the deck into east and west sides from the centerline of the roadway. The first placement (MN-IC-LC-HPC-7-P1) was constructed on June 24, 2020. The second placement (MN-IC-LC-HPC-7-P2) was completed on September 22, 2020. The crack surveys covered only the sidewalks (incorporating IC water) and a portion of the roadway due to restrictions imposed by traffic control. For Survey 1, only one lane and the two sidewalks were surveyed. Survey 1 was performed at a deck age of 11.7 months for Placement 1 and 8.8 months for Placement 2. In Survey 1, the deck exhibited a low crack density (below 0.050 m/m^2), with cracks observed mainly on the sidewalks near the center pier. One single transverse crack was observed within 25 ft from the south end, with a length of about 5 ft (1.5 m). Crack widths in Survey 1 ranged from 0.002 to 0.006 in. (0.05 to 0.15 mm), with an average of 0.004 in. (0.10 mm). For Survey 2, the two sidewalks (incorporating IC water) but only one lane and a shoulder were surveyed. Survey 2 was performed at a deck age of 23.0 months for Placement 1 and 20.0 months for Placement 2. A number of diagonal cracks were observed on either side of the piers on the sidewalks. Some randomly oriented cracks were found at all spans. Two longitudinal cracks were observed near the north end,

with approximately 7 ft (2.1 m) in length. Some short and narrow cracks (with crack lengths below 6 in. [152.4 mm]) were observed mostly on the roadway within 5 ft (1.5 m) from the barrier, possibly due to insufficient consolidation, observed in some locations during the construction. The crack densities for the entire deck (both placements) were 0.016 and 0.031 in Surveys 1 and 2, respectively, 0.018 and 0.037 for Placement 1; and 0.014 and 0.024 m/m² for Placement 2. Crack widths in Survey 2 ranged from 0.003 to 0.025 in. (0.08 to 0.64 mm), with an average of 0.007 in. (0.18 mm). The crack maps associated with Surveys 1 and 2 are shown in Figures 3.21 and 3.22, respectively.

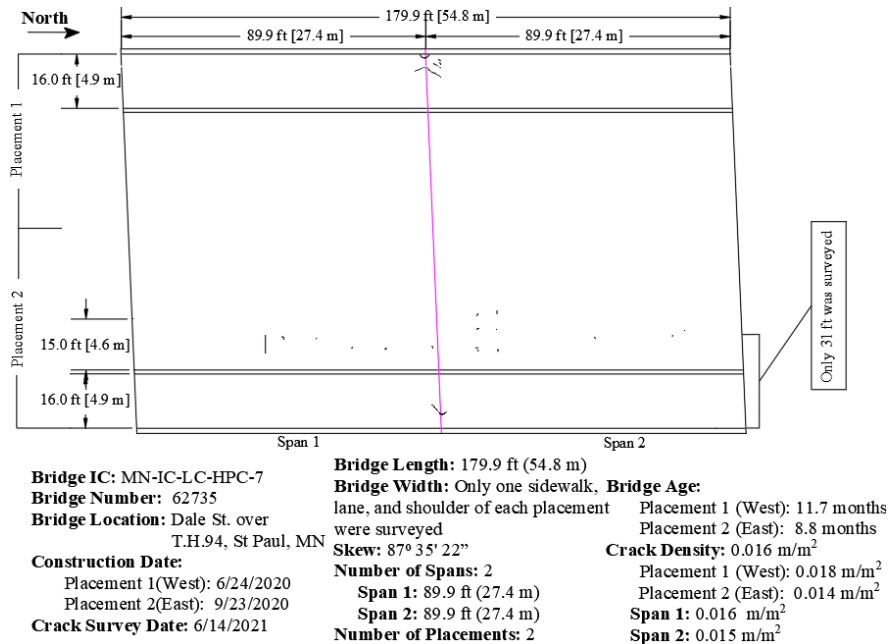

Figure 3.21: Crack Map for MN-IC-LC-HPC-7 (Survey 1)

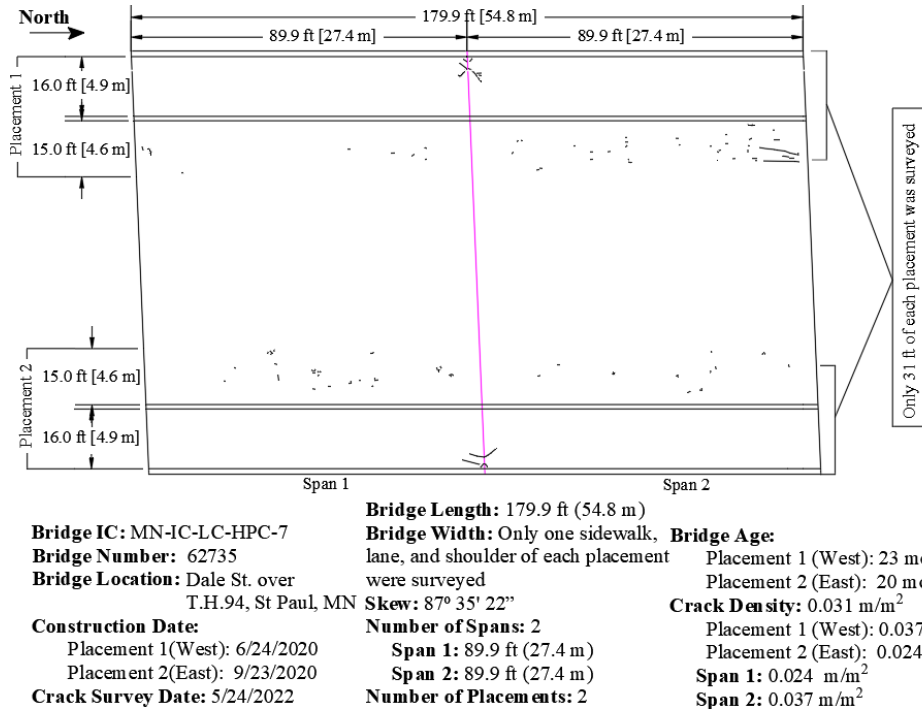

Figure 3.22: Crack Map for MN-IC-LC-HPC-7 (Survey 2)

3.3.1.10 MN-IC-LC-HPC-8

MN-IC-LC-HPC-8 is a two-lane bridge that carries traffic on C.S.A.H. 12 over I-90 in Winona. The deck was constructed in one placement on August 20, 2020. As discussed in Chapter 4, MN-IC-LC-HPC-8 is another example of a bridge deck constructed with poor construction practices. This deck has been surveyed two times, with Survey 2 exhibiting one of the highest crack densities for an IC deck placed without overlay in this study. Survey 1 was performed at a deck age of 9.9 months with a crack density of 0.013 m/m². In Survey 1, the majority of cracks were longitudinal cracks extending from both abutments. Some transverse cracks, approximately 3 ft (0.9 m) in length, had developed near the center pier of the bridge. Crack widths in Survey 1 ranged from 0.004 to 0.025 in. (0.10 to 0.64 mm), with an average of 0.009 in. (0.23 mm). Due to high crack density, in Survey 2 only one lane and a shoulder of MN-IC-LC-HPC-8 were surveyed (18 ft [5.5 m] of the west side). Survey 2 was performed at a deck age of 21.2 months with a crack density of 0.671 m/m², considerably higher than Survey 1. As shown in Figure 3.23 for Survey 2, a notable amount of map cracking was found, especially near the center pier and in the middle of Spans 1 and 2. The crack maps associated with Surveys 1 and 2 are shown in Figures 3.24 and

3.25, respectively. As discussed in Section 3.2.1, map cracking is not totally clear in Figure 3.24 due to the scale of the image. As discussed in Section 2.4.10, probable cause of the poor cracking performance of decks was the non-uniform distribution of curing compound applied during construction, tied with the long delay in applying the wet burlap, leading to plastic shrinkage. It was also indicated by MnDOT personnel that the cracking may have resulted from increased traffic from heavy vehicles from a truck parking lot located 0.3 miles (0.482 km) south of the bridge, which could have increased tensile stresses in the deck. While most cracks were longitudinal and distributed over the entire deck area, several larger longitudinal and transverse cracks were found near the abutments and center pier, respectively. Crack widths in Survey 2 ranged from 0.003 to 0.060 in. (0.08 to 1.52 mm), with an average of 0.018 in. (0.46 mm).



Figure 3.23: Map Cracking on a Typical Section of MN-IC-LC-HPC-8

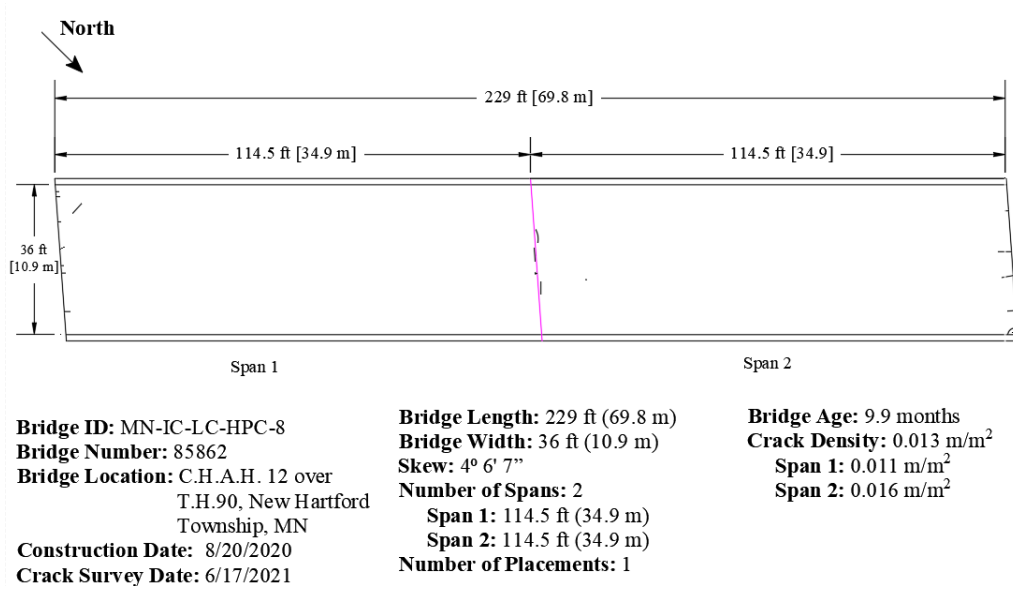

Figure 3.24: Crack Map for MN-IC-LC-HPC-8 (Survey 1)

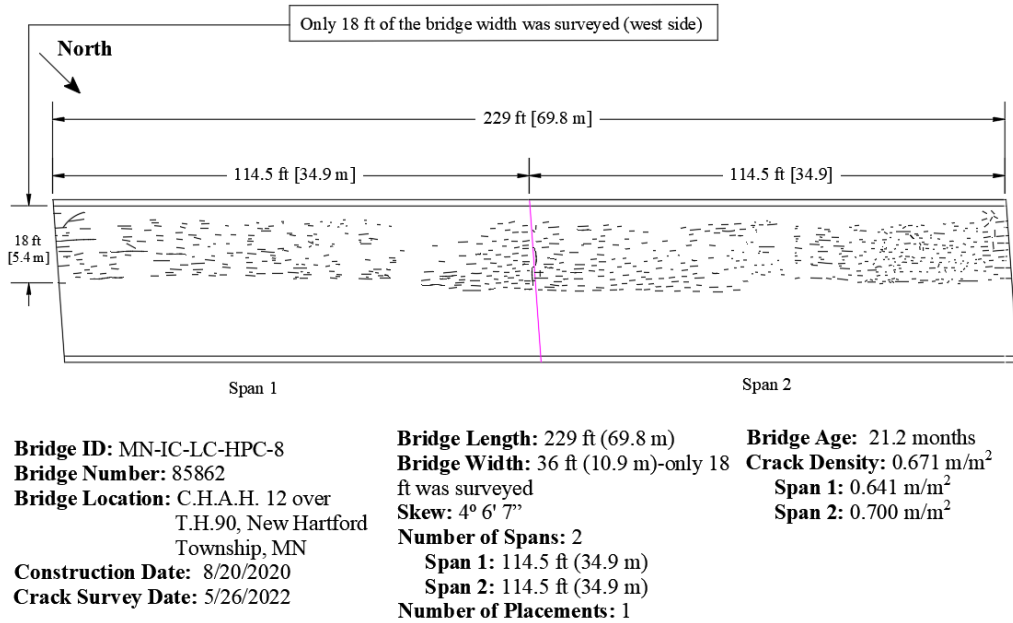

Figure 3.25: Crack Map for MN-IC-LC-HPC-8 (Survey 2)

3.3.1.11 MN-IC-LC-HPC-9

MN-IC-LC-HPC-9 carries eastbound traffic on I-90 over Dakota Valley in Winona. The deck was constructed in one placement on September 4, 2020. The concrete supplier and the contractor were the same as MN-IC-LC-HPC-8 and, as with MN-IC-LC-HPC-8, MN-IC-LC-

HPC-9, is another example of a bridge deck constructed with poor construction practices. This deck has been surveyed two times, with Survey 2 exhibiting the highest crack densities for an IC deck placed without overlay in this study. Survey 1 was performed at a deck age of 9.5 months with a crack density of 0.004 m/m^2 . In Survey 1, the majority of cracks were transverse cracks within 5 ft (1.5 m) of the abutments. No cracks were observed in span 2. Crack widths in Survey 1 ranged from 0.002 to 0.004 in. (0.05 to 0.10 mm), with an average of 0.003 in. (0.08 mm). Due to high crack density, in Survey 2, only one lane and a shoulder of MN-IC-LC-HPC-9 were surveyed (20 ft [6.1 m] of the south side). Survey 2 was performed at a deck age of 20.6 months with a crack density of 0.788 m/m^2 , considerably higher than Survey 1. As shown in Figure 3.26 for Survey 2, a notable amount of map cracking was found, especially in the middle of spans 1 and 3. The crack maps associated with Surveys 1 and 2 are shown in Figures 3.27 and 3.28, respectively. Again, as discussed in Section 3.2.1, map cracking is not totally clear in Figure 3.28 due to the scale of the image. The majority of cracks were longitudinal (lengths of 2 ft [0.6 m] or less) distributed over the entire deck area. The underside of the deck, however, did not appear to reflect these cracks, as shown in Figure 3.29. Some longitudinal cracks extended from the east abutment. Two longer longitudinal cracks, approximately 9 ft (2.7 m) in length, had developed from the pier between spans 2 and 3. A number of transverse cracks were observed within 15 ft (4.6 m) of the west abutment and within 5 ft (1.5 m) of the east abutment. Crack widths in Survey 2 ranged from 0.007 to 0.025 in. (0.18 to 0.64 mm), with an average of 0.011 in. (0.28 mm). The reason for the poor cracking performance of the deck of MN-IC-LC-HPC-9 is similar to that discussed for MN-IC-LC-HPC-8, including non-uniform distribution of curing compound and a long delay in placing the wet burlap on the deck.



Figure 3.26: Map Cracking on a Typical Section of MN-IC-LC-HPC-9

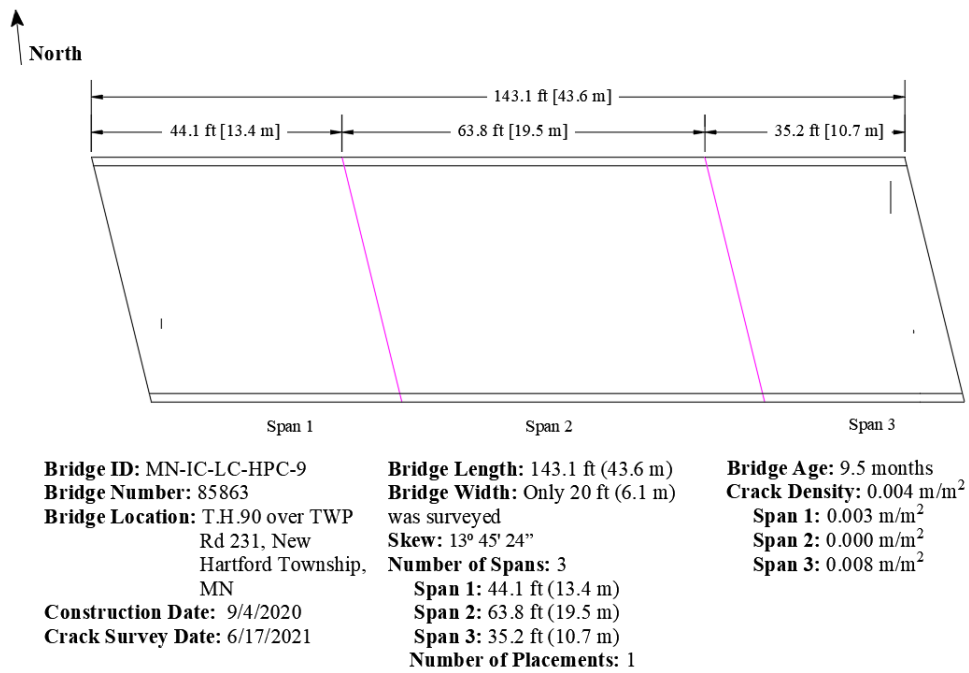

Figure 3.27: Crack Map for MN-IC-LC-HPC-9 (Survey 1)

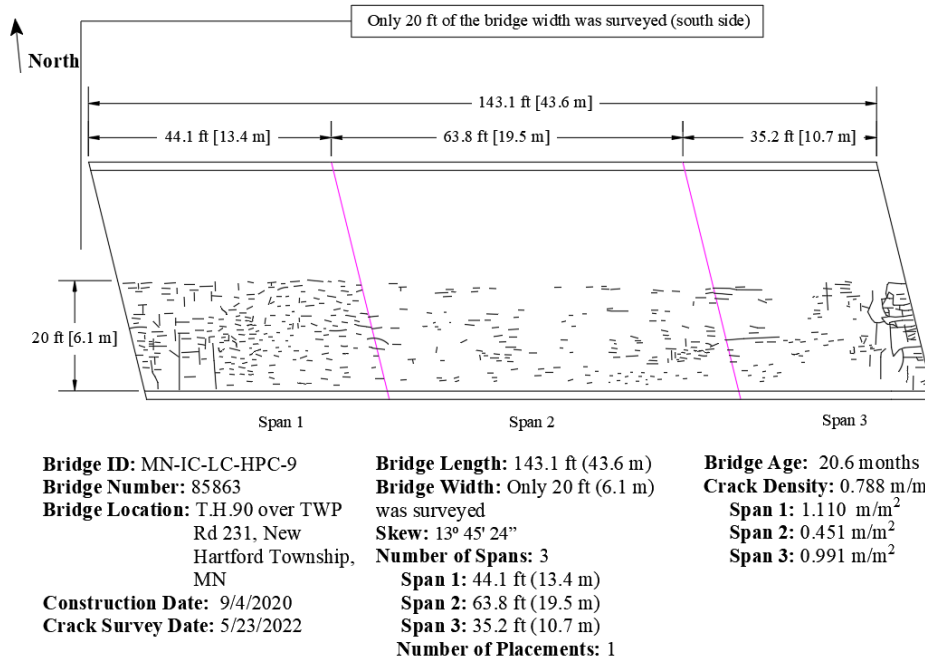

Figure 3.28: Crack Map for MN-IC-LC-HPC-9 (Survey 2)



Figure 3.29: Underside of MN-IC-LC-HPC-9 Bridge Deck

3.3.2 Kansas Bridge Deck Crack Survey Results

Four IC-LC-HPC bridge decks have, to date, been constructed in Kansas, one each in 2019, 2020, 2021, and 2023. Only the first three are described in this report. The fourth deck, constructed

in June 2023, will be surveyed with results reported to KDOT in 2024. Crack surveys on the deck constructed in 2019, KS-IC-LC-HPC-1, were performed in July 2021 (approximately 20 months after construction) and June 2022 (approximately 31 months after construction). Crack surveys on the deck constructed in 2020 (KS-IC-LC-HPC-2), which involved two placements, were performed in July 2021 (approximately 8.5 months for both placements) and June 2022 (approximately 19.5 months for both placements). A crack survey on the deck constructed in 2021, KS-IC-LC-HPC-3, was performed in June 2022 (approximately 9 months after construction).

3.3.2.1 KS-IC-LC-HPC-1

KS-IC-LC-HPC-1 is a two-lane bridge that carries traffic on Sunflower Rd. over I-35 in Edgerton, Kansas, with a skew of $18^{\circ} 32'$. The deck was constructed in one placement on November 26, 2019. This deck has been surveyed three times and exhibited a crack density of 0.039 m/m^2 at a deck age of 45.8 months. The deck was not surveyed in the first year after the construction. Survey 1 was performed at a deck age of 19.8 months, with a crack density of 0.015 m/m^2 . In Survey 1, the majority of cracks were located on either side of the piers, perpendicular to the end of the deck. Some cracks were also observed perpendicular to the skew of the deck at both abutments. Crack widths in Survey 1 ranged from 0.003 to 0.025 in. (0.08 to 0.64 mm), with an average of 0.015 in. (0.38 mm). Survey 2 was performed at a deck age of 30.9 months, with a crack density of 0.019 m/m^2 . In Survey 2, the number and length of cracks increased compared to Survey 1, mostly observed near the same locations. Crack widths in Survey 2 ranged from 0.013 to 0.020 in. (0.33 to 0.51 mm), with an average of 0.016 in. (0.41 mm). Survey 3 was performed at a deck age of 45.8 months, with a crack density of 0.039 m/m^2 . In Survey 3, the number and length of cracks again increased, with more cracks appearing in the two spans. Crack widths in Survey 3 ranged from 0.002 to 0.025 in. (0.05 to 0.64 mm), with an average of 0.009 in. (0.23 mm). The reduction in average crack width can be attributed to the newer cracks appearing on the deck. The crack maps associated with Surveys 1, 2, and 3 are shown in Figures 3.30, 3.31, and 3.32 respectively. During the crack surveys, some scaling was also observed, mainly near the shoulders, as shown in Figure 3.33. The scaling may have occurred because the concrete had air contents as low as 5.5% and on at least one occasion the fogging system in use by the contractor caused water

to accumulate on the surface of the plastic concrete, as discussed in Section 2.7.1. Overall, air contents ranged from 5.5 to 7.6%, with an average of 6.3%, which compares with the LC-HPC specifications that require individual air content reading to be between 6.5 and 9.5%. Lafikes et al. (2020) recommended requiring air contents above 7% to improve freeze-thaw durability and scaling resistance of concrete mixtures incorporating IC water. KS-IC-LC-HPC-1 (Sunflower Rd.) bridge deck was constructed in late November (and therefore cured in cold ambient temperatures). Furthermore, on the day of placement the air temperature ranged from 38 to 49 °F (3 to 9 °C) with an average of 43 °F (6 °C), which may have also increased the potential of concrete durability problems.

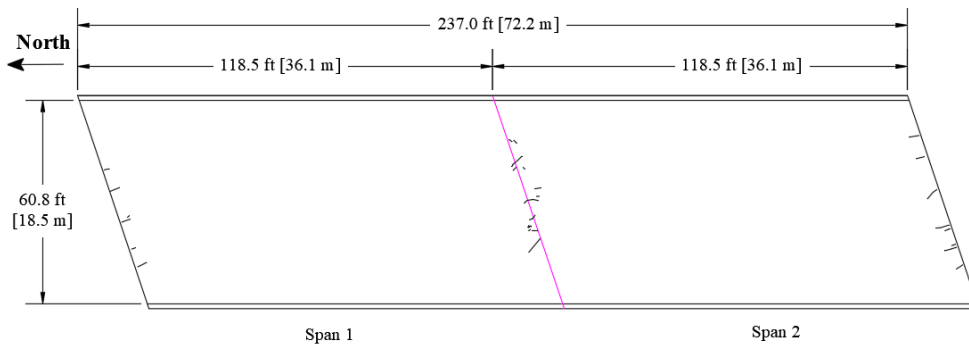

Bridge ID: KS-IC-LC-HPC-1	Bridge Length: 237.0 ft (72.2 m)	Bridge Age: 19.8 months
Bridge Number: 35-46 KA 3083-01	Bridge Width: 60.8 ft (18.5 m)	Crack Density: 0.015 m/m ²
Bridge Location: Sunflower Rd over I-35, KS	Skew: 18° 32' 0"	Span 1: 0.011 m/m ²
Construction Date: 11/26/2019	Number of Spans: 2	Span 2: 0.018 m/m ²
Crack Survey Date: 7/19/2021	Span 1: 118.5 ft (36.1 m)	
	Span 2: 118.5 ft (36.1 m)	
	Number of Placements: 1	

Figure 3.30: Crack Map for KS-IC-LC-HPC-1 (Survey 1)

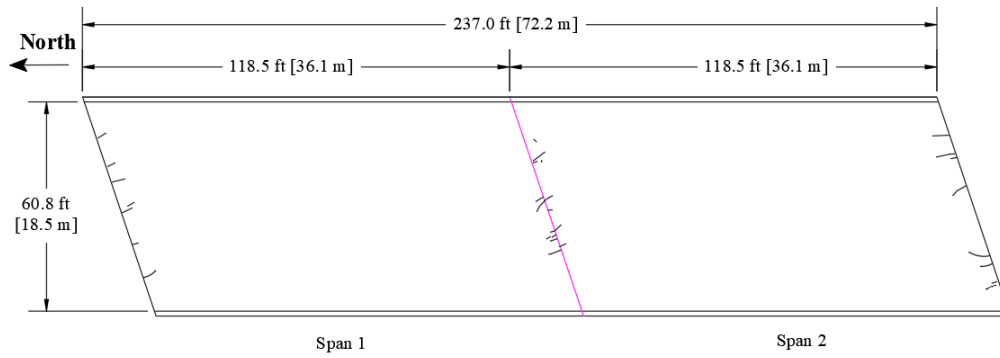

Bridge ID: KS-IC-LC-HPC-1	Bridge Length: 237.0 ft (72.2 m)	Bridge Age: 30.9 months
Bridge Number: 35-46 KA 3083-01	Bridge Width: 60.8 ft (18.5 m)	Crack Density: 0.019 m/m ²
Bridge Location: Sunflower Rd over I-35, KS	Skew: 18° 32' 0"	Span 1: 0.017 m/m ²
Construction Date: 11/26/2019	Number of Spans: 2	Span 2: 0.022 m/m ²
Crack Survey Date: 6/22/2022	Span 1: 118.5 ft (36.1 m)	
	Span 2: 118.5 ft (36.1 m)	
	Number of Placements: 1	

Figure 3.31: Crack Map for KS-IC-LC-HPC-1 (Survey 2)

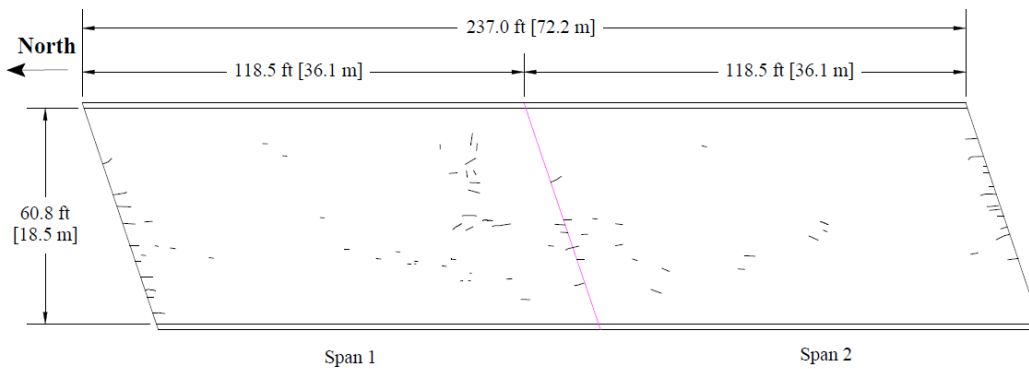

Bridge ID: KS-IC-LC-HPC-1	Bridge Length: 237.0 ft (72.2 m)	Bridge Age: 45.8 months
Bridge Number: 35-46 KA 3083-01	Bridge Width: 60.8 ft (18.5 m)	Crack Density: 0.039 m/m ²
Bridge Location: Sunflower Rd over I-35, KS	Skew: 18° 32' 0"	Span 1: 0.047 m/m ²
Construction Date: 11/26/2019	Number of Spans: 2	Span 2: 0.023 m/m ²
Crack Survey Date: 9/18/2023	Span 1: 118.5 ft (36.1 m)	
	Span 2: 118.5 ft (36.1 m)	
	Number of Placements: 1	

Figure 3.32: Crack Map for KS-IC-LC-HPC-1 (Survey 3)



Figure 3.33: Scaling Damage Observed Near the Shoulders of KS-IC-LC-HPC-1 (Survey 3)

3.3.2.2 KS-IC-LC-HPC-2

KS-IC-LC-HPC-2 is a two-lane bridge that carries traffic on Montana Road over I-35 in Ottawa, Kansas. The deck was constructed in two placements. The first placement (KS-IC-LC-HPC-2-P1) was constructed on November 3, 2020, and the second placement (KS-IC-LC-HPC-2-P2) was completed on November 11, 2020. This deck has been surveyed three times, exhibiting low crack densities in all three surveys. Survey 1 was performed at a deck age of 8.6 months for Placement 1 and 8.4 months for Placement 2, with a crack density of 0.002 m/m^2 . Some randomly oriented cracks were found in spans 1, 2, and 4. A few cracks were observed perpendicular to the south abutment. Crack widths in Survey 1 ranged from 0.002 to 0.007 in. (0.05 to 0.18 mm), with an average of 0.004 in. (0.10 mm). During Survey 1, an area with surface damage (Figure 3.34) was observed approximately 15 ft (4.6 m) from the north abutment in Placement 1, possibly caused by the direct spraying of water by the contractor (almost perpendicular to the deck surface) from a work bridge on the surface (Figure 2.57) in an attempt to wet the burlap.



Figure 3.34: Surface Damage Observed on KS-IC-LC-HPC-2-P1

Survey 2 was performed at a deck age of 19.7 months for Placement 1 and 19.4 months for Placement 2, exhibiting a low crack density of 0.003 m/m^2 . Some randomly oriented cracks were found at all spans. A few cracks were observed near the pier between spans 1 and 2, and near the pier between spans 3 and 4. Crack widths in Survey 2 ranged from 0.002 to 0.005 in. (0.05 to 0.13 mm), with an average of 0.003 in. (0.08 mm).

Survey 3 was performed at a deck age of 29.0 months for Placement 1 and 28.8 months for Placement 2, and again exhibited very low crack densities (0.006 m/m^2). A few randomly oriented cracks were found at all spans. Crack widths in Survey 3 ranged from 0.002 to 0.020 in. (0.05 to 0.51 mm), with an average of 0.007 in. (0.18 mm). The crack maps associated with Surveys 1, 2, and 3 are shown in Figures 3.35, 3.36, and 3.37, respectively.

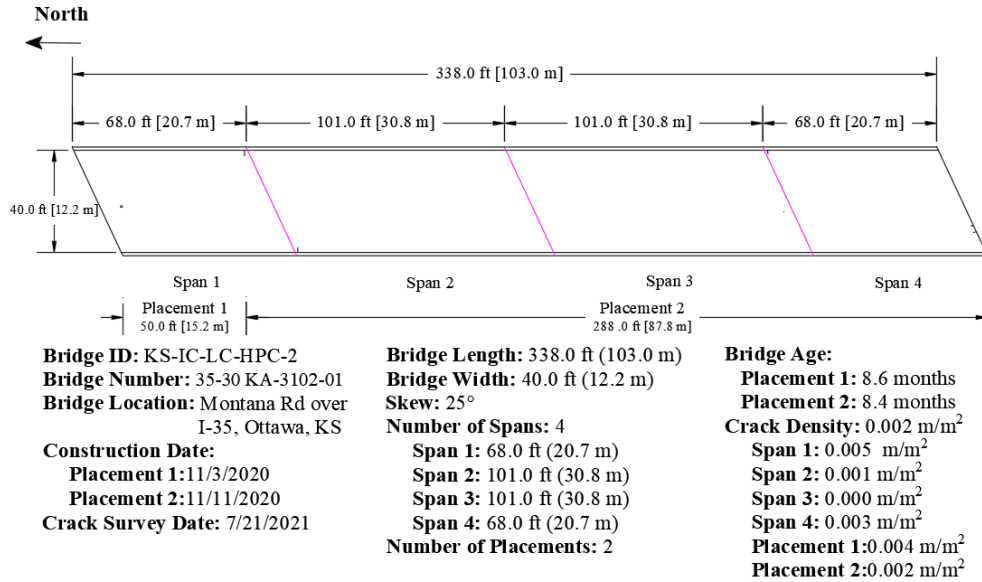

Figure 3.35: Crack Map for KS-IC-LC-HPC-2 (Survey 1)

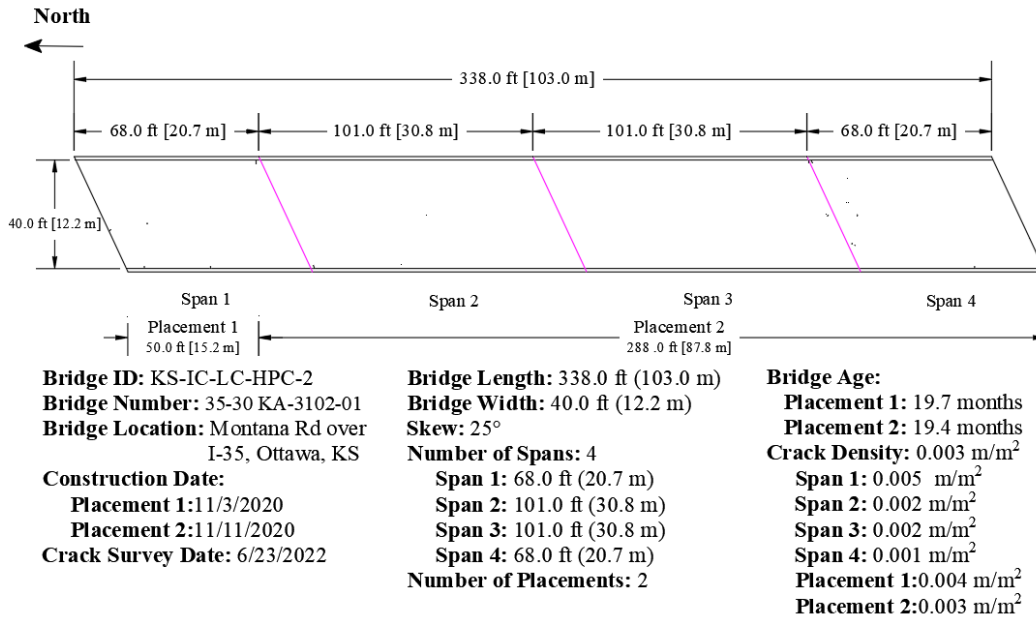

Figure 3.36: Crack Map for KS-IC-LC-HPC-2 (Survey 2)

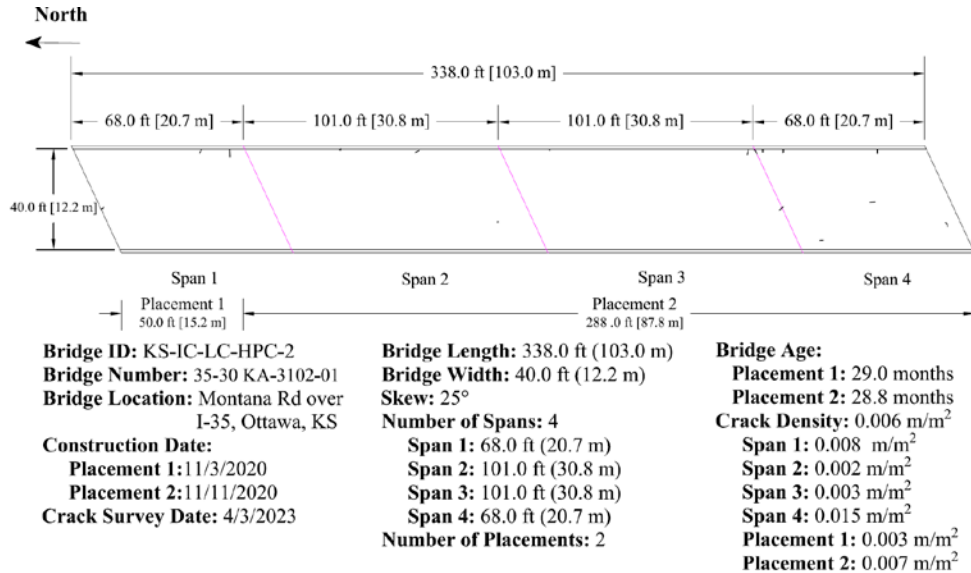

Figure 3.37: Crack Map for KS-IC-LC-HPC-2 (Survey 3)

Similar to KS-IC-LC-HPC-1 (Sunflower Rd. bridge deck), scaling damage was observed in multiple spots on the surface of KS-IC-LC-HPC-2 (Montana Rd. deck), as shown in Figure 3.38. The surface damage on this deck could be the result of multiple issues. As discussed in Section 2.7.2, during construction, workers made repeated bull float passes while bleed water was visible on the surface. Much of that excess water was worked back into the surface. Over-finishing the deck in the presence of bleed water, leads to a thin paste layer with a high w/cm at the concrete surface, which can result in scaling damage. Moreover, according to IC-LC-HPC specifications, no finishing aids are permitted. In spite of this, the contractor applied a finishing aid on the concrete for the entire deck. The use of the finishing aid increases the w/cm ratio at the surface, which may also contribute to increased scaling damage. This shortcoming was pointed out to the contract (non-KDOT) inspector who said that this was “not a big deal at this point.” Additionally, it was observed that the fogging system deposited excessive water on the bridge deck.



Figure 3.38: Scaling Damage Observed on Some Portions of KS-IC-LC-HPC-2

3.3.2.3 KS-IC-LC-HPC-3

KS-IC-LC-HPC-3 is a two-lane bridge that carries traffic on 199th St. over I-35 in Edgerton, Kansas. The deck was constructed in one placement on September 16, 2021. The deck has been surveyed twice. The surveys were performed at ages of 9.2 and 24.3 months and had crack densities of 0.061 and 0.068 m/m^2 , respectively. In both surveys, cracks were primarily located 60 ft (18.3 m) and 200 ft (70 m) from the east end of the deck, as shown in the crack maps in Figures 3.39 and 3.40. Scaling damage was also observed on portions of the decks the deck during both surveys, with greater intensity during the second survey (Figure 3.41). In both surveys, crack widths were similar, ranging from 0.003 to 0.020 in. (0.08 to 0.51 mm), with an average of 0.013 in. (0.33 mm). The cracks and scaling damage observed in those portions of the deck could be the result of multiple factors that occurred during the construction, as discussed in Section 2.7.3. Malfunctioning fogging equipment was observed spraying excess water directly onto the deck surface, especially in spans 3 and 4. The excess water was later worked back into the surface by the contractors when bull floating the deck, which resulted in a thin paste layer with a high w/cm at the concrete surface, causing high cracks in those areas. At 0.160 m/m^2 , the crack density in span 3 differed markedly from the rest of the deck and was quite high for an IC-LC-HPC deck. Although not permitted by the IC-LC-HPC specifications, a finishing aid was also used on the first

half of the deck. The finishing aid increases the w/cm ratio at the surface, which may contribute to increased scaling damage. The use of the finishing aid, however, was discontinued after it was pointed out to KDOT and contractor personnel. Additionally, a bull float was repeatedly used in the longitudinal direction while the excess water was visible on the surface.

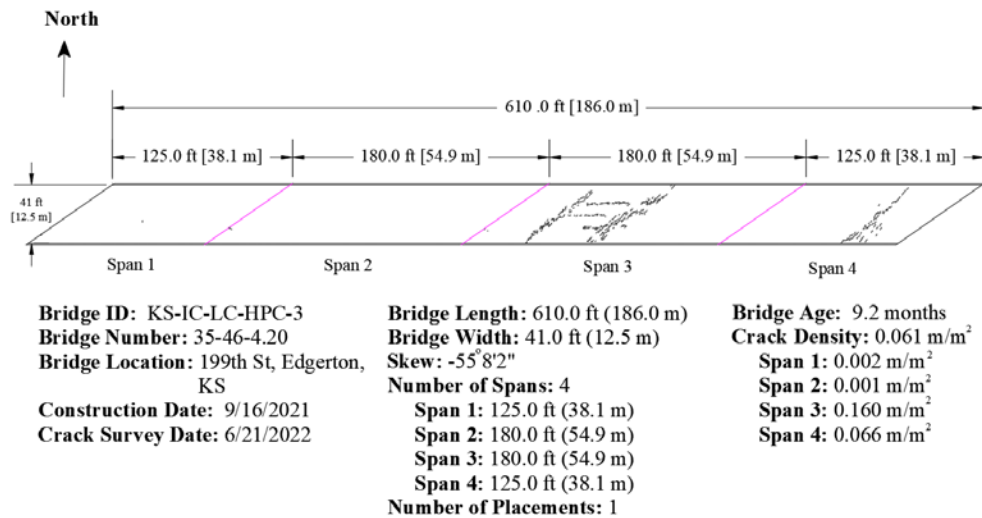

Figure 3.39: Crack Map for KS-IC-LC-HPC-3 (Survey 1)

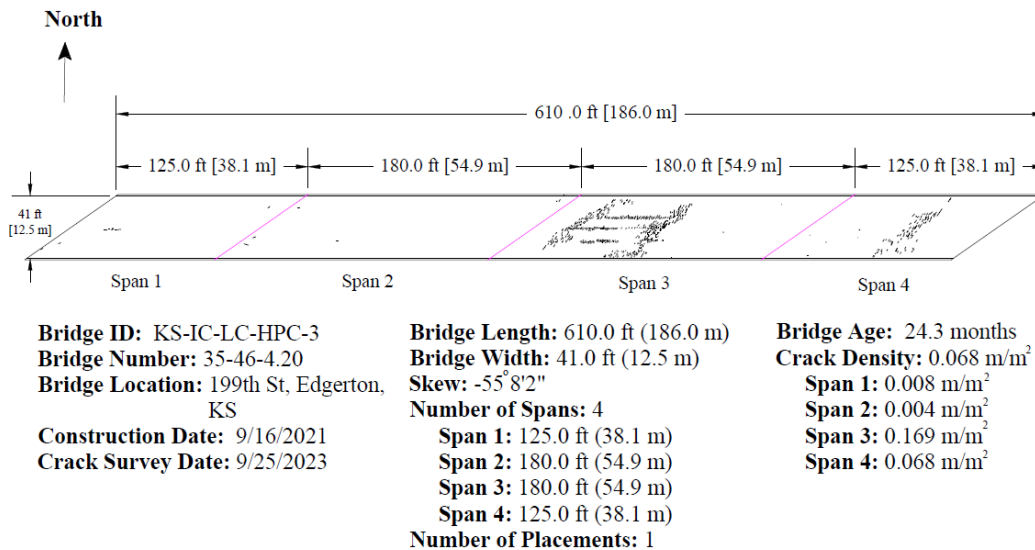

Figure 3.40: Crack Map for KS-IC-LC-HPC-3 (Survey 2)

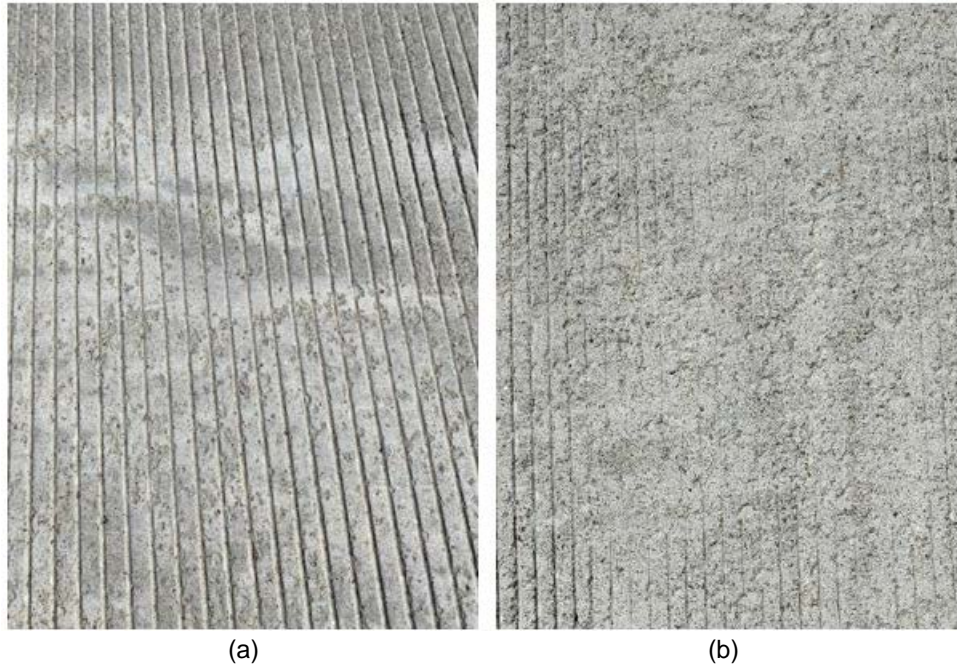

Figure 3.41: Scaling Damage Observed on Some Portions of KS-IC-LC-HPC-3 During (a) Survey 1 and (b) Survey 2

3.4 Cracking Performance of IC-LC-HPC Decks

Figure 3.42 shows crack density as a function of age for IC-LC-HPC and Control decks surveyed from 2017 to 2022 in Minnesota and Kansas.

The crack surveys show that the majority of the IC-LC-HPC decks constructed in Minnesota and Kansas have exhibited low crack densities (below 0.05 m/m^2 , shown in green) during the first two or three years (and longer for some decks) after the construction. For decks without overlays, the use of IC and SCMs reduced bridge deck cracking compared to the Control decks. No improvement, however, was noted for the two IC bridge decks with an overlay, where higher amounts of cracking were observed. It is well established that use of overlays can increase bridge deck cracking and decks with concrete overlays are also susceptible to map cracking (Miller & Darwin, 2000; Lindquist et al., 2005). The construction issues during placement of MN-IC-LC-HPC-5, -8, and -9, disturbance of previously consolidated concrete and delays in the initial curing likely contributed to increased crack densities. Span 3 of KS-IC-LC-HPC-3 also exhibited a high crack density that is likely associated with working excess bleed water back into the surface of the deck and the use of a finishing aid, rather than simply applying the wet burlap after strike-off.

Noticeable cracking is expected when decks are over-finished, excess water is worked into the surface, the concrete is not adequately consolidated, or early curing of the concrete is not provided. To date, the Kansas IC-LC-HPC decks have exhibited low crack densities, with the exception of span 3 of KS-IC-LC-HPC-3. The tendency to exhibit cracking over the long term, however, usually becomes apparent only after 36 months (Lindquist et al., 2008; Yuan et al., 2011; Pendergrass & Darwin, 2014). Therefore, future surveys will provide a better indicator of long-term cracking performance.

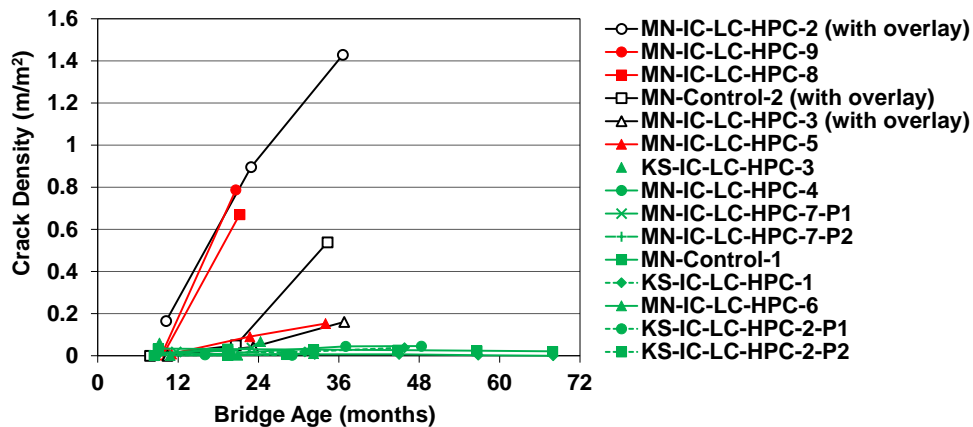

Figure 3.42: Crack Density as a Function of Age for IC-LC-HPC and Control Decks

3.4.1 Comparison with Kansas LC-HPC Decks

Figure 3.43 compares the cracking performance of the IC-LC-HPC monolithic decks with cracking in LC-HPC bridge decks in Kansas (Darwin et al., 2016). Bridge decks for which the contractor followed poor construction practices and decks with overlays are excluded from the figures. A single monolithic deck in Minnesota without internal curing water (MN-Control-1) is not shown in the figure because the study focuses on the effects of internal curing and SCMs on bridge deck cracking. As described in Chapter 1, LC-HPC decks were constructed between 2005 and 2011 in Kansas. LC-HPC mixtures have low paste contents (below 24.6%) to reduce shrinkage and all had crack densities below 0.4 m/m² through 48 months. Annual crack surveys performed on the LC-HPC decks demonstrated their improved cracking performance in comparison with

Control decks (Lindquist et al., 2008; McLeod et al., 2009; Yuan et al., 2011; Pendergrass & Darwin, 2014; Alhmoed et al., 2015; Darwin et al., 2016).

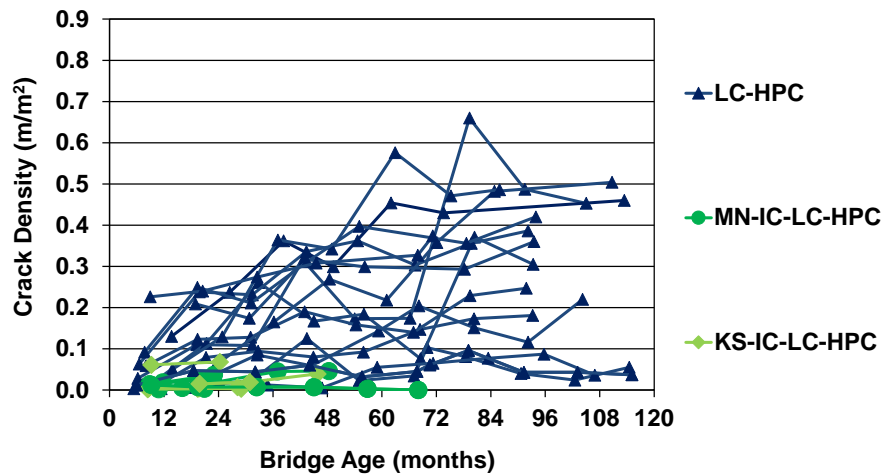

Figure 3.43: Crack Densities Versus Deck Age for Monolithic LC-HPC Decks, Minnesota, and Kansas IC-LC-HPC Decks with Good Construction Practices (all had paste contents of 26% or less)

As described in Chapter 2, both the Minnesota and Kansas IC-LC-HPC decks had low paste contents; the Minnesota IC-LC-HPC decks contained a binary cementitious system that included 27 to 30% mass replacement of cement with slag cement and a paste content ranging from 25.4 to 26%; the Kansas IC-LC-HPC decks contained either a binary cementitious system that included a 30% mass replacement of cement with slag cement and a paste content of 24.2%, or a ternary cementitious system that included 30% mass replacement of cement with slag cement and 2 or 3% mass replacement of cement with silica fume and a paste content of either 24.4 or 24.6%. As described in Chapter 1, given that decks with low paste contents exhibit low cracking, the low cracking of the IC-LC-HPC decks is not unexpected. As shown in Figure 3.43, the IC-LC-HPC decks exhibited better cracking performance (below 0.07 m/m² between 9 and 68 months after placement) than the LC-HPC decks.

3.4.2 Comparison with Utah and Indiana Decks

Figure 3.44 compares the cracking performance of the IC-LC-HPC decks surveyed in this study (MN-IC-LC-HPC and KS-IC-LC-HPC) with cracking in internally cured decks in Utah and

Indiana. As described in Section 1.4, the results of surveys are available for two IC decks in Utah (identified here as UT-IC), supported by prestressed girders with partial-depth precast concrete deck panels. The concrete for the decks had a w/cm ratio of 0.44 and a binary cementitious material system (with partial replacements of portland cement with fly ash), but the paste content was 28%. The concrete for the UT-IC decks was proportioned to provide a nominal IC water content of 7% by the weight of binder (Guthrie et al., 2014). Additionally, one IC deck containing portland cement as the only binder (identified as IN-IC) was constructed in 2010 in Indiana. This deck had a w/cm ratio of 0.39 and a paste content of 27.6%. The nominal quantity of IC water was 7.2% by the cement weight (Di Bella et al., 2012). In addition to these decks, four IC decks containing a ternary binder system (identified as IN-IC-HPC, with partial replacements of portland cement with either slag cement and silica fume or fly ash and silica fume) were constructed between 2013 and 2015 in Indiana. These decks had w/cm ratios ranging from 0.40 to 0.43 and lower paste contents than IN-IC, between 24.6 and 26.0%. They had IC water contents ranging from 8.5 to 12.0% by total weight of binder (Barrett et al., 2015). As shown in Figure 3.44, the IC-LC-HPC decks, all with paste contents below 27.2%, exhibited noticeably less cracking at similar ages than the internally cured Utah and Indiana decks (UT-IC and IN-IC) with paste contents greater than 27.2%.

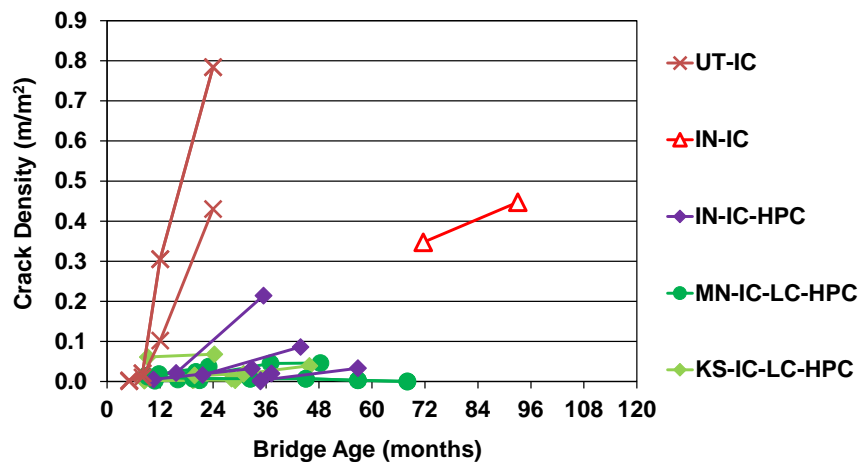

Figure 3.44: Crack Densities Versus Deck Age for Utah, Indiana, Minnesota, and Kansas IC Decks

In most cases, the IC-LC-HPC decks in this study, that had IC water contents ranging from 5.2 to 8% (by the weight of binder), exhibited lower crack densities at 36 months than the IN-IC-HPC decks (0.000 to 0.046 vs. 0.000 to 0.214 m/m²) at similar ages. These observations suggest that there is no apparent reduction in cracking when IC water is increased above 8% (by total weight of binder). Based on Figures 3.43 and 3.44, it can be concluded that IC and SCMs contributed noticeably to a reduction in cracking when the paste content is below 27.2%; for decks with paste contents greater than 27.2%, the addition of IC and SCMs cannot overcome the negative effects of high paste contents, resulting in high crack densities as is the case for UT-IC and IN-IC decks at similar ages to IN-IC-LC-HPC, MN-IC-LC-HPC, and KS-IC-LC-HPC decks.

Chapter 4 – Summary, Conclusions, and Recommendations

4.1 Summary

This study involves the construction, crack surveys, and evaluation of 12 bridge decks with internal curing (IC) provided by prewetted fine lightweight aggregate and supplementary cementitious materials (SCMs) following internally cured low-cracking high-performance concrete (IC-LC-HPC) specifications of Minnesota or Kansas and two associated Control decks without IC (MN-Control). The decks were monolithic with the exception of three of the Minnesota decks, which had an overlay. As cast, the internally cured low-cracking high-performance concrete used in the study had paste contents between 23.8 and 25.8 percent by volume. Of the 12 IC decks, nine (identified as MN-IC-LC-HPC-1 to -9) were constructed in Minnesota between 2016 and 2020, and three (identified as KS-IC-LC-HPC-1 to -3) were constructed in Kansas between 2019 and 2021. The performance of the decks is compared with that of earlier IC-LC-HPC bridge decks and low-cracking high-performance concrete (LC-HPC) bridge decks without internal curing. The effects of construction practices on cracking are addressed.

4.2 Conclusions

The following conclusions are based on the results and analyses presented in this study.

1. As demonstrated in earlier studies, the use of overlays on bridge decks is not beneficial in mitigating cracking; the two IC-LC-HPC bridge decks with an overlay exhibited much greater cracking than the IC-LC-HPC decks without an overlay. The use of overlays on bridge decks is not recommended and should be avoided.
2. With paste contents between 23.8 and 25.8 percent of the concrete volume, the IC-LC-HPC decks constructed in this study in conjunction with the Minnesota and Kansas IC-LC-HPC specifications exhibited lower average crack densities than those without IC. This indicates that the combination of low paste, internal curing, and good construction procedures offer the potential to reduce cracking, but because the number of bridges was small, it deserves further study.

3. Good construction practices are needed for low-cracking decks. If poor construction practices, including poor consolidation and disturbance of concrete after consolidation, over-finishing, delayed application of wet curing, and tining as one of the potential causes for delayed curing, are employed, even decks with low paste contents and IC can exhibit high cracking.
4. Delayed curing and over-finishing can also result in scaling damage to bridge decks.

4.3 Recommendations

1. The use of low paste content, proper consolidation, minimal finishing, early initiation of and extended curing can significantly reduce bridge deck cracking. Construction practices used by contractors for all bridge decks should be closely regulated by state transportation departments.
2. To minimize cracking, concrete should be thoroughly consolidated, and a strict prohibition should be imposed on walking in or disturbing concrete after consolidation. Over-finishing in an attempt to remove excess bleed water, as well as delayed application of curing, results in cracking and durability damage of bridge decks and, therefore, should not be permitted. Tining can disrupt the aggregates on the upper surface and prevent the early application of curing. To obtain a rough surface, it is better to grind and groove the deck surface instead of tining.
3. Curing compounds do not appear to mitigate cracking efficiently when compared to early wet curing (provided by wet burlap), as they slow down but do not stop drying. It is recommended that wet curing be initiated immediately after finishing.

References

- ACI Committee 308. (2016). *Guide to external curing of concrete* (ACI PRC-308-16), American Concrete Institute.
- ACI Committee 308 and ACI Committee 213. (2013). *Report on internally cured concrete using prewetted absorptive lightweight aggregate* (ACI PRC-308-13), American Concrete Institute.
- Alhmoor, A., Darwin, D., & O'Reilly, M. (2015). *Crack surveys of low-cracking high-performance concrete bridge decks in Kansas 2014-2015* (Report No. 15-3). The University of Kansas Center for Research. <http://hdl.handle.net/1808/19740>
- ASCE. (2021). *The 2021 Report Card for America's Infrastructure*. <https://www.infrastructurereportcard.org/cat-item/bridges>
- ASTM C666-15 (2015). *Standard test method for resistance of concrete to rapid freezing and thawing*. ASTM International. doi: 10.1520/C0666_C0666M-15, www.astm.org
- ASTM C672-12 (2012). *Standard test method for scaling resistance of concrete surfaces exposed to deicing chemicals*. ASTM International. doi: 10.1520/C0672_C0672M-12, www.astm.org
- ASTM C1202-19. (2019). *Standard test method for electrical indication of concrete's ability to resist chloride ion penetration*. ASTM International. doi: 10.1520/C1202-19, www.astm.org
- ASTM C1761/C1761M-17. (2017). *Standard specifications for internal curing of concrete*. ASTM International. doi: 10.1520/C1761_C1761M-17, www.astm.org
- Bahadori, A, Darwin, D., & O'Reilly, M. (2023). *Internally cured low-cracking high-performance concrete (IC-LC-HPC) bridge decks: Durability and cracking performance* (Report No. 149). University of Kansas Center for Research. <http://hdl.handle.net/1808/33978>
- Barrett, T., Miller, A., & Weiss, J. (2015). *Documentation of the INDOT experience and construction of the bridge decks containing internal curing in 2013* (Report No. 3752). Purdue University. <https://doi.org/10.5703/1288284315532>

- Bentz, D., & Snyder, K. A. (1999). Protected paste volume in concrete – Extension to internal curing using saturated lightweight fine aggregate. *Cement and Concrete Research*, 29(11), 1863-1867. <https://www.researchgate.net/publication/222306710>
- Bentz, D., & Weiss, J. (2011). *Internal curing: A 2010 state-of-the-art review* (Report No. NISTIR 7765). National Institute of Standards and Technology. <https://doi.org/10.6028/NIST.IR.7765>
- Browning, J., Darwin, D., Reynolds, D., & Pendergrass, B. (2011). Lightweight aggregate as an internal curing agent to limit concrete shrinkage. *ACI Materials Journal*, 108(6), 638-644. <https://doi.org/10.14359/51683467>
- Castro, J. (2011). *Moisture transport in cement based materials: Application to transport tests and internal curing* (Doctoral dissertation). Purdue University. Retrieved from <http://docs.lib.purdue.edu/dissertations/AAI3475407/>
- Cusson, D., & Hoogeveen, T. (2008). Internal curing of high-performance concrete with pre-soaked fine lightweight aggregate for prevention of autogenous shrinkage cracking. *Cement and Concrete Research*, 38(6), 757-765. https://www.academia.edu/download/49142819/Internal_curing_of_high-performance_concrete_with_pre-soaked_fine.pdf
- Darwin, D., Browning, J., & Lindquist, W. (2004). Control of cracking in bridge decks: Observations from the field. *Cement, Concrete, and Aggregates*, 26(2), 148-154. <https://doi.org/10.1520/CCA12320>
- Darwin, D., Khajehdehi, R., Alhmood, A., Feng, M., Lafikes, J., Ibrahim, E., & O'Reilly, M. (2016). *Construction of crack-free bridge decks: Final report* (Report No. 121). University of Kansas Center for Research. <http://hdl.handle.net/1808/23253>
- Di Bella, C., Schlitter, J., Carboneau, N., & Weiss, J. (2012). *Documenting the construction of a plain concrete bridge deck and an internally cured bridge deck* (Report No. TR-1-2012). Indiana LTAP Center. <https://docs.lib.purdue.edu/inltaptechs/2>

- Feng, M., & Darwin, D. (2020). Implementation of crack-reducing technologies for concrete in bridge decks: Synthetic fibers, internal curing, and shrinkage-reducing admixtures (Report No. 136). University of Kansas Center for Research. <https://doi.org/10.13140/RG.2.2.22490.36802>
- Guthrie, W. S., Yaede, J. M., Bitnoff, A. M. (2014). *Comparison of conventional and internally cured concrete bridge decks in Utah: Mountain view corridor project: Final report* (Report No. UT-15.02). Utah Department of Transportation. https://rosap.ntl.bts.gov/view/dot/28762/dot_28762_DS1.pdf
- Henkensiefken, R., Bentz, D., Nantung, T., & Weiss, W. J. (2009). Volume change and cracking in internally cured mixtures made with saturated lightweight aggregate under sealed and unsealed conditions. *Cement and Concrete Composites*, 31(7), 427-437. https://tsapps.nist.gov/publication/get_pdf.cfm?pub_id=923438
- Ibrahim, E., Darwin, D., & O'Reilly, M. (2019). Effect of crack-reducing technologies and supplementary cementitious materials on settlement cracking of plastic concrete and durability performance of hardened concrete (Report No. 134). University of Kansas Center for Research. <http://hdl.handle.net/1808/29640>
- Jones, W. A., House, M. W., Weiss, W. J. (2014). *Internal curing of high-performance concrete using lightweight aggregates and other techniques* (Report No. CDOT-2014-3). Colorado Department of Transportation. <https://www.codot.gov/programs/research/pdfs/2014/ic.pdf>
- Khajehdehi, R., & Darwin, D. (2018). *Controlling cracks in bridge decks* (Report No. 129). University of Kansas Center for Research. <http://hdl.handle.net/1808/27633>
- Khajehdehi, R., Darwin, D., & Feng, M. (2021). Dominant role of cement paste content on bridge deck cracking. *Journal of Bridge Engineering*, 26(7), 04021037. [https://doi.org/10.1061/\(ASCE\)BE.1943-5592.0001738](https://doi.org/10.1061/(ASCE)BE.1943-5592.0001738)
- Khayat, K., Meng, W., Valipour, M., & Hopkins, M. (2018). *Use of lightweight sand for internal curing to improve performance of concrete infrastructure* (Report No. cmr 18-005). Missouri Department of Transportation. <https://rosap.ntl.bts.gov/view/dot/36264>

- KT-79 Kansas Test Method. (2018). Surface resistivity indication of concrete's ability to resist chloride ion penetration. *Kansas Department of Transportation construction manual, Part V*. Kansas Department of Transportation.
- KTMR-21 Kansas Test Method. (2019). *Soundness of aggregates by freezing and thawing*. Kansas Department of Transportation.
- KTMR-22 (2012). *Resistance of concrete to rapid freezing and thawing*. Kansas Department of Transportation. <https://www.ksdot.gov/bureaus/burMatrRes/kt-mrs.asp>
- Lafikes, J., Khajehdehi, R., Feng, M., O'Reilly, M., & Darwin, D. (2018). *Internal curing and supplementary cementitious materials in bridge decks* (Report 18-2). University of Kansas Center for Research. <http://hdl.handle.net/1808/26306>
- Lafikes, J., Darwin, D., O'Reilly, M., Feng, M., Bahadori, A., and Khajehdehi, R. (2019). *Construction of low-cracking high-performance bridge decks incorporating new technology* (Report No. 132). University of Kansas Center for Research. <http://hdl.handle.net/1808/29607>
- Lafikes, J., Darwin, D., & O'Reilly, M. (2020). *Durability, construction, and early evaluation of low-cracking high-performance concrete (LC-HPC) bridge decks* (Report No. 141). University of Kansas Center for Research. <http://hdl.handle.net/1808/30571>
- Lindquist, W., Darwin, D., & Browning, J. (2005). *Cracking and chloride contents in reinforced concrete bridge decks* (Report No. 78). University of Kansas Center for Research. <http://hdl.handle.net/1808/20353>
- Lindquist, W., Darwin D., & Browning J. (2008). Development of low-cracking high-performance concrete (LC-HPC) bridge decks: Free shrinkage, mixture optimization, and concrete production (Report No. 92). University of Kansas Center for Research. <http://hdl.handle.net/1808/19944>
- Lindquist, W., Darwin, D., Browning, J., McLeod, H. A. K., Yuan, J., and Reynolds, D. (2015). Implementation of concrete aggregate optimization. *Construction & Building Materials*, 74, 49-56. <https://www.researchgate.net/publication/267634111>

- McLeod, H. A. K., Darwin, D., & Browning, J. (2009). Development and construction of low-cracking high-performance concrete (LC-HPC) bridge decks: Construction methods, specifications, and resistance to chloride ion penetration (Report No. 94). University of Kansas Center for Research. <http://hdl.handle.net/1808/19853>
- Miller, A., Barrett, T, Zander, A., and Weiss, W. J. (2014). Using a centrifuge to determine moisture properties of lightweight fine aggregate for use in internal curing. *Advances in Civil Engineering Materials*, 3, 142-157. <https://doi.org/10.1520/ACEM20130111>
- Miller, G., & Darwin, D. (2000). *Performance and constructability of silica fume bridge deck overlays* (Report No. 57). The University of Kansas Center for Research. <http://hdl.handle.net/1808/20469>
- Mindess, S., Young, F. & Darwin, D. (2003). *Concrete* (2nd ed.). Prentice-Hall.
- Minnesota Department of Transportation. (2018). *Standard specifications for construction*. <https://www.dot.state.mn.us/pre-letting/spec/>
- Pendergrass, B., and Darwin, D. (2014). *Low-Cracking high-performance concrete (LC-HPC) bridge decks: Shrinkage-Reducing admixtures, internal curing, and cracking performance* (Report No. 107). University of Kansas Center for Research, <http://hdl.handle.net/1808/19821>
- Pendergrass, B., Shrestha, P., Riedel, E., Polley, G., & Darwin, D. (2013). *Evaluation of cracking performance of bridge decks in Minnesota* (Report 13-4). University of Kansas Center for Research. <http://hdl.handle.net/1808/24714>
- Pilleo, R. E. (1991). Concrete science and reality. In J. P. Skalny & S. Mindess, (Eds.), *Materials science of concrete II* (pp. 1-8). American Ceramic Society.
- Radlińska, A. (2008). *Reliability-Based analysis of early-age cracking in concrete* (Doctoral dissertation). Purdue University. <https://docs.lib.purdue.edu/dissertations/AAI3344112/>
- Reynolds, D., Browning, J., & Darwin, D. (2009). *Lightweight aggregates as an internal curing agent for low-cracking high-performance concrete*, (Report No. 97). University of Kansas Center for Research. <http://hdl.handle.net/1808/19850>

- Rupnow, T., Collier, Z., Raghavendra, A., & Icenogle, P. (2016). *Evaluation of portland cement concrete with internal curing capabilities* (Report No. FHWA/LA.16/569). Louisiana Transportation Research Center. http://www.ltrclsu.edu/pdf/2016/FR_569.pdf
- Russell, H. G. (2004). *Concrete bridge deck performance* (NCHRP Synthesis 333). Transportation Research Board. <https://doi.org/10.17226/17608>
- Schlitter, J., Henkensiefken, R., Castro, J., Raoufi, K., Weiss, W. J., & Nantung, T. (2010). *Development of internally cured concrete for increased service life* (Report No. FHWA/IN/JTRP-2010/10). Purdue University. <https://doi.org/10.5703/1288284314262>
- Schmitt, T. R. & Darwin, D. (1995). *Cracking in concrete bridge decks* (Report No. 39). University of Kansas Center for Research. <http://hdl.handle.net/1808/20444>
- Schmitt, T. R. & Darwin, D. (1999). Effect of material properties on cracking in bridge decks. *Journal of Bridge Engineering*, 4, 8-13.
[https://doi.org/10.1061/\(ASCE\)10840702\(1999\)4:1\(8\)](https://doi.org/10.1061/(ASCE)10840702(1999)4:1(8))
- Shrestha, P. N., Harley, A., Pendergrass, B., Darwin, D., & Browning, J. (2013). *Use of innovative concrete mixes for improved constructability and sustainability of bridge decks, 2010-2013* (Report No. 13-3). University of Kansas Center for Research. <http://hdl.handle.net/1808/27377>
- Thomas, M. D. A. (2006). Chloride diffusion in high-performance lightweight aggregate concrete. *ACI Special Publication*, 234, 797-812. <https://doi.org/10.14359/15974>
- Triandafilou, L. (2005). Implementation of high-performance materials: When will they become standard? *Transportation Research Record: Journal of the Transportation Research Board*, CD 11-S, 33-48. <https://www.researchgate.net/publication/279285220>
- Villarreal, V. H. & Crocker, D. A. (2007). Better pavements through internal hydration. *Concrete International*, 29(2), 32-36. <https://www.escsi.org/wp-content/uploads/2017/10/Concrete-Intl-Article-Feb-2007-Better-Pavements.pdf>
- Weber, S., & Reinhardt, H. W. (1997). A new generation of high-performance concrete: concrete with autogenous curing. *Advanced Cement Based Materials*, 6(2), 59-68. [https://doi.org/10.1016/S1065-7355\(97\)00009-6](https://doi.org/10.1016/S1065-7355(97)00009-6)

- Wei, Y., & Hansen, W. (2008). Pre-Soaked lightweight fine aggregates as additives for internal curing in concrete. In B.J. Mohr & D.P. Bentz (Eds.), *Internal curing of high-performance concrete: Lab and field experiences* (ACI SP-256, pp. 35-44). American Concrete Institute. <https://doi.org/10.14359/20229>
- Yuan, J., Darwin, D., & Browning, J. (2011). *Development and construction of low-cracking high-performance concrete (LC-HPC) bridge decks: Free shrinkage tests, restrained ring tests, construction experience, and crack survey results* (Report No. 103). University of Kansas Center for Research. <http://hdl.handle.net/1808/19834>

Appendix A: IC-LC-HPC Construction Evaluation Spreadsheet

No.	VARIABLE* (in order of completion)		Notes
1	Even sprinkling of FLWA	<input type="checkbox"/>	
2	FLWA sprinkled for at least 72 hours or until moisture content becomes constant	<input type="checkbox"/>	
3	Sprinkling of FLWA stopped 24 hours prior to batching to allow drainage	<input type="checkbox"/>	
4	Absorption of FLWA is tested within 24 hours of batching	<input type="checkbox"/>	
5	Mix proportions are modified based on absorption measurement	<input type="checkbox"/>	
6	FLWA Free-surface moisture is tested within 1 hour of batching	<input type="checkbox"/>	
7	Admixtures are added per manufacturer's suggestions / at time of batching	<input type="checkbox"/>	
8	Tracking the quantity of water withheld on trip tickets at the job site	<input type="checkbox"/>	
9	Time between batching and discharge less than 90 minutes	<input type="checkbox"/>	
10	Good communication between DOT and the contractor personnel	<input type="checkbox"/>	
11	Forms and reinforcement are uniformly wet	<input type="checkbox"/>	
12	Pumpable concrete	<input type="checkbox"/>	
13	Slump within specification	<input type="checkbox"/>	

No.	VARIABLE* (in order of completion)		Notes
14	Air content within specification	<input type="checkbox"/>	
15	Temperature within specification	<input type="checkbox"/>	
16	Evaporation rate below specification limit	<input type="checkbox"/>	
17	Adequate consolidation	<input type="checkbox"/>	
18	No disturbance of concrete after consolidation	<input type="checkbox"/>	
19	Minimized finishing (no over-finishing)	<input type="checkbox"/>	
20	Time between placing and finishing less than 15 minutes	<input type="checkbox"/>	
21	Time between finishing and first layer of burlap less than 15 minutes	<input type="checkbox"/>	
22	Time between first and second layers of burlap less than 15 minutes	<input type="checkbox"/>	
23	Burlap fully saturated for a minimum of 12 hours prior to placement on the deck	<input type="checkbox"/>	
24	Concrete completely covered with burlap	<input type="checkbox"/>	
25	Soaker hoses uniformly wet the burlap	<input type="checkbox"/>	
26	Proper curing conditions through 14 days after placement	<input type="checkbox"/>	
27	Formwork removed within 4 weeks of end of curing	<input type="checkbox"/>	

28	Concrete compressive strength within specification	<input type="checkbox"/>	
Total	Number of "Selected Checkboxes" for Project	0	

* Concrete Supplier Variable

CONCRETE SUPPLIER	0	out of 13
CONTRACTOR	0	out of 15

Appendix B: Minnesota Department of Transportation Specifications for Internally Cured Low-Cracking High- Performance Concrete

SB2-8 (2401) CONCRETE BRIDGE CONSTRUCTION

The provisions of 2401, "Concrete Bridge Construction," are supplemented as follows:

SB2-9 STRUCTURAL CONCRETE – INTERNALLY CURED HIGH PERFORMANCE CONCRETE BRIDGE DECKS (CONTRACTOR CONCRETE MIX DESIGN)

Delete the contents of 2401.2.A, "Concrete," and replace with the following:

Design an internally cured concrete mixture that will minimize cracking by incorporating saturated lightweight fine aggregate. Perform the work in accordance with the applicable requirements of MnDOT 2401, "Concrete Bridge Construction," 2461, "Structural Concrete," and the following:

2.A.1 Fine Aggregate Requirements

Provide fine aggregates complying with quality requirements of 3126.2.D, "Deleterious Material," 3126.2.E, "Organic Impurities," and 3126.2.F, "Structural Strength."

2.A.1.a Fine Aggregate Lightweight Requirements

Incorporate fine lightweight aggregate as a means to provide internal curing water for concrete. The requirements of ASTM C1761 and C330 shall apply, except as modified in this specification.

- (1) Size all lightweight aggregate to pass a 3/8 in. sieve.
- (2) Proportion the volume of lightweight aggregate such that it does not exceed 10 percent of total aggregate volume. Lightweight aggregate

used as a replacement for normal weight aggregate shall be made on a volume basis.

- (3) Prewet lightweight aggregate prior to adding at the time of batching. Recommendations for prewetting made by the lightweight aggregate supplier shall be followed to ensure that the lightweight aggregate has achieved an acceptable absorbed moisture content at the time of batching. Mixture proportions shall not be adjusted based on the absorbed water in the lightweight aggregate.

- (4) Handling and Stockpiling Lightweight Aggregates:

Keep aggregates from different sources, with different gradings or with a significantly different specific gravity separated.

Transport aggregate in a manner that insures uniform grading.

Do not use aggregates that have become mixed with earth or foreign material.

Stockpile or bin all washed aggregate produced or handled by hydraulic methods for 12 hours (minimum) before batching. Rail shipment exceeding 12 hours is acceptable for binning provided the car bodies permit free drainage.

Provide additional stockpiling or binning in cases of high or non-uniform moisture.

2.A.1.b Fine Aggregate Alkali Silica Reactivity (ASR) Requirements

The Department will routinely test fine aggregate sources for alkali silica reactivity (ASR) in accordance with the following:

- (1) Multiple sources of certified portland cement in accordance with ASTM C 1260 MnDOT Modified; and

- (2) Multiple combinations of certified portland cement and supplementary cementitious materials in accordance with ASTM C 1567 MnDOT Modified.

The Concrete Engineer, in conjunction with the engineer, will review the 14-day fine aggregate expansion test results to determine the acceptability of the proposed fine aggregate and cement combination in accordance with the following:

- (1) For fine aggregate and cement combinations previously tested by the Department, the concrete engineer will use the average of all 14-day unmitigated test results for an individual source to determine necessary mitigation in accordance with Table HPC-1.
- (2) If the previously tested proposed fine aggregate and cement combination requires less mitigation than the average 14-day unmitigated test result, the concrete engineer will allow mitigation at the lesser rate in accordance with Table HPC-1.
- (3) Alkali silica reactivity (ASR) ASTM C1260 and ASTM C1567 test results are available on the MnDOT Concrete Engineering Unit website.

Table HPC-1 Fine Aggregate ASR Mitigation Requirements							
14-day Fine Aggregate Unmitigated Expansion Limits	Class F Fly Ash	Class C Fly Ash	Slag	Slag/Class F Fly Ash	Slag/Class C Fly Ash	IS(20)/Class F Fly Ash	IS(20)/Class C Fly Ash
≤ 0.150	No mitigation required						
>0.150 - 0.200	Not Allowed	Not Allowed	35%	Not Allowed	Not Allowed	Not Allowed	Not Allowed
> 0.200 – 0.300	Not Allowed	Not Allowed	35%				
> 0.300	The Department will reject the fine aggregate						

The Concrete Engineer may reject the fine aggregate if mortar bar specimens exhibit an indication of external or internal distress not represented by the expansion results. The concrete engineer will make the final acceptance of the aggregate.

2.A.2 Intermediate Aggregate Requirements

Provide intermediate aggregates complying with the quality requirements of 3137.2.D.2, "Coarse Aggregate for Bridge Superstructure," except as modified in Table HPC-2. If the intermediate aggregate is from the same source as the 3/4 in. fraction, the aggregate quality is determined based upon the composite of the 3/4 in. and intermediate aggregate.

The Concrete Engineer classifies intermediate aggregate in accordance with Table HPC-2.

Table HPC-2 Intermediate Aggregate for Use in Concrete			
If the gradation meets the following:	Classify material type as:	Gradation Test Procedures	Quality Test Requirements
100% passing the 1/2" and ≤90% passing #4	Intermediate Aggregate	Coarse Aggregate (+4 Portion)	Spec. 3137.2.D.2 except 3137.2.D.2(i) modified to maximum 40% carbonate
		Fine Aggregate (-4 Portion)	Shale in Sand (-4 Portion)
100% passing the 1/2" and >90% passing #4	Intermediate Aggregate	Fine Aggregate (Minimum 1000 g sample)	Shale Content Test by AASHTO T113 MnDOT Modified (+4 Portion)
			Shale in Sand (-4 Portion)
100% passing the 3/8" and ≤90% passing #4	Coarse Sand	Fine Aggregate	Shale Content Test by AASHTO T113 MnDOT Modified (+4 Portion)
			Shale in Sand (-4 Portion)

For any intermediate aggregate size not previously tested by the Department, the concrete engineer reserves the right to test for alkali silica reactivity, in accordance with ASTM C1260, prior to allowing incorporation into the concrete mix design.

2.A.3 Coarse Aggregate Requirements

Provide Class A, B or C coarse aggregate meeting the quality requirements in accordance with 3137.2.D.2, "Coarse Aggregate for Bridge Superstructure."

When providing Class B aggregate, the maximum absorption percent by weight is 1.10%.

2.A.3.a Coarse Aggregate Alkali Silica Reactivity (ASR) Requirements

When using coarse aggregate identified as quartzite or gneiss, the concrete engineer will review ASTM C1293 testing to determine the necessary ASR mitigation requirements in accordance with Table HPC-3.

ASR ASTM C1293 test results are available on the MnDOT Concrete Engineering Unit website.

Table HPC-3 Coarse Aggregate ASR Mitigation Requirements*							
ASTM C1293 Expansion Results	Class F Fly Ash	Class C Fly Ash	Slag	Slag/Class F Fly Ash	Slag/Class C Fly Ash	IS(20)/Class F Fly Ash	IS(20)/Class C Fly Ash
≤ 0.040	No mitigation required						
>0.040	Not Allowed	Not Allowed	35%	Not Allowed	Not Allowed	Not Allowed	Not Allowed

* The engineer will allow the Contractor to substitute a portion of the minimum required supplementary cementitious material with up to 2% silica fume by weight for mitigation purposes.

2.A.4 Cementitious Materials

Provide only cementitious materials from the Approved/Qualified Products List.

2.A.4.a Cement

Use Type I or Type I/II cement complying with Specification 3101, "Portland Cement," or blended cement in accordance with Specification 3103, "Blended Hydraulic Cement."

- (1) Total alkalis (Na_2Oe) no greater than 0.60 percent in the portland cement, and
- (2) Total alkalis (Na_2Oe) no greater than 3.0 lb per yd^3 of concrete resulting from the portland cement.

2.A.4.b Ground Granulated Blast Furnace Slag

Use ground granulated blast furnace slag conforming to Specification 3102, "Ground Granulated Blast-Furnace Slag."

2.A.4.c Silica Fume

Use silica fume conforming to ASTM C 1240.

2.A.4.d Ternary Mixes

Ternary mixes are defined as portland cement and two other supplementary cementitious materials, or blended cement and one other supplementary cementitious material with a maximum replacement of 40% by weight.

2.A.5 Allowable Admixtures

Use any of the following admixtures on the MnDOT Approved/Qualified Products as listed under "Concrete Admixtures A-S":

- (A) Type A, Water Reducing Admixture,
- (B) Type B, Retarding Admixture,
- (C) Type C, Accelerating Admixture,
- (D) Type D, Water Reducing and Retarding Admixture,
- (E) Type F, High Range Water Reducing Admixture, and
- (F) Type S, Specific Performance Based Admixture

Obtain a written statement from the manufacturer of the admixtures verifying:

- (1) Compatibility of the combination of materials, and
- (2) Manufacturer recommended sequence of incorporating the admixtures into the concrete.

The manufacturer will further designate a technical representative to dispense the admixture products.

Utilize the technical representative in an advisory capacity and have them report to the contractor any operations or procedures which are considered as detrimental to the integrity of the placement. Verify with the engineer whether the manufacturer's technical representative's presence is required during the concrete placement.

2.A.6 Concrete Mix Design Requirements

Submit the concrete mixes using the appropriate MnDOT Contractor Mix Design Submittal Workbook available on the Department's website at least 21 calendar days before the initial concrete placement. For mix design calculations, the engineer, in conjunction with the concrete engineer, will provide specific gravity and absorption data.

The concrete engineer, in conjunction with the engineer, will review the mix design submittal for compliance with the contract.

2.A.6.a Concrete Mix Design Requirements

Design and produce 3YHPCIC-M or 3YPHCIC-S concrete mixes based on an absolute volume of 27.0 ft³ [1.0 m³] in accordance with the Table HPC-4 and the following requirements:

Table HPC-4 High Performance Bridge Deck Concrete Mix Design Requirements								
Concrete Grade	Mix Number *	Intended Use	w/cm ratio	Target Air Content	Maximum %SCM (Fly Ash/Slag/Silica Fume/Ternary)	Slump Range †, inches	Minimum/Maximum Compressive Strength, f'c (28-day)	3137 Spec.
HPC	3YHPCIC-M	Bridge Deck – Monolithic	0.43-0.45	6.5% to 10%	0/28/2/30	1 1/2" to 5 "	4000psi/5500 psi	2.D.2
	3YHPCIC-S	Bridge – Structural Slab						
<p>* Provide a Job Mix Formula in accordance with 2401.2.A.7. Use any good standard practice to develop a job mix formula and gradation working range by using procedures such as but not limited to 8-18, 8-20 gradation control, Shilstone process, FHWA 0.45 power chart or any other performance related gradation control to produce a workable and pumpable concrete mixture meeting all the requirements of this contract.</p> <p> The individual limits of each SCM shall apply to ternary mixtures.</p> <p>† Keep the consistency of the concrete uniform during entire placement. Limit volume of water plus cementitious materials to a maximum of 27% of total concrete volume.</p> <p>Add all mix water at the plant. No water will be allowed to be added on site.</p>								

2.A.6.b Required Preliminary Testing

Prior to placement of any 3YHPCIC-M or 3YHPCIC-S Concrete, the Engineer will require preliminary batching and testing of the concrete mix design.

Submit the concrete mixes using the appropriate MnDOT Contractor Mix Design Submittal Workbook available on the Department’s website at least 14 calendar days prior to the beginning of preliminary laboratory mixing and testing of the proposed mix designs. Any changes or adjustments to the material or mix design require a new contractor mix design submittal. For mix design calculations, the engineer, in conjunction with the concrete engineer, will provide specific gravity and absorption data.

The concrete engineer, in conjunction with the Engineer, will review the mix design submittal for compliance with the contract.

Batch the concrete and place in mixing truck for the max anticipated delivery time. Test the concrete for the following hardened concrete properties in accordance with Table HPC-5:

Table HPC-5 Required Hardened Concrete Properties for Mixes 3YHPCIC-M and 3YHPCIC-S		
Test	Requirement	Test Method
Required Strength (Average of 3 cylinders)	4000 psi min. at 28 days, 5500 psi max. at 28 days	ASTM C31
Rapid Chloride Permeability	≤ 2500 coulombs at 28 days (For Preliminary Approval) ≤ 1500 coulombs at 56 days	ASTM C1202
Freeze-Thaw Durability	Greater than 90% at 300 cycles	ASTM C666 Procedure A
Shrinkage	No greater than 0.040 percent at 28 days	ASTM C157
Scaling	Visual rating not greater than 1 at 50 cycles	ASTM C672

The engineer will allow the maturity method for subsequent strength determination. Perform all maturity testing in accordance with ASTM C1074 and the MnDOT Concrete Manual.

If a mix is approved, the concrete engineer will consider the mix design and testing as acceptable for a period of 5 years provided the actual concrete mixed and placed in the field meets the contract requirements. The concrete engineer will not require new testing within that 5-year period as long as all the constituents (including the aggregates) of the proposed mix design are the same as the original mix design.

The engineer determines final acceptance of concrete for payment based on satisfactory field placement and performance.

2.A.7 Job Mix Formula

A Job Mix Formula (JMF) contains the following:

- (a) Proportions for each aggregate fraction,
- (b) Individual gradations for each aggregate fraction, and

(c) Composite gradation of the combined aggregates including working ranges on each sieve in accordance with Table HPC-6.

Table HPC-6 Job Mix Formula Working Range	
Sieve Sizes	Working Range, %*
1 in [25 mm] and larger	±5
¾ in [19 mm]	±5
½ in [12.5 mm]	±5
⅜ in [9.5 mm]	±5
No.4 [4.75 mm]	±5
No.8 [2.36 mm]	±4
No.16 [1.18 mm]	±4
No.30 [600 µm]	±4
No.50 [300 µm]	±3
No.100 [150 µm]	±2
No.200 [75 µm]	≤ 1.6
*Working range limits of the composite gradation based on a moving average of 4 tests (N=4).	

2.A.7.a Verification of JMF

Prior to beginning placements of bridge deck concrete, perform gradation testing to ensure current materials comply with the approved JMF. Perform gradation testing in accordance with the Schedule of Materials Control.

- (1) Take samples at the belt leading to the weigh hopper or other locations close to the incorporation of the work as approved by the Engineer.
- (2) Add fill-in sieves as needed during the testing process to prevent overloading.

The producer and engineer will test and record the individual gradation results using the Concrete Aggregate Worksheet.

- (1) Using the JMF Moving Average Summary Worksheet, calculate the moving average of Producer aggregate gradation test results during production.
- (2) The engineer will randomly verify producer combined aggregate gradation results as defined in the Schedule of Materials Control.

If, during production, the approved JMF falls outside of the allowable working range immediately sample and test additional gradation and continue production.

2.A.7.b JMF Adjustment

If it is determined that the current aggregates do not meet the approved JMF, submit a new mix design including JMF to the concrete engineer in accordance with 2401.2.A.7.

2.A.7.c JMF Acceptance

The Engineer will make monetary adjustments for the quantity of bridge deck concrete represented by the JMF Working Range failure, from the failing test to the next passing test, at a minimum rate of \$500.00 or \$5.00 per cubic yard, whichever is greater.

2.A.8 Laboratory batching, testing requirements and submittals:

To determine the characteristics of the contractor proposed mix design, the concrete engineer will require the contractor to prepare test batches and do laboratory testing. Conduct all batching and testing of concrete at a **single** AMRL certified laboratory using the exact materials proposed in the mix design.

Lab testing requirements:

- (a) Slump and air content at <5 minutes, 15 minutes, and 30 minutes after the completion of mixing,
- (b) Compressive strength (Make cylinders in accordance with AASHTO T126 and tested in accordance with AASHTO T22) at 1, 3, 7, 28, 56 days (sets of three),
- (c) Hardened air content (ASTM C457) at a minimum of 7 days,
- (d) Rapid chloride permeability (ASTM C1202) at 28 days and 56 days (two specimens for 28-day test and 2 test specimens for 56 day test (Take two specimens from each batch of a two batch mix)),
- (e) Concrete Durability (ASTM C666, Procedure A) at 300 cycles, and
- (f) Concrete Shrinkage (ASTM C157) at 28 days.

The Contractor is required to contact the MnDOT Concrete Engineering Unit a minimum of 2 days prior to any mixing so that an MnDOT representative can observe the process. This same 2-day notification is required prior to any physical testing on hardened concrete samples. Additionally, retain any hardened concrete test specimens for a minimum of 90 days and make available for MnDOT to examine.

Perform all testing for plastic concrete after all admixtures additions to the concrete mixture.

After completion of the laboratory testing specified herein and, at least, 15 working days prior to the trial placement, submit the laboratory test data to the MnDOT for review and acceptance.

Include the following information in the laboratory reports of the design mixes:

- (a) Exact batch weights and properties of all ingredients used and all aggregate gradations
- (b) Slump and air content
- (c) Cylinder identification, including mix designation
- (d) Date and time of cylinder preparation
- (e) Date and time cylinder specimen was tested
- (f) Compressive strength of each cylinder specimen at 1, 3, 7, 28, and 56 day (sets of three)
- (g) A graphic plot of age, from 0 to 56 days, vs. strength for each mix design
- (h) Hardened air content at a minimum of 7 days
- (i) Rapid chloride permeability at 28 days and 56 days
- (j) Concrete Durability at 300 cycles and
- (k) Concrete Shrinkage at 28 days.

2.A.9 Prior to Actual Bridge Deck Placement

2.A.9.a Trial Placement

A minimum of 14 calendar days prior to the actual placement of the bridge deck slab concrete, successfully complete a separate trial placement utilizing a minimum of two (2) - 10 yd³ loads.

The engineer may allow the incorporation of the concrete for trial batches into the bridge footings, abutments, or end diaphragms. The contractor may also choose to incorporate the trial batches into residential/commercial construction in the immediate vicinity of the project. In any case, the engineer will require mixing, transporting, and placing the concrete using the same methods as the actual placement of the bridge deck.

If the concrete is incorporated into the permanent work, the engineer will test the plastic concrete in accordance with the Schedule of Materials Control. The engineer may require additional trial batches if the concrete delivered to the project does not comply with the plastic concrete requirements of the contract.

The concrete mix design, laboratory batching and mixing, and the trial placement is incidental to the concrete furnished and placed.

Use the same materials, same supplier, and same supplier's manufacturing plant, and proportions in the permanent work as in the trial placement. Strength requirements specified for each mix are applicable to the cylinder tests taken during the production work.

2.A.9.b Slab Placement and Curing Plan

At least 14 calendar days prior to slab placement, provide a slab placement and curing plan for each bridge to the Engineer for approval. Include the following information in the placement and curing plan:

- (1) Anticipated concrete delivery rates
- (2) Estimated start and finish time
- (3) Material, labor and equipment proposed for placing, finishing, and curing including placement of wet burlap, soaker hose, or other system to maintain the deck in a moist condition during the curing period
- (4) Number of work bridges proposed for use
- (5) Number of people responsible for the various tasks and
- (6) Bulkheading methods and materials proposed for use if the Contractor cannot maintain the proposed concrete placement rates.

For full depth monolithic decks, the finishing machine will consist of a cylindrical finisher mated with horizontal adjustable augers, both of which are mounted on a transversely moving carriage unless otherwise approved by the State Bridge Construction Engineer.

A 10 ft [3 m] bull float is required for full-depth decks prior to carpet dragging regardless of whether texture planing is specified for the final ride surface. Float slab in accordance with MnDOT Construction Manual 5-393.358 to ensure the final surface does not vary by greater than $\frac{1}{8}$ in. [3 mm] within a 10 ft [3 m] straightedge laid longitudinally on the final surface. This surface tolerance includes areas near expansion devices and other breaks in the continuity of the bridge slab.

Attend a pre-placement meeting 10 days to 15 days before the slab placement to review the information and details provided in the placement and curing plan. The following project personnel are required to attend the pre-placement meeting:

- (1) Contractor
- (2) Engineer
- (3) Concrete supplier and
- (4) If required by the Engineer, the concrete pump supplier.

2.A.9.c Three (3) Hours Prior to Beginning Bridge Deck Concrete Placement

The Engineer requires the Contractor to comply with all of the following conditions prior to allowing the Contractor to begin the bridge deck concrete placement:

- (1) Provide a forecast to the engineer three (3) hours before placement. The Engineer will review the forecast for the following:
 - (a) No forecasted precipitation two (2) hours prior to the scheduled placement duration, nor up to two (2) hours after the anticipated completion of the placement, and
 - (b) Less than 30% chance of precipitation for the entire placement window and
- (2) Only if the combination of air temperature, relative humidity, concrete temperature and wind velocity produces an evaporation rate of less than 0.20 lbs per square foot of surface area per hour, according to Figure HPC-1:

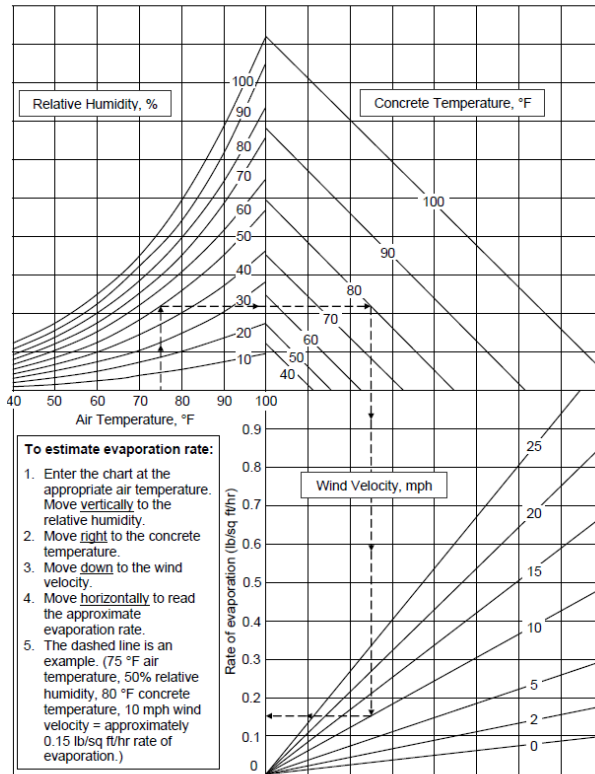

¹ Based on ACI 305 R, "Hot Weather Concreting"

FIGURE HPC-1

SB2-9.1 Concrete Curing and Protection

Delete the 16th paragraph through 18th paragraphs of 2401.3.G, "Concrete Curing and Protection," and replace with the following:

2.A.9.d Actual Bridge Deck Placement and Curing Requirements

In addition to the requirements set forth in 2461.3.G.4, "Field Adjustments," if any adjustments are necessary on site, comply with the following:

- (1) The engineer will only allow the addition of admixtures originally incorporated into the mix, except Viscosity-Modifying Admixture (VMA) is allowed to adjust slump even if they were not used in the original testing

- (2) The engineer will allow a maximum of one gal of water additions per yd³ of concrete on site provided additional water is available to add per the Certificate of Compliance, including any water necessary to dilute admixtures and
- (3) Mix the load a minimum of 5 minutes or 50 revolutions after any additions.

The engineer will not allow finishing aids or evaporation retarders for use in finishing of the concrete.

The contractor is fully responsible for curing methods. Comply with the following curing methods unless other methods are approved by the engineer in writing.

Table HPC-7 Required Curing Method Based on Final Bridge Deck Surface		
Bridge Deck Type	Final Bridge Deck Surface	Required Curing Method
Bridge structural slab curing (3YHPCIC-S)	Low Slump Wearing Course	Conventional wet curing after carpet drag
Bridge deck slab curing for full-depth decks (3YHPCIC-M)	Epoxy Chip Seal Wearing Course or Premixed Polymer Wearing Course	Conventional wet curing after carpet drag
	Bridge Deck Planing	Conventional wet curing after carpet drag.
	Tined Texturing*	Conventional wet curing after tine texturing AMS curing Compound after wet cure period
	Finished Sidewalk or Trail Portion of Deck (without separate pour above)*	Conventional wet curing after applying transverse broom finish AMS curing Compound after wet cure period
Apply conventional wet curing to bridge slabs following the finishing machine or air screed. * Prevent marring of broomed finish or tined textured surface by careful placement of wet curing.		

Use conventional wet curing consisting of prewetted burlap covered with white plastic sheeting in accordance with the following. Presoak the burlap for a minimum of 12 hours prior to application:

- (1) Place the burlap to cover 100 percent of the deck area without visible openings
- (2) Place the wet curing within 20 min after the finishing machine completes the final strike-off of the concrete surface
- (3) If the contractor fails to place the wet curing within 20 min, the Department will monetarily deduct \$500 for every 5 min period, or any portion thereof, after the initial time period until the contractor places the wet curing as approved by the engineer, the Department may assess the deduction more than once
- (4) Keep the slab surface continuously wet for an initial curing period of at least 7 calendar days
- (5) Use a work bridge to follow the finish machine and
- (6) Provide an additional center rail on wide bridges, if necessary.

Where marring of the broomed finish or tined texturing surface finish is a concern, the engineer may authorize curing as follows:

- (1) Apply a membrane curing compound meeting the requirements of 3754, "Poly-Alpha Methylstyrene (AMS) Membrane Curing Compound"
- (2) Apply curing compound using approved power-operated spray equipment
- (3) Provide a uniform, solid white, opaque coverage of membrane cure material on exposed concrete surfaces (equal to a white sheet of paper)
- (4) Place the membrane cure within 30 min of concrete placement unless otherwise directed by the engineer
- (5) Provide curing compound for moisture retention until the placement of a conventional wet curing

- (6) Apply conventional wet curing when walking on the concrete will not produce imprints deeper than $\frac{1}{16}$ in. [1.6 mm]
- (7) Keep the deck slab surface continuously wet for an initial curing period of at least 7 calendar days including weekends, holidays, or both if these fall within the 7-calendar-day curing period
- (8) The engineer will not allow placement of membrane curing compound on any concrete surface that expects future placement of additional concrete on that surface and
- (9) If the Contractor fails to meet these requirements, the Department may reduce the contract unit price for the concrete item in accordance with 1512, "Conformity with Contract Documents."

A. Method of Measurement

If measuring bridge slab concrete by area, the Engineer will base the measurement on end-of-slab stationing and out-to-out transverse dimensions of the slab.

B. Basis of Payment

Payment for Item No. 2401.618 "BRIDGE SLAB CONCRETE (3YHPCIC-M)" will be made at the contract price per square foot and shall be compensation in full for all costs of forming, placing, finishing, curing, crack sealing, and all associated incidentals necessary to construct the bridge deck and end diaphragms as detailed in the plans in accordance with these specifications.

Appendix C: Kansas Department of Transportation Specifications for Low-Cracking High-Performance Concrete (LC-HPC)-General, Aggregates, Concrete, and Construction

KANSAS DEPARTMENT OF TRANSPORTATION SPECIAL PROVISION TO THE STANDARD SPECIFICATIONS, EDITION 2015

For Low-Cracking High-Performance Concrete – Concrete, delete SECTION 401 and replace with the following:

GENERAL LOW-CRACKING HIGH-PERFORMANCE CONCRETE - CONCRETE

401.1 DESCRIPTION

Provide the grades of concrete specified in the Contract Documents.
See **15-PS0167** for specific requirements for Structural Concrete.
See **SECTION 403** for specific requirements for On Grade Concrete.
See **SECTION 404** for specific requirements for Prestressed Concrete.

401.2 MATERIALS

Provide materials that comply with the applicable requirements.

Aggregate	15-PS0168
Admixtures and Plasticizers	DIVISION 1400
Grade 2 Calcium Chloride	DIVISION 1700
Cement, Fly Ash, Silica Fume, Slag Cement and Blended Supplemental Cementitious.....	DIVISION 2000
Water	DIVISION 2400

401.3 CONCRETE MIX DESIGN

a. General. Design the concrete mixes specified in the contract documents.

Do not place any concrete on the project until the engineer approves the concrete mix designs.

Take full responsibility for the actual proportions of the concrete mix, even if the engineer assists in the design of the concrete mix.

Provide aggregate gradations that comply with **DIVISION 1100** and contract documents.

Admixture dosage rate requirements for mix design approval and field production are provided in **subsection 401.3l**.

If desired, contact the DME for available information to help determine approximate proportions to produce concrete having the required characteristics on the project.

Submit all concrete mix designs to the engineer for review and approval. Submit completed volumetric mix designs on KDOT Form No. 694 and all required attachments at least 60 days prior to placement of concrete on the project. The engineer will provide an initial review of the design within 5 business days following submittal.

Include the following information:

- (1) Test data from KT-73 tested at 28 days, KT-79 tested at 28 days **or** AASHTO T-277 tested at 56 days. Provide test results on a minimum of one set of three cylinders for each mix, tested at the highest water to cementitious material ratio that meets **subsections 401.3e** and **401.3i**. Submit accelerated cure procedures for the engineer's approval.
- (2) Test data from ASTM C 1567 for blended cements meeting **subsection 401.3k** for all concrete utilizing all actual materials proposed for use on the project at designated percentages.
- (3) Single point grading for the combined aggregates along with a plus/minus tolerance for each sieve. Use plus/minus tolerances to perform quality control checks and by the engineer to perform aggregate grading verification testing. The tests may be performed on the combined materials or on individual aggregates, and then theoretically combined to determine compliance.
- (4) Laboratory 28-day compressive strength test results on a minimum of 1 set of three cylinders produced from the mix design with the highest water to cementitious ratio for the project, utilizing all actual materials

proposed for use on the project at designated percentages. The average compressive strength shall exceed the strength requirements for the Grade (see **subsection 401.3e.** for Grade definitions) specified in the contract documents as determined by **subsection 401.3b.** Perform compressive strength tests according to KT-76.

- (5) Historical mix production data for the plant producing concrete for the project to substantiate the standard deviation selected for use in **subsection 401.3b.**, if applicable.
- (6) Necessary materials to enable the engineer to test the mix properties, if applicable.
- (7) Batching sequence. Consider the location of the concrete plant in relation to the job site and identify when and at what location the water reducer or plasticizer is added to the concrete mixture.

Submit complete mix design data including proportions and sources of all mix ingredients, and the results of strength and permeability tests representing the mixes proposed for use. The data may come from previous KDOT project records, or a laboratory regularly inspected by Cement and Concrete Reference Laboratory (CCRL). Data from other sources will only be accepted if testing was conducted by personnel certified in Hardened Concrete Properties (HCP) according to the Policy and Procedures Manual for The Certified Inspection and Testing (CIT) Training Program.

After initial review, the engineer will perform any testing necessary to verify the design. This may include a three cubic yard test batch at the producing plant. Do not make changes to the Approved Concrete Mix Design without the engineer's approval. Limited adjustments may be made to admixture dosages and aggregate proportions in accordance with **subsection 401.3j.** and **subsection 403.4e.**

Mix designs will remain approved when verification testing for strength and permeability conducted within the last 12 months indicate continued compliance with the specifications and percentages of constituents including aggregate and cementitious materials and product, type and

supplier of admixtures remain the same. Test results on the same mix from other sources are acceptable.

Improvements in concrete strength, workability, durability and permeability are possible if the combined aggregate grading is optimized. Procedures found in ACI 302.1 or other mix design techniques, approved by the engineer, are acceptable in optimizing the mix design.

Delay the commencement of tests for temperature, slump, and air content and molding of field cylinders from 4 to 4½ minutes after the sample has been taken from a continuous mixer. If a batch type mixer is used, take the tests at the point of placement and begin testing immediately.

b. Required Compressive Strength for Mix Design. The required compressive strength for mix design approval shall be based on previous data or **subsection 401.3b.(2)**.

(1) Concrete Mix Design Based on Previous Data. Provide concrete mix designs based on previous 28-day compressive strength test data from similar concrete mixtures. Similar mixtures are within 1000 psi of the specified 28-day compressive strength and are produced with the same type and sources of cementitious materials, admixtures, and aggregates.

Consider sand sources the same, provided they are not more than 25 miles apart on the same river and no tributaries enter the river between the two points. Consider crushed locations similar if they are mined in one continuous operation, and there is no significant change in geology. Mixes that have changes of more than 10% in proportions of cementitious materials, aggregates or water content are not considered similar.

Air entrained mixes are not considered similar to non-air entrained mixes.

Mixes tested with admixtures are not the same as mixes tested without those admixtures.

Test data should represent at least 30 separate batches of the mix. One set of data is the average of at least two cylinders from the batch. The data shall represent a minimum of 45 days of production within the past 12 months.

Do not include data over one year old. When fewer than 30 data sets are available, the standard deviation of the data must be corrected to compensate for the fewer data points.

Provide a concrete mix design that will permit no more than 5% of the 28-day compressive strength tests to fall below the specified 28-day compressive strength ($f'c$) based on equation A,

and no more than 1% of the 28-day compressive strength tests to fall below the specified 28-day compressive strength ($f'c$) by more than 500 psi based on equation B.

$$f'cr = f'c + 1.62 * k * s$$

Equation A

$$f'cr = (f'c - 500) + 2.24 * k * s$$

Equation B

Where: $f'cr$ = average 28-day compressive strength required to meet the above criteria.

$f'c$ = specified 28-day compressive strength

s = standard deviation of test data

k = constant based on number of data points

n = number of data points

$k = 1.3 - n / 100$, where $15 < n < 30$

$k = 1$, where $n > 30$

Provide a concrete mix design that has an average compressive strength that is equal to the larger of Equation A or Equation B. Submit all supporting test data with the mix design.

(2) All other concrete mix designs. For concrete mixes that have fewer than 15 data points, or if no statistical data is available, use Equations A and B to calculate $f'cr$ using the following values.

$s = 20\%$ of the specified 28-day compressive strength ($f'c$)

$k = 1$

c. Portland Cement and Blended Hydraulic Cement. Unless specified otherwise in the Contract Documents, select the type of portland cement or blended hydraulic cement according to **TABLE 401-1**.

TABLE 401-1: PORTLAND CEMENT & BLENDED HYDRAULIC CEMENT	
Concrete for:	Type of Cement Allowed
On Grade Concrete	Type IP(x) Portland-Pozzolan Cement Type IS(x) Portland- Slag Cement Type IT(Ax)(By) Ternary Blended Cement Type IL(x) Portland-Limestone Cement Type II Portland Cement
All Concrete other than On Grade Concrete	Type I Portland Cement Type IP(x) Portland-Pozzolan Cement Type IS(x) Portland- Slag Cement Type IT(Ax)(By) Ternary Blended Cement Type IL(x) Portland Limestone Cement Type II Portland Cement
High Early Strength Concrete	Type III Portland Cement Type I, IP(x), IS(x), IT(Ax)(By), Type IL(x) or II Cement may be used if strength and time requirements are met.

d. Blended Cement Concrete. When approved by the engineer, the concrete mix design may include SCMs such as fly ash, slag cement, silica fume or blended SCM from an approved source as a partial replacement for portland cement or blended hydraulic cement except where controlled by **15-PS0167 and SECTIONS 403 and 404**. Obtain the engineer’s approval before substituting SCMs for Type III cement. Changes in SCM or cement will require a new mix design approval.

- (1) Cements meeting **SECTION 2001** are not field blended cements.
- (2) Cements with SCMs added at the concrete mixing plant are field blended cements.
- (3) Supplementary materials can be combined with cement to create field blended cements. Do not exceed allowable substitution rates noted in **TABLE 401-2**. Substitute 1 pound of SCM for 1 pound of cement.
- (4) SCMs in prequalified cements are to be included in the total combined substitution rate.

TABLE 401-2: ALLOWABLE SUBSTITUTION RATE FOR SUPPLEMENTARY CEMENTITIOUS MATERIAL	
Material	Substitution Rate*
Slag Cement	40% Maximum
Fly Ash	25% Maximum
Blended SCM	25% Maximum
Limestone	10% Maximum
Silica Fume	5% Maximum
Total Combined	50%

*Total Substitution Rate includes material in preblended cements and blended SCMs.

- (5) When used, add silica fume with other cementitious materials during batching procedures. If the silica fume cannot be added to the cementitious materials, add the loose silica fume to the bottom of the stationary drum that is wet, but has no standing water, before adding the dry materials. The engineer may approve shreddable bags on a performance basis and only when a central batch mixing process is used. If so, add the bags to half of the mixing water and mix before adding cementitious materials, aggregate and remainder of water.

Mix silica fume modified concrete for a minimum of 100 mixing revolutions.

e. Strength. Design concrete to meet **TABLE 401-3**.

TABLE 401-3: CONCRETE STRENGTH REQUIREMENTS	
Specified 28-Day Compressive Strengths, minimum, psi	
<i>f'c</i>	
Grade of Concrete:	Non-Air Entrained/Air Entrained Concrete
Grade 7.0	7,000
Grade 6.0	6,000
Grade 5.0	5,000
Grade 4.5	4,500
Grade 4.0	4,000
Grade 3.5	3,500
Grade 3.0	3,000
Grade 2.5	2,500

f. High Early Strength Concrete (HESC). Design the high early strength concrete mix to comply with strength and time requirements specified in the contract documents.

Unless otherwise specified, design high early strength concrete for pavement at a minimum of one of the contractor's standard deviations above 2400 psi (cylinders) at 24 hours. If no statistics are available, design a HESC with a compressive strength greater or equal to 2880 psi.

Submit complete mix design data including proportions and sources of all mix ingredients, and the results of time and strength tests representing the mixes proposed for use. The strength and time data may come from previous KDOT project records or from an independent laboratory and shall equal or exceed the strength and time requirements listed in the contract documents.

g. Internally Cured Concrete (IC). The proportions of the internally cured concrete mix shall be determined by modifying the proportions of a conventional normal weight concrete mix. Replace a portion of the normal weight fine aggregate with prewetted lightweight fine aggregate. The weight of prewetted lightweight aggregate (W_{LWA}) required to supply internal curing water shall be calculated using equation C.

$$W_{LWA} = 0.07 \times (\text{total weight of cementitious material}) \times (1 + \text{absorption}) / ((\text{absorption}) \times (\text{desorption}))$$

Equation C

Where: the total weight of cementitious materials is expressed in pounds, the absorption and desorption values are expressed as decimal fractions, and the absorption and desorption values used to compute W_{LWA} shall be for the specific source of aggregate selected for use in the internally cured concrete. Absorption and Desorption Values to be determined and supplied by aggregate producer.

For guidance on computing W_{LWA} , see the [ESCSI Guide for Calculating the Quantity of Prewetted ESCS Lightweight Aggregates for Internal Curing \(IC Calculator\)](http://escsi.org) at escsi.org. The volume of prewetted lightweight aggregate that corresponds to W_{LWA} shall replace an equal volume of normal weight fine aggregate.

Submit the internally cured concrete mix designs in accordance with **subsection 401.3a** including the absorption and desorption values for the selected source of lightweight aggregate. Mix designs for internally cured concrete shall be considered as approximate until verifying the absorption of the lightweight aggregate (to establish the amount of internal curing water) 24 hours prior to batching.

Changes in mixture proportions for lightweight aggregate based on the absorption measured 24 hours prior to batching shall be made as a replacement of normal weight fine aggregate. Samples shall be obtained in accordance with KT-01. Use a centrifuge to place the lightweight aggregate in a prewetted surface dry condition for testing.

h. Slump. Designate a slump for each concrete mix design that is required for satisfactory placement of the concrete application not to exceed 5 in. except where controlled by maximum allowable slumps stated in **15-PS0167 and SECTIONS 403 and 404**. Reject concrete with a slump that limits the workability or placement of the concrete.

i. Permeability. Supply concrete meeting the permeability requirements specified in **15-PS0167** for structural concrete and **SECTION 403** for on grade concrete. Permeability testing from KT-73 tested at 28 days, KT-79 tested at 28 days **or** AASHTO T-277 tested at 56 days is required for all bridge overlays, Moderate Permeability Concrete, and any project with over 250 cubic yards of concrete (this includes structural concrete, on grade concrete etc.). The field verification test procedure must be the same test procedure as the mix design approval test.

There are no permeability requirements for concrete for prestressed concrete members as specified in **SECTION 404**.

j. Air Content. Determine air content by KT-18 (Pressure Method) or KT-19 (Volumetric Method). With **the exception of LC-HPC** as shown in **15-PS0167** and pavement as shown in **SECTION 403**, use the middle of the specified air content range of $6.5 \pm 1.5\%$ for the design of air entrained concrete. Maximum air content is 10%. Take immediate steps to reduce the air content whenever the air content exceeds 8%.

k. Alkali Silica Reactivity. If the concrete mix design includes supplemental cementitious materials (SCMs), provide mortar expansion test results from ASTM C 1567 as part of mix design approval unless meeting the minimum requirements shown in **TABLE 401-4**. Use the project's mix design concrete materials at their designated percentages. Provide a mix with a maximum expansion of 0.10% at 16 days after casting. Provide ASTM C 1567 results on an annual basis.

TABLE 401-4: MINIMUM SCM CONTENT REQUIRED TO WAIVE ASTM C 1567 TESTING				
Type of Coarse Aggregate Sweetener	Proportion Required by Percent Weight of Total Cementitious Material			
	Slag Cement	Class C Fly Ash	Class F Fly Ash	Silica Fume
Crushed Sandstone	ASTM C 1567 Testing Required		25%	Any*
Crushed Limestone or Dolomite			25%	Any*
Siliceous Aggregate Meeting subsection 1102.2a.(2) or 1116.2a.(2)			25%	Any*
Any combination of Limestone (or Dolomite or Sandstone) and Siliceous Aggregate meeting subsection 1102.2a.(2) or 1116.2a.(2) or any TMA	Any*	≥15%	Any*	Any*

*Subject to the maximum allowable percentages in **TABLE 401-2**.

ASTM C 1567 Testing can be waived for ternary mix designs with approval of the KDOT Bureau of Research.

l. Admixtures for Acceleration, Air-Entraining, Plasticizing, Set Retardation and Water Reduction. Verify that the admixtures used are compatible and will work as intended without detrimental effects. Use the dosages recommended by the admixture manufacturers. Incorporate and mix the admixtures into concrete mixtures according to the manufacturer's recommendations. Determine the quantity of each admixture for the concrete mix design.

- (1) Accelerating Admixture. When specified in the Contract Documents, or in situations that involve contact with reinforcing steel and require early strength development to expedite opening to traffic, a non-chloride accelerator may be approved. The Engineer may approve the use of a Type C or E accelerating admixture. A Grade 2 calcium chloride

accelerator may be used when patching an existing pavement more than 10 years old.

Add the calcium chloride by solution (the solution is considered part of the mixing water).

- For a minimum cure of 4 hours at 60 °F or above, use 2% (by dry weight of cement) calcium chloride.
- For a minimum cure of 6 hours at 60 °F or above, use 1% (by dry weight of cement) calcium chloride.

(2) Air-Entraining Admixture. When specified, use an air-entraining admixture in the concrete mixture. If another admixture is added to an air-entrained concrete mixture, determine if it is necessary to adjust the air-entraining admixture dosage to maintain the specified air content.

(3) Water-Reducers and Set-Retarders. A water-reducing admixture for improving workability may be required. If unfavorable weather or other conditions adversely affect the placing and finishing properties of the concrete mix, the engineer may allow the use of water-reducers and set-retarders. Verify that the admixtures will work as intended without detrimental effects. If the engineer approves the use of water-reducers and set-retarders, their continued use depends on their performance.

(4) Plasticizer Admixture. A plasticizer is defined as an admixture that produces flowing concrete, without further addition of water, and/or retards the setting of concrete. Flowing concrete is defined as having a slump equal to or greater than 7 ½ in. while maintaining a cohesive nature.

Manufacturers of plasticizers may recommend mixing revolutions beyond the limits specified in **subsection 401.8**. If necessary, address the additional mixing revolutions in the concrete mix design. The engineer may allow up to 60 additional revolutions when plasticizers are designated in the mix design.

Before the concrete mixture with a slump equal to or greater than 7 ½ in. is used on the project, conduct tests on at least one full trial batch of the concrete mix design in the presence of the engineer to determine the adequacy of the dosage and the batching sequence of the plasticizer to obtain the desired properties. Determine the air content of the trial batch both before and after the addition of the plasticizer. Monitor the slump, air content, temperature, and workability at regular intervals of the time period from when the plasticizer is added until the estimated time of completed placement. At the discretion of the engineer, if all the properties of the trial batch remain within the specified limits, the trial batch may be used in the project.

Do not add water after plasticizer is added to the concrete mixture.

(5) Field Adjustment to Admixtures. Limited adjustments to the dosage rate of accelerators, set-retarders, water reducers, and air-entraining admixtures are permitted to compensate for environmental changes during placement without a new concrete mix design or trial batch. Test the concrete for temperature, air content, and slump whenever changes are made to the dosage rates to ensure continued compliance with the specifications. The allowable adjustments are based on the dose used in the Approved Concrete Mix Design and according to the following:

- Do not exceed the accelerator dosage used in the Approved Mix Design. The accelerator dosage may be reduced or eliminated as needed. Redosing accelerators is not permitted.
- The water reducer dosage used in the Approved Mix Design sets the minimum permitted dose for use in the field. The water reducer dose may be increased from that shown in the Approved Mix Design provided that the slump does not to exceed the maximum designated slump. Slump reduction may be obtained by withholding a portion of the mix water as specified in **subsection 401.8a**.
- Redosing of water reducers and air-entraining admixtures is permitted to control slump or air content in the field, when approved by the Engineer, time and temperature limits are not exceeded, and at least 30

mixing revolutions remain before redosing. Redose according to manufacturer's recommendations.

- Set retarders may be added as needed during production. Do not include set retarders in the mix submitted for Mix Design Approval. Redosing retarders is not permitted. Paperwork for submitted mix designs (Form 694) with no (zero) water reducer and/or set retarder in the original concrete submitted for mix design approval must show the manufacturer of the admixtures that may be included in the project concrete.

401.4 REQUIREMENTS FOR COMBINED MATERIALS

a. Measurements for Proportioning Materials.

- (1) Cement. Measure cement as packed by the manufacturer. A sack of cement is considered as 0.04 cubic yards weighing 94 lbs net. Measure bulk cement by weight. In either case, the measurement must be accurate to within 0.5% throughout the range of use.
- (2) Supplemental Cementitious Materials. Supplemental cementitious materials proportioning and batching equipment is subject to the same controls as required for cement. Provide positive cut off with no leakage from the cut off valve. Cementitious materials may be weighed accumulatively with the cement or separately. If weighed accumulatively, weigh the cement first.
- (3) Water. Measure the mixing water by weight or by volume accurate to within 1% throughout the range of use.
- (4) Aggregates. Measure the aggregates by weight, accurate to within 0.5% throughout the range of use.
- (5) Admixtures. Measure liquid admixtures by weight or volume, accurate to within 3% of the quantity required. If liquid admixtures are used in small quantities in proportion to the cement as in the case of air-entraining agents, use readily adjustable mechanical dispensing

equipment capable of being set to deliver the required quantity and to cut off the flow automatically when this quantity is discharged.

b. Testing of Aggregates.

- (1) Production of On Grade Concrete Aggregate (OGCA). If OGCA is required, notify the Engineer in writing at least two weeks in advance of producing the aggregate. Include the source of the aggregate and the date production will begin. Failure to notify the engineer, as required, may result in rejection of the aggregate for use as OGCA. Maintain separate stockpiles for OGCA at the quarry and at the batch site and identify them accordingly.
- (2) Testing Aggregates at the Batch Site. Provide the engineer with reasonable facilities at the batch site for obtaining samples of the aggregates. Provide adequate and safe laboratory facilities at the batch site allowing the engineer to test the aggregates for compliance with the specified requirements.

KDOT will sample and test aggregates from each source to determine their compliance with specifications. Do not batch the concrete mixture until the engineer has determined that the aggregates comply with the specifications. KDOT will conduct sampling at the batching site, and test samples according to the Sampling and Testing Frequency Chart in Part V. For QC/QA contracts, establish testing intervals within the specified minimum frequency.

After initial testing is complete, and the engineer has determined that the aggregate process control is satisfactory, use the aggregates concurrently with sampling and testing as long as tests verify compliance with specifications. When batching, sample the aggregates as near the point of batching as feasible. Sample from the stream as the storage bins or weigh hoppers are loaded. If samples cannot be taken from the stream, take them from approved stockpiles, or use a template and sample from the conveyor belt. If test results indicate an aggregate does not comply with specifications, cease concrete production using that aggregate. Unless a tested and approved stockpile for that aggregate is available at the batch plant, do not use any additional aggregate from

that source and specified grading until subsequent testing of that aggregate indicate compliance with specifications. When tests are completed and the engineer is satisfied that process control is satisfactory, production of concrete using aggregates tested concurrently with production may resume.

c. Handling of Materials.

- (1) Approved stockpiles are permitted only at the batch plant and only for small concrete placements or for maintaining concrete production. Mark the approved stockpile with an "Approved Materials" sign. Provide a suitable stockpile area at the batch plant so that aggregates are stored without detrimental segregation or contamination. At the plant, limit stockpiles of tested and approved coarse, fine and intermediate aggregate to 250 tons each, unless approved for more by the engineer. If mixed aggregate is used, limit the approved stockpile to 500 tons, the size of each being proportional to the amount of each aggregate to be used in the mix.

Load aggregates into the mixer such that no material foreign to the concrete or material capable of changing the desired proportions is included.

- (2) Segregation. Do not use segregated aggregates. Previously segregated materials may be thoroughly re-mixed and used when representative samples taken anywhere in the stockpile indicated a uniform gradation exists.
- (3) Cement and Supplemental Cementitious. Protect cement and supplemental cementitious materials in storage or stockpiled on the site from any damage by climatic conditions which would change the characteristics or usability of the material.
- (4) Moisture. Provide aggregate with a moisture content of $\pm 0.5\%$ from the average of that day. If the moisture content in the aggregate varies by more than the above tolerance, take whatever corrective measures are

necessary to bring the moisture to a constant and uniform consistency before placing concrete. This may be accomplished by handling or manipulating the stockpiles to reduce the moisture content, or by adding moisture to the stockpiles in a manner producing uniform moisture content through all portions of the stockpile.

Handheld moisture-determining devices are permitted. For plants equipped with an approved accurate moisture-determining device capable of continuously determining the free moisture in the aggregates, and provisions made for batch-to-batch correction of the amount of water and the weight of aggregates added, the requirements relative to manipulating the stockpiles for moisture control will be waived. Approval and accuracy of the moisture-determining device is based on daily comparisons with KT-24 or ASTM C 566 and at the discretion of the engineer. Any procedure used will not relieve the producer of the responsibility for delivering concrete of uniform slump within the limits specified.

- (5) Separation of Materials in Tested and Approved Stockpiles. Only use KDOT approved materials. Provide separate means for storing materials approved by KDOT. If the producer elects to use KDOT approved materials for non-KDOT work, during the progress of a project requiring KDOT approved materials, inform the engineer and agree to pay all costs for additional material testing.

Clean all conveyors, bins, and hoppers of any unapproved materials before beginning the manufacture of concrete for KDOT work.

- (6) Prewetted Lightweight Fine Aggregate Stockpiles. The lightweight aggregate shall be stockpiled and handled in accordance with **DIVISION 1100** to ensure that the target absorbed moisture content has been achieved at the time of batching. Batch weights for lightweight aggregate shall be adjusted based on the amount of free moisture determined within one hour of batching.

401.5 MORTAR AND GROUT

a. General. Follow the proportioning requirements in **subsections 401.5b.** and **c.** for mortar and grout unless otherwise specified in the contract documents, including altering the proportions when a minimum strength is specified.

b. Mortar. Mortar is defined as a mixture of cementitious materials, FA-M aggregate and water, which may contain admixtures, and is typically used to minimize erosion between large stones or to bond masonry units.

Proportion mortar for laying stone for stone rip-rap, slope protection, stone ditch lining or pavement patching at one part of portland cement and three parts of FA-M aggregate by volume with sufficient water to make a workable and plastic mix.

Proportion mortar for laying brick, concrete blocks or stone masonry at half part masonry cement, half part portland cement and three parts FA-M aggregate, either commercially produced masonry sand or FA-M, by volume with sufficient water to make a workable and plastic mix.

Do not use air-entraining agents in mortar for masonry work.

The engineer may visually accept the sand used for mortar. The engineer may visually accept any recognized brand of portland cement or masonry cement that is free of lumps.

c. Grout. Grout is defined as a mixture of cementitious materials with or without aggregate or admixtures to which sufficient water is added to produce a pouring or pumping consistency without segregation of the constituent materials and meeting the applicable specifications.

401.6 COMMERCIAL GRADE CONCRETE

If the Contract Documents allow the use of commercial grade concrete for designated items, then use a commercial grade mixture from a ready-mix plant approved by the engineer.

The engineer must approve the commercial grade concrete mixture. Approval of the commercial grade mixture is based on these conditions:

- All materials are those normally used for the production and sale of concrete in the vicinity of the project.

- The mixture produced is that normally used for the production and sale of concrete in the vicinity of the project.
- The mixture produced contains a minimum cementitious content of six sacks (564 lbs) of cementitious material per cubic yard of concrete.
- The water-cementitious ratio is as designated by the engineer. The maximum water-cementitious ratio permitted may not exceed 0.50 lbs of water per pound of cementitious material including free water in the aggregate.
- Type I, II, III, IP, IS or IT cement may be used unless otherwise designated. Fly ash, slag cement and blended supplemental materials may be substituted for the required minimum cement content as specified in **subsection 401.3**. No additives other than air entraining agent will be allowed. The contractor will not be required to furnish the results of strength tests when submitting mix design data to the engineer.
- In lieu of the above, approved mix designs (including optimized) for all other grades of concrete, Grade 3.0 or above, are allowable for use as commercial grade concrete, at no additional cost to KDOT.

Exercise good engineering judgment in determining what equipment is used in proportioning, mixing, transporting, placing, consolidating, and finishing the concrete.

Construct the items with the best current industry practices and techniques.

Before unloading at the site, provide a delivery ticket for each load of concrete containing the following information:

- Name and location of the plant.
- Time of batching concrete.
- Mix proportions of concrete (or a mix designation approved by the engineer).
- Number of cubic yards of concrete batched.

Cure the various items placed, as shown in **DIVISION 700 and 15-PS0165**.

The engineer may test commercial grade concrete by molding sets of three cylinders. This is for informational purposes only. No slump or unit weight tests are required.

401.7 CERTIFIED CONCRETE

If KDOT inspection forces are not available on a temporary basis, the engineer may authorize the use of concrete from approved concrete plants. Approval for this operation is based on certification of the plant and plant personnel, according to KDOT standards. KDOT's approval may be withdrawn any time that certification procedures are not followed. Contact the DME for additional information.

The engineer will not authorize the use of certified concrete for major structures such as bridges, RCB box bridges, RCB culverts, permanent main line and ramp pavement or other structurally critical items.

Each load of certified concrete must be accompanied by a ticket, listing mix proportions, time of batching and setting on revolution counter, total mixing revolutions, and must be signed by certified plant personnel.

401.8 MIXING, DELIVERY AND PLACEMENT LIMITATIONS

a. Concrete Batching, Mixing and Delivery. Batch and mix the concrete in a central mix plant, in a truck mixer or in a drum mixer at the work site. Provide plant capacity and delivery capacity sufficient to maintain continuous delivery at the rate required. The delivery rate of concrete during concreting operations must provide for the proper handling, placing, and finishing of the concrete.

Seek the engineer's approval of the concrete plant/batch site before any concrete is produced for the project. The engineer will inspect the equipment, the method of storing and handling of materials, the production procedures, the transportation, and rate of delivery of concrete from the plant to the point of use. The engineer will grant approval of the concrete plant/batch site based on compliance with the specified requirements. The engineer may, at any time, rescind permission to use concrete from a previously approved concrete plant/batch site upon failure to comply with the specified requirements.

Clean the mixing drum before it is charged with the concrete mixture. Charge the batch into the mixing drum such that a portion of the water is in the drum before the aggregates and cementitious material. Uniformly flow materials into the drum throughout the batching operation. All mixing water must be in the drum by the end of the first 15 seconds of the mixing cycle. Keep the throat of the drum free of accumulations restricting the flow of materials into the drum.

Do not exceed the rated capacity (cubic yards shown on the manufacturer's plate on the mixer) of the mixer when batching the concrete. The engineer may allow an overload of up to 10% above the rated capacity for central mix plants and drum mixers at the work site, provided the concrete test data for strength, segregation, and uniform consistency are satisfactory, and no concrete is spilled during the mixing cycle.

Operate the mixing drum at the speed specified by the mixer's manufacturer (shown on the manufacturer's plate on the mixer).

Mixing time is measured from the time all materials, except water, are in the drum. If it is necessary to increase the mixing time to obtain the specified percent of air in air-entrained concrete, the Engineer will determine the mixing time.

If the concrete is mixed in a central mix plant or a drum mixer at the work site, mix the batch between 1 to 5 minutes at mixing speed. Do not exceed the maximum total 60 mixing revolutions. Mixing time begins after all materials, except water, are in the drum, and ends when the discharge chute opens. Transfer time in multiple drum mixers is included in mixing time. Mix time may be reduced for plants utilizing high performance mixing drums provided thoroughly mixed and uniform concrete is being produced with the proposed mix time. Performance of the plant must conform to Table A1.1 of ASTM C 94, Standard Specification for Ready Mixed Concrete. Five of the six tests listed in Table A1.1 must be within the limits of the specification to indicate that uniform concrete is being produced.

If the concrete is mixed in a truck mixer, mix the batch between 70 and 100 revolutions of the drum or blades at mixing speed. After the mixing is completed, set the truck mixer drum at agitating speed. Unless the mixing unit is equipped with an accurate device indicating and controlling the number of revolutions at mixing speed, perform the mixing at the batch plant and operate the mixing unit at agitating speed while travelling from the plant to the work site. Do not

exceed 300 total revolutions (mixing and agitating). An additional 60 mixing revolutions may be allowed by the engineer when plasticizers are designated in the mix design.

If a truck mixer or truck agitator is used to transport concrete that was completely mixed in a stationary central mixer, agitate the concrete while transporting at the agitating speed specified by the manufacturer of the equipment (shown on the manufacturer's plate on the equipment). Do not exceed 200 total revolutions (additional re-mixing and agitating).

Provide a batch slip including batch weights of every constituent of the concrete and time for each batch of concrete delivered at the work site, issued at the batching plant that bears the time of charging of the mixer drum with cementitious materials and aggregates. Include quantities, type, product name and manufacturer of all admixtures on the batch ticket.

On paving projects and other high-volume work, the engineer will evaluate the haul time, and whether tickets will be collected for every load. Thereafter, random checks of the loads will be made. Maintain all batch tickets when not collected.

When non-agitating equipment is used for transportation of concrete, place within 30 minutes of adding the cement to the water. Provide approved covers for protection against the weather when required by the engineer.

When agitating equipment is used for transportation of the concrete, place concrete within the time and temperature conditions shown in **TABLE 401-5**.

TABLE 401-5: AMBIENT AIR TEMPERATURE AND AGITATED CONCRETE PLACEMENT TIME		
T = Ambient Air Temperature at Time of Batching (°F)	Time limit agitated concrete must be placed within, after the addition of cement to water (hours)	Admixtures
T < 75	1 ½	All Cases
75 ≤ T < 90	1	None
75 ≤ T < 90	1 ½	Set Retarder
90 ≤ T	¾ (45 minutes)	All Cases

Do not use concrete that has developed its initial set. Regardless of the speed of delivery and placement, the engineer will suspend the concreting operations until corrective measures are taken, if there is evidence that the concrete cannot be adequately consolidated.

Weather conditions and the use of admixtures can affect the set times for the concrete. Do not use the time limits and total revolutions as the sole criterion for rejection of concrete. Exceed the time limits and total revolutions only after demonstrating that the properties of the concrete can be improved. An evaluation of the consistency and workability should be taken into consideration. Reject concrete that cannot be adequately consolidated.

Adding water to concrete after the initial mixing is prohibited, with this exception:

If the concrete is delivered to the work site in a truck mixer, the engineer will allow water (up to two gallons per cubic yard) be withheld from the mixture at the batch site, and if needed, added at the work site to adjust the slump to the specified requirements. Determine the need for additional water as soon as the load arrives at the construction site. Use a calibrated water-measuring device to add the water and add the water to the entire load. Do not add more water than was withheld at the batch site. After the additional water is added, turn the drum or blades an additional 20 to 30 revolutions at mixing speed. The engineer will supervise the adding of water to the load and will allow this procedure only once per load. Conduct all testing for acceptance and produce any required cylinders after all water or admixtures have been added.

Do not add water at the work site if the slump is within the designated slump tolerance, even if water was withheld.

Do not add water at the work site if the percent air is above 8%, regardless of the slump, even if water was withheld.

Do not withhold and add water if plasticizer is added to the concrete mixture at the batch site.

If at any time during the placement of concrete it is determined that redosing with water is adversely affecting the properties of the concrete, the concrete will be rejected, and the engineer will suspend the practice.

b. Placement Limitations.

- (1) Concrete Temperature. Unless otherwise authorized by the engineer, the temperature of the mixed concrete immediately before placement is a minimum of 50 °F and a maximum of 90 °F. The maximum concrete temperature for LC-HPC is 80 °F. Maintain the temperature of the

concrete at time of placement within the specified temperature range by any combination of the following:

- Shading the materials storage areas or the production equipment.
- Cooling the aggregates by sprinkling with potable water.
- Cooling the aggregates or water by refrigeration or replacing a portion or all of the mix water with ice that is flaked or crushed to the extent that the ice will completely melt during mixing of the concrete.
- Liquid nitrogen injection.

(2) Qualification Batch. For LC-HPC, qualify a field batch (one truckload or at least six cubic yards) at least 60 days prior to commencement of placement of the bridge decks. Produce the qualification batch from the same plant that will supply the concrete for the job. Simulate haul time to the jobsite prior to discharge of the concrete for testing. Prior to placing concrete in the qualification slab and on the job, submit documentation to the engineer verifying that the qualification batch concrete meets the requirements for air content, slump, temperature of plastic concrete, compressive strength, unit weight and other testing as required by the engineer.

Before the concrete mixture with plasticizing admixture is used on the project, determine the air content of the qualification batch. Monitor the slump, air content, and temperature at initial batching and estimated time of concrete placement. If these properties are not adequate, repeat the qualification batch until it can be demonstrated that the mix is within acceptable limits as specified in this specification. Once the LC-HPC has passed these plastic requirements, 11 4 in. × 8 in. cylinders will be cast by KDOT to determine permeability (RCPT, surface resistivity, and volume of permeable pores) and spacing factor.

(1) Placing Concrete at Night. Do not mix, place, or finish concrete without sufficient natural light, unless an adequate, artificial lighting system approved by the engineer is provided.

(2) Placing Concrete in Cold Weather. Unless authorized by the engineer, discontinue mixing and concreting operations when the descending ambient air temperature reaches 40 °F. Do not begin concreting operations until an ascending ambient air temperature reaches 35 °F and is expected to exceed 40 °F.

If the engineer permits placing concrete during cold weather, aggregates may be heated by either steam or dry heat system before placing them in the mixer. Use an apparatus that heats the mass uniformly and is so arranged as to preclude the possible occurrence of overheated areas which might injure the materials. Do not heat aggregates directly by gas or oil flame or on sheet metal over fire. Aggregates that are heated in bins, by steam-coil or water-coil heating, or by other methods not detrimental to the aggregates may be used. The use of live steam on or through binned aggregates is prohibited. Unless otherwise authorized, maintain the temperature of the mixed concrete between 50 to 90 °F at the time of placing. Do not, under any circumstances, continue concrete operations if the ambient air temperature is less than 20 °F.

If the ambient air temperature is 35 °F or less at the time the concrete is placed, the engineer may require that the water and the aggregates be heated to between 70 and 150 °F.

Do not place concrete on frozen subgrade or use frozen aggregates in the concrete.

Make adjustments for potential longer set time and slower strength gain for concrete with SCMs. Adjust minimum time requirements as stated in **15-PS0165** for concrete used in structures. For concrete paving, be aware of the effect that the use of SCMs (except silica fume) may have on the statistics and moving averages.

401.9 INSPECTION AND TESTING

Unless otherwise designated in the contract documents or by the engineer, obtain samples of fresh concrete for the determination of slump, weight per cubic yard and percent of air from the final point of placement.

The engineer will cast, store, and test strength test specimens in sets of three.

KDOT will conduct the sampling and test the samples according to **DIVISION 2500** and the Sampling and Testing Frequency Chart in Part V. For QC/QA contracts, establish testing intervals within the specified minimum frequency.

The engineer will reject concrete that does not comply with specified requirements.

The engineer will permit occasional deviations below the specified cementitious content, if it is due to the air content of the concrete exceeding the designated air content, but only up to the maximum tolerance in the air content.

Continuous operation below the specified cementitious content for any reason is prohibited.

As the work progresses, the engineer reserves the right to require the contractor to change the proportions if conditions warrant such changes to produce a satisfactory mix. Any such changes may be made within the limits of the specifications at no additional compensation to the contractor.

**KANSAS DEPARTMENT OF TRANSPORTATION
SPECIAL PROVISION TO THE
STANDARD SPECIFICATIONS, EDITION 2015**

For Low-Cracking High-Performance Concrete, delete SECTION 1102 and replace with the following:

SECTION 1102

LOW-CRACKING HIGH-PERFORMANCE CONCRETE-AGGREGATES

1102.1 DESCRIPTION

This specification is for coarse aggregates, intermediate aggregates, fine aggregates, mixed aggregates (coarse, intermediate, and fine material), and miscellaneous aggregates for use in construction of concrete not placed on grade.

For intermediate aggregates and mixed aggregates, consider any aggregate with 30% or more retained on the No. 8 sieve to be coarse aggregate.

1102.2 REQUIREMENTS

a. Quality of Individual Aggregates.

- (1) Provide aggregates for concrete that comply with **TABLE 1102-1**. Crushed aggregates with less than 20% material retained on the 3/8" sieve must be produced from a source complying with these requirements prior to crushing. Fine aggregates for concrete have additional quality requirements stated in **subsection 1102.2e.(2)**. Requirements for lightweight aggregates for internally cured concrete are specified in **subsection 1102.2f.(2)(e)**.

TABLE 1102-1: QUALITY REQUIREMENTS FOR CONCRETE AGGREGATES				
Concrete Classification	Soundness (min.)	Wear (max.)	Absorption (max.)	Acid Insoluble⁵ (min.)
Grade xx (AE)(SW) ¹	0.90	40	-	-
Grade xx (AE)(SA) ²	0.90	40	2.0	-
Grade xx (AE)(AI) ³	0.90	40	-	85
Grade xx (AE)(PB) ⁴	0.90	40	3.0	-
Bridge Overlays	0.95	40	-	85
All Other Concrete	0.90	50	-	-

¹Grade xx (AE)(SW) - Structural concrete with select coarse aggregate for wear.

²Grade xx (AE)(SA) - Structural concrete with select coarse aggregate for wear and absorption.

³Grade xx (AE)(AI) - Structural concrete with select coarse aggregate for wear and acid insolubility.

⁴Grade xx (AE)(PB) - Structural concrete with select aggregate for use in prestressed concrete beams.

⁵Acid Insoluble requirement does not apply to calcite cemented sandstone.

- Soundness (KTMR-21) requirements do not apply to aggregates having less than 10% material retained on the No. 4 sieve.
- Wear (AASHTO T 96) requirements do not apply to aggregates having less than 10% retained on the No. 8 sieve.
- Absorption KT-6 Procedure I for material retained on the No. 4 sieve. Apply the maximum absorption to the portion retained on the No. 4 sieve.

(2) All predominately siliceous aggregate must comply with the Wetting & Drying Test requirements, or be used with a Coarse Aggregate Sweetener, or will require Supplemental Cementitious Materials (SCM) to prevent Alkali Silica Reactions (ASR). Refer to **15-PS0166 TABLE 401-4** to determine the need for ASTM C 1567 Testing. When required, provide the results of mortar expansion tests of ASTM C 1567 using the project's mix design concrete materials at their designated percentages. Provide a mix with a maximum expansion of 0.10% at 16 days after casting. Provide the results to the engineer at least 15 days before placement of concrete on the project.

Wetting & Drying Test of Siliceous Aggregate for Concrete (KTMR-23)

Concrete Modulus of Rupture:

- At 60 days, minimum 550 psi
- At 365 days, minimum 550 psi

Expansion:

- At 180 days, maximum 0.050%
- At 365 days, maximum 0.070%

Aggregates produced from the following general areas are exempt from the Wetting and Drying Test:

- Blue River Drainage Area.
- The Arkansas River from Sterling, west to the Colorado state line.
- The Neosho River from Emporia to the Oklahoma state line.

(3) Coarse Aggregate Sweetener. Types and proportions of aggregate sweeteners to be used with Mixed Aggregates are listed in **TABLE 1102-2**.

TABLE 1102-2: COARSE AGGREGATE SWEETENER	
Type of Coarse Aggregate Sweetener	Proportion Required by Percent Weight
Crushed Sandstone*	40 (minimum)
Crushed Limestone or Dolomite*	40 (minimum)
Siliceous Aggregates meeting subsection 1102.2a.(2)	40 (minimum)
Siliceous Aggregates not meeting subsection 1102.2a.(2) **	30 (maximum)

*Waive the minimum portion of Coarse Aggregate Sweetener for all intermediate and fine aggregates that comply with the wetting and drying requirements for Siliceous Aggregates. In this case, combine the intermediate, fine and coarse aggregate sweetener in proportions required to comply with the requirements of **subsection 1102.2a.(3)**

**To be used only with intermediate and fine aggregates that comply with the wetting and drying requirements of Siliceous Aggregates unless a Supplemental Cementitious Material is utilized.

(4) Deleterious Material. Maximum allowed deleterious substances by weight are:

- Clay lumps and friable particles (KT-7)..... 1.0%
- Coal (AASHTO T 113)..... 0.5%
- Shale or Shale-like material (KT-8)..... 0.5%
- Sticks (wet) (KT-35)..... 0.1%
- Total allowable deleterious..... 1.5%

b. Mixed Aggregates.

(1) Composition. Provide coarse, intermediate, and fine aggregates in a combination necessary to meet **subsection 1102.2b.(2)**. Use a proven optimization method such as ACI 302.1 or other method approved by the engineer. Aggregates may be from a single source or combination of sources.

(2) Product Control. Gradations such as those shown in **TABLE 1102-3** have proven satisfactory in reducing water demand while providing good workability. Adjust mixture proportions whenever individual aggregate grading varies during the course of the work. Use the gradations shown in **TABLE 1102-3**, or other gradation approved by the engineer.

Optimization is not required for Commercial Grade Concrete. The engineer may waive the optimization requirements if the concrete meets all the requirements of **DIVISION 400, 15-PS0166 and 15-PS0167**.

Follow these guidelines:

1. Do not permit the percent retained on two adjacent sieve sizes to fall below 4%;
2. Do not allow the percent retained on three adjacent sieve sizes to fall below 8%; and

3. When the percent retained on each of two adjacent sieve sizes is less than 8%, the total percent retained on either of these sieves and the adjacent outside sieve should be at least 13%, (for example, if both the No. 4 and No. 8 sieves have 6% retained on each, then:

- the total retained on the 3/8 in. and No. 4 sieves should be at least 13%, and
- the total retained on the No. 8 and No. 16 sieves should be at least 13%.)

TABLE 1102-3: ALLOWABLE GRADING FOR MIXED AGGREGATES FOR CONCRETE													
Type	Usage	Percent Retained - Square Mesh Sieves											
		1 1/2"	1"	3/4"	1/2"	3/8"	No. 4	No. 8	No. 16	No. 30	No. 50	No. 100	No. 200
MA-3	LC-HPC, and Optimized All Concrete		0	2-12	Note ¹	Note ¹	Note ¹	Note ¹	Note ²	Note ²	Note ²	95-100 ³	98-100 ⁴
MA-4	Optimized All Concrete*	0	2-12	Note ¹	Note ¹	Note ¹	Note ¹	Note ¹	Note ²	Note ²	Note ²	95-100 ³	98-100 ⁴
MA-5	Optimized Drilled Shafts		0	2-12	8 min	22-34		55-65		75 min		95-100	98-100
MA-6	Optimized for Bridge Overlays		0	0	2-12	Note ¹	Note ¹	Note ¹	Note ²	Note ²	Note ²	95-100 ³	98-100 ⁴
MA-7	Contractor Design KDOT Approved	Proposed Grading that does not correspond to other limits in this table but meet the requirements for concrete in DIVISION 400, 15-PS0166 and 15-PS0167.											98-100

*MA-4 is allowable on structures if the maximum aggregate size for reinforcing steel spacing and minimum cover are adhered to.

¹Retain a maximum of 22% (24% for MA-6) and a minimum of 6% of the material on each individual sieve.

²Retain a maximum of 15% and a minimum of 6% of the material on each individual sieve.

³Retain a maximum of 7% on the No. 100 sieve.

⁴Retain a maximum of 2% on the No. 200 sieve.

Optimization Requirements for all Gradations except MA-7.

- Actual Workability must be within ± 5 of Target Workability.

Where:

W_A = Actual Workability

W_T = Target Workability

CF = Coarseness Factor

1. Determine the Grading according to KT-2.
2. Calculate the Coarseness Factor (CF) to the nearest whole number.

$$CF = \frac{+3/8" \text{Material\% Retained}}{+ \#8 \text{Material\% Retained}} \times 100$$

3. Calculate the Actual Workability (W_A) to the nearest whole number as the percent material passing the #8 sieve.

$$W_A = 100 - \% \text{ retained on \#8 sieve}$$

4. Calculate the Target Workability (W_T) to the nearest whole number

Where For 517 lbs cement per cubic yard of concrete

$$W_T = 46.14 - (CF/6)$$

For each additional 1 lb of cement per cubic yard, subtract 2.5/94 from the Target Workability.

(c) Deleterious Substances. **Subsection 1102.2a.(4)**, as applicable.

(d) Uniformity of Supply. Designate or determine the fineness modulus (grading factor) for each aggregate according to the procedure listed Part V, Section 5.10.5 Fineness Modulus of Aggregates (Gradation Factor) before delivery, or from the first 10 samples tested and accepted. Provide aggregate that is within ± 0.20 of the average fineness modulus.

Provide a single point grading for the combined aggregates along with a plus/minus tolerance for each sieve. Use plus/minus tolerances to perform quality control checks and by the engineer to perform aggregate grading verification testing. The tests may be performed on the combined materials or on individual aggregates, and then, theoretically, combined to determine compliance.

(3) Handling of All Aggregates.

(a) Segregation. Before acceptance testing, remix all aggregate segregated by transit or stockpiling.

(b) Stockpiling.

- Maintain separation between aggregates from different sources, with different gradings or with a significantly different specific gravity.
- Transport aggregate in a manner that promotes uniform grading.
- Do not use aggregates that have become mixed with earth or foreign material.
- Stockpile or bin all washed aggregate produced or handled by hydraulic methods for 12 hours (minimum) before batching. Rail shipment exceeding 12 hours is acceptable for binning provided the car bodies permit free drainage.
- Provide additional stockpiling or binning in cases of high or non-uniform moisture.
- Stockpile accepted aggregates in layers 3 to 5 feet thick. Berm each layer so that aggregates do not "cone" down into lower layers.

c. Coarse Aggregates for Concrete.

- (1) Composition. Provide coarse aggregate that is crushed or uncrushed gravel or crushed stone meeting the quality requirements of **subsection 1102.2a**. Consider limestone, calcite cemented sandstone, rhyolite, quartzite, basalt, and granite as crushed stone.

Mixtures utilizing siliceous aggregate not meeting **subsection 1102.2a.(2)** will require supplemental cementitious materials to prevent Alkali Silica Reactions. Provide the results of mortar expansion tests of ASTM C 1567 using the project's mix design concrete materials at their designated percentages. Provide a mix with a maximum expansion of 0.10% at 16 days after casting. Provide the results to the engineer at least 15 days before placement of concrete on the project.

- (2) Product Control. Use gradations such as those in **TABLE 1102-4** which have been shown to work in optimized mixed aggregates, or some other gradation approved by the engineer that will provide a combined aggregate gradation meeting **subsection 1102.2b**.

TABLE 1102-4: ALLOWABLE GRADING FOR COARSE AGGREGATES									
Type	Composition	Percent Retained - Square Mesh Sieves							
		1½"	1"	¾"	½"	⅜"	No. 4	No. 8	No. 200
SCA-1	Siliceous Gravel or Crushed Stone	0	0-10	14-35	-	50-75	-	95-100	98-100
SCA-2	Siliceous Gravel or Crushed Stone			0	0-35	30-70	75-100	95-100	98-100
SCA-4	Siliceous Gravel or Crushed Stone		0	0-20				95-100	98-100

d. Intermediate Aggregate for Concrete.

- (1) Composition. Provide intermediate aggregate for mixed aggregates (IMA) that is crushed stone, natural occurring sand, or manufactured sand meeting the quality requirements of **subsection 1102.2a**.
- (2) Product Control. Provide IMA grading when necessary to provide a combined aggregate gradation meeting **subsection 1102.2b**.
- (3) Deleterious Substances. **Subsection 1102.2a.(4)**, as applicable.
- (4) Organic Impurities (AASHTO T 21). The color of the supernatant liquid is equal to or lighter than the reference standard solution.

e. Fine Aggregates for Concrete.

(1) Composition.

(a) Type FA-A. Provide either singly or in combination natural occurring sand resulting from the disintegration of siliceous or calcareous rock, or manufactured sand produced by crushing predominately siliceous materials meeting the quality requirements of **subsection 1102.2a**. and **1102.2e.(2)**.

(b) Type FA-C. Provide crushed siliceous aggregate, steel slag, or chat that is free of dirt, clay, and foreign or organic material.

(2) Additional Quality Requirements for FA-A.

(a) Mortar strength and Organic Impurities. If the DME determines it is necessary, because of unknown characteristics of new sources or changes in existing sources, provide fine aggregates that comply with the following:

Mortar Strength (KTMR-26). Compressive strength when combined with Type III (high early strength) cement:

- At age 24 hours, minimum 100%*
- At age 72 hours, minimum 100%*

*Compared to strengths of specimens of the same proportions, consistency, cement and standard 20-30 Ottawa sand.

- Organic Impurities (AASHTO T 21). The color of the supernatant liquid is equal to or lighter than the reference standard solution.

(b) Provide FA-C for Multi/Single-Layer and Slurry Polymer Concrete Overlay complying with **TABLE 1102-5**.

TABLE 1102-5: QUALITY REQUIREMENTS FOR MULTI/SINGLE-LAYER POLYMER CONCRETE OVERLAY		
Property	Requirement	Test Method
Soundness, minimum	0.92	KTMR-21
Wear, maximum	30%	AASHTO T 96
Acid Insoluble Residue, minimum	55%	KTMR-28
Uncompacted Voids Fine Aggregate, minimum	45	KT-50
Moisture Content, maximum	0.2%	KT-11

(3) Product Control.

(a) Size Requirements. Provide FA-C for Multi/Single-Layer and Slurry Polymer Concrete Overlay complying with **TABLE 1102-6**. Provide FA-A that comply with **TABLE 1102-6** or some other gradation approved by the engineer that will provide a combined aggregate gradation meeting **subsection 1102.2.b**.

TABLE 1102-6: GRADING REQUIREMENTS FOR FINE AGGREGATES FOR CONCRETE								
Type	Percent Retained-Square Mesh Sieves							
	3/8"	No. 4	No. 8	No. 16	No. 30	No. 50	No. 100	No. 200
FA-A	0	0-10	0-27	15-55	40-77	70-93	90-100	98-100
FA-C	0	0	25-70	95-100	98-100	98-100	98-100	98-100

(b) Deleterious Substances.

Type FA-A: Maximum allowed deleterious substances by weight are:

- Coal (AASHTO T 113) 0.5%
- Sticks (wet) (KT-35) 0.1%
- Sum of all deleterious 0.5%

f. Miscellaneous Aggregates for Concrete.

(1) Aggregates for Mortar Sand, Type FA-M.

(a) Composition. Provide aggregates for mortar sand, Type FA-M that is natural occurring sand.

(b) Quality. Mortar strength and Organic Impurities. If the DME determines it is necessary, because of unknown characteristics of new sources or changes in existing sources, provide aggregates for mortar sand, Type FA-M that comply with the following:

Mortar Strength (KTMR-26). Compressive strength when combined with Type III (high early strength) cement:

- At age 24 hours, minimum 100%*
- At age 72 hours, minimum 100%*

*Compared to strengths of specimens of the same proportions, consistency, cement and standard 20-30 Ottawa sand.

Organic Impurities (AASHTO T 21). The color of the supernatant liquid is equal to or lighter than the reference standard solution.

(c) Product Control. Size Requirements. Provide aggregates for mortar sand, Type FA-M that comply with **TABLE 1102-7**.

TABLE 1102-7: GRADING REQUIREMENTS FOR MORTAR SAND								
Type	Percent Retained - Square Mesh Sieves							Gradation Factor
	No. 4	No. 8	No. 16	No. 30	No. 50	No. 100	No. 200	
FA-M	0	0-2	0-30	20-50	50-75	90-100	98-100	1.70-2.50

Deleterious Substances. **Subsection 1102.2a.(4)**, as applicable.

(2) Lightweight Aggregate.

(a) Composition. Provide a lightweight aggregate consisting of expanded shale, clay or slate produced from a uniform deposit of raw material.

(b) Quality.

- Soundness, minimum (KTMR-21) 0.90
- Loss on Ignition 5%

(c) Product Control.

- Size Requirements. Provide lightweight aggregate that complies with **TABLE 1102-8**.

TABLE 1102-8: GRADING REQUIREMENTS FOR LIGHTWEIGHT AGGREGATES								
Type	Percent Retained - Square Mesh Sieves							
	¾"	½"	⅜"	No. 4	No. 8	No. 16	No. 50	No. 100
Grade 1	0	0-10	30-60	85-100	95-100			
Grade 2		0-2	0-30	20-50	50-75	90-100		
Grade 3			0	0-15		20-60	65-90	75-100

- Deleterious Substances. **Section 1102.2a.(4)** as applicable.
- Organic Impurities (AASHTO T 21). The color of the supernatant liquid is equal to or lighter than the reference standard solution.
- Unit Weight (dry, loose weight) (max.) 1890 lbs/cu yd.

(d) Modified Lightweight Aggregate. Lightweight aggregate produced from a uniform deposit of raw material combined with FA-A **subsection 1102.2c**. Provide lightweight aggregate that meets the Grade 1 or Grade 2 requirements in **TABLE 1102-8**.

(e) Lightweight Fine Aggregate for Internally Cured Concrete. Provide lightweight aggregate that meets the Grade 3 requirements in **TABLE 1102-8**. Internally cured concrete shall have lightweight fine aggregate proportions calculated per **15-PS0166 subsection 401.3g**. Submit lightweight fine aggregate properties for absorption,

desorption, and specific gravity along with the concrete mix design to Construction and Materials for approval prior to use.

(f) Concrete Making Properties. Drying shrinkage of concrete specimens prepared with lightweight aggregate proportioned as shown in the Contract Documents cannot exceed 0.07%.

(g) Uniformity of Supply. Designate or determine the fineness modulus (grading factor) according to procedure listed in Part V, Section 5.10.5 Fineness Modulus of Aggregates (Gradation Factor) before delivery, or from the first 10 samples tested and accepted. Provide aggregate that is within ± 0.20 of the average fineness modulus.

(h) Proportioning Materials. Submit mix designs for concrete using lightweight aggregate to Construction and Materials for approval prior to use.

(i) Lightweight Stockpile Management. Lightweight aggregate stockpiles shall be limited to 5 ft in height to promote even distribution of moisture and particle size. Use sprinklers to uniformly apply water to soak the stockpile(s) for a minimum of 72 hours or until a constant absorption is achieved. If steady rain of comparable intensity occurs, the sprinkler system may be turned off, if approved by the engineer. Turning the stockpiles daily and immediately prior to sampling and batching concrete will be necessary to assure uniform prewetting and drainage and care should be taken to prevent segregation. Prewetting of lightweight aggregate shall stop 24 hours prior to batching to allow the stockpile to drain. As placement proceeds turn the pile as necessary to equalize the moisture content of the aggregate.

(j) Determining moisture contents for proportioning and batching. Turn the stockpile to equalize the moisture content and measure the absorption of the lightweight aggregate (to establish the amount of internal curing water) 24 hours prior to batching. Turn the stockpile to equalize the moisture content and determine the aggregate surface moisture not more than one hour before batching concrete. In both cases, samples shall be obtained in accordance with KT-01.

1102.3 TEST METHODS

Test aggregates according to the applicable provisions of **SECTION 1115**.

1102.4 PREQUALIFICATION

Aggregates for concrete must be prequalified according to **subsection 1101.4**.

1102.5 BASIS OF ACCEPTANCE

The engineer will accept aggregates for concrete based on the prequalification required by this specification and **subsection 1101.5**.

09-05-19 R (DAM)

**KANSAS DEPARTMENT OF TRANSPORTATION
SPECIAL PROVISION TO THE
STANDARD SPECIFICATIONS, EDITION 2015**

For Low-Cracking High-Performance Concrete, delete SECTION 402 and replace with the following:

SECTION 402

STRUCTURAL LOW-CRACKING HIGH-PERFORMANCE CONCRETE

402.1 DESCRIPTION

Provide the grades of concrete specified in the contract documents.

This specification is specific to structural concrete. See **SECTION 401** for general concrete requirements.

402.2 MATERIALS

Provide materials that comply with the applicable requirements.

General Concrete **15-PS0166**

Aggregate **15-PS0168**

Admixtures, and Plasticizers **DIVISION 1400**

Cement, Fly Ash, Silica Fume, Slag Cement, and Blended Supplemental

Cementitious **DIVISION 2000**

Water **DIVISION 2400**

402.3 CONCRETE MIX DESIGN

a. General. Structural LC-HPC mix designs shall include internal curing. Design structural concrete mixes as specified in the contract documents.

b. **Concrete Mix Design.** Two options are available for mix design procedures. Use the procedures outlined in **15-PS0166** to design structural concrete mixes.

c. **Concrete Strength Requirements.** Design concrete to meet the strength requirements of **15-PS0166**.

d. **Portland Cement, Blended Hydraulic Cement, and Individual and Blended Supplemental Cementitious Materials.** Unless specified otherwise in the contract documents, select the type of portland cement, blended hydraulic cement, and individual and blended supplemental cementitious materials according to **15-PS0166**.

e. **Structural Concrete Specific Requirements.** Design air-entrained concrete to meet the requirements shown in **TABLE 402-1** for the type of concrete specified in the contract documents.

TABLE 402-1: AIR ENTRAINED CONCRETE FOR BRIDGE DECKS				
Grade of Concrete	lb of Cementitious per cu yd of Concrete	lb of Water per lb of Cementitious¹	Designated Air Content Percent by Volume	Supplementary Cementitious Material (by weight of cementitious materials)
LC-HPC	500 min. / 560 max	0.43 – 0.45	8.0 ± 1.5 ²	Max 30% Slag Cement and Max 2% Silica Fume
All other concrete	480 min.	0.45 max	15-PS0166 subsection 401.3j	See 15-PS0166 subsection 401.3c or 401.3d

¹Limits of lb. of water per lb. of cementitious material as designed. Includes free water in aggregates but excludes water of absorption of the aggregates.

²Use the middle of the specified range of 8.0 ± 1.5% for the design of the LC-HPC concrete. Maximum air content is 10%. Concrete with an air content less than 6.5% or greater than 10 % shall be rejected. Take immediate steps to reduce the air content whenever the air content exceeds 9.5%. The engineer will sample concrete for tests at the discharge end of the conveyor, bucket, or end of the placement hose.

- (1) Determine the air loss due to pumping operations once in the AM and once in the PM. Determine the difference between the air content from concrete sampled before the pump, and concrete sampled after

pumping. Make adjustment to the mix to compensate for the pumping of the concrete.

- (2) Concrete permeability requirements according to **TABLE 402-2**.
- (3) For non-LC-HPC Concrete, test data from KT-73 tested at 28 days, KT-79 tested at 28 days, or AASHTO T-277 tested at 56 days. For LC-HPC Concrete, submit results from KT-79 tested at 28 days or AASHTO T-277 at 56 days. Provide test results on a minimum of one set of three cylinders for each mix, tested at the highest water to cementitious ratio that meets **15-PS0166 subsections 401.3e.** and **401.3j**. Submit accelerated cure procedures for the engineer’s approval. The use of supplemental cementitious materials may be necessary to meet permeability requirements. See **15-PS0166**.
- (4) Use quality and gradation requirements for structural aggregates as listed in **15-PS0168**, aggregates for concrete not placed on grade.
- (5) Use MA-6 optimized gradation for low permeability concrete for bridge overlays.
- (6) ASTM C-1567 is required for some combinations of aggregate and supplementary cementitious materials (SCMs). See **15-PS0166 subsection 401.3k.** for requirements.

TABLE 402-2: PERMEABILITY REQUIREMENTS FOR STRUCTURAL CONCRETE			
	Volume of Permeable Voids, maximum	Surface Resistivity, minimum	Rapid Chloride Permeability, maximum
Use Low Permeability Concrete (LPC) for Bridge Overlays	9.5%	27.0 kΩ-cm	1000 Coulombs
Use Low-Cracking High-Performance Concrete (LC-HPC) if specified in the Contract Documents	Not Permitted	19.0 kΩ-cm	1500 Coulombs
Use Moderate Permeability Concrete (MPC) for specified Full Depth Bridge Decks	11.0%	13.0 kΩ-cm	2000 Coulombs
Use Standard Permeability Concrete (SPC) for all other structural concrete not specified as LC-HPC, Low or Moderate Permeability	12.5%	9.0 kΩ-cm	3000 Coulombs

f. Slump.

- (1) Designate a slump for each concrete mix design that is required for satisfactory placement of the concrete application. Reject concrete with a slump that limits the workability or placement of the concrete.
- (2) If the designated slump is 3 inches or less, the tolerance is $\pm 3/4$ in., or limited by the maximum allowable slump for the individual type of construction.
- (3) If the designated slump is greater than 3 in. the tolerance is $\pm 25\%$ of the designated slump.
- (4) For drilled shafts the target slump just prior to being pumped into the drilled shaft is 9 inches. If the slump is less than 8 in., redose the concrete with admixtures as permitted in **15-PS0166 subsection 401.3l**.
- (5) Do not designate a slump in excess of 4 in. for LC-HPC and 5 in. for all other structural concrete.

09-05-19 R (DAM)

**KANSAS DEPARTMENT OF TRANSPORTATION
SPECIAL PROVISION TO THE
STANDARD SPECIFICATIONS, EDITION 2015**

For Low-Cracking High-Performance Concrete, delete SECTION 710 and replace with the following:

SECTION 710

LOW-CRACKING HIGH-PERFORMANCE CONCRETE-CONSTRUCTION

710.1 DESCRIPTION

Construct concrete structures according to the contract documents. When Bridge Deck Grooving is a bid item in the contract, perform the grooving as shown in the contract documents.

BID ITEMS	UNITS
Concrete (*) (**) (***) (****)	Cubic Yard
Bridge Deck Grooving	Square Yard
<small>*Grade of Concrete **AE (air-entrained), if specified ***Aggregate, if specified ****MPC (Moderate Permeability Concrete), if specified</small>	

710.2 MATERIALS

Provide materials that comply with the applicable requirements.

- Concrete⁺ 15-PS0166 and 15-PS0167
- Aggregates for Concrete Not On Grade 15-PS0168
- Concrete Curing Materials DIVISION 1400
- Joint Sealing Compounds DIVISION 1500
- Type B Preformed Expansion Joint Filler DIVISION 1500
- Preformed Elastomeric Compression Joint Seals DIVISION 1500
- Bridge Number Plates DIVISION 1600

⁺ If Moderate Permeability Concrete (MPC) is not specified, the concrete shall meet the requirements for Standard Permeability Concrete.

710.3 CONSTRUCTION REQUIREMENTS

a. Qualification Batch for LC-HPC. For each bridge deck containing LC-HPC, produce a qualification batch of at least six cubic yards using concrete that is to be placed in the deck and complies with **15-PS0166 subsection 401.8b(2)**. A representative from the lightweight aggregate supplier must be present for the qualification batch. This representative shall have the necessary technical expertise to understand the properties of lightweight fine aggregate for internal curing in structural concrete.

The engineer will be in attendance. Do not commence placement of concrete in the deck until approval is given by the engineer. Approval to place concrete on the deck will be based on satisfactory compliance with the specification and will be given or denied within 24 hours of the qualification batch.

a. Falsework and Forms. Construct falsework and forms according to **SECTION 708**.

b. Handling and Placing Concrete. At a progress project meeting prior to placing concrete, discuss with the engineer the method and equipment used for deck placement; include the equipment for controlling the evaporation rate and concrete temperature, procedures used to minimize the evaporation rate, method to place saturated burlap within the specified 15 minute limit, and plans to maintain a continuous supply of concrete throughout placement with an adequate quantity of concrete to complete the deck and filling diaphragms and end walls in advance of deck placement.

Fogging using hand-held equipment may be required by the engineer during unanticipated delays in the placing, finishing or curing operations. If fogging is required by the engineer, do not allow water to drip, flow or puddle on the concrete surface during fogging, placement of absorptive material, or at any time before the concrete has achieved final set.

When needed, produce a fog spray from nozzles that atomize the droplets and a system capable of keeping a large surface area damp without depositing excess water. Use high pressure equipment that generates a minimum of 1200 psi at 2.2 gpm, or low-pressure equipment having nozzles capable of supplying a maximum flow rate of 1.6 gpm.

Use a method and sequence of placing concrete approved by the engineer. Do not place concrete until the forms and reinforcing steel have been checked and approved. Before placing

concrete, clean all forms of debris. Drive all foundation piling in any one pier or abutment before concrete is poured in any footing or column of that pier or abutment.

On bridges skewed greater than 10°, place concrete on the deck forms across the deck on the same skew as the bridge, unless approved otherwise by State Bridge Office (SBO). Operate the bridge deck finishing machine on the same skew as the bridge, unless approved otherwise by the SBO.

Maintain environmental conditions on the entire bridge deck such that the evaporation rate is less than 0.2 lb/sq ft/hr. This may require placing the deck at night, in the early morning or on another day. The evaporation rate (as determined in the American Concrete Institute Manual of Concrete Practice 305R, Chapter 2) is a function of air temperature, concrete temperature, wind speed, and humidity.

Just prior to and at least once per hour during placement of the concrete, the engineer will measure and record the air temperature, concrete temperature, wind speed, and humidity on the bridge deck. The Engineer will take the air temperature, wind, and humidity measurements approximately 12 in. above the surface of the deck. With this information, the engineer will determine the evaporation rate by using KDOT software or by using **FIGURE 710-1** (Figure 2.1.5 from the American Concrete Institute Manual of Concrete Practice 305R, Chapter 2).

When the evaporation rate is equal to or above 0.2 lb/ft²/hr, take actions (such as cooling the concrete, installing wind breaks, sun-screens, etc.) to create and maintain an evaporation rate less than 0.2 lb/ft²/hr on the entire bridge deck.

Place concrete to avoid segregation of the materials and displacement of the reinforcement. Do not deposit concrete in large quantities at any point in the forms, and then run or work the concrete along the forms.

Deposit the concrete in the forms in horizontal layers. Perform the work rapidly and continuously between predetermined planes. Vibrate through each plane.

Fill each part of the form by depositing the concrete as near to the final position as possible. If the chutes for placement of concrete are on steep slopes, equip them with baffle boards or assemble in short lengths that reverse the direction of movement. Do not drop concrete in the forms a distance of more than 5 feet, unless confined by clean, smooth, closed chutes or pipes.

Work the coarse aggregate back from the forms and around the reinforcement without displacing the bars. After initial set of the concrete, do not disturb the forms, or place any strain on the ends of projecting reinforcement.

If placing concrete by pumping, place the concrete in the pipeline to avoid contamination or separation of the concrete, or loss of air by fitting the pump with a concrete brake (e.g., french horn or bladder valve) at the end of the pump boom. Obtain sample concrete for slump and air test requirements at the discharge end of the piping.

Do not use chutes, troughs, or pipes made of aluminum.

Uniformly consolidate the concrete without voids. In case voids are present after consolidation, the vibrator shall be reinserted near within one-half of the radius of action to remove the hole and fully reconsolidate the concrete.

Accomplish consolidation of the concrete on all span bridges that require finishing machines by means of a mechanical device on which internal (spud or tube type) concrete vibrators of the same type and size are mounted (**subsection 154.2**). Workers shall not walk in concrete that has been consolidated by this method. Vibrators and finishing equipment shall be as close to each other as possible to prevent workers from walking in the concrete after consolidation. Observe special requirements for vibrators in contact with epoxy coated reinforcing steel as specified in **subsection 154.2**. Provide stand-by vibrators for emergency use to avoid delays in case of failure.

Operate the mechanical device so vibrator insertions are made on a maximum spacing of 12-in. centers over the entire deck surface. Provide a uniform time per insertion of all vibrators of 3 to 15 seconds, or until the coarse aggregate settles below the surface of the concrete, unless otherwise designated by the engineer. Provide positive control of vibrators using a timed light, buzzer, and automatic control. The vibrators shall be removed slowly enough to allow the concrete to close in around the vibrator heads as they are removed so that no voids are left at the concrete surface. Do not drag the vibrators horizontally through the concrete.

Use handheld vibrators (**subsection 154.2**) in inaccessible and confined areas such as along hubguards. When required, supplement vibrating by hand spading with suitable tools to provide required consolidation.

Reconsolidate any voids left by workers by reinserting the vibrator within one-half of the radius of action.

Deposit concrete in water, only with approval from the engineer. Do not place concrete in running water.

Use forms that are reasonably watertight to hold concrete deposited under water. Increase the minimum cement factor of the grade of concrete being deposited in water by 10%, obtaining approximately a 6-in. slump. Carefully deposit the concrete in place, in a compact mass, using a tremie pumped through piping, bottom-dumping bucket, or other approved method that does not permit the concrete to fall through the water. Do not pump water from the inside of the foundation forms while concrete is being placed. Do not disturb the concrete after being deposited. If necessary to prevent flooding, place a seal of concrete through a closed chute or tremie, and allow it to set.

Continuously place concrete in any floor slab until complete, unless shown otherwise in the contract documents.

The method used for transporting concrete batches, materials, or equipment over previously placed single pour (non-overlaid) floor slabs or floor units, or over units of structures of continuous design types is subject to approval by the Engineer.

Do not operate bridge deck finishing equipment on previously placed concrete spans until:

- A minimum of 72 hours on structures that are fully supported with falsework;
- A minimum of 72 hours on structures with concrete girder spans with concrete decks; and
- A minimum of 96 hours on structures with steel girder spans with concrete decks.

The time delays begin after the day's pour has been completed.

Follow **TABLE 710-2** for load limitations after concrete placement. Prior to permitting approved traffic on the bridge deck, construct temporary bridge approaches and maintain them in a condition to prevent damage to the bridge ends.

FIGURE 710-1: STANDARD PRACTICE FOR CURING CONCRETE

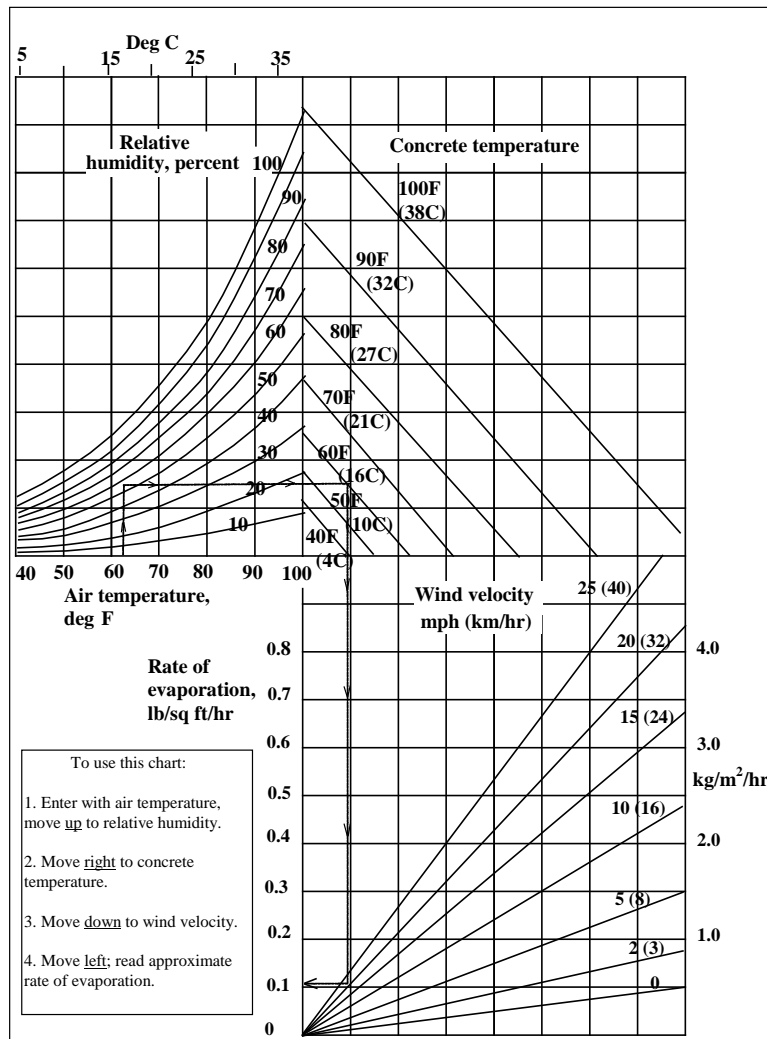

Effect of concrete and air temperatures, relative humidity, and wind velocity on the rate of evaporation of surface moisture from concrete. This chart provides a graphic method of estimating the loss of surface moisture for various weather conditions. To use the chart, follow the four steps outlined above. When the evaporation rate exceeds 0.2 lb/ft²/hr (1.0 kg/m²/hr), measures shall be taken to prevent excessive moisture loss from the surface of unhardened concrete; when the rate is less than 0.2 lb/ft²/hr (1.0 kg/m²/hr) such measures may be needed. When excessive moisture loss is not prevented, plastic cracking is likely to occur.

c. Construction Joints, Expansion Joints and End of Wearing Surface (EWS)

Treatment. Locate the construction joints as shown in the contract documents. If construction joints are not shown in the contract documents, submit proposed locations for approval by the engineer.

If the work of placing concrete is delayed and the concrete has taken its initial set, stop the placement, saw the nearest construction joint approved by the engineer and remove all concrete beyond the construction joint. On post-tensioned structures construct a stepped joint as shown in the contract documents.

When the contract documents show a construction joint in the wall of the RCB 3 in. above the floor, the contractor has the option of constructing the joint as shown on the contract documents or constructing the joint level with the floor of the RCB. When the contract documents show a construction joint in the wall of the RFB 2 in. above the floor haunch, the contractor has the option of constructing the joint as shown on the contract documents, or even with the top of the floor haunch of the RFB.

If dowels, reinforcing bars or other tie devices are not required by the contract documents, make a key in the construction joint. Construct keyed joints by embedding water-soaked, beveled timbers of a size shown on the contract documents, into the soft concrete. Remove the timber when the concrete has set. When resuming work, thoroughly clean the surface of the concrete previously placed, and when required by the engineer roughen the key with a steel tool. Before placing concrete against the keyed construction joint, the joint shall be cleaned of surface laitance, curing compound, and all other foreign material, use of abrasive blasting may be required to achieve the level of cleanliness required. Thoroughly wash the surface of the keyed joint with clean water and allow the joint to dry to a saturated surface dry condition immediately prior to placing fresh concrete against the joint key.

- (1) Bridges With Tied Approaches. When concrete is placed at the bridge EWS, embed 3 (½-in. by 8-in.) bolts to hold a header board for each traffic lane into the vertical surface of the EWS. Finish the surface of the EWS using an edging tool with a ¼ in. radius. Immediately after the vertical forms on the EWS are removed, protect the exposed EWS by bolting a wooden header (minimum dimension of 2 ⅝ in. by 7 ½ in.) to the exposed vertical surface of the EWS. Extend the header board the full width of the EWS, or use 1 section of header board for each lane of traffic. Shape the header board to comply with the crown of the bridge surface and install it flush with the concrete wearing surface. Do not bend the reinforcing steel which will tie the approach slab to the EWS or damage the concrete at the EWS.

(2) Bridges Without Tied Approaches. Place the concrete for the approach slab, and at the end of the approach slab away from the EWS place bolts and attach a header board in the same manner required for bridges with tied approaches. If the contractor needs to drive on the bridge before the approach slabs can be placed and cured construct a temporary bridge from the approach over the EWS capable of supporting the anticipated loads. The method of bridging must be approved by the engineer.

d. Finishing. Finish all top surfaces, such as the top of retaining walls, curbs, abutments, and rails with a wooden float by tamping, floating, flushing the mortar to the surface, and provide a uniform surface, free from pits or porous places. Trowel the surface producing a smooth surface, and brush lightly with a damp brush to remove the glazed surface.

Strike-off bridge decks with a self-propelled finishing machine, which may be manually operated by winches to reach a temporary bulkhead when approved by the engineer. The screed on the finish machine must be self-oscillating and operate or finish from a position either on the skew or transverse to the bridge roadway centerline.

On decks skewed greater than 10°, operate the finishing machine on the same skew as the bridge, unless approved otherwise by the SBO. Before placing concrete, position the finisher throughout the proposed placement area allowing the engineer to verify the reinforcing steel positioning.

Irregular sections may be finished by other methods approved by the engineer. Reinforced concrete box bridges that will be under fill may be struck off by other approved methods.

Finish the surface using one or more metal pans or burlap drag or a combination mounted to the finishing equipment. Do not add water or other finishing aids to the surface of concrete.

Secure a smooth riding bridge deck, correcting surface variations exceeding 1/8 in. in 10 feet by use of an approved profiling device, or other method approved by the engineer.

Straightedge decks that are to receive an overlay, leaving them with an acceptable float or machine pan finish.

For decks not receiving an overlay, and without the bid item Bridge Deck Grooving, finish the deck with the rough burlap drag.

For decks not receiving an overlay, and with the bid item Bridge Deck Grooving, see **subsection 710.3f.** for grooving requirements.

After finishing operations are complete on a section, workers shall not disturb that section of concrete.

Obtain reasonably true and even concrete surfaces, free from stone pockets, excessive depressions, or projections on the surface. Strike-off with a straightedge and float the concrete in bridge seats and walls flush with the finished top surface.

As soon as the forms are removed and the concrete is ready to hone, rub the concrete surfaces that are not in an acceptable condition, or are designated in the contract documents to be surface finished to a smooth and uniform texture with a carborundum brick and clean water. Remove the loose material formed on the surface, due to the rubbing with a carborundum brick as soon as it dries. The finished surface shall be free from all loose material. Do not use a neat cement wash.

Give handrails, handrail posts, the deck side, and the top and end of all curbs, except curbs of structures having the top of curb below the final shoulder elevation of the road, an acceptable troweled or floated finish. This includes the back of the inside rails of side-by-side structures, or any rails easily viewed by the traveling public.

Remove the forms as early as possible and perform the float finish while the concrete is still green. Use mortar during the float finish operation to fill in air and water voids and supplement the float finish. Keep surfaces requiring a rubbed finish moist before and during the rubbing. Do not use a mortar coating after the concrete has cured.

Unless otherwise provided in the contract documents, all reasonably true and even surfaces, obtained by use of a form lining, which are of a uniform color, free from stone pockets, honeycomb, excessive depressions, or projections beyond the surface, are considered as acceptable surfaces, and a rubbed surface finish is not required.

The engineer may require the use of a dry carborundum brick for straightening molding lines, removing fins or requiring a rubbed surface finish on all portions of the structure that do not present an acceptable surface even though a form lining is used.

e. Curing and Protection.

(1) General. Cover concrete surfaces according to **TABLE 710-1**. Cure all pedestrian walkway surfaces in the same manner as the bridge deck. The determination of the time requirement for curing commences after all the concrete for the placement is in place and finished. During cold weather, the specified time limits may be increased at the discretion of the engineer, based upon the amount of protection and curing afforded the concrete.

Maintain a damp surface until the wet burlap is placed. Fully saturate burlap before placing on concrete surface. Soak the burlap for a minimum of 12 hours prior to placement on the deck. Re-wet the burlap if it has dried for more than one hour before it is applied to the surface of bridge deck. Apply one layer of wet burlap within 15 minutes of strike-off from the screed, followed by a second layer of wet burlap within 10 minutes. Do not allow the surface to dry after the strike-off, or at any time during the cure period. Do not mar concrete during placement of the wet burlap. Maintain the curing so that moisture is always present at the concrete surface.

Place and weight down the burlap so it will remain in intimate contact with the surface covered.

When an impermeable sheeting material is used, lap each unit 18 in. with the adjacent unit. Place and weight down the impermeable sheeting material so it will remain in intimate contact with the surface covered. When any burlap or impermeable sheeting material becomes perforated or torn, immediately repair it, or discard and replace it with acceptable material.

TABLE 710-1: MINIMUM CURE TIMES AND CURING MEDIUMS		
Type of Work	Minimum Cure Time (days)	Curing Medium and Use
Bridge decks (full-depth decks with multi-layer polymer overlays) Bridge subdecks (decks with overlays)	14 Wet	Wet burlap covered with white polyethylene sheeting during the 14-day period.
Bridge decks (full-depth decks with no overlay) Bridge Overlays	14 Wet Plus 7 Curing Membrane	Wet burlap covered with white polyethylene sheeting during the 14-day period. After the wet cure period, apply 2 coats of Type 2 white liquid membrane forming compound. Place the first coat within 30 minutes of removing the sheeting and burlap. Spray the second coat immediately after and at right angles to the first application. Protect the curing membrane against marring for a minimum of 7 days. The Engineer may limit work during this 7-day period.
Other unformed or exposed surfaces	7 Curing Membrane	Apply two coats of Type 2 white liquid membrane forming compound. Place the first coat immediately after completion of the concrete finish just as the surface water disappears. Spray the second coat immediately after and at right angles to the first application. Protect the curing membrane against marring for a minimum of 7 days. The Engineer may limit work during this 7-day period. Should the compound be subjected to continuous damage, the Engineer will require wet burlap, white polyethylene sheeting or other approved impermeable material to be applied at once for the remainder of the cure time.
Formed sides and ends of bridge wearing surfaces and bridge curbs Other formed surfaces	4 Formed	Formed surfaces will be considered completely cured upon the Engineer's permission to remove the forms, providing the forms have been in place for a minimum of 4 days. If forms are removed before the end of the 4-day cure period, cure the surface with an application of Type 1-D liquid membrane forming compound.

(2) Liquid Membrane Forming Compounds. Use spraying equipment capable of supplying a constant and uniform pressure to provide uniform distribution at the rates required. Agitate the liquid membrane forming compound continuously during application. The surface must be kept wet from the time it is finished until the liquid membrane forming compound is applied. Apply liquid membrane forming compound at a minimum rate per coat of one gallon per 200 square feet of concrete surface.

Give marred or otherwise damaged applications an additional coating.

If rain falls on the newly coated concrete before the film has dried sufficiently to resist damage from the rain, or if the film is damaged by any other means, apply a new coat of the membrane to the affected portion equal in curing value to the original application.

(3) Bridge Subdecks and Decks. Provide a work bridge to facilitate application of all curing materials. Maintain the curing so that moisture is always present at the concrete surface.

Maintain the wet burlap in a fully wet condition using misting hoses, self-propelled, machine-mounted fogging equipment with effective fogging area spanning the deck width, moving continuously across the entire burlap-covered surface, or other approved devices until the concrete has set sufficiently to allow foot traffic. At that time, place soaker hoses on the burlap, and supply running water continuously to maintain continuous saturation of all burlap material to the entire concrete surface. For bridge decks with superelevation, place a minimum of one soaker hose along the high edge of the deck to keep the entire deck wet during the curing period.

If the concrete surface temperature is above 90°F, do not use polyethylene sheeting in direct sunshine during the day for the first 24 hours of the specified curing period (**TABLE 710-1**). White polyethylene sheeting may be used at night to maintain the required damp condition of the burlap. When polyethylene sheeting is used over the burlap at night during the first 24 hours and the concrete surface temperature is above 90 °F, place the polyethylene sheeting a maximum of 1 hour before sunset, and remove the polyethylene sheeting within 1 hour after sunrise. After the first 24 hours, the polyethylene sheeting may be left in place continuously for the remainder of the curing period provided the burlap is kept damp.

Construction loads on the new bridge subdeck, new one-course deck or any concrete overlay are subject to the limitations in **TABLE 710-2**. The use of supplemental cementitious materials will require additional time before specified loading is allowed.

TABLE 710-2: CONCRETE LOAD LIMITATIONS ON BRIDGE DECKS		
Days after concrete is placed	Element	Allowable Loads
1*	Subdeck, one-course deck or concrete overlay	Foot traffic only.
3*	One-course deck or concrete overlay	Work to place reinforcing steel or forms for the bridge rail or barrier.
7*, Δ	Concrete overlays	Legal Loads; Heavy stationary loads with the Engineer's approval.***
10 *, Δ (15)**, Δ	Subdeck, one-course deck or post-tensioned haunched slab bridges	Light truck traffic (gross vehicle weight less than 5 tons).****
14 *, Δ (21)**, Δ	Subdeck, one-course deck or post-tensioned haunched slab bridges	Legal Loads; Heavy stationary loads with the Engineer's approval.***Overlays on new decks.
28	Bridge decks	Overloads, only with the State Bridge Engineer's approval.***

*Maintain the specified wet cure at all times (TABLE 710-1).

** All haunched slab structures.

*** Submit the load information to the appropriate Engineer. Information that will be required is the weight of the material and the footprint of the load, or the axle (or truck) spacing and the width, the size of each tire (or track length and width) and their weight.

****An overlay may be placed using pumps or conveyors until legal loads are allowed on the bridge.

ΔIncrease time period by 3 days when supplemental cementitious materials are used October 1 thru April 30.

(4) Surfaces Requiring Rubbed Finish. Apply Type 1-D liquid membrane-forming compound immediately after the surface is completed, and while the concrete is still damp.

(5) Cold Weather Curing. If concrete is placed in cold weather, comply with **15-PS0166**.

If concrete is placed and the ambient air temperature is expected to drop below 40 °F during the entire specified curing period or when the ambient air temperature is expected to drop more than 25 °F below the temperature of the concrete during the first 24 hours after placement, provide suitable measures such as straw, additional burlap or other suitable blanketing materials or housing and artificial heat to maintain the concrete temperature between 40 and 90 °F as measured on the surface of the concrete. Keep the surface of the concrete moist by the use of an approved moisture barrier such as wet burlap or polyethylene sheeting or both as defined in **TABLE 710-1**. Maintain the moisture barrier in intimate contact with the concrete during the entire specified curing period. For every day the ambient air temperature is below 40 °F, an additional day of curing with a minimum ambient air temperature of 50 °F will be required. After completion of the required

curing period, remove the curing and protection so that the temperature of the LC-HPC during the first 24 hours does not fall more than 25 °F.

(6) If concrete is placed in cofferdams and subsequently flooded with ground water, the specified curing conditions are waived providing the surface of the water does not freeze.

f. Grinding and Grooving. Correct surface variations exceeding $\frac{1}{8}$ in. in 10 feet by use of an approved profiling device, or other methods approved by the Engineer after the curing period. Perform grinding on hardened concrete after the specified curing membrane period (**TABLE 710-1**) to achieve a plane surface and grooving of the final wearing surface as shown in the Contract Documents. Apply the corrective measure to the full width of the lane. The corrected areas shall have uniform texture and appearance. The beginning and ending of the corrected areas shall be squared normal to centerline of the paved surface.

If at least 25% of the traveled way of the deck needs ground to correct surface variations, grind the entire deck.

Use a self-propelled grinding machine with diamond blades mounted on a multi-blade arbor. Avoid using equipment that causes excessive ravels, aggregate fractures, or spalls. Remove from the project and properly dispose of the material. Do not allow the grinding slurry to flow across lanes being used by traffic, onto shoulder slopes, into streams, lakes, ponds or other bodies of water, or gutters or other drainage facilities. Do not place grinding slurry on foreslopes.

After any required grinding is complete and after the specified curing membrane period (**TABLE 710-1**), give the surface a suitable texture by transverse grooving. Use diamond blades mounted on a self-propelled machine that is designed for texturing pavement. Transverse grooving of the finished surface may be done with equipment that is not self-propelled providing that the Contractor can show proficiency with the equipment. Use equipment that does not cause strain, excessive raveling, aggregate fracture, spalls, disturbance of the transverse or longitudinal joint, or damage to the existing concrete surface. Make the grooving approximately $\frac{3}{16}$ in. in width at $\frac{3}{4}$ in. centers and the groove depth approximately $\frac{1}{8}$ inch. Terminate the transverse bridge deck grooving approximately two feet in from the base of the rail, and one foot from any deck drains or other appurtenances.

If after corrective measures are made, more than ½ in. of the deck was ground at any location, the engineer may require a multi-layer polymer concrete overlay over the whole deck, according to **SECTION 729**, at no additional cost to KDOT.

g. Removal of Forms and Falsework. Do not remove forms and falsework without the engineer's approval. During cold weather, the specified time limits may be increased at the discretion of the engineer, based upon the amount of protection and curing afforded the concrete.

Do not remove forms and falsework until the minimum amount of time required for strength gain has elapsed, regardless of if the concrete is fully cured per **TABLE 710-1**.

If forms are removed before expiration of the cure period, maintain the cure as provided in **DIVISION 700**.

Remove forms on handrails, ornamental work and other vertical surfaces that require a rubbed finish as soon as the concrete has hardened sufficiently that it shall not be damaged.

Under normal conditions, the engineer will allow removal of forms and falsework according to **TABLE 710-3**. The determination of the time requirement for the removal of forms commences after all the concrete for the placement is in place and finished. If high early strength concrete is used, the specified time limits may be decreased as determined by the engineer and agreed upon before placing the concrete.

TABLE 710-3: MINIMUM STRENGTH GAIN TIME BEFORE REMOVAL OF FORMS & FALSEWORK (DAYS)							
Type of Work	Span Length (feet)						
	Less than 10	10 or less	Greater than 10	10 to 20	20 + to 30	Greater than 20	Greater than 30
Cantilevered Piers - Formwork (supporting the pier beam) supported on column		7 ^Δ [4]*	10 ^Δ [6]*				
Column Bent Piers - Falsework supporting pier beam**	4 ^Δ			7 ^Δ [4]*		10 ^Δ [6]*	
Forms and Falsework under slabs, beams, girders, arches and brackets***	4 ^Δ			7 ^Δ [4] ⁺	10 ^Δ [6] ⁺		15 ^Δ [10] ⁺
RCB and RFB top slabs not re-shored		7 ^Δ [4] ⁺		7 ^Δ [4] ⁺		10 ^Δ [6] ⁺	
Type of Work							Time (Days)
Walls, Wing Walls and vertical sides of RCB and RFB structures Do not backfill according to SECTION 204 , until 3 days after forms are removed.							4 ^Δ [3]*
Footing Supported on Piles - minimum cure before erecting forms and reinforcing steel for columns							4 ^Δ [2]*
Spread Footing founded in rock – minimum before erecting forms and reinforcing steel for columns							2 ^Δ
Footing supported on piles - minimum cure before erecting forms and reinforcing steel for columns							4 ^Δ [2]*
Columns for cantilevered piers - 1. minimum before supporting forms and reinforcing steel for the pier beam on the column. 2. minimum before placing concrete for the pier beam							4 ^Δ [2] ⁺ 7 ^Δ [4] ⁺
Columns for bent piers - 1. minimum before erecting formwork and reinforcing steel for the pier beam 2. minimum before placing concrete for the pier beam							2 ^Δ 4 ^Δ [2]*
Drilled shafts - minimum before erecting forms and reinforcing steel for the columns							2 ^Δ
Floors for RCB and RFB structures on rock or a seal course - minimum before erecting forms and reinforcing steel							2 ^Δ
Floors for RCB and RFB structures on soil or foundation stabilization - minimum before erecting forms and reinforcing steel							4 ^Δ [2]*
Do not remove forms or falsework from post tensioned elements until all applied post tensioning forces are transferred.							NA

*Contractors may reduce the time required before form removal to the number of days shown in brackets, provided the concrete is shown to have attained a minimum strength of 65% of the specified f'c. To accomplish this, prepare the necessary cylinders, obtain the services of an approved laboratory to break them at the appropriate time and provide a report to the Engineer. Field cure the cylinders alongside and under the same curing conditions, as the concrete they represent.

**Do not set girders or beams on the pier beams until the falsework under the pier beams is removed.

***Remove the formwork from subdecks or one-course decks within 6 weeks after the deck has been placed.

+ Contractors may reduce the time required before form removal to the number of days shown in brackets, provided the concrete is shown to have attained a minimum strength of 75% of the specified f'c. To accomplish this, prepare the necessary cylinders, obtain the services of an approved laboratory to break them at the appropriate time and provide a report to the Engineer. Field cure the cylinders alongside and under the same curing conditions, as the concrete they represent.

ΔIncrease the time period 3 days when supplemental cementitious materials are used October 1 thru April 30.

Reshoring of RCB and RFB (classified as culverts or bridges) top slab will be permitted if the contractor uses traveling forms or to reduce the minimum time shown in **TABLE 710-2**. At the preconstruction conference, submit calculations, sealed by a professional engineer, to the engineer that show that the concrete tensile stress is below $0.23 \sqrt{f'_c}$ (ksi) and the shoring has sufficient capacity.

In determining the time for the removal of forms, give consideration to the location and character of the structure, weather and other conditions influencing the setting of concrete. If forms are removed before expiration of the cure period, maintain the cure as provided in **DIVISION 700**.

For additional requirements regarding forms and falsework, see **SECTION 708**.

h. Bridge Number Marking. When designated in the contract documents, place bridge numbers on bridges by the use of plates recessed in the concrete during construction, using plates constructed as shown in the contract documents. The date placed on the plates is the year in which the structure is completed.

710.4 MEASUREMENT AND PAYMENT

The engineer will measure the various grades of concrete placed in the structure by the cubic yard. No deductions are made for reinforcing steel and pile heads extending into the concrete. When shown as a bid item in the contract, the engineer will measure for payment bridge deck grooving by the square yard.

Payment for the various grades of "Concrete" and "Bridge Deck Grooving" at the contract unit prices is full compensation for the specified work.

09-05-19 R (DAM)

Appendix D: Previous Data for Evaluation of Cracking Performance of Bridge Decks in Chapter 3

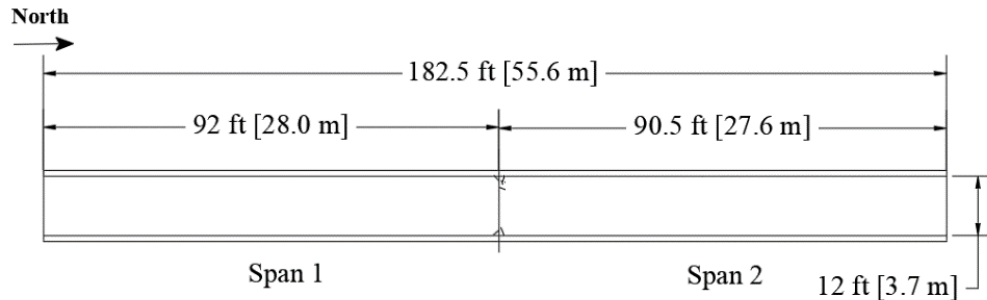

Bridge ID: MN-IC-LC-HPC-1	Bridge Length: 182.5 ft (55.6 m)	Bridge Age: 9.2 months
Bridge Number: 62892	Bridge Width: 12.0 ft (3.7 m)	Crack Density: 0.013 m/m ²
Bridge Location: Mackubin St. over I-94	Skew: 0°	Span 1: 0.010 m/m ²
Construction Date: 9/21/2016	Number of Spans: 2	Span 2: 0.016 m/m ²
Crack Survey Date: 6/27/2017	Span 1: 92.0 ft (28.0 m)	
	Span 2: 90.5 ft (27.6 m)	
	Number of Placements: 1	

Figure E.1: Crack Map for MN-IC-LC-HPC-1 (Survey 1)

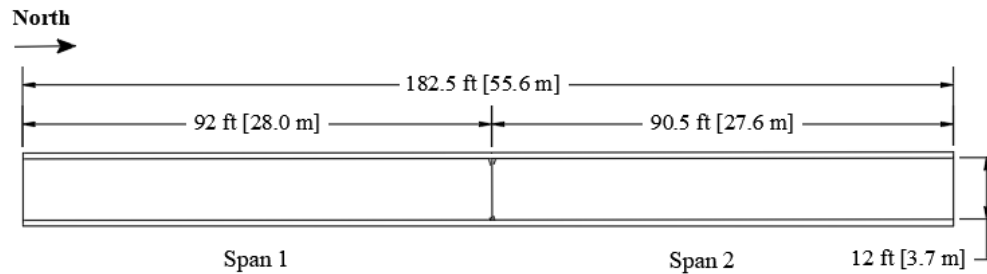

Bridge ID: MN-IC-LC-HPC-1	Bridge Length: 185.2 ft (56.4 m)	Bridge Age: 19.6 months
Bridge Number: 62892	Bridge Width: 12.0 ft (3.7 m)	Crack Density: 0.007 m/m ²
Bridge Location: Mackubin St. over I-94	Skew: 0°	Span 1: 0.006 m/m ²
Construction Date: 9/21/2016	Number of Spans: 2	Span 2: 0.009 m/m ²
Crack Survey Date: 5/8/2018	Span 1: 92.0 ft (28.0 m)	
	Span 2: 90.5 ft (27.6 m)	
	Number of Placements: 1	

Figure E.2: Crack Map for MN-IC-LC-HPC-1 (Survey 2)

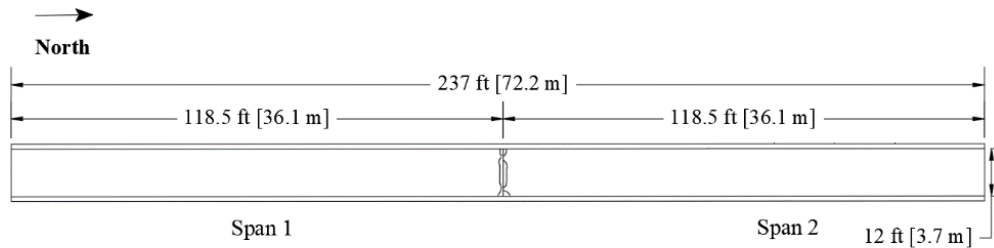

Bridge ID: MN-Control-1	Bridge Length: 237 ft (72.2 m)	Bridge Age: 32.2 months
Bridge Number: 62800	Bridge Width: 12.0 ft (3.7 m)	Crack Density: 0.029 m/m ²
Bridge Location: Grotto St. over I-94	Skew: 0°	Span 1: 0.029 m/m ²
Construction Date: 9/28/2016	Number of Spans: 2	Span 2: 0.028 m/m ²
Crack Survey Date: 6/3/2019	Span 1: 118.5 ft (36.1 m)	
	Span 2: 118.5 ft (36.1 m)	
	Number of Placements: 1	

Figure E.6: Crack Map for MN-Control-1 (Survey 3)

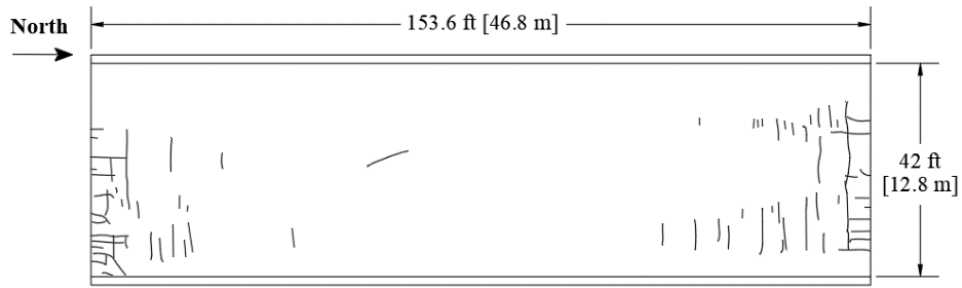

Bridge ID: MN-IC-LC-HPC-2	Bridge Length: 153.6 ft (46.8 m)	Bridge Age: 10.2 months
Bridge Number: 25036	Bridge Width: 42 ft (12.8 m)	Crack Density: 0.165 m/m ²
Bridge Location: S.B TH 52 over Little Cannon River	Skew: 0°	
Construction Date: 7/6/2017	Number of Spans: 1	
Crack Survey Date: 5/10/2018	Number of Placements: 1	

Figure E.7: Crack Map for MN-IC-LC-HPC-2 (Survey 1)

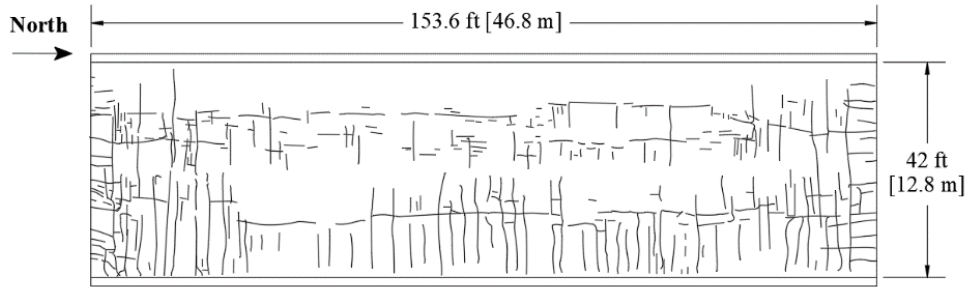

Bridge ID: MN-IC-LC-HPC-2 **Bridge Length:** 153.6 ft (46.8 m) **Bridge Age:** 22.9 months
Bridge Number: 25036 **Bridge Width:** 42 ft (12.8 m) **Crack Density:** 0.896 m/m²
Bridge Location: S.B TH 52 over Little Cannon River **Skew:** 0°
Construction Date: 7/6/2017 **Number of Spans:** 1
Crack Survey Date: 6/3/2019 **Number of Placements:** 1

Figure E.8: Crack Map for MN-IC-LC-HPC-2 (Survey 2)

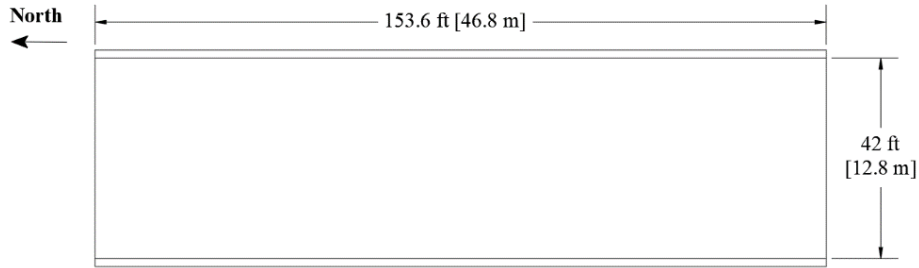

Bridge ID: MN-Control-2 **Bridge Length:** 153.6 ft (46.8 m) **Bridge Age:** 7.8 months
Bridge Number: 25032 **Bridge Width:** 42 ft (12.8 m) **Crack Density:** 0 m/m²
Bridge Location: N.B TH 52 over Little Cannon River **Skew:** 0°
Construction Date: 9/15/2017 **Number of Spans:** 1
Crack Survey Date: 5/10/2018 **Number of Placements:** 1
Crack Length: 0 ft

Figure E.9: Crack Map for MN-Control-2 (Survey 1)

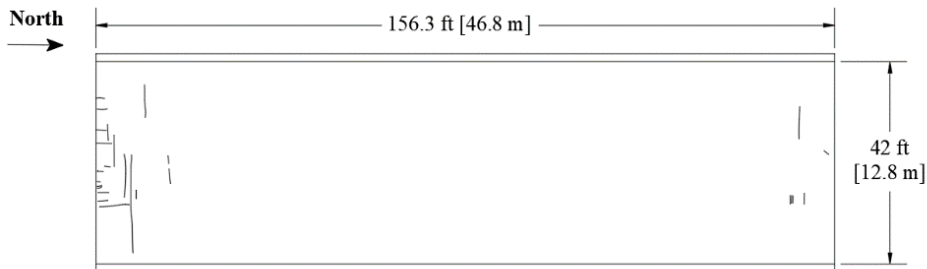

Bridge ID: MN-Control-2 **Bridge Length:** 153.6 ft (46.8 m) **Bridge Age:** 20.6 months
Bridge Number: 25032 **Bridge Width:** 42 ft (12.8 m) **Crack Density:** 0.050 m/m²
Bridge Location: S.B TH 52 over Little Cannon River **Skew:** 0°
Construction Date: 9/15/2017 **Number of Spans:** 1
Crack Survey Date: 6/3/2019 **Number of Placements:** 1
Crack Length: 98.4 ft

Figure E.10: Crack Map for MN-Control-2 (Survey 2)

Appendix E: Bridge Deck Survey Specifications

E.1 DESCRIPTION.

This specification covers the procedures and requirements to perform bridge deck surveys of reinforced concrete bridge decks.

E.2 SURVEY REQUIREMENTS.

E.2.1 Pre-Survey Preparation.

- (1) Prior to performing the crack survey, related construction documents need to be gathered to produce a scaled drawing of the bridge deck. The scale must be exactly 1 in. = 10 ft (for use with the scanning software), and the drawing only needs to include the boundaries of the deck surface.

NOTE 1 – In the event that it is not possible to produce a scaled drawing prior to arriving at the bridge deck, a hand-drawn crack map (1 in.= 10 ft) created on engineering paper using measurements taken in the field is acceptable.

- (2) The scaled drawing should also include compass and traffic directions in addition to deck stationing. A scaled 5 ft by 5 ft grid is also required to aid in transferring the cracks observed on the bridge deck to the scaled drawing. The grid shall be drawn separately and attached to the underside of the crack map such that the grid can easily be seen through the crack map.

NOTE 2 – Maps created in the field on engineering paper need not include an additional grid.

- (3) For curved bridges, the scaled drawing need not be curved, (i.e., the curve may be approximated using straight lines).

- (4) Coordinate with traffic control so that at least one side (or one lane) of the bridge can be closed during the time that the crack survey is being performed.

E.2.2 Preparation of Surface.

- (1) After traffic has been closed, station the bridge in the longitudinal direction at ten feet intervals. The stationing shall be done as close to the centerline as possible. For curved bridges, the stationing shall follow the curve.
- (2) Prior to beginning the crack survey, mark a 5 ft by 5 ft grid using lumber crayons or chalk on the portion of the bridge closed to traffic corresponding to the grid on the scaled drawing. Measure and document any drains, repaired areas, unusual cracking, or any other items of interest.
- (3) Starting with one end of the closed portion of the deck, using a lumber crayon or chalk, begin tracing cracks that can be seen while bending at the waist. After beginning to trace cracks, continue to the end of the crack, even if this includes portions of the crack that were not initially seen while bending at the waist. Cracks not attached to the crack being traced must not be marked unless they can be seen from waist height. Surveyors must return to the location where they started tracing a crack and continue the survey. Areas covered by sand or other debris need not be surveyed. Trace the cracks using a different color crayon than was used to mark the grid and stationing.
- (4) At least one person shall recheck the marked portion of the deck for any additional cracks. The goal is not to mark every crack on the deck, only those cracks that can initially be seen while bending at the waist.

NOTE 3 – An adequate supply of lumber crayons or chalk should be on hand for the survey. Crayon or chalk colors should be selected to be readily visible when used to mark the concrete.

E.2.3 Weather Limitations.

- (1) Surveys are limited to days when the expected temperature during the survey will not be below 60 °F.
- (2) Surveys are further limited to days that are forecasted to be at least mostly sunny for a majority of the day.
- (3) Regardless of the weather conditions, the bridge deck must be completely dry before the survey can begin.

E.3 BRIDGE SURVEY.

E.3.1 Crack Surveys.

Using the grid as a guide, transfer the cracks from the deck to the scaled drawing. Areas that are not surveyed should be marked on the scaled drawing. Spalls, regions of scaling, and other areas of special interest need not be included on the scale drawings but should be noted.

E.3.2 Delamination Survey.

At any time during or after the crack survey, bridge decks shall be checked for delamination. Any areas of delamination shall be noted and drawn on a separate drawing of the bridge. This second drawing need not be to scale.

E.3.3 Under Deck Survey.

Following the crack and delamination survey, the underside of the deck shall be examined, and any unusual or excessive cracking noted.



The central logo for the Kansas Department of Transportation. It features a dark blue circle with a yellow border. Inside the circle, the Latin motto "AD ASTRA PER ASPERA" is written in yellow on a banner above a semi-circle of yellow stars. Below the stars, the word "Kansas" is written in a large, white, serif font. Underneath "Kansas", the words "Department of Transportation" are written in a smaller, white, sans-serif font.

